

A close-up photograph of a person's mouth holding a glass of water with ice. The person's lips are painted red. The background is dark, making the subject stand out.

Universelle Klimatisierungersatzteile

Kompressoren & Zubehör

Expansionsventile

Kondensatoren

Verdampfer

Ventile

Lüfter & Gebläse

Druckschalter

Trockner

Thermostate

Fittinge

O-Ringe

Schläuche & Öle

Werkstattausrüstung

Inhaltsverzeichnis

Kompressoren	03-42			
Magnetkupplungen	43-63			
Kompressordichtungen	64-68			
Zylinderköpfe	69-74			
Spulen	75-80			
Kupplungsnahe	81-82			
Regelventile	83			
Expansionsventile	84-86			
Kondensatoren	87			
Innenraumgebläse	88-93			
Dasis Duo Power Fan	94-95			
Verdampfer	96			
Druckschalter	97-99			
Trockner	100			
Thermostate	101-102		AGB's	122
Fittinge	103-109			
O-Ringe	110-113			
Kühlmittelschläuche / Öle und Kältemittel	114	<p>Für Druckfehler keine Haftung. Die angegebenen Nummern dienen nur zu Vergleichszwecken. Bilder in diesem Katalog dienen ausschließlich der Veranschaulichung unserer Produkte. Rechtliche Ansprüche können daraus nicht abgeleitet werden. Die Vervielfältigung dieses Kataloges, teilweise oder ganz, einschließlich der Teilenummern und Abbildungen ist ohne die schriftliche Erlaubnis der AKS Dasis Dommermuth GmbH & Co. KG nicht zulässig. Die Verwendungsempfehlungen zu den in diesem Katalog aufgeführten Produkten beziehen sich auf den zum Zeitpunkt des Erscheinens dieses Kataloges bestehenden existierenden Fahrzeugbestand. Die AKS Dasis Dommermuth GmbH & Co. KG übernimmt keine Haftung für Änderungen, Ersetzungen oder Streichungen der Fahrzeuganwendungen oder Empfehlungen. Wir erkennen keine Forderungen auf Schadenersatz auf Grund der im Katalog erwähnten Angaben oder Bilder an.</p>		
Werkstattausrüstungen	115-119			

Kompressoren

Hersteller	Modell	Ø mm	Spannung (Volt)	Riemenscheibe	Zylinderkopf-ID	Dasis-Nr.
Bock	FKX40					851525N
Bock	FKX40					851526N
Bock	FKX40					851527N
Bock						851524N
Denso	10P15C					850700N
Denso	10PA15C lang					852028N
Denso	10PA17C kurz					852037N
Denso	10PA17C lang					852036N
Harrison	Harrison V5	120	12 Volt	PV 8		850324N
Harrison	Harrison V5	132	12 Volt	2 AG		850323N
Harrison	Harrison V5	132	12 Volt	2 AG		850326N
Harrison		125	24 Volt	1 AG		850322N
Harrison		125	12 Volt	2 AG		850459N
Harrison		125	24 Volt	2 AG		850321N
Harrison		152	12 Volt	1 AG		850461N
Harrison		152	24 Volt	1 AG		850319N
Harrison		178	24 Volt	1 AG		850462N
Sanden	SD507	125	12 Volt	2 AG	E	852135N
Sanden	SD507	125	24 Volt	2 AG	E	852136N
Sanden	SD508	119	12 Volt	PV 7	EG	852182N
Sanden	SD508	132	24 Volt	1 AG	FV	850559N
Sanden	SD508	132	12 Volt	2 AG	B	851105N
Sanden	SD508	132	12 Volt	2 AG	C	852181N
Sanden	SD508	132	12 Volt	2 AG	FL	850885N
Sanden	SD508	132	12 Volt	2 AG	N	851109N
Sanden	SD508	132	24 Volt	2 AG	B	852133N
Sanden	SD508	132	24 Volt	2 AG	C	852119N
Sanden	SD508	152	12 Volt	1 AG	C	852099N
Sanden	SD508	152	12 Volt	2 AG	B	850893N
Sanden	SD508	152	12 Volt	2 AG	M	851746N
Sanden	SD508	152	12 Volt	2 AG	N	852147N
Sanden	SD508	152	24 Volt	2 AG	B	852134N
Sanden	SD510	125	12 Volt	PV 6	UB	850886N
Sanden	SD510	132	12 Volt	2 AG	M	858454N
Sanden	SD510	132	12 Volt	2 AG	QH	850483N
Sanden	SD510	140	12 Volt	2 AG	QC	850883N
Sanden	SD510	152	12 Volt	2 AG	Q	850457N
Sanden	SD510HD	132	12 Volt	2 AG	M	850873N

Kompressoren

Hersteller	Modell	Ø mm	Spannung (Volt)	Riemenscheibe	Zylinderkopf-ID	Dasis-Nr.
Sanden	SD5H09	120	12 Volt	PV 5	EL	851475N
Sanden	SD5H09	125	12 Volt	2 AG	C	850050N
Sanden	SD5H09	125	12 Volt	2 AG	FL	850296N
Sanden	SD5H09	125	12 Volt	2 AG	M	850293N
Sanden	SD5H09	125	12 Volt	2 AG		851705N
Sanden	SD5H09	125	24 Volt	2 AG	EL	850302N
Sanden	SD5H09	132	12 Volt	2 AG	K	852166N
Sanden	SD5H11	125	12 Volt	2 AG	CB	850463N
Sanden	SD5H11	125	12 Volt	2 AG		852029N
Sanden	SD5H14	119	12 Volt	PV 7	EL	851481N
Sanden	SD5H14	119	12 Volt	PV 7	K	851479N
Sanden	SD5H14	119	12 Volt	PV 7	M	852167N
Sanden	SD5H14	125	12 Volt	1 AG		850262N
Sanden	SD5H14	125	12 Volt	1 AG		850263N
Sanden	SD5H14	125	12 Volt	1 AG		852004N
Sanden	SD5H14	132	12 Volt	2 AG	B	858485N
Sanden	SD5H14	132	12 Volt	2 AG	FG	850870N
Sanden	SD5H14	132	12 Volt	2 AG	JD	850317N
Sanden	SD5H14	132	12 Volt	2 AG	K	850879N
Sanden	SD5H14	132	12 Volt	2 AG	M	850414N
Sanden	SD5H14	132	12 Volt	2 AG	N	850884N
Sanden	SD5H14	132	12 Volt	2 AG		850301N
Sanden	SD5H14	132	24 Volt	2 AG	B	851727N
Sanden	SD5H14	132	24 Volt	2 AG	FL	850299N
Sanden	SD5H14	132	24 Volt	2 AG		850297N
Sanden	SD5H14	132	24 Volt	2 AG		850298N
Sanden	SD5H14	132	24 Volt	2 AG		850837N
Sanden	SD5H14	152	12 Volt	2 AG		850876N
Sanden	SD5H14	152	12 Volt	2 AG		852022N
Sanden	SD6V10	110	12 Volt	PV 5		850517N
Sanden	SD6V12	105	12 Volt	PV 6		850240N
Sanden	SD6V12	119	12 Volt	PV 5		850080N
Sanden	SD6V12	119	12 Volt	PV 6		850334N
Sanden	SD6V12	119	12 Volt	PV 6		850730N
Sanden	SD6V12	120	12 Volt	PV 6		850243N
Sanden	SD6V12	120	12 Volt	PV 6		851072N
Sanden	SD6V12	130	12 Volt	PV 6		850300N
Sanden	SD709	125	24 Volt	2 AG	ED	850551N

Kompressoren

Hersteller	Modell	Ø mm	Spannung (Volt)	Riemenscheibe	Zylinderkopf-ID	Dasis-Nr.
Sanden	SD7810	112	12 Volt	PV 6	P8	852111N
Sanden	SD7B10	100	12 Volt	PV 6		850306N
Sanden	SD7B10	110	12 Volt	PV 4	PB	851482N
Sanden	SD7B10	112	12 Volt	PV 6		850307N
Sanden	SD7B10	114	12 Volt	PV 6		853240N
Sanden	SD7B10	115	12 Volt	2 AG	PB	850327N
Sanden	SD7C16	118	12 Volt	PV 6		850254N
Sanden	SD7C16	120	12 Volt	PV 6		850280N
Sanden	SD7C16	122	12 Volt	PV 6		850444N
Sanden	SD7C16	128	12 Volt	PV 6		850476N
Sanden	SD7C16	135	12 Volt	2 AG		850477N
Sanden	SD7H13	119	12 Volt	PV 8		850644N
Sanden	SD7H13	120	12 Volt	PV 8		852003N
Sanden	SD7H13	125	12 Volt	2 AG	JE	850309N
Sanden	SD7H13	125	12 Volt	2 AG		853310N
Sanden	SD7H13	146	24 Volt	1 AG		851777N
Sanden	SD7H13	146	24 Volt	1 AG		852400N
Sanden	SD7H15		12 Volt	2 AG	WV	852188N
Sanden	SD7H15		12 Volt	PV 6	QC	852184N
Sanden	SD7H15	110	12 Volt	1 AG		853820N
Sanden	SD7H15	112	12 Volt	PV 4	WV	851786N
Sanden	SD7H15	112	12 Volt	PV 4		851763N
Sanden	SD7H15	112	12 Volt	PV 6		851890N
Sanden	SD7H15	113	12 Volt	PV 6		852192N
Sanden	SD7H15	117	12 Volt	PV 5		850004N
Sanden	SD7H15	119	12 Volt	PV 4		851769N
Sanden	SD7H15	119	12 Volt	PV 5		850484N
Sanden	SD7H15	119	12 Volt	PV 6		850481N
Sanden	SD7H15	119	12 Volt	PV 6	GN	850831N
Sanden	SD7H15	119	12 Volt	PV 6	KG	852116N
Sanden	SD7H15	119	12 Volt	PV 8	GH	851707N
Sanden	SD7H15	119	12 Volt	PV 8	GH	852097N
Sanden	SD7H15	119	12 Volt	PV 8	GH	852178N
Sanden	SD7H15	119	12 Volt	PV 8	GQ	852085N
Sanden	SD7H15	119	12 Volt	PV 8	GQ	852092N
Sanden	SD7H15	119	12 Volt	PV 8	GQ	852155N
Sanden	SD7H15	119	12 Volt	PV 8	GSA	852156N
Sanden	SD7H15	119	12 Volt	PV 8	GV	850887N

Kompressoren

Hersteller	Modell	Ø mm	Spannung (Volt)	Riemen-scheibe	Zylinder-kopf-ID	Dasis-Nr.
Sanden	SD7H15	119	12 Volt	PV 8	GV	852082N
Sanden	SD7H15	119	12 Volt	PV 8	GWA	852127N
Sanden	SD7H15	119	12 Volt	PV 8	JD	852168N
Sanden	SD7H15	119	12 Volt	PV 8	JE	851711N
Sanden	SD7H15	119	12 Volt	PV 8	JE	852117N
Sanden	SD7H15	119	12 Volt	PV 8	JE	852154N
Sanden	SD7H15	119	12 Volt	PV 8	JO	851734N
Sanden	SD7H15	119	12 Volt	PV 8	KCA	852089N
Sanden	SD7H15	119	12 Volt	PV 8	KCA	852180N
Sanden	SD7H15	119	12 Volt	PV 8	KG	850308N
Sanden	SD7H15	119	12 Volt	PV 8	KG	852176N
Sanden	SD7H15	119	12 Volt	PV 8	MD	851487N
Sanden	SD7H15	119	12 Volt	PV 8	MDA	852157N
Sanden	SD7H15	119	12 Volt	PV 8	MJ	852186N
Sanden	SD7H15	119	12 Volt	PV 8	MJA	852126N
Sanden	SD7H15	119	12 Volt	PV 8	MJA	852189N
Sanden	SD7H15	119	12 Volt	PV 8	OB	850304N
Sanden	SD7H15	119	12 Volt	PV 8	WH	852161N
Sanden	SD7H15	119	12 Volt	PV 8	WH	852169N
Sanden	SD7H15	119	12 Volt	PV 8	WJ	852162N
Sanden	SD7H15	119	12 Volt	PV 8		851701N
Sanden	SD7H15	119	12 Volt	PV 8		851716N
Sanden	SD7H15	119	12 Volt	PV 8		851768N
Sanden	SD7H15	119	12 Volt	PV 8		852142N
Sanden	SD7H15	119	12 Volt	PV 8		852148N
Sanden	SD7H15	119	12 Volt	PV 8		852149N
Sanden	SD7H15	119	24 Volt	PV 8	GV	852112N
Sanden	SD7H15	119	24 Volt	PV 8	JD	852094N
Sanden	SD7H15	119	24 Volt	PV 8	JE	850634N
Sanden	SD7H15	119	24 Volt	PV 8	KG	851492N
Sanden	SD7H15	119	24 Volt	PV 8	WK	850749N
Sanden	SD7H15	119	24 Volt	PV 8		851073N
Sanden	SD7H15	119	24 Volt	PV 8		851764N
Sanden	SD7H15	120	24 Volt	1 AG	VE	850626N
Sanden	SD7H15	120	12 Volt	PV 4		851772N
Sanden	SD7H15	120	12 Volt	PV 6	MD	852087N
Sanden	SD7H15	120	12 Volt	PV 6		851713N
Sanden	SD7H15	120	12 Volt	PV 7		853330N

Kompressoren

Hersteller	Modell	Ø mm	Spannung (Volt)	Riemenscheibe	Zylinderkopf-ID	Dasis-Nr.
Sanden	SD7H15	120	12 Volt	PV 7		853560N
Sanden	SD7H15	120	12 Volt	PV 8	JD	851785N
Sanden	SD7H15	120	24 Volt	PV 8	FZ	850671N
Sanden	SD7H15	123	24 Volt	PV 5	SO	850669N
Sanden	SD7H15	123	12 Volt	PV 7	OD	852103N
Sanden	SD7H15	125	12 Volt	1 AG	GV	852107N
Sanden	SD7H15	125	12 Volt	1 AG	GV	852179N
Sanden	SD7H15	125	12 Volt	1 AG	JE	852165N
Sanden	SD7H15	125	12 Volt	1 AG		851706N
Sanden	SD7H15	125	12 Volt	2 AG	GQ	852091N
Sanden	SD7H15	125	12 Volt	2 AG	GV	852081N
Sanden	SD7H15	125	12 Volt	2 AG	GV	852098N
Sanden	SD7H15	125	12 Volt	2 AG	JD	852086N
Sanden	SD7H15	125	12 Volt	2 AG	OB	852159N
Sanden	SD7H15	125	12 Volt	2 AG	SJA	851748N
Sanden	SD7H15	125	12 Volt	2 AG		850303N
Sanden	SD7H15	125	12 Volt	2 AG		852124N
Sanden	SD7H15	125	24 Volt	2 AG	GV	852104N
Sanden	SD7H15	125	24 Volt	2 AG		850851N
Sanden	SD7H15	125	12 Volt	PV 4		851041N
Sanden	SD7H15	125	12 Volt	PV 6	CB	852164N
Sanden	SD7H15	125	12 Volt	PV 6	CBA	852173N
Sanden	SD7H15	125	12 Volt	PV 6	GH	852101N
Sanden	SD7H15	125	12 Volt	PV 6	GH	852151N
Sanden	SD7H15	125	12 Volt	PV 6	GQ	852084N
Sanden	SD7H15	125	12 Volt	PV 6	GQ	852153N
Sanden	SD7H15	125	12 Volt	PV 6	GSA	852083N
Sanden	SD7H15	125	12 Volt	PV 6	GSA	852152N
Sanden	SD7H15	125	12 Volt	PV 6	GWA	852096N
Sanden	SD7H15	125	12 Volt	PV 6	JD	852131N
Sanden	SD7H15	125	12 Volt	PV 6	JE	852079N
Sanden	SD7H15	125	12 Volt	PV 6	MD	852129N
Sanden	SD7H15	125	12 Volt	PV 6	UK	852187N
Sanden	SD7H15	125	12 Volt	PV 6	WJ	852171N
Sanden	SD7H15	125	12 Volt	PV 6		851990N
Sanden	SD7H15	125	12 Volt	PV 6		852125N
Sanden	SD7H15	125	12 Volt	PV 6		852650N
Sanden	SD7H15	125	12 Volt	PV 6		854070N

Kompressoren

Hersteller	Modell	Ø mm	Spannung (Volt)	Riemen-scheibe	Zylinder-kopf-ID	Dasis-Nr.
Sanden	SD7H15	125	12 Volt	PV 6		854080N
Sanden	SD7H15	125	12 Volt	PV 6		854090N
Sanden	SD7H15	126	12 Volt	1 AG	GQ	852144N
Sanden	SD7H15	130	12 Volt	2 AG	UK	852078N
Sanden	SD7H15	130	12 Volt	PV 6		850911N
Sanden	SD7H15	130	12 Volt	PV 7	GF	852095N
Sanden	SD7H15	130	12 Volt	PV 7		851071N
Sanden	SD7H15	130	12 Volt	PV 8	WV	852121N
Sanden	SD7H15	130	12 Volt	PV 8	WV	852132N
Sanden	SD7H15	132	12 Volt	1 AG	QS	850811N
Sanden	SD7H15	132	24 Volt	1 AG	QC	850658N
Sanden	SD7H15	132	12 Volt	2 AG	CB	850312N
Sanden	SD7H15	132	12 Volt	2 AG	GH	852172N
Sanden	SD7H15	132	12 Volt	2 AG	JD	851738N
Sanden	SD7H15	132	12 Volt	2 AG	JD	852143N
Sanden	SD7H15	132	12 Volt	2 AG	JD	852177N
Sanden	SD7H15	132	12 Volt	2 AG	JDA	852174N
Sanden	SD7H15	132	12 Volt	2 AG	JE	852115N
Sanden	SD7H15	132	12 Volt	2 AG	KCA	852138N
Sanden	SD7H15	132	12 Volt	2 AG	KG	850875N
Sanden	SD7H15	132	12 Volt	2 AG	MD	852146N
Sanden	SD7H15	132	12 Volt	2 AG	MJA	852158N
Sanden	SD7H15	132	12 Volt	2 AG	PJE	852123N
Sanden	SD7H15	132	12 Volt	2 AG	QC	850625N
Sanden	SD7H15	132	12 Volt	2 AG	SJA	852175N
Sanden	SD7H15	132	12 Volt	2 AG	WJ	852163N
Sanden	SD7H15	132	12 Volt	2 AG	WV	852093N
Sanden	SD7H15	132	12 Volt	2 AG		850419N
Sanden	SD7H15	132	12 Volt	2 AG		850622N
Sanden	SD7H15	132	12 Volt	2 AG		850666N
Sanden	SD7H15	132	12 Volt	2 AG		851406N
Sanden	7H15	132	12 Volt	2 AG		850534N
Sanden	SD7H15	132	12 Volt	2 AG		851698N
Sanden	SD7H15	132	12 Volt	2 AG		853430N
Sanden	SD7H15	132	24 Volt	2 AG	JD	851718N
Sanden	SD7H15	132	24 Volt	2 AG	JD	852128N
Sanden	SD7H15	132	24 Volt	2 AG	JE	850554N
Sanden	SD7H15	132	24 Volt	2 AG	JE	850651N

Kompressoren

Hersteller	Modell	Ø mm	Spannung (Volt)	Riemenscheibe	Zylinderkopf-ID	Dasis-Nr.
Sanden	SD7H15	132	24 Volt	2 AG	JE	852118N
Sanden	SD7H15	132	24 Volt	2 AG	MD	852185N
Sanden	SD7H15	132	24 Volt	2 AG	MD	858270N
Sanden	SD7H15	132	24 Volt	2 AG	SO	850663N
Sanden	SD7H15	132	24 Volt	2 AG	WV	850612N
Sanden	SD7H15	132	24 Volt	2 AG		850257N
Sanden	SD7H15	132	24 Volt	2 AG		850315N
Sanden	SD7H15	132	24 Volt	2 AG		850838N
Sanden	SD7H15	132	24 Volt	2 AG		852122N
Sanden	SD7H15	132	24 Volt	PV 6	KF	850586N
Sanden	SD7H15	132	12 Volt	PV 8	KCA	851729N
Sanden	SD7H15	132	24 Volt	PV 8	WV	850659N
Sanden	SD7H15	132	24 Volt	PV 8	WV	850670N
Sanden	SD7H15	133	12 Volt	PV 8	JD	851756N
Sanden	SD7H15	133	12 Volt	PV 8	KC	850889N
Sanden	SD7H15	133	12 Volt	PV 8	WV	852102N
Sanden	SD7H15	133	12 Volt	PV 8		851774N
Sanden	SD7H15	133	24 Volt	PV 8	GK	850617N
Sanden	SD7H15	133	24 Volt	PV 8		851721N
Sanden	SD7H15	133	24 Volt	PV 8		851725N
Sanden	SD7H15	135	12 Volt	1 AG		851741N
Sanden	SD7H15	137	12 Volt	PV 6		851590N
Sanden	SD7H15	140	12 Volt	PV 5		853570N
Sanden	SD7H15	140	24 Volt	PV 7	SB	851822N
Sanden	SD7H15	144	12 Volt	2 AG		852210N
Sanden	SD7H15	145	12 Volt	PV 4		851765N
Sanden	SD7H15	150	12 Volt	2 AG	KG	851719N
Sanden	SD7H15	152	12 Volt	2 AG	GV	852145N
Sanden	SD7H15	152	24 Volt	2 AG	GV	852110N
Sanden	SD7H15	152	24 Volt	2 AG	MD	851751N
Sanden	SD7H15	152	24 Volt	PV 8	GK	850619N
Sanden	SD7H15	152	24 Volt	PV 8		851731N
Sanden	SD7H15	153	24 Volt	1 AG	GV	852109N
Sanden	SD7H15	153	12 Volt	PV 8	GV	852108N
Sanden	SD7H15	153	12 Volt	PV 8	JE	852141N
Sanden	SD7H15	153	24 Volt	PV 8	GK	850615N
Sanden	SD7H15	158	12 Volt	1 AG	GV	852105N
Sanden	SD7H15	158	24 Volt	1 AG	GV	852106N

Kompressoren

Hersteller	Modell	Ø mm	Spannung (Volt)	Riemen-scheibe	Zylinder-kopf-ID	Dasis-Nr.
Sanden	SD7H15	158	12 Volt	2 AG	CB	850636N
Sanden	SD7H15	158	12 Volt	2 AG		850891N
Sanden	SD7H15	176	24 Volt	PV 8	WV	852139N
Sanden	SD7H15	180	12 Volt	PV 8	WV	851892N
Sanden	SD7H15-FLX7	135	12 Volt	2 AG	GV	851717N
Sanden	SD7H15-FLX7	135	24 Volt	2 AG	GV	851723N
Sanden	SD7H15HD	125	12 Volt	2 AG		850896N
Sanden	SD7H15HD	132	12 Volt	2 AG	GB	851699N
Sanden	SD7H15HD	132	12 Volt	2 AG	JD	858020N
Sanden	SD7H15HD	132	12 Volt	2 AG		851408N
Sanden	SD7H15HD	132	24 Volt	2 AG	FZ	850552N
Sanden	SD7H15HD	132	24 Volt	2 AG		850585N
Sanden	SD7H15HD	138	12 Volt	1 AG	GK	850897N
Sanden	SD7H15HD	138	12 Volt	1 AG	KC	850878N
Sanden	SD7H15HD	138	24 Volt	1 AG	GK	851736N
Sanden	SD7H15HD	140	12 Volt	2 AG	QC	850883N
Sanden	SD7H15HD	140	12 Volt	2 AG	GV	851733N
Sanden	SD7H15HD	152	24 Volt	1 AG	GK	850596N
Sanden	SD7H15HD	152	24 Volt	1 AG		851737N
Sanden	SD7H15HD	152	12 Volt	2 AG	MD	850874N
Sanden	SD7H15HD	152	12 Volt	PV 8	MD	851722N
Sanden	SD7H15HD	152	24 Volt	PV 8	MD	851749N
Seiko -Seiki		120	12 Volt	PV 4		851999N
Seiko-Seiki	121DS1	132	12 Volt	2 AG		850345N
Seiko-Seiki	121DS3	119	12 Volt	PV 8		850346N
Seiko-Seiki	SS10M2	110	12 Volt	PV 4		850354N
Seiko-Seiki	SS121DS1	120	12 Volt	PV 8		850347N
Seiko-Seiki	SS121DS3	132	12 Volt	2 AG		858387N
Seltec	TM08	136	12 Volt	2 AG		851089N
Seltec	TM08	136	24 Volt	PV 3		852012N
Seltec	TM13	123	12 Volt	PV 8		850818N
Seltec	TM13	123	24 Volt	PV 8		850819N
Seltec	TM13	135	24 Volt	2 AG		850817N
Seltec	TM14-15	123	12 Volt	PV 8		850824N
Seltec	TM14-15	123	24 Volt	PV 8		850825N
Seltec	TM14-15	135	12 Volt	2 AG		850823N
Seltec	TM14-15	135	24 Volt	2 AG		850344N
Seltec	TM15	119	12 Volt	PV 6		852294N

Kompressoren

Hersteller	Modell	Ø mm	Spannung (Volt)	Riemenscheibe	Zylinderkopf-ID	Dasis-Nr.
Seltec	TM15	119	12 Volt	PV 8		852300N
Seltec	TM15	119	12 Volt	PV 8		852303N
Seltec	TM15	125	12 Volt	2 AG		852298N
Seltec	TM15	125	12 Volt	2 AG		852299N
Seltec	TM15	125	12 Volt	2 AG		852301N
Seltec	TM15	135	12 Volt	2 AG		852296N
Seltec	TM15	135	24 Volt	2 AG		852302N
Seltec	TM-15HD	135	24 Volt	2 AG	KH	850610N
Seltec	TM16	119	12 Volt	1 AG		852323N
Seltec	TM16	119	12 Volt	PV 6		852305N
Seltec	TM16	119	12 Volt	PV 6		852314N
Seltec	TM16	119	12 Volt	PV 8		852310N
Seltec	TM16	119	12 Volt	PV 8		852311N
Seltec	TM16	119	12 Volt	PV 8		852312N
Seltec	TM16	119	12 Volt	PV 8		852317N
Seltec	TM16	119	12 Volt	PV 8		852318N
Seltec	TM16	119	12 Volt	PV 8		852319N
Seltec	TM16	123	24 Volt	PV 8		850834N
Seltec	TM16	125	12 Volt	2 AG		852309N
Seltec	TM16	125	12 Volt	2 AG		852315N
Seltec	TM16	126	12 Volt	1 AG		852316N
Seltec	TM16	135	12 Volt	2 AG		852304N
Seltec	TM16	135	12 Volt	2 AG		852306N
Seltec	TM16	135	12 Volt	2 AG		852307N
Seltec	TM16	135	12 Volt	2 AG		852313N
Seltec	TM16	135	12 Volt	2 AG		852321N
Seltec	TM16	135	12 Volt	2 AG		852322N
Seltec	TM16	135	24 Volt	2 AG		850546N
Seltec	TM16	136	24 Volt	2 AG		858260N
Seltec	TM16	152	12 Volt	2 AG		852308N
Seltec	TM21	127	12 Volt	1 AG		852329N
Seltec	TM21	127	12 Volt	PV 8		852327N
Seltec	TM21	137	12 Volt	PV 6		852328N
Seltec	TM21	137	12 Volt	PV 8		852325N
Seltec	TM21	137	24 Volt	PV 8		852326N
Seltec	TM21	141	12 Volt	1 AG		852295N
Seltec	TM21	145	12 Volt	2 AG		852324N
Seltec	TM31	152	24 Volt	1 AG		852338N

Kompressoren

Hersteller	Modell	Ø mm	Spannung (Volt)	Riemenscheibe	Zylinderkopf-ID	Dasis-Nr.
Seltec	TM31	152	12 Volt	2 AG		852332N
Seltec	TM31	152	24 Volt	2 AG		850329N
Seltec	TM31	155	12 Volt	2 AG		852333N
Seltec	TM31	158	24 Volt	2 AG		852334N
Seltec	TM31					852331N
York	206		12 Volt			850349N
York	206		12 Volt			850351N
York	209/210		12 Volt			850353N
York	T209/210L					850352N

Kompressoren

Sanden
SD7H15
Ø mm: 117
12 Volt
PV 5



850004N

Sanden
SD5H09
Ø mm: 125
12 Volt
PV 2
Zylinderkopf: C
Ohrbefestigung



850050N

Sanden
SD6V12
Ø mm: 119
12 Volt
PV 5



850080N

Sanden
SD6V12
Ø mm: 105
12 Volt
PV 6



850240N

Sanden
SD6V12
Ø mm: 120
12 Volt
PV 6



850243N

Sanden
SD7C16
Ø mm: 118
12 Volt
PV 6



850254N

Sanden
SD7H15
Ø mm: 132
24 Volt
PV 2
Ohrbefestigung



850257N

Sanden
SD5H14
Ø mm: 125
12 Volt
PV 10



850262N

Sanden
SD5H14
Ø mm: 125
12 Volt
PV 10



850263N

Sanden
SD7C16
Ø mm: 120
12 Volt
PV 6



850280N

Sanden
SD5H09
Ø mm: 125
12 Volt
PV 2
Zylinderkopf: M
Ohrbefestigung



850293N

Sanden
SD5H09
Ø mm: 125
12 Volt
PV 2
Zylinderkopf: FL
Ohrbefestigung



850296N

Kompressoren

Sanden
SD5H14
Ø mm: 132
24 Volt
PV 2



850297N

Sanden
SD5H14
Ø mm: 132
24 Volt
PV 2



850298N

Sanden
SD5H14
Ø mm: 132
24 Volt
PV 2
Zylinderkopf: FL
Ohrbefestigung



850299N

Sanden
SD6V12
Ø mm: 130
12 Volt
PV 6



850300N

Sanden
SD5H14
Ø mm: 132
12 Volt
PV 2



850301N

Sanden
SD5H09
Ø mm: 125
24 Volt
PV 2
Zylinderkopf: EL
Ohrbefestigung



850302N

Sanden
SD7H15
Ø mm: 125
12 Volt
PV 2
Ohrbefestigung



850303N

Sanden
SD7H15
Ø mm: 119
12 Volt
PV 8
Zylinderkopf: OB
Ohrbefestigung

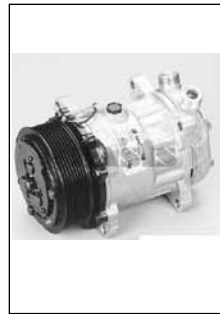

850304N

Sanden
SD7B10
Ø mm: 100
12 Volt
PV 6



850306N

Sanden
SD7B10
Ø mm: 112
12 Volt
PV 6



850307N

Sanden
SD7H15
Ø mm: 119
12 Volt
PV 8
Zylinderkopf: KG
Ohrbefestigung



850308N

Sanden
SD7H13
Ø mm: 125
12 Volt
PV 2
Zylinderkopf: JE
Ohrbefestigung



850309N

Kompressoren

Sanden
SD7H15
Ø mm: 132
12 Volt
PV 2
Zylinderkopf: CB
Ohrbefestigung



850312N

Sanden
SD7H15
Ø mm: 132
24 Volt
PV 2



850315N

Sanden
SD5H14
Ø mm: 132
12 Volt
PV 2
Zylinderkopf: JD
Ohrbefestigung



850317N

Harrison
Ø mm: 152
24 Volt
PV 1



850319N

Harrison
Ø mm: 125
24 Volt
PV 2



850321N

Harrison
Ø mm: 125
24 Volt
PV 1



850322N

Harrison
Harrison V5
Ø mm: 132
12 Volt
PV 2



850323N

Harrison
Harrison V5
Ø mm: 120
12 Volt
PV 8

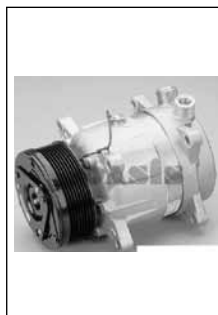

850324N

Harrison
Harrison V5
Ø mm: 132
12 Volt
PV 2



850326N

Sanden
SD7B10
Ø mm: 115
12 Volt
PV 2
Zylinderkopf: PB
Ohrbefestigung



850327N

Seltec
TM31
Ø mm: 152
24 Volt
PV 2



850329N

Sanden
SD6V12
Ø mm: 119
12 Volt
PV 6

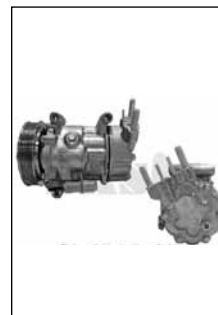

850334N

Kompressoren

Seltec
TM14-15
Ø mm: 135
24 Volt
PV 2



850344N

Seiko-Seiki
121DS1
Ø mm: 132
12 Volt
PV 2



850345N

Seiko-Seiki
121DS3
Ø mm: 119
12 Volt
PV 8



850346N

Seiko-Seiki
SS121DS1
Ø mm: 120
12 Volt
PV 8



850347N

York
206
12 Volt



850349N

York
206
12 Volt



850351N

York
T209/210L



850352N

York
209/210
12 Volt



850353N

Seiko-Seiki
SS10M2
Ø mm: 110
12 Volt
PV 4



850354N

Sanden
SD5H14
Ø mm: 132
12 Volt
PV 2
Zylinderkopf: M
Ohrbefestigung



850414N

Sanden
SD7H15
Ø mm: 132
12 Volt
PV 2



850419N

Sanden
SD7C16
Ø mm: 122
12 Volt
PV 6



850444N

Kompressoren

Sanden
SD510
Ø mm: 152
12 Volt
PV 2
Zylinderkopf: Q
Ohrbefestigung



850457N

Harrison
Ø mm: 125
12 Volt
PV 2



850459N

Harrison
Ø mm: 152
12 Volt
PV 1



850461N

Harrison
Ø mm: 178
24 Volt
PV 1



850462N

Sanden
SD5H11
Ø mm: 125
12 Volt
PV 2
Zylinderkopf: CB
Ohrbefestigung



850463N

Sanden
SD7C16
Ø mm: 128
12 Volt
PV 6

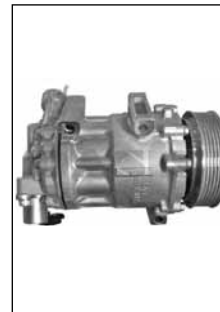

850476N

Sanden
SD7C16
Ø mm: 135
12 Volt
PV 2



850477N

Sanden
Sanden 7H15
Ø mm: 119
12 Volt
PV 6



850481N

Sanden
SD510
Ø mm: 132
12 Volt
PV 2
Zylinderkopf: QH
Ohrbefestigung



850483N

Sanden
Sanden 7H15
Ø mm: 119
12 Volt
PV 5



850484N

Sanden
SD6V10
Ø mm: 110
12 Volt
PV 5



850517N

Sanden
Sanden 7H15
Ø mm: 132
12 Volt
PV 2



850534N

Kompressoren

Seltec
TM16
Ø mm: 135
24 Volt
PV 2



850546N

Sanden
SD709
Ø mm: 125
24 Volt
PV 2
Zylinderkopf: ED
Ohrbefestigung



850551N

Sanden
SD7H15HD
Ø mm: 132
24 Volt
PV 2
Zylinderkopf: FZ
Ohrbefestigung



850552N

Sanden
SD7H15
Ø mm: 132
24 Volt
PV 2
Zylinderkopf: JE
Ohrbefestigung



850554N

Sanden
SD508
Ø mm: 132
24 Volt
PV 1
Zylinderkopf: FV
Ohrbefestigung



850559N

Sanden
SD7H15HD
Ø mm: 132
24 Volt
PV 2



850585N

Sanden
SD7H15
Ø mm: 132
24 Volt
PV 6
Zylinderkopf: KF
Ohrbefestigung



850586N

Sanden
SD7H15HD
Ø mm: 152
24 Volt
PV 1
Zylinderkopf: GK
Ohrbefestigung



850596N

Seltec
TM-15HD
Ø mm: 135
24 Volt
PV 2
Zylinderkopf: KH
Ohrbefestigung



850610N

Sanden
SD7H15
Ø mm: 132
24 Volt
PV 2
Zylinderkopf: WV
Ohrbefestigung



850612N

Sanden
SD7H15
Ø mm: 153
24 Volt
PV 8
Zylinderkopf: GK
Ohrbefestigung



850615N

Sanden
SD7H15
Ø mm: 133
24 Volt
PV 8
Zylinderkopf: GK
Kurzbefestigung



850617N

Kompressoren

Sanden
SD7H15
Ø mm: 152
24 Volt
PV 8
Zylinderkopf: GK
Kurzbelegung



850619N

Sanden
SD7H15
Ø mm: 132
12 Volt
PV 2



850622N

Sanden
SD7H15
Ø mm: 132
12 Volt
PV 2
Zylinderkopf: QC
Ohrbefestigung



850625N

Sanden
SD7H15
Ø mm: 120
24 Volt
PV 10
Zylinderkopf: VE
Ohrbefestigung



850626N

Sanden
SD7H15
Ø mm: 119
24 Volt
PV 8
Zylinderkopf: JE
Ohrbefestigung



850634N

Sanden
SD7H15
Ø mm: 158
12 Volt
PV 2
Zylinderkopf: CB
Ohrbefestigung



850636N

Sanden
SD7H13
Ø mm: 119
12 Volt
PV 8



850644N

Sanden
SD7H15
Ø mm: 132
24 Volt
PV 2
Zylinderkopf: JE
Ohrbefestigung



850651N

Sanden
SD7H15
Ø mm: 132
24 Volt
PV 1
Zylinderkopf: QC
Ohrbefestigung



850658N

Sanden
SD7H15
Ø mm: 132
24 Volt
PV 8
Zylinderkopf: WV
Ohrbefestigung



850659N

Sanden
SD7H15
Ø mm: 132
24 Volt
PV 2
Zylinderkopf: SO
Ohrbefestigung



850663N

Sanden
SD7H15
Ø mm: 132
12 Volt
PV 2



850666N

Kompressoren

Sanden
SD7H15
Ø mm: 123
24 Volt
PV 5
Zylinderkopf: SO
Kurzbefestigung



850669N

Sanden
SD7H15
Ø mm: 132
24 Volt
PV 8
Zylinderkopf: WV
Kurzbefestigung



850670N

Sanden
SD7H15
Ø mm: 120
24 Volt
PV 8
Zylinderkopf: FZ
Ohrbefestigung



850671N

Denso
10P15C



850700N

Sanden
SD6V12
Ø mm: 119
12 Volt
PV 6



850730N

Sanden
SD7H15
Ø mm: 119
24 Volt
PV 8
Zylinderkopf: WK
Kurzbefestigung



850749N

Sanden
SD7H15
Ø mm: 132
12 Volt
PV 1
Zylinderkopf: QS
Ohrbefestigung



850811N

Seltec
TM13
Ø mm: 135
24 Volt
PV 2



850817N

Seltec
TM13
Ø mm: 123
12 Volt
PV 8



850818N

Seltec
TM13
Ø mm: 123
24 Volt
PV 8



850819N

Seltec
TM14-15
Ø mm: 135
12 Volt
PV 2



850823N

Seltec
TM14-15
Ø mm: 123
12 Volt
PV 8



850824N

Kompressoren

Seltec
TM14-15
Ø mm: 123
24 Volt
PV 8



850825N

Sanden
SD7H15
Ø mm: 119
12 Volt
PV 6
Zylinderkopf: GN
Kurzbefestigung



850831N

Seltec
TM16
Ø mm: 123
24 Volt
PV 8



850834N

Sanden
SD5H14
Ø mm: 132
24 Volt
PV 2



850837N

Sanden
SD7H15
Ø mm: 132
24 Volt
PV 2



850838N

Sanden
SD7H15
Ø mm: 125
24 Volt
PV 2



850851N

Sanden
SD5H14
Ø mm: 132
12 Volt
PV 2
Zylinderkopf: FG
Ohrbefestigung



850870N

Sanden
SD510HD
Ø mm: 132
12 Volt
PV 2
Zylinderkopf: M
Ohrbefestigung



850873N

Sanden
SD7H15HD
Ø mm: 152
12 Volt
PV 2
Zylinderkopf: MD
Ohrbefestigung



850874N

Sanden
SD7H15
Ø mm: 132
12 Volt
PV 2
Zylinderkopf: KG
Ohrbefestigung



850875N

Sanden
SD5H14
Ø mm: 152
12 Volt
PV 2



850876N

Sanden
SD7H15HD
Ø mm: 138
12 Volt
PV 1
Zylinderkopf: KC
Ohrbefestigung



850878N

Kompressoren

Sanden
SD5H14
Ø mm: 132
12 Volt
PV 2
Zylinderkopf: K
Ohrbefestigung



850879N

Sanden
SD510
7H15HD
Ø mm: 140
12 Volt
PV 2
Zylinderkopf: QC
Ohrbefestigung



850883N

Sanden
SD5H14
Ø mm: 132
12 Volt
PV 2
Zylinderkopf: N
Ohrbefestigung



850884N

Sanden
SD508
Ø mm: 132
12 Volt
PV 2
Zylinderkopf: FL
Ohrbefestigung



850885N

Sanden
SD510
Ø mm: 125
12 Volt
PV 6
Zylinderkopf: UB
Ohrbefestigung



850886N

Sanden
SD7H15
Ø mm: 119
12 Volt
PV 8
Zylinderkopf: GV
Ohrbefestigung



850887N

Sanden
SD7H15
Ø mm: 133
12 Volt
PV 8
Zylinderkopf: KC
Ohrbefestigung



850889N

Sanden
SD7H15
Ø mm: 158
12 Volt
PV 2



850891N

Sanden
SD508
Ø mm: 152
12 Volt
PV 2
Zylinderkopf: B
Ohrbefestigung



850893N

Sanden
SD7H15HD
Ø mm: 125
12 Volt
PV 2



850896N

Sanden
SD7H15HD
Ø mm: 138
12 Volt
PV 1
Zylinderkopf: GK
Ohrbefestigung

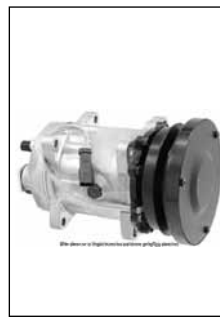

850897N

Sanden
SD7H15
Ø mm: 130
12 Volt
PV 6
Spezialbefestigung



850911N

Kompressoren

Sanden
Sanden 7H15
Ø mm: 125
12 Volt
PV 4



851041N

Sanden
SD7H15
Ø mm: 130
12 Volt
PV 7

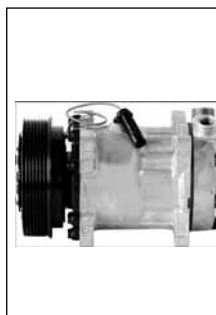

851071N

Sanden
SD6V12
Ø mm: 120
12 Volt
PV 6



851072N

Sanden
SD7H15
Ø mm: 119
24 Volt
PV 8



851073N

Seltec
TM08
Ø mm: 136
12 Volt
PV 2



851089N

Sanden
SD508
Ø mm: 132
12 Volt
PV 2
Zylinderkopf: B
Ohrbefestigung



851105N

Sanden
SD508
Ø mm: 132
12 Volt
PV 2
Zylinderkopf: N
Ohrbefestigung



851109N

Sanden
SD7H15
Ø mm: 132
12 Volt
PV 2



851406N

Sanden
SD7H15HD
Ø mm: 132
12 Volt
PV 2



851408N

Sanden
SD5H09
Ø mm: 120
12 Volt
PV 5
Zylinderkopf: EL
Ohrbefestigung



851475N

Sanden
SD5H14
Ø mm: 119
12 Volt
PV 7
Zylinderkopf: K
Ohrbefestigung



851479N

Sanden
SD5H14
Ø mm: 119
12 Volt
PV 7
Zylinderkopf: EL
Ohrbefestigung



851481N

Kompressoren

Sanden
SD7B10
Ø mm: 110
12 Volt
PV 4
Zylinderkopf: PB
Ohrbefestigung



851482N

Sanden
SD7H15
Ø mm: 119
12 Volt
PV 8
Zylinderkopf: MD
Ohrbefestigung



851487N

Sanden
SD7H15
Ø mm: 119
24 Volt
PV 8
Zylinderkopf: KG
Ohrbefestigung



851492N

Bock



851524N

Bock
FKX40



851525N

Bock
FKX40



851526N

Bock
FKX40



851527N

Sanden
SD7H15
Ø mm: 137
12 Volt
PV 6



851590N

Sanden
SD7H15
Ø mm: 132
12 Volt
PV 2



851698N

Sanden
SD7H15HD
Ø mm: 132
12 Volt
PV 2
Zylinderkopf: GB
Ohrbefestigung



851699N

Sanden
SD7H15
Ø mm: 119
12 Volt
PV 8



851701N

Sanden
SD5H09
Ø mm: 125
12 Volt
PV 2



851705N

Kompressoren

Sanden
SD7H15
Ø mm: 125
12 Volt
PV 10



851706N

Sanden
SD7H15
Ø mm: 119
12 Volt
PV 8
Zylinderkopf: GH
Kurzbefestigung



851707N

Sanden
SD7H15
Ø mm: 119
12 Volt
PV 8
Zylinderkopf: JE
Ohrbefestigung



851711N

Sanden
SD7H15
Ø mm: 120
12 Volt
PV 6



851713N

Sanden
SD7H15
Ø mm: 119
12 Volt
PV 8



851716N

Sanden
SD7H15-FLX7
Ø mm: 135
12 Volt
PV 2
Zylinderkopf: GV
Ohrbefestigung



851717N

Sanden
SD7H15
Ø mm: 132
24 Volt
PV 2
Zylinderkopf: JD
Ohrbefestigung



851718N

Sanden
SD7H15
Ø mm: 150
12 Volt
PV 2
Zylinderkopf: KG
Ohrbefestigung



851719N

Sanden
SD7H15
Ø mm: 133
24 Volt
PV 8



851721N

Sanden
SD7H15HD
Ø mm: 152
12 Volt
PV 8
Zylinderkopf: MD
Kurzbefestigung



851722N

Sanden
SD7H15-FLX7
Ø mm: 135
24 Volt
PV 2
Zylinderkopf: GV
Ohrbefestigung



851723N

Sanden
SD7H15
Ø mm: 133
24 Volt
PV 8



851725N

Kompressoren

Sanden
SD5H14
Ø mm: 132
24 Volt
PV 2
Zylinderkopf: B
Ohrbefestigung



851727N

Sanden
SD7H15
Ø mm: 132
12 Volt
PV 8
Zylinderkopf: KCA
Kurzbefestigung

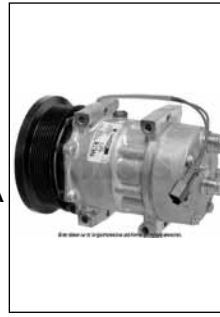

851729N

Sanden
SD7H15
Ø mm: 152
24 Volt
PV 8



851731N

Sanden
SD7H15HD
Ø mm: 140
12 Volt
PV 2
Zylinderkopf: GV
Ohrbefestigung



851733N

Sanden
SD7H15
Ø mm: 119
12 Volt
PV 8
Zylinderkopf: JO
Kurzbefestigung



851734N

Sanden
SD7H15HD
Ø mm: 138
24 Volt
PV 1
Zylinderkopf: GK
Ohrbefestigung



851736N

Sanden
SD7H15HD
Ø mm: 152
24 Volt
PV 1



851737N

Sanden
SD7H15
Ø mm: 132
12 Volt
PV 2
Zylinderkopf: JD
Ohrbefestigung



851738N

Sanden
SD7H15
Ø mm: 135
12 Volt
PV 1



851741N

Sanden
SD508
Ø mm: 152
12 Volt
PV 2
Zylinderkopf: M
Ohrbefestigung



851746N

Sanden
SD7H15
Ø mm: 125
12 Volt
PV 2
Zylinderkopf: SJA
Ohrbefestigung



851748N

Sanden
SD7H15HD
Ø mm: 152
24 Volt
PV 8
Zylinderkopf: MD
Kurzbefestigung



851749N

Kompressoren

Sanden
SD7H15
Ø mm: 152
24 Volt
PV 2
Zylinderkopf: MD
Ohrbefestigung



851751N

Sanden
SD7H15
Ø mm: 133
12 Volt
PV 8
Zylinderkopf: JD
Kurzbelegung



851756N

Sanden
SD7H15
Ø mm: 112
12 Volt
PV 4



851763N

Sanden
SD7H15
Ø mm: 119
24 Volt
PV 8



851764N

Sanden
SD7H15
Ø mm: 145
12 Volt
PV 4



851765N

Sanden
SD7H15
Ø mm: 119
12 Volt
PV 8



851768N

Sanden
SD7H15
Ø mm: 119
12 Volt
PV 4



851769N

Sanden
SD7H15
Ø mm: 120
12 Volt
PV 4



851772N

Sanden
SD7H15
Ø mm: 133
12 Volt
PV 8



851774N

Sanden
SD7H13
Ø mm: 146
24 Volt
PV 1



851777N

Sanden
SD7H15
Ø mm: 120
12 Volt
PV 8
Zylinderkopf: JD
Ohrbefestigung



851785N

Sanden
SD7H15
Ø mm: 112
12 Volt
PV 4
Zylinderkopf: WV
Kurzbelegung



851786N

Kompressoren

Sanden
SD7H15
Ø mm: 140
24 Volt
PV 7
Zylinderkopf: SB
Kurzbefestigung



851822N

Sanden
SD7H15
Ø mm: 112
12 Volt
PV 6



851890N

Sanden
SD7H15
Ø mm: 180
12 Volt
PV 8
Zylinderkopf: WV
Kurzbefestigung



851892N

Sanden
SD7H15
Ø mm: 125
12 Volt
PV 6



851990N

Seiko -Seiki
Ø mm: 120
12 Volt
PV 4



851999N

Sanden
SD7H13
Ø mm: 120
12 Volt
PV 8



852003N

Sanden
SD5H14
Ø mm: 125
12 Volt
PV 10



852004N

Seltec
TM08
Ø mm: 136
24 Volt
PV 3



852012N

Sanden
SD5H14
Ø mm: 152
12 Volt
PV 2

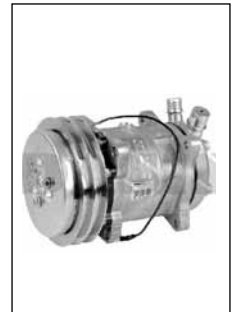

852022N

Denso
10PA15C lang

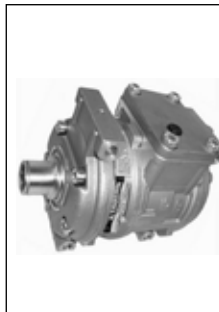

852028N

Sanden
SD5H11
Ø mm: 125
12 Volt
PV 2



852029N

Denso
10PA17C lang



852036N

Kompressoren

Denso
10PA17C kurz



852037N

Sanden
SD7H15
Ø mm: 13
12 Volt
PV 2
Zylinderkopf: UK
Ohrbefestigung



852078N

Sanden
SD7H15
Ø mm: 125
12 Volt
PV 6
Zylinderkopf: JE
Ohrbefestigung



852079N

Sanden
SD7H15
Ø mm: 125
12 Volt
PV 2
Zylinderkopf: GV
Kurzbefestigung



852081N

Sanden
SD7H15
Ø mm: 119
12 Volt
PV 8
Zylinderkopf: GV
Kurzbefestigung



852082N

Sanden
SD7H15
Ø mm: 125
12 Volt
PV 6
Zylinderkopf: GSA
Kurzbefestigung



852083N

Sanden
SD7H15
Ø mm: 125
12 Volt
PV 6
Zylinderkopf: GQ
Kurzbefestigung



852084N

Sanden
SD7H15
Ø mm: 119
12 Volt
PV 8
Zylinderkopf: GQ
Kurzbefestigung



852085N

Sanden
SD7H15
Ø mm: 125
12 Volt
PV 2
Zylinderkopf: JD
Ohrbefestigung



852086N

Sanden
SD7H15
Ø mm: 120
12 Volt
PV 6
Zylinderkopf: MD
Kurzbefestigung



852087N

Sanden
SD7H15
Ø mm: 119
12 Volt
PV 8
Zylinderkopf: KCA
Kurzbefestigung



852089N

Sanden
SD7H15
Ø mm: 125
12 Volt
PV 2
Zylinderkopf: GQ
Ohrbefestigung



852091N

Kompressoren

Sanden
SD7H15
Ø mm: 119
12 Volt
PV 8
Zylinderkopf: GQ
Ohrbefestigung



852092N

Sanden
SD7H15
Ø mm: 132
12 Volt
PV 2
Zylinderkopf: WV
Ohrbefestigung



852093N

Sanden
SD7H15
Ø mm: 119
24 Volt
PV 8
Zylinderkopf: JD
Ohrbefestigung



852094N

Sanden
SD7H15
Ø mm: 130
12 Volt
PV 7
Zylinderkopf: GF
Kurzbefestigung



852095N

Sanden
SD7H15
Ø mm: 125
12 Volt
PV 6
Zylinderkopf: GWA
Kurzbefestigung



852096N

Sanden
SD7H15
Ø mm: 119
12 Volt
PV 8
Zylinderkopf: GH
Kurzbefestigung



852097N

Sanden
SD7H15
Ø mm: 125
12 Volt
PV 2
Zylinderkopf: GV
Ohrbefestigung



852098N

Sanden
SD508
Ø mm: 152
12 Volt
PV 1
Zylinderkopf: C
Ohrbefestigung



852099N

Sanden
SD7H15
Ø mm: 125
12 Volt
PV 6
Zylinderkopf: GH
Kurzbefestigung



852101N

Sanden
SD7H15
Ø mm: 133
12 Volt
PV 8
Zylinderkopf: WV
Kurzbefestigung



852102N

Sanden
SD7H15
Ø mm: 123
12 Volt
PV 7
Zylinderkopf: OD
Ohrbefestigung



852103N

Sanden
SD7H15
Ø mm: 125
24 Volt
PV 2
Zylinderkopf: GV
Ohrbefestigung



852104N

Kompressoren

Sanden
SD7H15
Ø mm: 158
12 Volt
PV 1
Zylinderkopf: GV
Ohrbefestigung



852105N

Sanden
SD7H15
Ø mm: 158
24 Volt
PV 1
Zylinderkopf: GV
Ohrbefestigung



852106N

Sanden
SD7H15
Ø mm: 125
12 Volt
PV 10
Zylinderkopf: GV
Ohrbefestigung



852107N

Sanden
SD7H15
Ø mm: 153
12 Volt
PV 8
Zylinderkopf: GV
Ohrbefestigung



852108N

Sanden
SD7H15
Ø mm: 153
24 Volt
PV 1
Zylinderkopf: GV
Ohrbefestigung



852109N

Sanden
SD7H15
Ø mm: 152
24 Volt
PV 2
Zylinderkopf: GV
Ohrbefestigung



852110N

Sanden
SD7810
Ø mm: 112
12 Volt
PV 6
Zylinderkopf: P8
Ohrbefestigung



852111N

Sanden
SD7H15
Ø mm: 119
24 Volt
PV 8
Zylinderkopf: GV
Ohrbefestigung



852112N

Sanden
SD7H15
Ø mm: 132
12 Volt
PV 2
Zylinderkopf: JE
Ohrbefestigung



852115N

Sanden
SD7H15
Ø mm: 119
12 Volt
PV 6
Zylinderkopf: KG
Ohrbefestigung



852116N

Sanden
SD7H15
Ø mm: 119
12 Volt
PV 8
Zylinderkopf: JE
Ohrbefestigung



852117N

Sanden
SD7H15
Ø mm: 132
24 Volt
PV 2
Zylinderkopf: JE
Ohrbefestigung



852118N

Kompressoren

Sanden
SD508
Ø mm: 132
24 Volt
PV 2
Zylinderkopf: C
Ohrbefestigung

Bild folgt

852119N

Sanden
SD7H15
Ø mm: 130
12 Volt
PV 8
Zylinderkopf: WV
Ohrbefestigung



852121N

Sanden
SD7H15
Ø mm: 132
24 Volt
PV 2
Ohrbefestigung



852122N

Sanden
SD7H15
Ø mm: 132
12 Volt
PV 2
Zylinderkopf: PJE
Kurzbefestigung



852123N

Sanden
SD7H15
Ø mm: 125
12 Volt
PV 2
Ohrbefestigung

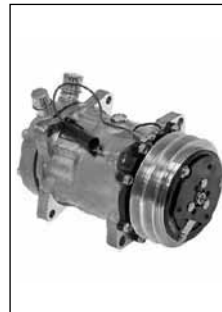

852124N

Sanden
SD7H15
Ø mm: 125
12 Volt
PV 6
Kurzbefestigung



852125N

Sanden
SD7H15
Ø mm: 119
12 Volt
PV 8
Zylinderkopf: MJA
Kurzbefestigung



852126N

Sanden
SD7H15
Ø mm: 119
12 Volt
PV 8
Zylinderkopf: GWA
Kurzbefestigung



852127N

Sanden
SD7H15
Ø mm: 132
24 Volt
PV 2
Zylinderkopf: JD
Ohrbefestigung



852128N

Sanden
SD7H15
Ø mm: 125
12 Volt
PV 6
Zylinderkopf: MD
Kurzbefestigung



852129N

Sanden
SD7H15
Ø mm: 125
12 Volt
PV 6
Zylinderkopf: JD
Kurzbefestigung



852131N

Sanden
SD7H15
Ø mm: 130
12 Volt
PV 8
Zylinderkopf: WV
Kurzbefestigung



852132N

Kompressoren

Sanden
SD508
Ø mm: 132
24 Volt
PV 2
Zylinderkopf: B
Ohrbefestigung



852133N

Sanden
SD508
Ø mm: 152
24 Volt
PV 2
Zylinderkopf: B
Ohrbefestigung



852134N

Sanden
SD507
Ø mm: 125
12 Volt
PV 2
Zylinderkopf: E
Ohrbefestigung



852135N

Sanden
SD507
Ø mm: 125
24 Volt
PV 2
Zylinderkopf: E
Ohrbefestigung



852136N

Sanden
SD7H15
Ø mm: 132
12 Volt
PV 2
Zylinderkopf: KCA
Kurzbefestigung



852138N

Sanden
SD7H15
Ø mm: 176
24 Volt
PV 8
Zylinderkopf: WV
Kurzbefestigung



852139N

Sanden
SD7H15
Ø mm: 153
12 Volt
PV 8
Zylinderkopf: JE
Ohrbefestigung



852141N

Sanden
SD7H15
Ø mm: 119
12 Volt
PV 8
Spezialbefestigung



852142N

Sanden
SD7H15
Ø mm: 132
12 Volt
PV 2
Zylinderkopf: JD
Kurzbefestigung



852143N

Sanden
SD7H15
Ø mm: 126
12 Volt
PV 12
Zylinderkopf: GQ
Kurzbefestigung



852144N

Sanden
SD7H15
Ø mm: 152
12 Volt
PV 2
Zylinderkopf: GV
Ohrbefestigung



852145N

Sanden
SD7H15
Ø mm: 132
12 Volt
PV 2
Zylinderkopf: MD
Ohrbefestigung



852146N

Kompressoren

Sanden
SD508
Ø mm: 152
12 Volt
PV 2
Zylinderkopf: N
Ohrbefestigung



852147N

Sanden
SD7H15
Ø mm: 119
12 Volt
PV 8
Kurzbefestigung



852148N

Sanden
SD7H15
Ø mm: 119
12 Volt
PV 8
Kurzbefestigung



852149N

Sanden
SD7H15
Ø mm: 125
12 Volt
PV 6
Zylinderkopf: GH
Kurzbefestigung



852151N

Sanden
SD7H15
Ø mm: 125
12 Volt
PV 6
Zylinderkopf: GSA
Kurzbefestigung

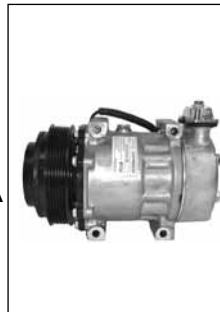

852152N

Sanden
SD7H15
Ø mm: 125
12 Volt
PV 6
Zylinderkopf: GQ
Kurzbefestigung



852153N

Sanden
SD7H15
Ø mm: 119
12 Volt
PV 8
Zylinderkopf: JE
Kurzbefestigung
Ohrbefestigung



852154N

Sanden
SD7H15
Ø mm: 119
12 Volt
PV 8
Zylinderkopf: GQ
Kurzbefestigung



852155N

Sanden
SD7H15
Ø mm: 119
12 Volt
PV 8
Zylinderkopf: GSA
Ohrbefestigung



852156N

Sanden
SD7H15
Ø mm: 119
12 Volt
PV 8
Zylinderkopf: MDA
Ohrbefestigung



852157N

Sanden
SD7H15
Ø mm: 132
12 Volt
PV 2
Zylinderkopf: MJA
Ohrbefestigung



852158N

Sanden
SD7H15
Ø mm: 125
12 Volt
PV 2
Zylinderkopf: OB
Ohrbefestigung



852159N

Kompressoren

Sanden
SD7H15
Ø mm: 119
12 Volt
PV 8
Zylinderkopf: WH
Kurzbefestigung



852161N

Sanden
SD7H15
Ø mm: 119
12 Volt
PV 8
Zylinderkopf: WJ
Ohrbefestigung



852162N

Sanden
SD7H15
Ø mm: 132
12 Volt
PV 2
Zylinderkopf: WJ
Ohrbefestigung



852163N

Sanden
SD7H15
Ø mm: 125
12 Volt
PV 6
Zylinderkopf: CB
Kurzbefestigung



852164N

Sanden
SD7H15
Ø mm: 125
12 Volt
PV 10
Zylinderkopf: JE
Ohrbefestigung



852165N

Sanden
SD5H09
Ø mm: 132
12 Volt
PV 2
Zylinderkopf: K
Ohrbefestigung



852166N

Sanden
SD5H14
Ø mm: 119
12 Volt
PV 7
Zylinderkopf: M
Ohrbefestigung



852167N

Sanden
SD7H15
Ø mm: 119
12 Volt
PV 8
Zylinderkopf: JD
Ohrbefestigung



852168N

Sanden
SD7H15
Ø mm: 119
12 Volt
PV 8
Zylinderkopf: WH
Kurzbefestigung



852169N

Sanden
SD7H15
Ø mm: 125
12 Volt
PV 6
Zylinderkopf: WJ
Kurzbefestigung



852171N

Sanden
SD7H15
Ø mm: 132
12 Volt
PV 2
Zylinderkopf: GH
Ohrbefestigung



852172N

Sanden
SD7H15
Ø mm: 125
12 Volt
PV 6
Zylinderkopf: CBA
Kurzbefestigung

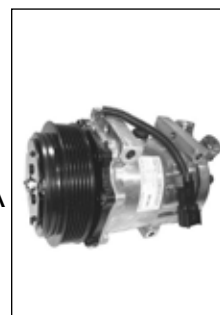

852173N

Kompressoren

Sanden
SD7H15
Ø mm: 132
12 Volt
PV 2
Zylinderkopf: JDA
Ohrbefestigung



852174N

Sanden
SD7H15
Ø mm: 132
12 Volt
PV 2
Zylinderkopf: SJA
Ohrbefestigung



852175N

Sanden
SD7H15
Ø mm: 119
12 Volt
PV 8
Zylinderkopf: KG
Ohrbefestigung



852176N

Sanden
SD7H15
Ø mm: 132
12 Volt
PV 2
Zylinderkopf: JD
Kurzbefestigung



852177N

Sanden
SD7H15
Ø mm: 119
12 Volt
PV 8
Zylinderkopf: GH
Ohrbefestigung



852178N

Sanden
SD7H15
Ø mm: 125
12 Volt
PV 10
Zylinderkopf: GV
Kurzbefestigung



852179N

Sanden
SD7H15
Ø mm: 119
12 Volt
PV 8
Zylinderkopf: KCA
Kurzbefestigung



852180N

Sanden
SD508
Ø mm: 132
12 Volt
PV 2
Zylinderkopf: C
Ohrbefestigung



852181N

Sanden
SD508
Ø mm: 119
12 Volt
PV 7
Zylinderkopf: EG
Ohrbefestigung



852182N

Sanden
SD7H15
Ø mm:
12 Volt
PV 6
Zylinderkopf: QC
Ohrbefestigung



852184N

Sanden
SD7H15
Ø mm: 132
24 Volt
PV 2
Zylinderkopf: MD
Ohrbefestigung



852185N

Sanden
SD7H15
Ø mm: 119
12 Volt
PV 8
Zylinderkopf: MJ
Ohrbefestigung



852186N

Kompressoren

Sanden
SD7H15
Ø mm: 125
12 Volt
PV 6
Zylinderkopf: UK
Ohrbefestigung



852187N

Sanden
SD7H15
Ø mm:
12 Volt
PV 2
Zylinderkopf: WV
Ohrbefestigung

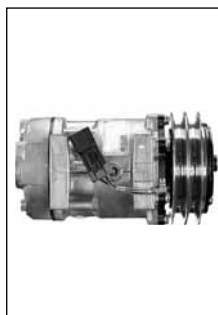

852188N

Sanden
SD7H15
Ø mm: 119
12 Volt
PV 8
Zylinderkopf: MJA
Kurzbelegung

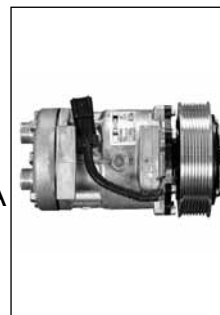

852189N

Sanden
SD7H15
Ø mm: 113
12 Volt
PV 6
Spezialbefestigung



852192N

Sanden
SD7H15
Ø mm: 144
12 Volt
PV 2



852210N

Seltec
TM15
Ø mm: 119
12 Volt
PV 6



852294N

Seltec
TM21
Ø mm: 141
12 Volt
PV 10



852295N

Seltec
TM15
Ø mm: 135
12 Volt
PV 2



852296N

Seltec
TM15
Ø mm: 125
12 Volt
PV 2



852298N

Seltec
TM15
Ø mm: 125
12 Volt
PV 2



852299N

Seltec
TM15
Ø mm: 119
12 Volt
PV 8



852300N

Seltec
TM15
Ø mm: 125
12 Volt
PV 2



852301N

Kompressoren

Seltec
TM15
Ø mm: 135
24 Volt
PV 2

Bild folgt

852302N

Seltec
TM15
Ø mm: 119
12 Volt
PV 8



852303N

Seltec
TM16
Ø mm: 135
12 Volt
PV 2



852304N

Seltec
TM16
Ø mm: 119
12 Volt
PV 6

Bild folgt

852305N

Seltec
TM16
Ø mm: 135
12 Volt
PV 2



852306N

Seltec
TM16
Ø mm: 135
12 Volt
PV 2



852307N

Seltec
TM16
Ø mm: 152
12 Volt
PV 2

Bild folgt

852308N

Seltec
TM16
Ø mm: 125
12 Volt
PV 2



852309N

Seltec
TM16
Ø mm: 119
12 Volt
PV 8



852310N

Seltec
TM16
Ø mm: 119
12 Volt
PV 8



852311N

Seltec
TM16
Ø mm: 119
12 Volt
PV 8

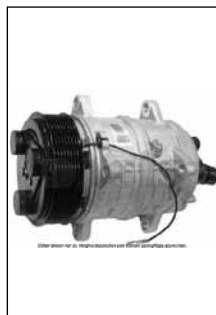

852312N

Seltec
TM16
Ø mm: 135
12 Volt
PV 2



852313N

Kompressoren

Seltec
TM16
Ø mm: 119
12 Volt
PV 6

Bild folgt

852314N

Seltec
TM16
Ø mm: 125
12 Volt
PV 2



852315N

Seltec
TM16
Ø mm: 126
12 Volt
PV 1



852316N

Seltec
TM16
Ø mm: 119
12 Volt
PV 8



852317N

Seltec
TM16
Ø mm: 119
12 Volt
PV 8



852318N

Seltec
TM16
Ø mm: 119
12 Volt
PV 8



852319N

Seltec
TM16
Ø mm: 135
12 Volt
PV 2



852321N

Seltec
TM16
Ø mm: 135
12 Volt
PV 2



852322N

Seltec
TM16
Ø mm: 119
12 Volt
PV 10



852323N

Seltec
TM21
Ø mm: 145
12 Volt
PV 2



852324N

Seltec
TM21
Ø mm: 137
12 Volt
PV 8



852325N

Seltec
TM21
Ø mm: 137
24 Volt
PV 8



852326N

Kompressoren

Seltec
TM21
Ø mm: 127
12 Volt
PV 8



852327N

Seltec
TM21
Ø mm: 137
12 Volt
PV 6



852328N

Seltec
TM21
Ø mm: 127
12 Volt
PV 10



Bild folgt

852329N

Seltec
TM31



852331N

Seltec
TM31
Ø mm: 152
12 Volt
PV 2



852332N

Seltec
TM31
Ø mm: 155
12 Volt
PV 2



852333N

Seltec
TM31
Ø mm: 158
24 Volt
PV 2



852334N

Seltec
TM31
Ø mm: 152
24 Volt
PV 1



Bild folgt

852338N

Sanden
SD7H13
Ø mm: 146
24 Volt
PV 1



852400N

Sanden
SD7H15
Ø mm: 125
12 Volt
PV 6



852650N

Sanden
SD7B10
Ø mm: 114
12 Volt
PV 6



853240N

Sanden
SD7H13
Ø mm: 125
12 Volt
PV 2



853310N

Kompressoren

Sanden
SD7H15
Ø mm: 120
12 Volt
PV 7



853330N

Sanden
SD7H15
Ø mm: 132
12 Volt
PV 2



853430N

Sanden
SD7H15
Ø mm: 140
12 Volt
PV 5



853570N

Sanden
SD7H15
Ø mm: 110
12 Volt
PV 1



853820N

Sanden
SD7H15
Ø mm: 125
12 Volt
PV 6



854070N

Sanden
SD7H15
Ø mm: 125
12 Volt
PV 6



854080N

Sanden
SD7H15
Ø mm: 125
12 Volt
PV 6



854090N

Sanden
SD7H15HD
Ø mm: 132
12 Volt
PV 2
Zylinderkopf: JD
Ohrbefestigung



858020N

Seltec
TM16
Ø mm: 136
24 Volt
PV 2
Anschluss oben



858260N

Sanden
SD7H15
Ø mm: 132
24 Volt
PV 2
Zylinderkopf: MD
Ohrbefestigung



858270N

Sanden
SD7H15
Ø mm: 136
24 Volt
PV 8



Bild folgt

858280N

Seiko-Seiki
SS121DS3
Ø mm: 132
12 Volt
PV 2



858387N

Kompressoren

Sanden
SD510
Ø mm: 132
12 Volt
PV 2
Zylinderkopf: M
Ohrbefestigung



858454N

Sanden
SD5H14
Ø mm: 132
12 Volt
PV 2
Zylinderkopf: B
Ohrbefestigung



858485N

Magnetkupplungen



Hersteller	Modell	Spannung (V)	Ø mm	Riemen-scheibe	Zylinderkopf ID	Dasis-Nr.
Denso	10PA	12 Volt	114	PV 5		852489N
Denso	10PA	12 Volt	115	PV 4		852499N
Denso	10PA	12 Volt	115	PV 5		852505N
Denso	10PA	12 Volt	115	PV 6		852491N
Denso	10PA	12 Volt	119	PV 6		852516N
Denso	10PA	12 Volt	124	PV 8		852518N
Denso	10PA	12 Volt	124	PV 8		852533N
Denso	10PA	12 Volt	125	PV 4		851460N
Denso	10PA	12 Volt	125	PV 4		852498N
Denso	10PA	12 Volt	125	PV 4		852512N
Denso	10PA	12 Volt	125	PV 6		852495N
Denso	10PA	12 Volt	125	PV 8		852513N
Denso	10PA	12 Volt	126	PV 4		851462N
Denso	10PA	12 Volt	127	PV 4		850213N
Denso	10PA	12 Volt	130	PV 6		852514N
Denso	10PA	12 Volt	133	1 AG		852502N
Denso	10PA	12 Volt	133	1 AG		852511N
Denso	10PA	12 Volt	133	1 AG		850536N
Denso	10PA	12 Volt	134	PV 6		850180N
Denso	10PA	12 Volt	135	2 AG		852517N
Denso	10PA	12 Volt	135	PV 5		852492N
Denso	10PA	12 Volt	135	PV 6		852504N

Magnetkupplungen

Hersteller	Modell	Spannung (V)	Ø mm	Riemen-scheibe	Zylinderkopf ID	Dasis-Nr.
Denso	10PA	12 Volt	135	PV 6		852515N
Denso	10PA	12 Volt	136	PV 7		850210N
Denso	10PA	12 Volt	137	1 AG		852490N
Denso	10PA	12 Volt	139	PV 4		850223N
Denso	10PA	12 Volt	139	PV 5		852494N
Denso	10PA	12 Volt	142	1 AG		852493N
Denso	10PA	12 Volt	143	1 AG		850220N
Denso	10PA	12 Volt	143	1 AG		852503N
Denso	10PA	12 Volt	143	1 AG		852507N
Denso	10PA	12 Volt	145	PV 8		852523N
Denso	10PA	12 Volt	145	PV 8		852524N
Denso	10PA	12 Volt	146	1 AG		852521N
Denso	10PA	12 Volt	146	1 AG		852528N
Denso	10PA	12 Volt	146	1 AG		852531N
Denso	10PA	12 Volt	146	PV 4		852501N
Denso	10PA	12 Volt	146	PV 6		852509N
Denso	10PA	12 Volt	147	PV 5		852506N
Denso	10PA	12 Volt	152	1 AG		852526N
Denso	10PA	12 Volt	167	PV 5		852497N
Denso	10PA	12 Volt	167	PV 6		852496N
Denso	10PA	24 Volt	124	PV 8		852519N
Denso	10PA	24 Volt	124	PV 8		852534N
Denso	10PA	24 Volt	145	PV 8		852525N
Denso	10PA	24 Volt	146	1 AG		852522N
Denso	10PA	24 Volt	146	1 AG		852529N
Denso	10PA	24 Volt	146	1 AG		852532N
Denso	10PA	24 Volt	152	1 AG		852527N
Denso	10PA15C	24 Volt	135	PV 9	FG	852191N
Harrison		12 Volt	125	PV		850016N
Harrison		12 Volt	125	PV		850017N
Sanden	SD507	12 Volt	125	2 AG	E	852278N
Sanden	SD507	24 Volt	125	2 AG	E	852279N
Sanden	SD508	12 Volt	119	PV 7	EG	852289N
Sanden	SD508	12 Volt	132	2 AG	C	852288N
Sanden	SD508	12 Volt	152	1 AG	C	852207N
Sanden	SD508	24 Volt	132	1 AG	FV	852282N
Sanden	SD508	24 Volt	152	2 AG	B	852196N
Sanden	SD510	12 Volt	125	PV 6	UB	852272N
Sanden	SD510	12 Volt	134	2 AG	N	852283N

Magnetkupplungen

Hersteller	Modell	Spannung (V)	Ø mm	Riemen-scheibe	Zylinderkopf ID	Dasis-Nr.
Sanden	SD508, SD510	12 Volt	152	2 AG	Q	852195N
Sanden	SD5H09	12 Volt	120	PV 5	EL	852271N
Sanden	SD5H09	12 Volt	125	2 AG	M	852273N
Sanden	SD5H09	24 Volt	125	2 AG	K	852274N
Sanden	SD505, SD5H09	24 Volt	125	2 AG	E	852281N
Sanden	SD5H14	12 Volt	119	PV 7	K	852268N
Sanden	SD5H14	12 Volt	119	PV 7	M	852286N
Sanden	SD508, SD510, SD5H14	12 Volt	132	2 AG	QH	852193N
Sanden	SD508, SD510, SD5H14	24 Volt	132	2 AG	M	852194N
Sanden	SD7810	12 Volt	112	PV 6	P8	852276N
Sanden	SD7B10	12 Volt	115	2 AG	PB	852275N
Sanden	SD7H13	12 Volt	125	2 AG	JE	852277N
Sanden	SD7H15	12 Volt	113	PV 6		852291N
Sanden	SD7H15	12 Volt	116	PV 4	WV	852212N
Sanden	SD7H15	12 Volt	119	PV 6	GN	852241N
Sanden	SD7H15	12 Volt	119	PV 6	JE	852236N
Sanden	SD7H15	12 Volt	119	PV 6	KG	852235N
Sanden	SD7H15	12 Volt	119	PV 6	QC	852242N
Sanden	SD7H15	12 Volt	119	PV 8	GH	852292N
Sanden	SD7H15	12 Volt	119	PV 8	GSA	852270N
Sanden	SD7H15	12 Volt	119	PV 8	JE	852248N
Sanden	SD7H15	12 Volt	119	PV 8	KCA	852256N
Sanden	SD7H15	12 Volt	119	PV 8	KG	852246N
Sanden	SD7H15	12 Volt	119	PV 8	MD	852244N
Sanden	SD7H15	12 Volt	119	PV 8	WH	852198N
Sanden	SD7H15	12 Volt	119	PV 8	WJ	852208N
Sanden	SD7H15	12 Volt	119	PV 8		852287N
Sanden	SD7H15	12 Volt	120	PV 6	MD	852237N
Sanden	SD7H15	12 Volt	123	PV 7	OD	852243N
Sanden	SD7H15	12 Volt	125	2 AG	GV	852221N
Sanden	SD7H15	12 Volt	125	2 AG	GV	852223N
Sanden	SD7H15	12 Volt	125	2 AG	QC	852199N
Sanden	SD7H15	12 Volt	125	2 AG	SJA	852219N
Sanden	SD7H15	12 Volt	125	PV 6	GSA	852269N

Magnetkupplungen

Hersteller	Modell	Spannung (V)	Ø mm	Riemen-scheibe	Zylinderkopf ID	Dasis-Nr.
Sanden	SD7H15	12 Volt	125	PV 6	JE	852197N
Sanden	SD7H15	12 Volt	125	PV 6	WJ	852238N
Sanden	SD7H15	12 Volt	125	1 AG	JE	852261N
Sanden	SD7H15	12 Volt	126	1 AG	GQ	852267N
Sanden	SD7H15	12 Volt	130	PV 6		852239N
Sanden	SD7H15	12 Volt	130	PV 7	GF	852262N
Sanden	SD7H15	12 Volt	130	PV 8	WV	852254N
Sanden	SD7H15	12 Volt	132	1 AG	QS	852284N
Sanden	SD7H15	12 Volt	132	2 AG	GB	852293N
Sanden	SD7H15	12 Volt	132	2 AG	MJ	852201N
Sanden	SD7H15	12 Volt	132	2 AG	WV	852226N
Sanden	SD7H15	12 Volt	133	PV 8	KC	852203N
Sanden	SD7H15	12 Volt	140	2 AG	QC	852232N
Sanden	SD7H15	12 Volt	150	2 AG	KG	852285N
Sanden	SD7H15	12 Volt	152	2 AG	GV	852204N
Sanden	SD7H15	12 Volt	152	2 AG	MD	852229N
Sanden	SD7H15	12 Volt	153	1 AG	GK	852215N
Sanden	SD7H15	12 Volt	153	1 AG	KC	852213N
Sanden	SD7H15	12 Volt	153	PV 8	GV	852263N
Sanden	SD7H15	12 Volt	153	PV 8	JE	852257N
Sanden	SD7H15	12 Volt	153	PV 8	KCA	852259N
Sanden	SD7H15	12 Volt	153	PV 8	MD	852209N
Sanden	SD7H15	12 Volt	158	1 AG	GV	852233N
Sanden	SD7H15	12 Volt	180	PV 8	WV	852265N
Sanden	SD7H15	24 Volt	119	PV 8	JD	852245N
Sanden	SD7H15	24 Volt	119	PV 8	KG	852247N
Sanden	SD7H15	24 Volt	119	PV 8	MD	852249N
Sanden	SD7H15	24 Volt	125	2 AG	JD	852222N
Sanden	SD7H15	24 Volt	132	2 AG	JE	852224N
Sanden	SD7H15	24 Volt	132	2 AG	JE	852225N
Sanden	SD7H15	24 Volt	132	2 AG	JE	852227N
Sanden	SD7H15	24 Volt	132	2 AG	MD	852202N
Sanden	SD7H15	24 Volt	132	2 AG	WV	852228N
Sanden	SD7H15	24 Volt	132	PV 8	KF	852251N
Sanden	SD7H15	24 Volt	132	PV 8	WV	852252N
Sanden	SD7H15	24 Volt	132	PV 8		852253N
Sanden	SD7H15	24 Volt	135	1 AG	MD	852218N
Sanden	SD7H15	24 Volt	152	2 AG	GV	852206N
Sanden	SD7H15	24 Volt	152	2 AG	MD	852231N

Magnetkupplungen

Hersteller	Modell	Spannung (V)	Ø mm	Riemenscheibe	Zylinderkopf ID	Dasis-Nr.
Sanden	SD7H15	24 Volt	153	1 AG	GK	852214N
Sanden	SD7H15	24 Volt	153	1 AG	GK	852217N
Sanden	SD7H15	24 Volt	153	1 AG	GV	852216N
Sanden	SD7H15	24 Volt	153	PV 8	GK	852255N
Sanden	SD7H15	24 Volt	153	PV 8	GK	852258N
Sanden	SD7H15	24 Volt	158	1 AG	GV	852234N
Sanden	SD7H15	24 Volt	176	PV 8	WV	852266N
Seiko-Seiki	SS121, SS170	12 Volt	120	PV 6		850391N
Seiko-Seiki	SS121, SS170	12 Volt	120	PV 8		850389N
Seiko-Seiki	SSMS	12 Volt	120	1 AG		850388N
Seltec	TM15	12 Volt	119	PV 6		852358N
Seltec	TM15	24 Volt	135	2 AG		852344N
Seltec	TM16	12 Volt	119	PV 6		852343N
Seltec	TM16	12 Volt	119	PV 8		852339N
Seltec	TM16	12 Volt	119	1 AG0		852357N
Seltec	TM16	12 Volt	126	1 AG		852352N
Seltec	TM16	12 Volt	152	2 AG		852353N
Seltec	TM15, TM16	12 Volt	119	PV 6		852342N
Seltec	TM15, TM16	12 Volt	119	PV 8		852341N
Seltec	TM15, TM16	12 Volt	125	2 AG		852355N
Seltec	TM15, TM16	12 Volt	135	2 AG		852345N
Seltec	TM21	12 Volt	127	PV 8		852351N
Seltec	TM21	12 Volt	127	1 AG		852356N
Seltec	TM21	12 Volt	137	PV 6		852354N
Seltec	TM21	12 Volt	137	PV 8		852346N
Seltec	TM21	12 Volt	141	1 AG		852349N
Seltec	TM21	12 Volt	145	2 AG		852348N
Seltec	TM21	24 Volt	137	PV 8		852347N
Seltec	TM31	12 Volt	152	1 AG		852364N
Seltec	TM31	12 Volt	152	2 AG		852365N
Seltec	TM31	12 Volt	155	2 AG		852363N
Seltec	TM31	12 Volt	156	PV 8		852361N
Seltec	TM31	24 Volt	152	1 AG		852366N
Seltec	TM31	24 Volt	152	2 AG		852367N
Seltec	TM31	24 Volt	156	PV 8		852362N
Seltec	TM31	24 Volt	158	2 AG		852359N
Visteon	FS10, FX15	12 Volt	117	PV 6		850405N

Magnetkupplungen

Hersteller	Modell	Spannung (V)	Ø mm	Riemenscheibe	Zylinderkopf ID	Dasis-Nr.
Visteon	FS10, FX15	12 Volt	130	PV 5		850406N
Visteon	FS10, FX15	12 Volt	130	PV 6		850404N
Visteon	FS10, FX15	12 Volt	133	PV 8		850407N
York	206, 209, 210	12 Volt	177	2 AG		850383N
York	206, 209, 210	24 Volt	152	2 AG		850384N
York	Mini-Compact	12 Volt	125	2 AG		850385N

Magnetkupplungen

<p>Harrison</p> <p>Ø mm: 125 12 Volt PV</p> <p>Bild folgt</p> <p>850016N</p>	<p>Harrison</p> <p>Ø mm: 125 12 Volt PV</p> <p>Bild folgt</p> <p>850017N</p>	<p>Denso 10PA Ø mm: 134 12 Volt PV 6</p>  <p>850180N</p>
<p>Denso 10PA Ø mm: 136 12 Volt PV 7</p>  <p>850210N</p>	<p>Denso 10PA Ø mm: 127 12 Volt PV 4</p>  <p>850213N</p>	<p>Denso 10PA Ø mm: 143 12 Volt PV 1</p>  <p>850220N</p>
<p>Denso 10PA Ø mm: 139 12 Volt PV 4</p>  <p>850223N</p>	<p>York 206: 209: 210 Ø mm: 177 12 Volt PV 2</p>  <p>850383N</p>	<p>York 206: 209: 210 Ø mm: 152 24 Volt PV 2</p>  <p>850384N</p>
<p>York Mini-Compact Ø mm: 125 12 Volt PV 2</p>  <p>850385N</p>	<p>Seiko-Seiki SSMS Ø mm: 120 12 Volt PV 1</p>  <p>850388N</p>	<p>Seiko-Seiki SS121: SS170 Ø mm: 120 12 Volt PV 8</p>  <p><small>Bitte diesen nur in Drehmomenten und U/minen einhängen!</small></p> <p>850389N</p>

Magnetkupplungen

Seiko-Seiki
SS121: SS170
Ø mm: 120
12 Volt
PV 6



850391N

Visteon
FX15: FS10
Ø mm: 130
12 Volt
PV 6



850404N

Visteon
FX15: FS10
Ø mm: 117
12 Volt
PV 6



850405N

Visteon
FS10: FX15
Ø mm: 130
12 Volt
PV 5



850406N

Visteon
FX15: FS10
Ø mm: 133
12 Volt
PV 8



850407N

Denso
10PA
Ø mm: 133
12 Volt
PV 1



850536N

Denso
10PA
Ø mm: 125
12 Volt
PV 4



851460N

Denso
10PA
Ø mm: 126
12 Volt
PV 4



851462N

Denso
10PA15C
Ø mm: 135
24 Volt
PV 9
Zylinderkopf: FG



852191N

Sanden
SD508: SD510:
SD5H14
Ø mm: 132
12 Volt
PV 2
Zylinderkopf: QH



852193N

Sanden
SD508: SD510:
SD5H14
Ø mm: 132
24 Volt
PV 2
Zylinderkopf: M



852194N

Sanden
SD508: SD510
Ø mm: 152
12 Volt
PV 2
Zylinderkopf: Q



852195N

Magnetkupplungen

Sanden
SD508
Ø mm: 152
24 Volt
PV 2
Zylinderkopf: B



852196N

Sanden
SD7H15
Ø mm: 125
12 Volt
PV 6
Zylinderkopf: JE



852197N

Sanden
SD7H15
Ø mm: 119
12 Volt
PV 8
Zylinderkopf: WH



852198N

Sanden
SD7H15
Ø mm: 125
12 Volt
PV 2
Zylinderkopf: QC



852199N

Sanden
SD7H15
Ø mm: 132
12 Volt
PV 2
Zylinderkopf: MJ



852201N

Sanden
SD7H15
Ø mm: 132
24 Volt
PV 2
Zylinderkopf: MD



852202N

Sanden
SD7H15
Ø mm: 133
12 Volt
PV 8
Zylinderkopf: KC



852203N

Sanden
SD7H15
Ø mm: 152
12 Volt
PV 2
Zylinderkopf: GV



852204N

Sanden
SD7H15
Ø mm: 152
24 Volt
PV 2
Zylinderkopf: GV



852206N

Sanden
SD508
Ø mm: 152
12 Volt
PV 1
Zylinderkopf: C



852207N

Sanden
SD7H15
Ø mm: 119
12 Volt
PV 8
Zylinderkopf: WJ



852208N

Sanden
SD7H15
Ø mm: 153
12 Volt
PV 8
Zylinderkopf: MD

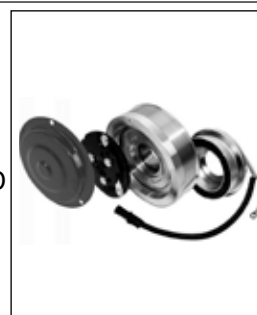

852209N

Magnetkupplungen

Sanden
SD7H15
Ø mm: 116
12 Volt
PV 4
Zylinderkopf: WV



852212N

Sanden
SD7H15
Ø mm: 153
12 Volt
PV 1
Zylinderkopf: KC



852213N

Sanden
SD7H15
Ø mm: 153
24 Volt
PV 1
Zylinderkopf: GK



852214N

Sanden
SD7H15
Ø mm: 153
12 Volt
PV 1
Zylinderkopf: GK



852215N

Sanden
SD7H15
Ø mm: 153
24 Volt
PV 1
Zylinderkopf: GV



852216N

Sanden
SD7H15
Ø mm: 153
24 Volt
PV 1
Zylinderkopf: GK



852217N

Sanden
SD7H15
Ø mm: 135
24 Volt
PV 1
Zylinderkopf: MD



852218N

Sanden
SD7H15
Ø mm: 125
12 Volt
PV 2
Zylinderkopf: SJA



852219N

Sanden
SD7H15
Ø mm: 125
12 Volt
PV 2
Zylinderkopf: GV



852221N

Sanden
SD7H15
Ø mm: 125
24 Volt
PV 2
Zylinderkopf: JD



852222N

Sanden
SD7H15
Ø mm: 125
12 Volt
PV 2
Zylinderkopf: GV



852223N

Sanden
SD7H15
Ø mm: 132
24 Volt
PV 2
Zylinderkopf: JE

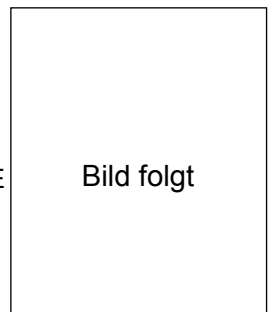

852224N

Magnetkupplungen

Sanden
SD7H15
Ø mm: 132
24 Volt
PV 2
Zylinderkopf: JE

Bild folgt

852225N

Sanden
SD7H15
Ø mm: 132
12 Volt
PV 2
Zylinderkopf: WV



852226N

Sanden
SD7H15
Ø mm: 132
24 Volt
PV 2
Zylinderkopf: JE



852227N

Sanden
SD7H15
Ø mm: 132
24 Volt
PV 2
Zylinderkopf: WV



852228N

Sanden
SD7H15
Ø mm: 152
12 Volt
PV 2
Zylinderkopf: MD



852229N

Sanden
SD7H15
Ø mm: 152
24 Volt
PV 2
Zylinderkopf: MD



852231N

Sanden
SD7H15
Ø mm: 140
12 Volt
PV 2
Zylinderkopf: QC



852232N

Sanden
SD7H15
Ø mm: 158
12 Volt
PV 1
Zylinderkopf: GV



852233N

Sanden
SD7H15
Ø mm: 158
24 Volt
PV 1
Zylinderkopf: GV



852234N

Sanden
SD7H15
Ø mm: 119
12 Volt
PV 6
Zylinderkopf: KG



852235N

Sanden
SD7H15
Ø mm: 119
12 Volt
PV 6
Zylinderkopf: JE

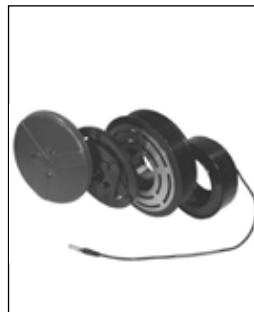

852236N

Sanden
SD7H15
Ø mm: 120
12 Volt
PV 6
Zylinderkopf: MD



852237N

Magnetkupplungen

Sanden
SD7H15
Ø mm: 125
12 Volt
PV 6
Zylinderkopf: WJ



852238N

Sanden
SD7H15
Ø mm: 130
12 Volt
PV 6



852239N

Sanden
SD7H15
Ø mm: 119
12 Volt
PV 6
Zylinderkopf: GN



852241N

Sanden
SD7H15
Ø mm: 119
12 Volt
PV 6
Zylinderkopf: QC



852242N

Sanden
SD7H15
Ø mm: 123
12 Volt
PV 7
Zylinderkopf: OD



852243N

Sanden
SD7H15
Ø mm: 119
12 Volt
PV 8
Zylinderkopf: MD



852244N

Sanden
SD7H15
Ø mm: 119
24 Volt
PV 8
Zylinderkopf: JD



852245N

Sanden
SD7H15
Ø mm: 119
12 Volt
PV 8
Zylinderkopf: KG



852246N

Sanden
SD7H15
Ø mm: 119
24 Volt
PV 8
Zylinderkopf: KG



852247N

Sanden
SD7H15
Ø mm: 119
12 Volt
PV 8
Zylinderkopf: JE



852248N

Sanden
SD7H15
Ø mm: 119
24 Volt
PV 8
Zylinderkopf: MD



852249N

Sanden
SD7H15
Ø mm: 132
24 Volt
PV 8
Zylinderkopf: KF



852251N

Magnetkupplungen

Sanden
SD7H15
Ø mm: 132
24 Volt
PV 8
Zylinderkopf: WV



852252N

Sanden
SD7H15
Ø mm: 132
24 Volt
PV 8



852253N

Sanden
SD7H15
Ø mm: 130
12 Volt
PV 8
Zylinderkopf: WV



852254N

Sanden
SD7H15
Ø mm: 153
24 Volt
PV 8
Zylinderkopf: GK



852255N

Sanden
SD7H15
Ø mm: 119
12 Volt
PV 8
Zylinderkopf: KCA



852256N

Sanden
SD7H15
Ø mm: 153
12 Volt
PV 8
Zylinderkopf: JE



852257N

Sanden
SD7H15
Ø mm: 153
24 Volt
PV 8
Zylinderkopf: GK



852258N

Sanden
SD7H15
Ø mm: 153
12 Volt
PV 8
Zylinderkopf: KCA



852259N

Sanden
SD7H15
Ø mm: 125
12 Volt
PV 10
Zylinderkopf: JE



852261N

Sanden
SD7H15
Ø mm: 130
12 Volt
PV 7
Zylinderkopf: GF



852262N

Sanden
SD7H15
Ø mm: 153
12 Volt
PV 8
Zylinderkopf: GV



852263N

Sanden
SD7H15
Ø mm: 180
12 Volt
PV 8
Zylinderkopf: WV



852265N

Magnetkupplungen

Sanden
SD7H15
Ø mm: 176
24 Volt
PV 8
Zylinderkopf: WV



852266N

Sanden
SD7H15
Ø mm: 126
12 Volt
PV 12
Zylinderkopf: GQ



852267N

Sanden
SD5H14
Ø mm: 119
12 Volt
PV 7
Zylinderkopf: K



852268N

Sanden
SD7H15
Ø mm: 125
12 Volt
PV 6
Zylinderkopf: GSA



852269N

Sanden
SD7H15
Ø mm: 119
12 Volt
PV 8
Zylinderkopf: GSA



852270N

Sanden
SD5H09
Ø mm: 120
12 Volt
PV 5
Zylinderkopf: EL



852271N

Sanden
SD510
Ø mm: 125
12 Volt
PV 6
Zylinderkopf: UB



852272N

Sanden
SD5H09
Ø mm: 125
12 Volt
PV 2
Zylinderkopf: M



852273N

Sanden
SD5H09
Ø mm: 125
24 Volt
PV 2
Zylinderkopf: K

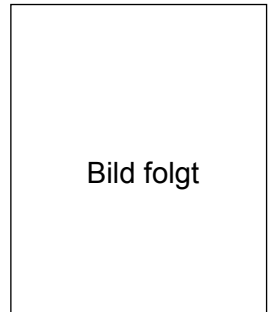

852274N

Sanden
SD7B10
Ø mm: 115
12 Volt
PV 2
Zylinderkopf: PB



852275N

Sanden
SD7810
Ø mm: 112
12 Volt
PV 6
Zylinderkopf: P8



852276N

Sanden
SD7H13
Ø mm: 125
12 Volt
PV 2
Zylinderkopf: JE



852277N

Magnetkupplungen

Sanden
SD507
Ø mm: 125
12 Volt
PV 2
Zylinderkopf: E



852278N

Sanden
SD507
Ø mm: 125
24 Volt
PV 2
Zylinderkopf: E



852279N

Sanden
SD505, SD5H09
Ø mm: 125
24 Volt
PV 2
Zylinderkopf: E



852281N

Sanden
SD508
Ø mm: 132
24 Volt
PV 1
Zylinderkopf: FV



852282N

Sanden
SD510
Ø mm: 134
12 Volt
PV 2
Zylinderkopf: N



852283N

Sanden
SD7H15
Ø mm: 132
12 Volt
PV 1
Zylinderkopf: QS



852284N

Sanden
SD7H15
Ø mm: 150
12 Volt
PV 2
Zylinderkopf: KG



852285N

Sanden
SD5H14
Ø mm: 119
12 Volt
PV 7
Zylinderkopf: M



852286N

Sanden
SD7H15
Ø mm: 119
12 Volt
PV 8



852287N

Sanden
SD508
Ø mm: 132
12 Volt
PV 2
Zylinderkopf: C



852288N

Sanden
SD508
Ø mm: 119
12 Volt
PV 7
Zylinderkopf: EG



852289N

Sanden
SD7H15
Ø mm: 113
12 Volt
PV 6



852291N

Magnetkupplungen

Sanden
SD7H15
Ø mm: 119
12 Volt
PV 8
Zylinderkopf: GH



852292N

Sanden
SD7H15
Ø mm: 132
12 Volt
PV 2
Zylinderkopf: GB



852293N

Seltec
TM16
Ø mm: 119
12 Volt
PV 8



852339N

Seltec
TM15: TM16
Ø mm: 119
12 Volt
PV 8



852341N

Seltec
TM15: TM16
Ø mm: 119
12 Volt
PV 6



852342N

Seltec
TM16
Ø mm: 119
12 Volt
PV 6



852343N

Seltec
TM15
Ø mm: 135
24 Volt
PV 2



852344N

Seltec
TM15: TM16
Ø mm: 135
12 Volt
PV 2



852345N

Seltec
TM21
Ø mm: 137
12 Volt
PV 8



852346N

Seltec
TM21
Ø mm: 137
24 Volt
PV 8



852347N

Seltec
TM21
Ø mm: 145
12 Volt
PV 2



852348N

Seltec
TM21
Ø mm: 141
12 Volt
PV 10



852349N

Magnetkupplungen

Seltec
TM21
Ø mm: 127
12 Volt
PV 8



852351N

Seltec
TM16
Ø mm: 126
12 Volt
PV 1



852352N

Seltec
TM16
Ø mm: 152
12 Volt
PV 2



852353N

Seltec
TM21
Ø mm: 137
12 Volt
PV 6



852354N

Seltec
TM15: TM16
Ø mm: 125
12 Volt
PV 2



852355N

Seltec
TM21
Ø mm: 127
12 Volt
PV 10



852356N

Seltec
TM16
Ø mm: 119
12 Volt
PV 10



852357N

Seltec
TM15
Ø mm: 119
12 Volt
PV 6



852358N

Seltec
TM31
Ø mm: 158
24 Volt
PV 2



852359N

Seltec
TM31
Ø mm: 156
12 Volt
PV 8



852361N

Seltec
TM31
Ø mm: 156
24 Volt
PV 8



852362N

Seltec
TM31
Ø mm: 155
12 Volt
PV 2



852363N

Magnetkupplungen

Seltec
TM31
Ø mm: 152
12 Volt
PV 1



852364N

Seltec
TM31
Ø mm: 152
12 Volt
PV 2



852365N

Seltec
TM31
Ø mm: 152
24 Volt
PV 1



852366N

Seltec
TM31
Ø mm: 152
24 Volt
PV 2



852367N

Denso
10PA
Ø mm: 114
12 Volt
PV 5



852489N

Denso
10PA
Ø mm: 137
12 Volt
PV 1



852490N

Denso
10PA
Ø mm: 115
12 Volt
PV 6



852491N

Denso
10PA
Ø mm: 135
12 Volt
PV 5



852492N

Denso
10PA
Ø mm: 142
12 Volt
PV 1



852493N

Denso
10PA
Ø mm: 139
12 Volt
PV 5



852494N

Denso
10PA
Ø mm: 125
12 Volt
PV 6

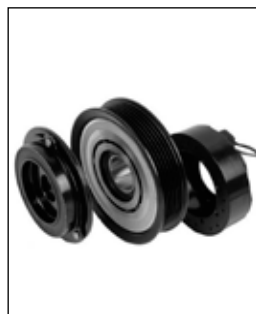

852495N

Denso
10PA
Ø mm: 167
12 Volt
PV 6



852496N

Magnetkupplungen

Denso
10PA
Ø mm: 167
12 Volt
PV 5



852497N

Denso
10PA
Ø mm: 125
12 Volt
PV 4



852498N

Denso
10PA
Ø mm: 115
12 Volt
PV 4



852499N

Denso
10PA
Ø mm: 146
12 Volt
PV 4

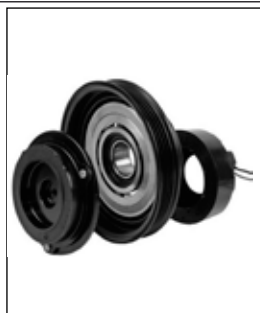

852501N

Denso
10PA
Ø mm: 133
12 Volt
PV 1



852502N

Denso
10PA
Ø mm: 143
12 Volt
PV 1



852503N

Denso
10PA
Ø mm: 135
12 Volt
PV 6



852504N

Denso
10PA
Ø mm: 115
12 Volt
PV 5

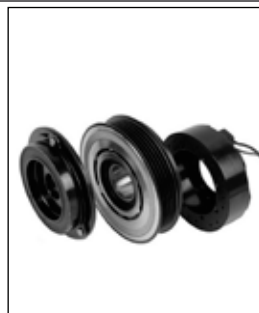

852505N

Denso
10PA
Ø mm: 147
12 Volt
PV 5



852506N

Denso
10PA
Ø mm: 143
12 Volt
PV 1



852507N

Denso
10PA
Ø mm: 146
12 Volt
PV 6



852509N

Denso
10PA
Ø mm: 133
12 Volt
PV 1



852511N

Magnetkupplungen

Denso
10PA
Ø mm: 125
12 Volt
PV 4



852512N

Denso
10PA
Ø mm: 125
12 Volt
PV 8



852513N

Denso
10PA
Ø mm: 130
12 Volt
PV 6



852514N

Denso
10PA
Ø mm: 135
12 Volt
PV 6



852515N

Denso
10PA
Ø mm: 119
12 Volt
PV 6



852516N

Denso
10PA
Ø mm: 135
12 Volt
PV 2



852517N

Denso
10PA
Ø mm: 124
12 Volt
PV 8



852518N

Denso
10PA
Ø mm: 124
24 Volt
PV 8



852519N

Denso
10PA
Ø mm: 146
12 Volt
PV 1



852521N

Denso
10PA
Ø mm: 146
24 Volt
PV 1



852522N

Denso
10PA
Ø mm: 145
12 Volt
PV 8



852523N

Denso
10PA
Ø mm: 145
12 Volt
PV 8
Staubschutzkappe



852524N

Magnetkupplungen

Denso
10PA
Ø mm: 145
24 Volt
PV 8



852525N

Denso
10PA
Ø mm: 152
12 Volt
PV 1



852526N

Denso
10PA
Ø mm: 152
24 Volt
PV 1



852527N

Denso
10PA
Ø mm: 146
12 Volt
PV 1



852528N

Denso
10PA
Ø mm: 146
24 Volt
PV 1



852529N

Denso
10PA
Ø mm: 146
12 Volt
PV 1



852531N

Denso
10PA
Ø mm: 146
24 Volt
PV 1



852532N

Denso
10PA
Ø mm: 124
12 Volt
PV 8



852533N

Denso
10PA
24 Volt
Ø mm: 124
PV 8



852534N

Kompressordichtungen

Chrysler
2C1



908147N

Chrysler
C171



908152N

Denso
171

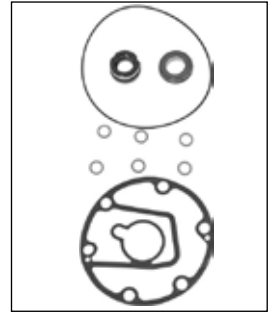

900159N

Denso
6C17



900147N

Denso
6P127

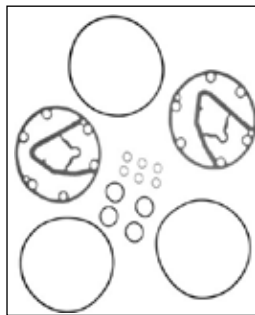

900126N

Denso
6P134

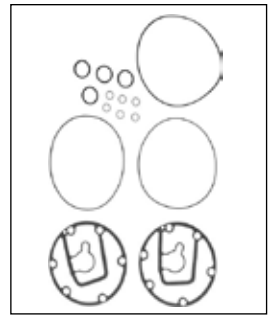

900127N

Denso
10P13/
10P15

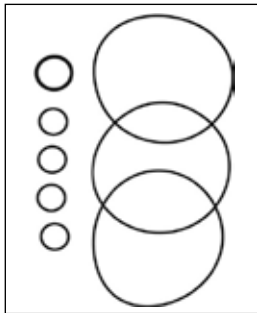

900125N

Denso
10P13/
10P13C/
10P15

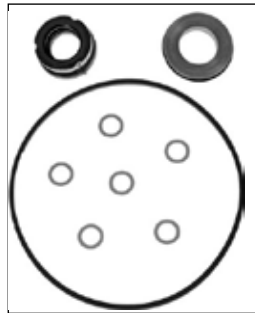

908141N

Denso
10P17

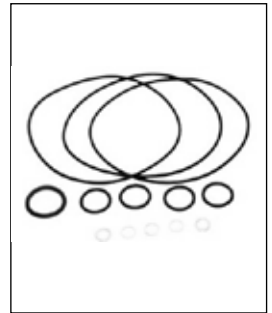

900132N

Denso
10P17



900167N

Denso
10PA15C

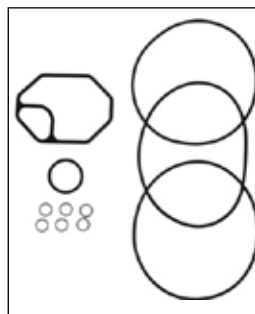

900138N

Denso
10PA15C

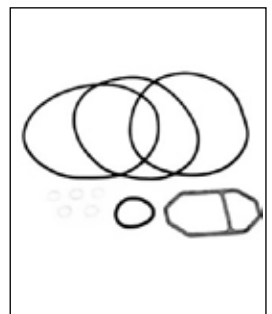

900139N

Kompressordichtungen

Denso
10PA17

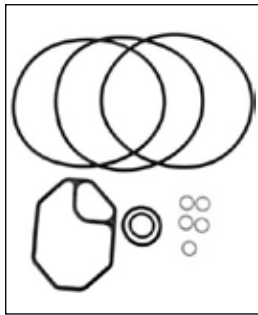

900129N

Denso
10PA17C

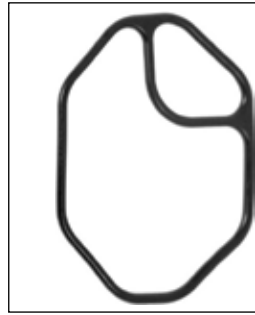

908155N

Denso
10PA17C



900163N

Denso
10PA20C

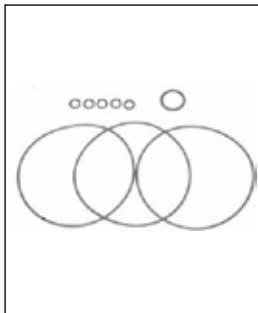

900142N

Harrison
A6

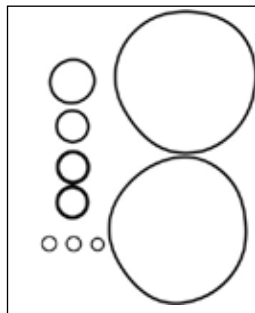

907970N

Harrison
A6



900158N

Harrison
HR6

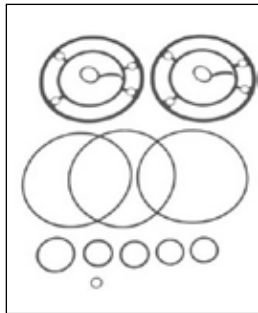

908138N

Harrison
HR6

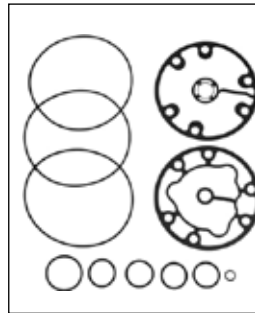

900135N

Harrison
R4

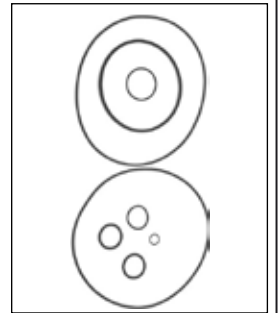

900121N

Harrison
R4
Grün

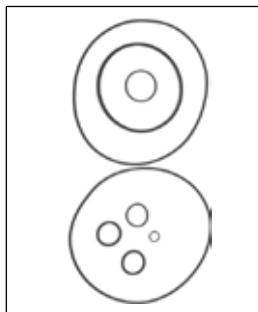

900122N

Harrison
R4



901221N

Harrison
V5

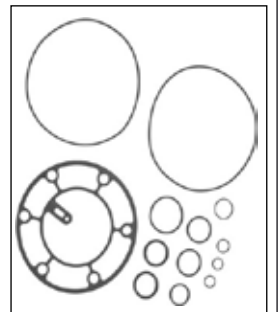

900123N

Kompressordichtungen

Harrison
V5

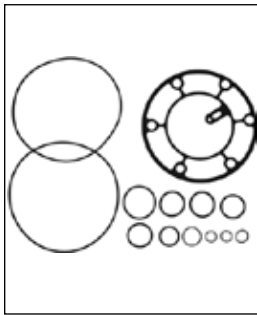

900136N

Harrison
V5



900151N

Harrison
V5

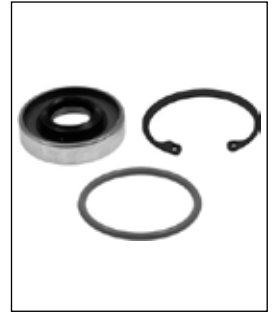

900164N

Sanden
7H15



900168N

Sanden
7V16



900162N

Sanden
SD5

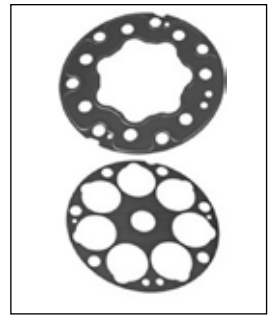

900118N

Sanden
SD505/SD507

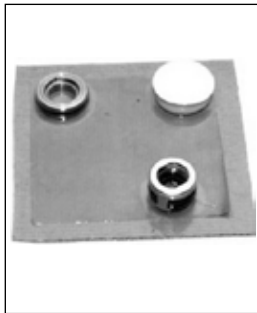

900154N

Sanden
SD508/SD510



900153N

Sanden
SD5H

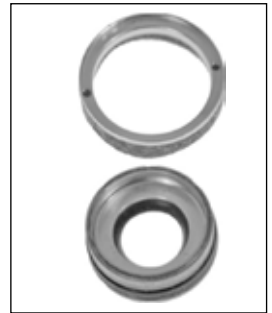

900156N

Sanden
SD708/SD709



900155N

Sanden
SD7B10

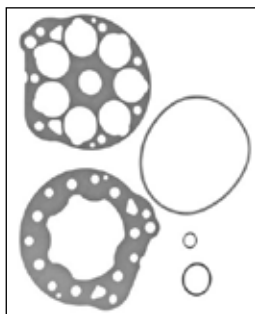

900128N

Sanden
SD7H

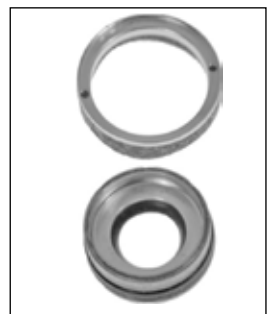

900156N

Kompressordichtungen

Sanden
SD7H15

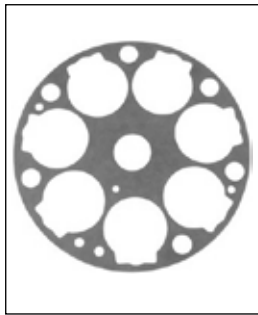

900143N

Sanden
SD7V16

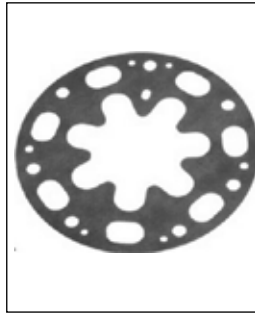

900145N

Sanden
SD7V16

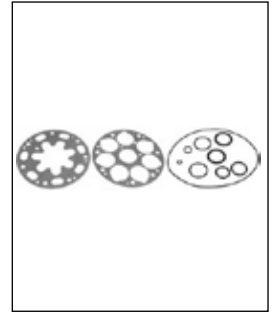

900146N

Sanden
TR90

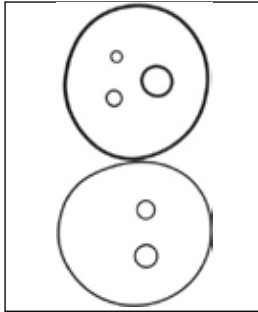

900144N

Seiko Seiki
SS170



900166N

Seltec
TM08/TM16



900119N

Seltec
TM08-21



900157N

Seltec
TM31

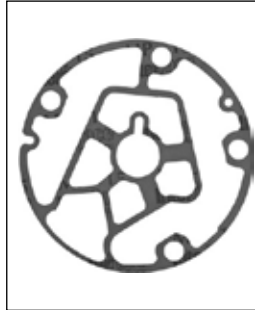

900148N

Tecumseh
HG850/HG1000

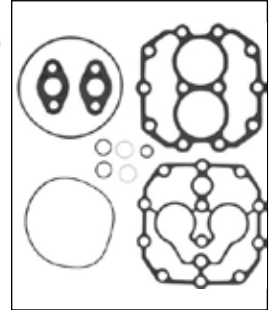

908139N

Visteon
FS10

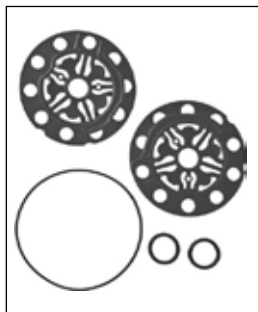

900134N

Visteon
FS10



900161N

York
206

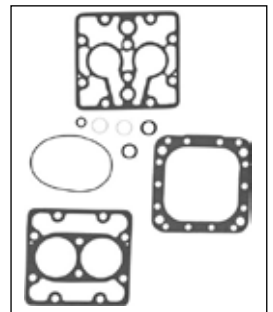

900124N

Kompressordichtungen

York
209

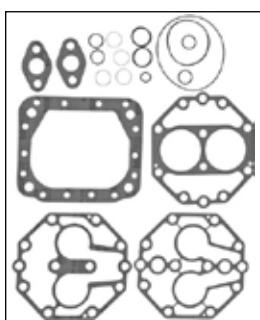

908140N

York
209/210



900152N

York

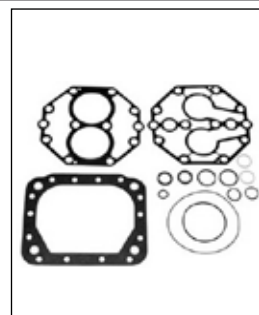

900133N

Zylinderköpfe

Hersteller	Modell	Zylinderkopf ID	Anschluss-technik	Gewinde 1	Gewinde 2	Anschluss	Dasis-Nr.
Sanden	SD505, SD507	E		3/4"	7/8"	V-Anschluss oben	850033N
Sanden	SD505, SD507, SD508, SD510	FG	O-Ring	3/4"	7/8"	V Anschluss oben	850044N
Sanden	SD508	FV					852073N
Sanden	SD508, SD510	B		3/4"	7/8"	V-Anschluss oben	850034N
Sanden	SD508, SD510	C					850035N
Sanden	SD508, SD510	N					852075N
Sanden	SD510	Q	O-Ring				850047N
Sanden	SD510	QH					852076N
Sanden	SD510	UB					852077N
Sanden	SD5H09	C					850035N
Sanden	SD5H09, SD5H14	FL					850051N
Sanden	SD5H09, SD5H14	K					852074N
Sanden	SD5H10	E		3/4"	7/8"	V-Anschluss oben	850033N
Sanden	SD5H11, SD7H15	CB					850037N
Sanden	SD7H08, SD7H09, SD7H13, SD7H15	JE	O-Ring			V Anschluss oben	850043N
Sanden	SD7H15	CBA				V Anschluss oben	852045N
Sanden	SD7H15	GF				seitlich	852062N
Sanden	SD7H15	GH		3/4"	7/8"		852048N
Sanden	SD7H15	GK	O-Ring			nach hinten	852063N
Sanden	SD7H15	GN				seitlich	852065N
Sanden	SD7H15	GQ				seitlich	852055N
Sanden	SD7H15	GSA				nach oben	852058N
Sanden	SD7H15	GV		3/4"	7/8"	nach hinten	852059N
Sanden	SD7H15	GWA				nach hinten	852064N
Sanden	SD7H15	JDA					852068N
Sanden	SD7H15	KC					850046N
Sanden	SD7H15	KCA		3/4"	7/8"		852049N
Sanden	SD7H15	KF					852047N
Sanden	SD7H15	KG		3/4"	7/8"		852051N

Zylinderköpfe

Hersteller	Modell	Zylinderkopf ID	Anschluss-technik	Gewinde 1	Gewinde 2	Anschluss	Dasis-Nr.
Sanden	SD7H15	MDA				nach hinten	850038N
Sanden	SD7H15	MJA					852052N
Sanden	SD7H15	QC				nach hinten	852053N
Sanden	SD7H15	QS					852069N
Sanden	SD7H15	UK		3/4"	7/8"	nach oben	852054N
Sanden	SD7H15	WH					852071N
Sanden	SD7H15	WJ					852072N
Sanden	SD7H15	WV		3/4"	7/8"		852046N
Sanden	SD7H15					seitlich	852061N
Sanden	SD7H15					seitlich	852066N
Sanden	SD7H15					seitlich	852067N
Seltec	TM15HD		O-Ring			nach oben	850053N
York	206, 209, 210		O-Ring				850054N
York	206, 209, 210		Flansch				850055N
York	206, 209, 210		Rotalock				850056N

Zylinderköpfe

Sanden
SD505, SD507,
SD5H10
Zylinderkopf: E
Gewinde 1: 3/4"
Gewinde 2: 7/8"



850033N

Sanden
SD508, SD510
Zylinderkopf: B
Gewinde 1: 3/4"
Gewinde 2: 7/8"



850034N

Sanden
SD508, SD510
Zylinderkopf: C



850035N

Sanden
SD5H09
Zylinderkopf: C



850035N

Sanden
SD5H11, SD7H15
Zylinderkopf: CB



850037N

Sanden
SD7H15
Zylinderkopf: MDA



850038N

Sanden
SD7H08, SD7H09,
SD7H13, SD7H15
Zylinderkopf: JE



850043N

Sanden
SD505, SD507,
SD508, SD510
Zylinderkopf: FG
Gewinde 1: 3/4"
Gewinde 2: 7/8"



850044N

Sanden
SD7H15
Zylinderkopf: KC



850046N

Sanden
SD510
Zylinderkopf: Q



850047N

Sanden
SD5H09, SD5H14
Zylinderkopf: FL



850051N

Seltec
TM15HD
O-Ring

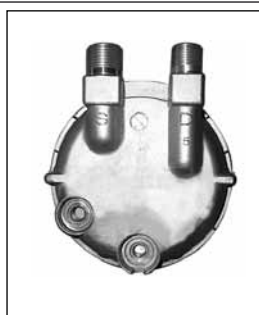

850053N

Zylinderköpfe

York
206, 209, 210



850054N

York
206, 209, 210



850055N

York
206, 209, 210
Rotalock



850056N

Sanden
SD7H15
Zylinderkopf: CBA



852045N

Sanden
SD7H15
Zylinderkopf: WV
Gewinde 1: 3/4"
Gewinde 2: 7/8"



852046N

Sanden
SD7H15
Zylinderkopf: KF



852047N

Sanden
SD7H15
Zylinderkopf: GH
Gewinde 1: 3/4"
Gewinde 2: 7/8"



852048N

Sanden
SD7H15
Zylinderkopf: KCA
Gewinde 1: 3/4"
Gewinde 2: 7/8"



852049N

Sanden
SD7H15
Zylinderkopf: KG
Gewinde 1: 3/4"
Gewinde 2: 7/8"



852051N

Sanden
SD7H15
Zylinderkopf: MJA



852052N

Sanden
SD7H15
Zylinderkopf: QC



852053N

Sanden
SD7H15
Zylinderkopf: UK
Gewinde 1: 3/4"
Gewinde 2: 7/8"

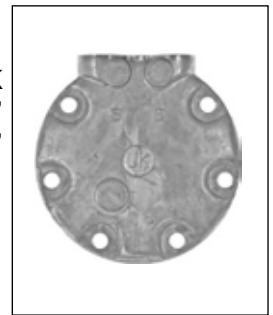

852054N

Zylinderköpfe

Sanden
SD7H15
Zylinderkopf: GQ



852055N

Sanden
SD7H15
Zylinderkopf: GSA



852058N

Sanden
SD7H15
Zylinderkopf: GV
Gewinde 1: 3/4"
Gewinde 2: 7/8"



852059N

Sanden
SD7H15

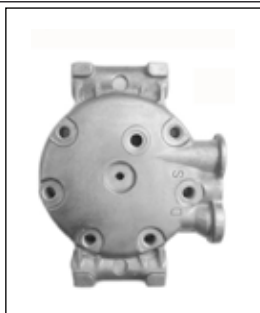

852061N

Sanden
SD7H15
Zylinderkopf: GF

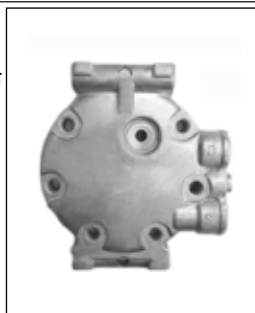

852062N

Sanden
SD7H15
Zylinderkopf: GK



852063N

Sanden
SD7H15
Zylinderkopf: GWA



852064N

Sanden
SD7H15
Zylinderkopf: GN



852065N

Sanden
SD7H15



852066N

Sanden
SD7H15



852067N

Sanden
SD7H15
Zylinderkopf: JDA



852068N

Sanden
SD7H15
Zylinderkopf: QS



852069N

Zylinderköpfe

Sanden
SD7H15
Zylinderkopf: WH



852071N

Sanden
SD7H15
Zylinderkopf: WJ



852072N

Sanden
SD508
Zylinderkopf: FV



852073N

Sanden
SD5H09, SD5H14
Zylinderkopf: K



852074N

Sanden
SD508, SD510
Zylinderkopf: N



852075N

Sanden
SD510
Zylinderkopf: QH

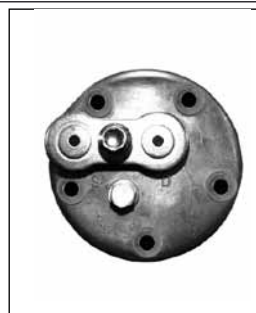

852076N

Sanden
SD510
Zylinderkopf: UB



852077N

Spulen



Hersteller	Modell	Spannung	Ø Innen mm	Ø Aussen mm	Tiefe mm	Info	Dasis-Nr.
Bock							909073N
Denso	10PA / 10S	12V				2 Kabel	852475N
Denso	10PA / 10S	12V				2 Kabel	852476N
Denso	10PA / 10S	12V				3 Kabel	852477N
Denso	10PA / 10S	12V				2 Kabel	852482N
Denso	10PA / 10S	12V				2 Kabel	852483N
Denso	10PA / 10S	12V				2 Kabel	852486N
Denso	10PA / 10S	24V				2 Kabel	852484N
Denso	10PA / 10S	24V				2 Kabel	852485N
Denso	10S	12V	40	96,4	25	Integral	852478N
Denso	10S	12V	40	96,4	25	2 Kabel	852479N
Denso	10S	24V	40	96,4	25	2 Kabel	852481N
Denso		12V				2 Kabel	852487N
Sanden	SD505 / SD5H09	12V					852382N
Sanden	SD507	12V					852384N
Sanden	SD507	24V					852385N
Sanden	SD508	24V					852381N
Sanden	SD508 / SD510	12V					852380N
Sanden	SD508 / SD510 / SD5H14	12V	38,5	72,5	50		852378N
Sanden	SD508 / SD510 / SD5H14	24V	38,5	72,5	50		852379N

Spulen

Hersteller	Modell	Spannung	Ø Innen mm	Ø Aussen mm	Tiefe mm	Info	Dasis-Nr.
Sanden	SD5H09	24V					852383N
Sanden	SD7B10	24V					852386N
Sanden	SD7H15	12V	45	103	27,5		852377N
Sanden	SD7H15	12V	45	96	32,5		852370N
Sanden	SD7H15	12V	45	96	32,5		852371N
Sanden	SD7H15	12V	45	96	32,5		852373N
Sanden	SD7H15	12V	45	96	32,5		852374N
Sanden	SD7H15	24V	45	96	32,5		852369N
Sanden	SD7H15	24V	45	96	32,5		852372N
Sanden	SD7H15	12V	62	93	23		852375N
Sanden	SD7H15	24V	62	93	23		852376N
Seltec	TM15 / TM16	12V	40	101	28		852387N
Seltec	TM15 / TM16	12V	40	101	28		852388N
Seltec	TM16	12V					852392N
Seltec	TM21	12V					852368N
Seltec	TM21	12V					852389N
Seltec	TM21	12V					852390N
Seltec	TM21	24V					852391N
Seltec	TM31	12V					852395N
Seltec	TM31	24V					852393N
Seltec	TM31	24V					852394N
Seltec	TM31	24V					852396N

Spulen

Seltec
TM21
12V

Bild folgt

852368N

Sanden
SD7H15
Ø ID mm: 45
Ø AD mm: 96
Tiefe mm: 32
24V
5



852369N

Sanden
SD7H15
Ø ID mm: 45
Ø AD mm: 96
Tiefe mm: 32
12V
5



852370N

Sanden
SD7H15
Ø ID mm: 45
Ø AD mm: 96
Tiefe mm: 32
12V
5



852371N

Sanden
SD7H15
Ø ID mm: 45
Ø AD mm: 96
Tiefe mm: 32
24V
5



852372N

Sanden
SD7H15
Ø ID mm: 45
Ø AD mm: 96
Tiefe mm: 32
12V
5



852373N

Sanden
SD7H15
Ø ID mm: 45
Ø AD mm: 96
Tiefe mm: 32
12V
5



852374N

Sanden
SD7H15
Ø ID mm: 62
Ø AD mm: 93
Tiefe mm: 23
12V



852375N

Sanden
SD7H15
Ø ID mm: 62
Ø AD mm: 93
Tiefe mm: 23
24V



852376N

Sanden
SD7H15
Ø ID mm: 45
Ø AD mm: 103
Tiefe mm: 27
12V
5



852377N

Sanden
SD508, SD510,
SD5H14
Ø ID mm: 38.5
Ø AD mm: 72.5
Tiefe mm: 50
12V



852378N

Sanden
SD508, SD510,
SD5H14
Ø ID mm: 38.5
Ø AD mm: 72.5
Tiefe mm: 50
24V



852379N

Spulen

Sanden
SD508, SD510
12V

Bild folgt

852380N

Sanden
SD508
24V

Bild folgt

852381N

Sanden
SD505, SD5H09
12V

Bild folgt

852382N

Sanden
SD5H09
24V

Bild folgt

852383N

Sanden
SD507
12V

Bild folgt

852384N

Sanden
SD507
24V



852385N

Sanden
SD7B10
24V

Bild folgt

852386N

Seltec
TM15, TM16
Ø ID mm: 40
Ø AD mm: 101
Tiefe mm: 28
12V



852387N

Seltec
TM15, TM16
Ø ID mm: 40
Ø AD mm: 101
Tiefe mm: 28
12V



852388N

Seltec
TM21
12V

Bild folgt

852389N

Seltec
TM21
12V

Bild folgt

852390N

Seltec
TM21
24V



852391N

Spulen

Seltec
TM16
12V

Bild folgt

852392N

Seltec
TM31
24V



852393N

Seltec
TM31
24V



852394N

Seltec
TM31
12V



852395N

Seltec
TM31
24V



852396N

Denso
10PA, 10S
12V
2 Kabel



852475N

Denso
10PA, 10S
12V
2 Kabel



852476N

Denso
10PA, 10S
12V
3 Kabel



852477N

Denso
10S
Ø ID mm: 40
Ø AD mm: 96.4
Tiefe mm: 25
12V
Integral



852478N

Denso
10S
Ø ID mm: 40
Ø AD mm: 96.4
Tiefe mm: 25
12V
2 Kabel



852479N

Denso
10S
Ø ID mm: 40
Ø AD mm: 96.4
Tiefe mm: 25
24V
2 Kabel



852481N

Denso
10PA, 10S
12V
2 Kabel



852482N

Spulen

Denso
10PA, 10S
12V
2 Kabel



852483N

Denso
10PA, 10S
24V
2 Kabel



852484N

Denso
10PA, 10S
24V
2 Kabel



852485N

Denso
10PA, 10S
12V
2 Kabel



852486N

Denso
12V
2 Kabel



852487N

Bock



909073N

Kupplungsnaabe

Harrison
A6
Ø AD mm: 117
Lang



858008N

Harrison
A6
Ø AD mm: 117
Kurz



858009N

Harrison
CVC
Ø AD mm: 105



858011N

Harrison
V5



858018N

Sanden
PXV16
Ø AD mm: 105



858006N

Sanden
SD6V12
Ø AD mm: 105



858005N

Sanden
SD7H15
Ø AD mm: 105



858007N

Sanden
SD7V16
Ø AD mm: 105



858000N

Sanden
SD7V16
Ø AD mm: 105



858001N

Sanden
SD7V16
Ø AD mm: 105



858002N

Sanden
TRS090
Ø AD mm: 105



858003N

Sanden
TRS090
Ø AD mm: 105



858004N

Kupplungsnaabe

Seltec / Zexel
DCS17E



858012N

Seltec / Zexel
TM08, TM13,
TM15, TM16



858013N

Seltec / Zexel
TM08, TM13,
TM15, TM16



858014N

Seltec / Zexel
TM16



858017N

Seltec / Zexel
TM21



858015N

Seltec / Zexel
TM21



858016N

Regelventile

Delphi
CVC
12V



859002N

Denso
5SEU12C,
5SE12C
12V



859003N

Denso
5SL12C
12V



859007N

Denso
6CA17A
12V



859009N

Denso
6SEU/
6SEU14C/
7SEU16C
12V



859005N

Denso
6SEU14C
12V



859004N

Denso
7SEU16C
12V



859008N

Sanden
PXE14
12V



859001N

Sanden
PXE14/
PXE16
12V
Late



859000N

Sanden
PXE16
12V
Early



859010N

Sanden
SD6C12/
SD7C16
12V



859006N

Zexel
DCS17E
12V



859011N

Expansionsventile

Einlass: 3/8"
Auslass: 1/2"
Sog EIN: 1/2"
Sog AUS: 5/8"



840320N

Einlass: 3/8"
Auslass: 1/2"
Sog EIN: 1/2"
Sog AUS: 5/8"



840070N

Einlass: 3/8"
Auslass: 1/2"
Sog EIN: 1/2"
Sog AUS: 5/8"
O-Ring



840120N

Einlass: 3/8"
Auslass: 1/2"
Sog EIN: 1/2"
Sog AUS: 5/8"
O-Ring



840130N

Einlass: 3/8"
Auslass: 1/2"
Sog EIN: 5/8"
Sog AUS: 3/4"
O-Ring



840157N

Einlass: 3/8"
Auslass: 1/2"
Sog EIN: 5/8"
Sog AUS: 3/4"
O-Ring



840163N

Einlass: 3/8"
Auslass: 1/2"
Sog EIN: 5/8"
Sog AUS: 3/4"
O-Ring



840520N

Einlass: 3/8"
Auslass: 1/2"
Sog EIN: 5/8"
Sog AUS: 3/4"



840090N

Einlass: 3/8"
Auslass: 1/2"
Sog EIN: 5/8"
Sog AUS: 3/4"
O-Ring



840310N

Einlass: 3/8"
Auslass: 1/2"
Sog EIN: 5/8"
Sog AUS: 5/8"
O-Ring



840086N

Einlass: 3/8"
Auslass: 1/2"
Sog EIN: 5/8"
Sog AUS: 5/8"
O-Ring



840290N

Einlass: 3/8"
Auslass: 1/2"
Sog EIN: 5/8"
Sog AUS: 5/8"



840021N

Expansionsventile

Einlass: 3/8"
Auslass: 3/4"
Sog EIN: 3/4"
Sog AUS: 3/4"



840800N

Einlass: 3/8"
Auslass: 5/8"
Sog EIN: 5/8"
Sog AUS: 5/8"
O-Ring



840660N

Einlass: 3/8"
Auslass: 5/8"
Sog EIN: 5/8"
Sog AUS: 5/8"
O-Ring



840037N

Einlass: 3/8"
Auslass: 5/8"
Sog EIN: 5/8"
Sog AUS: 5/8"
O-Ring



840166N

Einlass: 3/8"
Auslass: 1/2"
Typ: Coil
Kap.Länge mm: 203
Flansch
M



840060N

Einlass: 16mm
Auslass: 20mm
Typ: BULB
Kap.Länge mm: 203
O-Ring
M

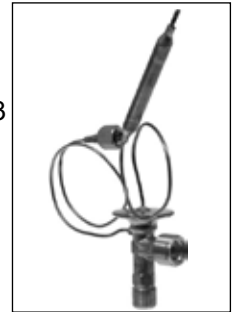

840550N

Einlass: 3/8"
Auslass: 1/2"
Typ: Coil
Kap.Länge mm: 230
O-Ring



840006N

Einlass: 3/8"
Auslass: 1/2"
Typ: Coil
Kap.Länge mm: 305
Flansch



840340N

Einlass: 3/8"
Auslass: 1/2"
Typ: Coil
Kap.Länge mm: 355
O-Ring



840490N

Einlass: 16mm
Auslass: 22mm
Typ: BULB
Kap.Länge mm: 406
O-Ring



840114N

Einlass: 3/8"
Auslass: 1/2"
Typ: Coil
Kap.Länge mm: 419
O-Ring
M

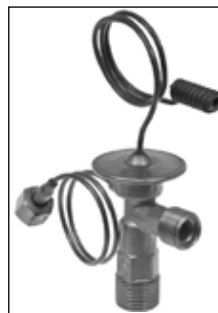

840100N

Einlass: 3/8"
Auslass: 1/2"
Typ: Coil
Kap.Länge mm: 480
Flansch



840050N

Expansionsventile

Einlass: 3/8"
Auslass: 1/2"
Typ: BULB
Kap.Länge mm: 838
O-Ring
M



841042N

Kondensator

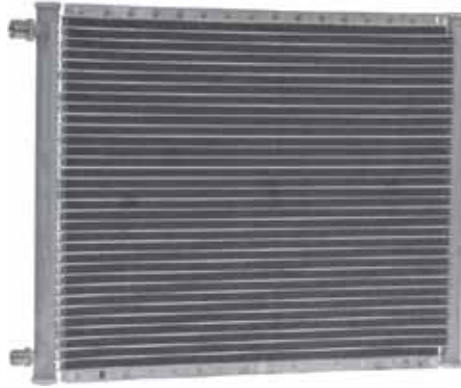

Typ	Gewinde	Fitting	Länge mm	Breite mm	Tiefe mm	Dasis-Nr.
Parallel Flow	M	3/8" O-Ring	457	356	22	542025N
Parallel Flow	M	3/8" O-Ring	462	406	18	542033N
Parallel Flow	M	3/8" O-Ring	508	305	22	542026N
Parallel Flow	M	3/8" O-Ring	552	356	22	542027N
Parallel Flow	M	3/8" O-Ring	610	305	22	542028N
Parallel Flow	M	3/8" O-Ring	610	356	22	542029N
Parallel Flow	M	3/8" O-Ring	648	356	22	542030N
Parallel Flow	M	3/8" O-Ring	660	305	18	542031N
Parallel Flow	M	3/8" O-Ring	711	406	18	542032N
Parallel Flow	M	3/8" O-Ring	902	400	22	540000N
Parallel Flow	M	3/8" O-Ring	950	600	22	540015N



Typ	Gewinde	Fitting	Länge mm	Breite mm	Tiefe mm	Dasis-Nr.
Serpentin Flow	M	3/8" O-Ring	457	249	22	542011N
Serpentin Flow	M	3/8" O-Ring	457	302	22	542012N
Serpentin Flow	M	3/8" O-Ring	457	354	22	542010N
Serpentin Flow	M	3/8" O-Ring	533	354	18	542016N
Serpentin Flow	M	3/8" O-Ring	584	302	22	542015N
Serpentin Flow	M	3/8" O-Ring	584	354	18	542014N
Serpentin Flow	M	3/8" O-Ring	660	302	22	542013N
Serpentin Flow	M	3/8" O-Ring	660	407	22	542017N
Serpentin Flow	M	3/8" O-Ring	660	459	22	542018N
Serpentin Flow	M	3/8" O-Ring	711	459	22	542019N

Innenraumgebläse

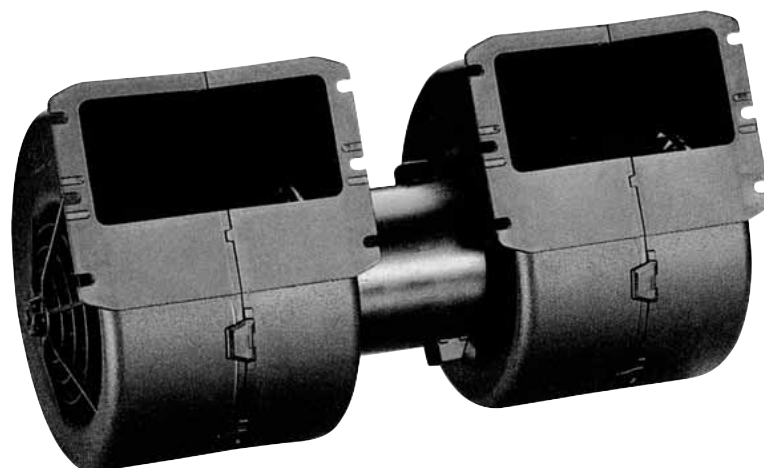

Einbaubreite mm	Einbauhöhe mm	Einbautiefe mm	Auslass mm	Spannung [V]	Spezifikation	Dasis-Nr.:
317	124,6	111,7	55x113,5	12V	Radial, 3 Stufen	879060N
317	124,6	111,7	60x135	12V	Radial, 3 Stufen	879000N
317	124,6	111,7	60x135	12V	Radial, 3 Stufen	879001N
320	127,5	113,1	45x 99	12V	Radial, 1 Stufe	879041N
320	127,5	113,1	45x 99	12V	Radial, 1 Stufe	879043N
320	127,5	113,1	45x 99	12V	Radial, 1 Stufe	879045N
320	127,5	113,1	45x 99	12V	Radial, 3 Stufen	879038N
320	127,5	113,1	45x 99	12V	Radial, 3 Stufen	879042N
320	127,5	113,1	45x 99	12V	Radial, 3 Stufen	879044N
351	168,5	139,8	60x 104	12V	Radial, 1 Stufe	879004N
351	168,5	139,8	60x 104	12V	Radial, 3 Stufen	879005N
351	168,5	139,8	60x 104	12V	Radial, 4 Stufen	879006N
351	168,5	139,8	60x104	12V	Radial, 1 Stufe	879010N
351	168,5	139,8	60x104	12V	Radial, 1 Stufe	879013N
351	168,5	139,8	60x104	12V	Radial, 1 Stufe	879016N
351	168,5	139,8	60x104	12V	Radial, 3 Stufen	879011N
351	168,5	139,8	60x104	12V	Radial, 3 Stufen	879014N
351	168,5	139,8	60x104	12V	Radial, 3 Stufen	879017N
351	168,5	139,8	60x104	12V	Radial, 4 Stufen	879012N
351	168,5	139,8	60x104	12V	Radial, 4 Stufen	879015N
351	168,5	139,8	60x104	12V	Radial, 4 Stufen	879018N
317	124,6	111,7	55x 113,5	24V	Radial, 3 Stufen	879058N
317	124,6	111,7	60 x 102,5	24V	Radial, 3 Stufen	879057N
317	124,6	111,7	60x135	24V	Radial, 3 Stufen	879002N
317	124,6	111,7	60x135	24V	Radial, 3 Stufen	879003N
320	127,5	113,1	45x 99	24V	Radial, 1 Stufe	879049N
320	127,5	113,1	45x 99	24V	Radial, 1 Stufe	879051N
320	127,5	113,1	45x 99	24V	Radial, 3 Stufen	879050N
320	127,5	113,1	45x 99	24V	Radial, 3 Stufen	879052N
335	163,9	146	55x115	24V	Radial, 1 Stufe	879053N
335	163,9	146	55x115	24V	Radial, 3 Stufen	879054N
335	163,9	146	55x115	24V	Radial, 4 Stufen	879055N

Innenraumgebläse

Einbaubreite mm	Einbauhöhe mm	Einbautiefe mm	Auslass mm	Spannung [V]	Spezifikation	Dasis-Nr.
335	163,9	146	55x115	24V	Radial, Drehzahlr.	879056N
351	168,5	139,8	60x104	24V	Radial, 1 Stufe	879025N
351	168,5	139,8	60x104	24V	Radial, 1 Stufe	879028N
351	168,5	139,8	60x104	24V	Radial, 1 Stufe	879031N
351	168,5	139,8	60x104	24V	Radial, 1 Stufe	879034N
351	168,5	139,8	60x104	24V	Radial, 3 Stufen	879026N
351	168,5	139,8	60x104	24V	Radial, 3 Stufen	879029N
351	168,5	139,8	60x104	24V	Radial, 3 Stufen	879032N
351	168,5	139,8	60x104	24V	Radial, 3 Stufen	879035N
351	168,5	139,8	60x104	24V	Radial, 4 Stufen	879027N
351	168,5	139,8	60x104	24V	Radial, 4 Stufen	879030N
351	168,5	139,8	60x104	24V	Radial, 4 Stufen	879033N
351	168,5	139,8	60x104	24V	Radial, 4 Stufen	879036N

Innenraumgebläse

Breite mm: 317
Höhe mm: 124,6
Tiefe mm: 111,7
12V
Radial, 3 Stufen



879000N

Breite mm: 317
Höhe mm: 124,6
Tiefe mm: 111,7
12V
Radial, 3 Stufen



879001N

Breite mm: 317
Höhe mm: 124,6
Tiefe mm: 111,7
24V
Radial, 3 Stufen



879002N

Breite mm: 317
Höhe mm: 124,6
Tiefe mm: 111,7
24V
Radial, 3 Stufen



879003N

Breite mm: 351
Höhe mm: 168,5
Tiefe mm: 139,8
12V
Radial, 1 Stufe



879004N

Breite mm: 351
Höhe mm: 168,5
Tiefe mm: 139,8
12V
Radial, 3 Stufen



879005N

Breite mm: 351
Höhe mm: 168,5
Tiefe mm: 139,8
12V
Radial, 4 Stufen



879006N

Breite mm: 351
Höhe mm: 168,5
Tiefe mm: 139,8
12V
Radial, 1 Stufe



879010N

Breite mm: 351
Höhe mm: 168,5
Tiefe mm: 139,8
12V
Radial, 3 Stufen



879011N

Breite mm: 351
Höhe mm: 168,5
Tiefe mm: 139,8
12V
Radial, 4 Stufen



879012N

Breite mm: 351
Höhe mm: 168,5
Tiefe mm: 139,8
12V
Radial, 1 Stufe



879013N

Breite mm: 351
Höhe mm: 168,5
Tiefe mm: 139,8
12V
Radial, 3 Stufen



879014N

Innenraumgebläse

Breite mm: 351
Höhe mm: 168,5
Tiefe mm: 139,8
12V
Radial, 4 Stufen



879015N

Breite mm: 351
Höhe mm: 168,5
Tiefe mm: 139,8
12V
Radial, 1 Stufe



879016N

Breite mm: 351
Höhe mm: 168,5
Tiefe mm: 139,8
12V
Radial, 3 Stufen



879017N

Breite mm: 351
Höhe mm: 168,5
Tiefe mm: 139,8
12V
Radial, 4 Stufen



879018N

Breite mm: 351
Höhe mm: 168,5
Tiefe mm: 139,8
24V
Radial, 1 Stufe



879025N

Breite mm: 351
Höhe mm: 168,5
Tiefe mm: 139,8
24V
Radial, 3 Stufen



879026N

Breite mm: 351
Höhe mm: 168,5
Tiefe mm: 139,8
24V
Radial, 4 Stufen



879027N

Breite mm: 351
Höhe mm: 168,5
Tiefe mm: 139,8
24V
Radial, 1 Stufe



879028N

Breite mm: 351
Höhe mm: 168,5
Tiefe mm: 139,8
24V
Radial, 3 Stufen



879029N

Breite mm: 351
Höhe mm: 168,5
Tiefe mm: 139,8
24V
Radial, 4 Stufen



879030N

Breite mm: 351
Höhe mm: 168,5
Tiefe mm: 139,8
24V
Radial, 1 Stufe



879031N

Breite mm: 351
Höhe mm: 168,5
Tiefe mm: 139,8
24V
Radial, 3 Stufen

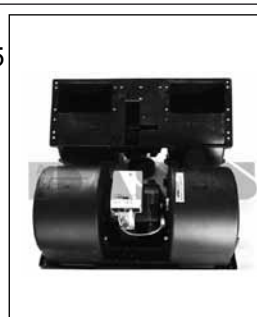

879032N

Innenraumgebläse

Breite mm: 351
Höhe mm: 168,5
Tiefe mm: 139,8
24V
Radial, 4 Stufen



879033N

Breite mm: 351
Höhe mm: 168,5
Tiefe mm: 139,8
24V
Radial, 1 Stufe



879034N

Breite mm: 351
Höhe mm: 168,5
Tiefe mm: 139,8
24V
Radial, 3 Stufen



879035N

Breite mm: 351
Höhe mm: 168,5
Tiefe mm: 139,8
24V
Radial, 4 Stufen



879036N

Breite mm: 320
Höhe mm: 127,5
Tiefe mm: 113,1
12V
Radial, 3 Stufen



879038N

Breite mm: 320
Höhe mm: 127,5
Tiefe mm: 113,1
12V
Radial, 1 Stufe



879041N

Breite mm: 320
Höhe mm: 127,5
Tiefe mm: 113,1
12V
Radial, 3 Stufen



879042N

Breite mm: 320
Höhe mm: 127,5
Tiefe mm: 113,1
12V
Radial, 1 Stufe



879043N

Breite mm: 320
Höhe mm: 127,5
Tiefe mm: 113,1
12V
Radial, 3 Stufen



879044N

Breite mm: 320
Höhe mm: 127,5
Tiefe mm: 113,1
12V
Radial, 1 Stufe



879045N

Breite mm: 320
Höhe mm: 127,5
Tiefe mm: 113,1
24V
Radial, 1 Stufe



879049N

Breite mm: 320
Höhe mm: 127,5
Tiefe mm: 113,1
24V
Radial, 3 Stufen



879050N

Innenraumgebläse

Breite mm: 320
Höhe mm: 127,5
Tiefe mm: 113,1
24V
Radial, 1 Stufe



879051N

Breite mm: 320
Höhe mm: 127,5
Tiefe mm: 113,1
24V
Radial, 3 Stufen



879052N

Breite mm: 335
Höhe mm: 163,9
Tiefe mm: 146
24V
Radial, 1 Stufe



879053N

Breite mm: 335
Höhe mm: 163,9
Tiefe mm: 146
24V
Radial, 3 Stufen

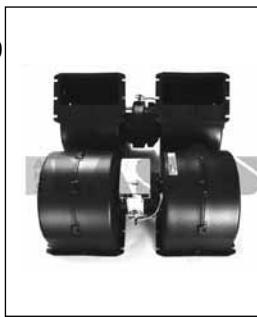

879054N

Breite mm: 335
Höhe mm: 163,9
Tiefe mm: 146
24V
Radial, 4 Stufen



879055N

Breite mm: 335
Höhe mm: 163,9
Tiefe mm: 146
24V
Radial, Drehzahlr,



879056N

Breite mm: 317
Höhe mm: 124,6
Tiefe mm: 111,7
24V
Radial, 3 Stufen



879057N

Breite mm: 317
Höhe mm: 124,6
Tiefe mm: 111,7
24V
Radial, 3 Stufen



879058N

Breite mm: 317
Höhe mm: 124,6
Tiefe mm: 111,7
12V
Radial, 3 Stufen



879060N

Dasis-Duo Power Fan

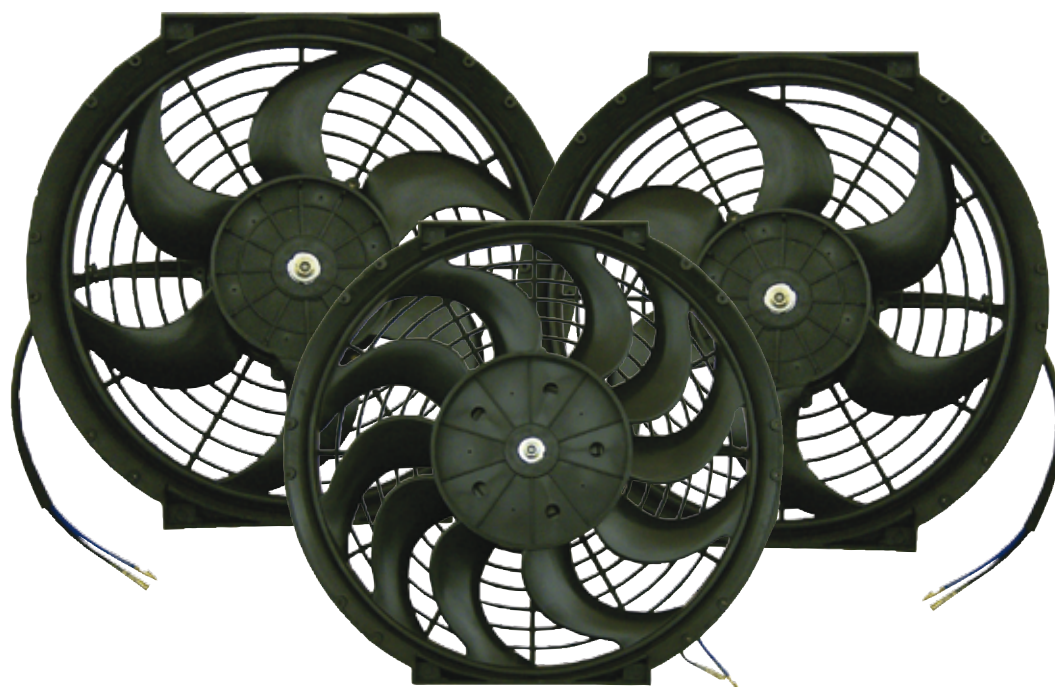

Ø ID mm	Ø AD mm	Höhe mm	Flügel	Spannung	Anlaufstrom	Leistungsaufnahme	Luftdurchgang	Art.-Nr.
190	210	64	10	12V	12A	3,2A	1600m³/h	530011N
225	248	58	10	12V	12,8A	4,8A	2300m³/h	530012N
254	290	60	6	12V	11,8A	3,4A	2050m³/h	530013N
255	288	65	10	6V	17A	7,0A	2200m³/h	530017N
278	318	65	10	6V	17,5A	8,3A	2500m³/h	530018N
288	315	57	10	12V	11,4A	5,8A	2910m³/h	530014N
325	375	67	10	6V	18,2A	6,8A	2900m³/h	530019N
337	375	70	8	12V	20A	8,2A	2820m³/h	530015N
385	414	70	10	12V	21A	7,5A	2700m³/h	530016N*

* Lüfter nur saugend lieferbar

Dasis-Duo Power Fan

Ø ID mm: 190
Ø AD mm: 210
Höhe mm: 64
Flügel: 10
12V



530011N

Ø ID mm: 225
Ø AD mm: 248
Höhe mm: 58
Flügel: 10
12V



530012N

Ø ID mm: 254
Ø AD mm: 290
Höhe mm: 60
Flügel: 6
12V

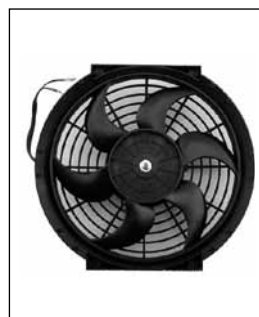

530013N

Ø ID mm: 288
Ø AD mm: 315
Höhe mm: 57
Flügel: 10
12V



530014N

Ø ID mm: 337
Ø AD mm: 375
Höhe mm: 70
Flügel: 8
12V



530015N

Ø ID mm: 385
Ø AD mm: 414
Höhe mm: 70
Flügel: 10
12V



530016N

Ø ID mm: 255
Ø AD mm: 288
Höhe mm: 65
Flügel: 10
6V



530017N

Ø ID mm: 278
Ø AD mm: 318
Höhe mm: 65
Flügel: 10
6V



530018N

Ø ID mm: 325
Ø AD mm: 375
Höhe mm: 67
Flügel: 10
6V

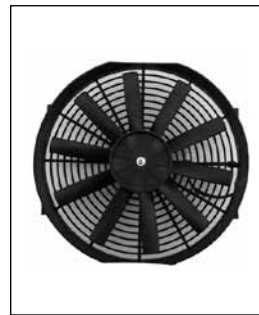

530019N

Verdampfer



820347N

Länge mm: 431, 24V, 3 Ausströmer



820348N

Länge mm: 431, 24V, 3 Ausströmer

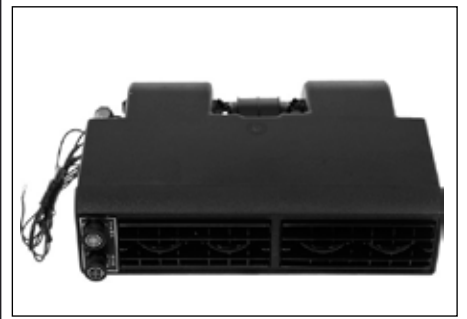

820349N

Länge mm: 381, 12V, 2 Ausströmer

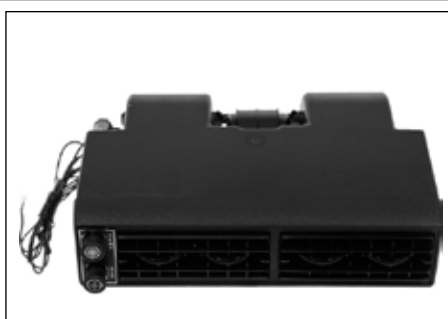

820350N

Länge mm: 381, 12V, 2 Ausströmer



820351N

Länge mm: 406, 12V, 2 Ausströmer

Druckschalter

Einschaltdruck bar: 1,5
Ausschaltdruck bar: 0,5



860016N

Einschaltdruck bar: 2
Ausschaltdruck bar: 0,3
Anschlußgewinde: F
Niedrigdruck



860082N

Einschaltdruck bar: 1
Ausschaltdruck bar: 3
Niedrigdruck



860084N

Anschlußgewinde: F
Binary



860089N

Anschlußgewinde: M
Gewinde: 3/8"
Trinary



860125N

Einschaltdruck bar: 15
Ausschaltdruck bar: 12
Anschlußgewinde: F
Binary



860136N

Anschlußgewinde: M
Trinary



860151N

Anschlußgewinde: M
Gewinde: 3/8"
Binary



860152N

Einschaltdruck bar: 2
Ausschaltdruck bar: 31
Anschlußgewinde: M
Binary



860153N

Einschaltdruck bar: 2
Ausschaltdruck bar: 26,5
Anschlußgewinde: M
Binary



860163N

Einschaltdruck bar: 27
Ausschaltdruck bar: 221,5
Anschlußgewinde: M
Binary



860164N

Anschlußgewinde: M
Binary



860165N

Druckschalter

Einschaltdruck bar: 2
Ausschaltdruck bar: 25
Anschlußgewinde: F
Binary



860166N

Einschaltdruck bar: 15/3
Ausschaltdruck bar: 24/2
Anschlußgewinde: F
Binary



860167N

Anschlußgewinde: F
Binary



860169N

Anschlußgewinde: M
Binary



860171N

Einschaltdruck bar: 21
Ausschaltdruck bar: 2
Anschlußgewinde: M
Binary



860172N

Einschaltdruck bar: 2
Ausschaltdruck bar: 27
Anschlußgewinde: F
Binary

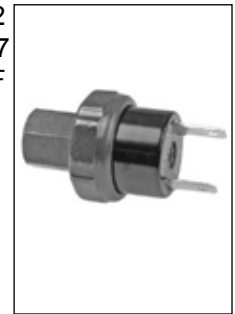

860173N

Einschaltdruck bar: 15/28
Anschlußgewinde: F
Ausschaltdruck bar: 24/2
Binary



860174N

Anschlußgewinde: M
Binary



860175N

Anschlußgewinde: F



860176N

Einschaltdruck bar: 21
Ausschaltdruck bar: 14
Anschlußgewinde: F
Hochdruck



860177N

Einschaltdruck bar: 23
Ausschaltdruck bar: 16
Anschlußgewinde: F
Hochdruck

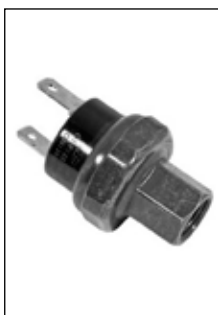

860178N

Einschaltdruck bar: 17
Ausschaltdruck bar: 24
Anschlußgewinde: F
Hochdruck



860179N

Druckschalter

Anschlußgewinde: F



860181N

Einschaltdruck bar: 2
Ausschaltdruck bar: 2
Anschlußgewinde: M
Niedrigdruck



860182N

Einschaltdruck bar: 2
Ausschaltdruck bar: 0,3
Anschlußgewinde: F
Niedrigdruck



860183N

Einschaltdruck bar: 2,3
Anschlußgewinde: F
Ausschaltdruck bar: 0,4



860184N

Einschaltdruck bar: 2
Anschlußgewinde: M
Gewinde: 3/8"
Trinary



860185N

Einschaltdruck bar: 2
Ausschaltdruck bar: 31
Anschlußgewinde: M
Trinary



860186N

Einschaltdruck bar: 2
Ausschaltdruck bar: 31
Anschlußgewinde: M
Trinary



860187N

Einschaltdruck bar: 2
Ausschaltdruck bar: 26
Anschlußgewinde: F
Trinary



860188N

Niedrigdruck
3 Pole



860440N

Trockner

Länge mm: 190
Ø AD mm: 60
Gewindemaß: 3/8"
Gewinde: M
O-Ring

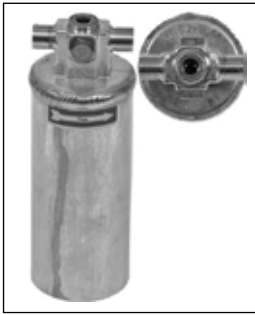

800608N

Länge mm: 190
Ø AD mm: 63
Gewindemaß: 3/8"
Gewinde: M
O-Ring



800604N

Länge mm: 190
Ø AD mm: 63
Gewindemaß: 3/8"
Gewinde: F
O-Ring



800606N

Länge mm: 203
Ø AD mm: 61
Gewindemaß: 3/8"
Gewinde: M
O-Ring



800601N

Länge mm: 203
Ø AD mm: 63
Gewindemaß: 3/8"
Gewinde: F
Konus



800602N

Länge mm: 203
Ø AD mm: 63
Gewindemaß: 3/8"
Gewinde: M/F
O-Ring



800605N

Länge mm: 229
Ø AD mm: 76
Gewindemaß: 3/8"
Gewinde: M
Konus



800603N

Länge mm: 254
Ø AD mm: 63
Gewindemaß: 3/8"
Gewinde: M
O-Ring



800607N

Thermostate

Kap. Lg. mm: 228
Ausschalttemp.: 10°C
Einschalttemp.: 13°C



900098N

Kap. Lg. mm: 279
Ausschalttemp.: -1,1°C
Einschalttemp.: 3,8°C

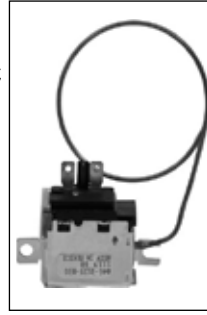

900102N

Kap. Lg. mm: 304
Ausschalttemp.: -2,2°C
Einschalttemp.: 3,8°C

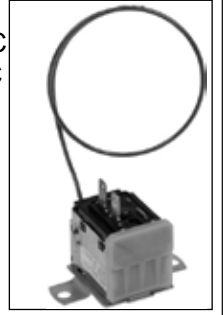

900101N

Kap. Lg. mm: 457
Ausschalttemp.: -4°C
Einschalttemp.: 2,2°C

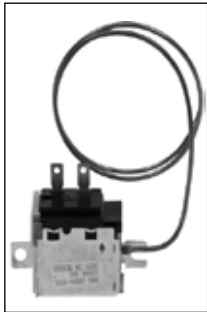

901813N

Kap. Lg. mm: 457
Ausschalttemp.: 1°C
Einschalttemp.: 3,8°C



900104N

Kap. Lg. mm: 457
Ausschalttemp.: -3,3°C
Einschalttemp.: 0,5°C

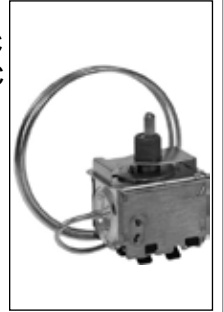

751677N

Kap. Lg. mm: 609



901812N

Kap. Lg. mm: 609



900103N

Kap. Lg. mm: 609
Ausschalttemp.: -0,5°C
Einschalttemp.: 3,8°C



901825N

Kap. Lg. mm: 609
Ausschalttemp.: 1°C
Einschalttemp.: 3,8°C



900099N

Kap. Lg. mm: 609
Ausschalttemp.: -3,3°C
Einschalttemp.: 0,5°C



900111N

Kap. Lg. mm: 609
Ausschalttemp.: -3,3°C
Einschalttemp.: 0,5°C

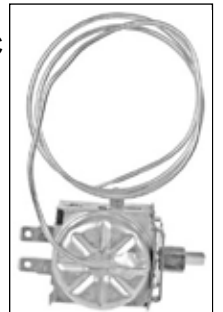

900112N

Thermostate

Kap. Lg. mm: 914
Ausschalttemp.: -3,3°C
Einschalttemp.: 0,5°C



750004N

Kap. Lg. mm: 914
Ausschalttemp.: -3,3°C
Einschalttemp.: 0,5°C



900107N

Kap. Lg. mm: 914
Ausschalttemp.: -2,2°C
Einschalttemp.: 1,6°C



750023N

Kap. Lg. mm: 1210
Ausschalttemp.: -3,3°C
Einschalttemp.: 0,5°C



750005N

Kap. Lg. mm: 1219
Ausschalttemp.: -3,3°C
Einschalttemp.: 0,5°C



900108N

Kap. Lg. mm: 1219
Ausschalttemp.: -3,9°C
Einschalttemp.: 0,5°C



900106N

Kap. Lg. mm: 1219
Ausschalttemp.: -2,7°C
Einschalttemp.: 1°C



900113N

Kap. Lg. mm: 1828
Ausschalttemp.: -2°C
Einschalttemp.: 1°C



750013N

Kap. Lg. mm: 1828
Ausschalttemp.: -3°C
Einschalttemp.: 0,5°C











900114N









Fittinge

Dasis-Nr.	Bezeichnung	Material	Anschl.Gewinde	Ø mm	Gew.	Gew.Maß	Grad	
910837N	Adapter O-Ring/Konus	Aluminium	M/F	6				
910838N	Adapter O-Ring/Konus	Aluminium	M/F	8				
910839N	Adapter O-Ring/Konus	Aluminium	M/F	10				
910841N	Adapter O-Ring/Konus	Aluminium	M/F	8				
908068N	Adapter O-Ring/Konus	Aluminium	M		1/4",38'			
912616N	Adapter O-Ring/Konus	Aluminium		6				
912617N	Adapter O-Ring/Konus	Aluminium		8				
910833N	Adapter O-Ring/Konus	Aluminium		10				
910834N	Adapter O-Ring/Konus	Aluminium		12				
910835N	T Adapter O-Ring	Aluminium	M	6	5/8"			
910836N	T Adapter O-Ring	Aluminium	M	10	5/8"			
910707N	Fitting Konus	Aluminium	F	6	3/8"			
910708N	Fitting Konus	Aluminium	F	8	1/2"			
910688N	Fitting Konus	Aluminium	F	10	5/8"			
910709N	Fitting Konus	Aluminium	F	12	3/4"			
910332N	Fitting Konus	Aluminium	F	6	3/8"		45°C	
910342N	Fitting Konus	Aluminium	F	8	1/2"		45°C	
910352N	Fitting Konus	Aluminium	F	10	5/8"		45°C	
910362N	Fitting Konus	Aluminium	F	12	3/4"		45°C	
910711N	Fitting Konus	Aluminium	F	6	3/8"		45°C	
910712N	Fitting Konus	Aluminium	F	8	1/2"		45°C	
910713N	Fitting Konus	Aluminium	F	10	5/8"		45°C	
910714N	Fitting Konus	Aluminium	F	12	3/4"		45°C	
910412N	Fitting Konus	Aluminium	F	6	3/8"		90°C	
910432N	Fitting Konus	Aluminium	F	8	1/2"		90°C	
910452N	Fitting Konus	Aluminium	F	10	5/8"		90°C	
910472N	Fitting Konus	Aluminium	F	12	3/4"		90°C	

Fittinge

Dasis-Nr.	Bezeichnung	Material	Anschl.Gewinde	Ø mm	Fitting	Gew.Maß	Grad	
910715N	Fitting Konus	Aluminium	F	6	3/8"		90°C	
910716N	Fitting Konus	Aluminium	F	8	1/2"		90°C	
910717N	Fitting Konus	Aluminium	F	10	5/8"		90°C	
910718N	Fitting Konus	Aluminium	F	12	3/4"		90°C	
910222N	T Verbinder	Aluminium		6				
910242N	Fitting Konus	Aluminium	F	8	1/2"			
910262N	Fitting Konus	Aluminium	F	10	5/8"			
910272N	Fitting Konus	Aluminium	F	12	3/4"			
910012N	Fitting Konus	Aluminium	M	6	3/8"			
910022N	Fitting Konus	Aluminium	M	8	1/2"			
910032N	Fitting Konus	Aluminium	M	10	5/8"			
910042N	Fitting Konus	Aluminium	M	12	3/4"			
910092N	Fitting Konus	Aluminium	M	6	3/8"		45°C	
910102N	Fitting Konus	Aluminium	M	8	1/2"		45°C	
910112N	Fitting Konus	Aluminium	M	10	5/8"		45°C	
910745N	Fitting Konus	Aluminium	M	12	3/4"		45°C	
910746N	Fitting Konus	Aluminium	M	6	3/8"		90°C	
910152N	Fitting Konus	Aluminium	M	8	1/2"		90°C	
910162N	Fitting Konus	Aluminium	M	10	5/8"		90°C	
910172N	Fitting Konus	Aluminium	M	12	3/4"		90°C	
910789N	Fitting Konus	Stahl	F	6	3/8"		45°C	
910791N	Fitting Konus	Stahl	F	8	1/2"		45°C	
910793N	Fitting Konus	Stahl	F	10	5/8"		45°C	
910794N	Fitting Konus	Stahl	F	12	3/4"		45°C	
910795N	Fitting Konus	Stahl	F	6	3/8"		90°C	
910796N	Fitting Konus	Stahl	F	8	1/2"		90°C	
910797N	Fitting Konus	Stahl	F	10	5/8"		90°C	
910798N	Fitting Konus	Stahl	F	12	3/4"		90°C	
910811N	Fitting Konus	Stahl	F	6	3/8"			
910812N	Fitting Konus	Stahl	F	8	1/2"			
910813N	Fitting Konus	Stahl	F	10	5/8"			
910814N	Fitting Konus	Stahl	F	12	3/4"			









Fittinge

Dasis-Nr.	Bezeichnung	Material	Anschl.Gewinde	Ø mm	Fitting	Gew.Maß	Grad	
910852N	Fitting O-Ring	Aluminium	F	6	3/8"			
910872N	Fitting O-Ring	Aluminium	F	8	1/2"			
910892N	Fitting O-Ring	Aluminium	F	10	5/8"			
910902N	Fitting O-Ring	Aluminium	F	12	3/4"			
911002N	Fitting O-Ring	Aluminium	F	6	3/8"			
911012N	Fitting O-Ring	Aluminium	F	8	1/2"			
911022N	Fitting O-Ring	Aluminium	F	10	5/8"			
911032N	Fitting O-Ring	Aluminium	F	6	3/8"		45°C	
911042N	Fitting O-Ring	Aluminium	F	8	1/2"		45°C	
911062N	Fitting O-Ring	Aluminium	F	10	5/8"		45°C	
911072N	Fitting O-Ring	Aluminium	F	12	3/4"		45°C	
911032N	Fitting O-Ring	Aluminium	F	6	3/8"		45°C	
911042N	Fitting O-Ring	Aluminium	F	8	1/2"		45°C	
911062N	Fitting O-Ring	Aluminium	F	10	5/8"		45°C	
911072N	Fitting O-Ring	Aluminium	F	12	3/4"		45°C	
910748N	Fitting O-Ring	Aluminium	F	6	3/8"		45°C	
910749N	Fitting O-Ring	Aluminium	F	8	1/2"		45°C	
910751N	Fitting O-Ring	Aluminium	F	10	5/8"		45°C	
910753N	Fitting O-Ring	Aluminium	F	12	3/4"		45°C	
911112N	Fitting O-Ring	Aluminium	F	6	3/8"		90°C	
911132N	Fitting O-Ring	Aluminium	F	8	1/2"		90°C	
911152N	Fitting O-Ring	Aluminium	F	10	5/8"		90°C	
911162N	Fitting O-Ring	Aluminium	F	12	3/4"		90°C	
911322N	Fitting O-Ring	Aluminium	F	6		M14		
911342N	Fitting O-Ring	Aluminium	F	6		M16		
911352N	Fitting O-Ring	Aluminium	F	6		M18		
911362N	Fitting O-Ring	Aluminium	F	6		M20		
910842N	Fitting O-Ring	Aluminium	F	6		M14	45°C	
910765N	Fitting O-Ring	Aluminium	F	6		M16	45°C	
910767N	Fitting O-Ring	Aluminium	F	6		M20	45°C	
911462N	Fitting O-Ring	Aluminium	F	10		M22	45°C	
911472N	Fitting O-Ring	Aluminium	F	10		M24	45°C	
910788N	Fitting O-Ring	Aluminium	F	12		M27	45°C	







Fittinge

Dasis-Nr.	Bezeichnung	Material	Anschl.Gewinde	Ø mm	Fitting	Gew.Maß	Grad	
911252N	Fitting O-Ring	Aluminium	F	6	3/8"		90°C	
911262N	Fitting O-Ring	Aluminium	F	8	1/2"		90°C	
911272N	Fitting O-Ring	Aluminium	F	10	5/8"		90°C	
911282N	Fitting O-Ring	Aluminium	F	6	3/8"		180°C	
911292N	Fitting O-Ring	Aluminium	F	8	1/2"		180°C	
910744N	Fitting O-Ring	Aluminium	F	12	3/4"		180°C	
911492N	Fitting O-Ring	Aluminium	F	6		M14	90°C	
911512N	Fitting O-Ring	Aluminium	F	6		M18	90°C	
911522N	Fitting O-Ring	Aluminium	F	6		M20	90°C	
911532N	Fitting O-Ring	Aluminium	F	8		M20	90°C	
911501N	Fitting O-Ring	Aluminium	F	10		M22	90°C	
910815N	Fitting O-Ring	Stahl	F	6	3/8"		45°C	
910816N	Fitting O-Ring	Stahl	F	8	1/2"		45°C	
910817N	Fitting O-Ring	Stahl	F	10	5/8"		45°C	
910818N	Fitting O-Ring	Stahl	F	12	3/4"		45°C	
910819N	Fitting O-Ring	Stahl	F	6	3/8"		90°C	
910821N	Fitting O-Ring	Stahl	F	8	1/2"		90°C	
910822N	Fitting O-Ring	Stahl	F	10	5/8"		90°C	
910823N	Fitting O-Ring	Stahl	F	12	3/4"		90°C	
910824N	Fitting O-Ring	Stahl	F	6	3/8"		90°C	
910825N	Fitting O-Ring	Stahl	F	8	1/2"		90°C	
910826N	Fitting O-Ring	Stahl	F	10	5/8"		90°C	
910827N	Fitting O-Ring	Stahl	F	12	3/4"		90°C	
910799N	Fitting O-Ring	Stahl	F	6	3/8"			
910801N	Fitting O-Ring	Stahl	F	8	1/2"			
910802N	Fitting O-Ring	Stahl	F	10	5/8"			
910803N	Fitting O-Ring	Stahl	F	12	3/4"			
910804N	Fitting O-Ring	Stahl	F	6	3/8"			
910805N	Fitting O-Ring	Stahl	F	8	1/2"			
910806N	Fitting O-Ring	Stahl	F	10	5/8"			
910807N	Fitting O-Ring	Stahl	F	12	3/4"			





Fittinge

Dasis-Nr.	Bezeichnung	Material	Anschl.Gewinde	Ø mm	Fitting	Gew.Maß	Grad	
910532N	Fitting O-Ring	Aluminium	M	6	3/8"			
910552N	Fitting O-Ring	Aluminium	M	8	1/2"			
910562N	Fitting O-Ring	Aluminium	M	10	5/8"			
910572N	Fitting O-Ring	Aluminium	M	12	3/4"			
910721N	Fitting O-Ring	Aluminium	M	6	3/8"			
910723N	Fitting O-Ring	Aluminium	M	8	1/2"			
910724N	Fitting O-Ring	Aluminium	M	10	5/8"			
910725N	Fitting O-Ring	Aluminium	M	12	3/4"			
910731N	Fitting O-Ring	Aluminium	M	6	3/8"			
910733N	Fitting O-Ring	Aluminium	M	8	1/2"			
910734N	Fitting O-Ring	Aluminium	M	10	5/8"			
910735N	Fitting O-Ring	Aluminium	M	12	5/8"			
910652N	Fitting O-Ring	Aluminium	M	6	3/8"		45°C	
910662N	Fitting O-Ring	Aluminium	M	8	1/2"		45°C	
910672N	Fitting O-Ring	Aluminium	M	10	5/8"		45°C	
910682N	Fitting O-Ring	Aluminium	M	12	3/4"		45°C	
911652N	Fitting O-Ring	Aluminium	M	6	3/8"		45°C	
911662N	Fitting O-Ring	Aluminium	M	8	1/2"		45°C	
911672N	Fitting O-Ring	Aluminium	M	10	5/8"		45°C	
910722N	Fitting O-Ring	Aluminium	M	6	3/8"		90°C	
910732N	Fitting O-Ring	Aluminium	M	8	1/2"		90°C	
910742N	Fitting O-Ring	Aluminium	M	10	5/8"		90°C	
910752N	Fitting O-Ring	Aluminium	M	12	3/4"		90°C	
910726N	Fitting O-Ring	Aluminium	M	6	3/8"		90°C	
910727N	Fitting O-Ring	Aluminium	M	8	1/2"		90°C	
910728N	Fitting O-Ring	Aluminium	M	10	5/8"		90°C	
910729N	Fitting O-Ring	Aluminium	M	12	3/4"		90°C	
911702N	Fitting O-Ring	Aluminium	M	6	3/8"		90°C	
911712N	Fitting O-Ring	Aluminium	M	8	1/2"		90°C	
911722N	Fitting O-Ring	Aluminium	M	10	5/8"		90°C	

























Fittinge

Dasis-Nr.	Bezeichnung	Material	Anschl.Gewinde	Ø mm	Fitting	Gew.Maß	Grad	
911582N	Fitting O-Ring	Aluminium	M	6	3/8"			
911592N	Fitting O-Ring	Aluminium	M	8	1/2"			
911602N	Fitting O-Ring	Aluminium	M	10	5/8"			
911612N	Fitting O-Ring	Aluminium	M	12	3/4"			
910736N	Fitting O-Ring	Stahl		6	3/8"			
910737N	Fitting O-Ring	Stahl		8	1/2"			
910738N	Fitting O-Ring	Stahl		10	5/8"			
910739N	Fitting O-Ring	Stahl		12	3/4"			
912162N	Springlock	Aluminium		6				
912172N	Springlock	Aluminium		8				
912182N	Springlock	Aluminium		10				
912192N	Springlock	Aluminium		12				
912352N	Springlock	Aluminium		6				
912362N	Springlock	Aluminium		8				
912372N	Springlock	Aluminium		10				
912382N	Springlock	Aluminium		12				
912412N	Springlock	Aluminium		6			45°C	
912442N	Springlock	Aluminium		8			45°C	
912452N	Springlock	Aluminium		10			45°C	
912462N	Springlock	Aluminium		12			45°C	
912222N	Springlock	Aluminium		6			45°C	
912232N	Springlock	Aluminium		8			45°C	
912242N	Springlock	Aluminium		10			45°C	
912252N	Springlock	Aluminium		12			45°C	
912482N	Springlock	Aluminium		6			90°C	
912492N	Springlock	Aluminium		8			90°C	
912502N	Springlock	Aluminium		10			90°C	
912512N	Springlock	Aluminium		12			90°C	
912282N	Springlock	Aluminium		6			90°C	
912292N	Springlock	Aluminium		8			90°C	
912302N	Springlock	Aluminium		10			90°C	
912312N	Springlock	Aluminium		12			90°C	

Fittings

Dasis-Nr.	Bezeichnung	Material	Anschl.Gewinde	Ø mm	Fitting	Gew.Maß	Grad	
911972N	Verbinder	Aluminium		6				
911982N	Verbinder	Aluminium		8				
911992N	Verbinder	Aluminium		10				
912002N	Verbinder	Aluminium		12				
911782N	Verbinder	Aluminium		6				
911802N	Verbinder	Aluminium		8				
911822N	Verbinder	Aluminium		10				
911842N	Verbinder	Aluminium		12				
912012N	Verbinder	Aluminium		6			90°C	
912022N	Verbinder	Aluminium		8			90°C	
912032N	Verbinder	Aluminium		10			90°C	
912042N	Verbinder	Aluminium		12			90°C	
912052N	Verbinder	Aluminium		6			180°C	
912062N	Verbinder	Aluminium		8			180°C	
912072N	Verbinder	Aluminium		10			180°C	
912082N	Verbinder	Aluminium		12			180°C	
910828N	Verbinder	Stahl		6				
910829N	Verbinder	Stahl		8				
910831N	Verbinder	Stahl		10				
910832N	Verbinder	Stahl		12				

O-Ringe (Set: 900417N)

<p>900386N Acura, Chrysler, GM, Honda, Isuzu, Lexus, Mitsubishi, Rover, Saab, Toyota</p> 	<p>900456N Infiniti, Nissan</p> 	<p>900307N Alfa Romeo, Audi, Ford-USA, VW</p> 	<p>900387N Volvo</p> 	<p>900308N BMW, Mazda</p> 	<p>900311N Acura, Alfa Romeo, Chrysler, Ford-UK, GM, Honda, Mazda, Mitsubishi, Suzuki</p> 
<p>900388N Volvo</p> 	<p>900309N Acura, Ford-Europe, GM, Honda, Infiniti, Isuzu, Mazda, Mitsubishi, Nissan, Rover, Subaru</p> 	<p>900495N Acura, GM, Honda, Lexus, Mazda, Saab, Toyota</p> 	<p>900389N Acura, Honda, Isuzu, Mazda, Mitsubishi, Rover, Subaru, Suzuki</p> 	<p>900312N Acura, Alfa Romeo, GM, Honda, Infiniti, Isuzu, Jaguar, Lexus, Mazda, Nissan, Rover, Subaru, Toyota</p> 	<p>900356N Acura, Honda, Isuzu, Opel</p> 
<p>900358N Ford-USA, Jaguar</p> 	<p>908287N Chrysler, Ford-Europe/UK/USA, Infiniti, Mazda, Nissan, Opel, Porsche, Rover, Vauxhall</p> 	<p>900458N Citroen, Peugeot</p> 	<p>900313N Acura, Alfa Romeo, BMW, Chrysler, GM, Honda, Isuzu, Jaguar, Mercedes, Mitsubishi, Opel, Rover, Saab, Vauxhall</p> 	<p>900314N Audi, Ford-UK, VW</p> 	<p>900461N Fiat, Renault</p> 
<p>900393N Volvo</p> 	<p>900359N Jaguar</p> 	<p>900463N Fiat</p> 	<p>900391N Rover, Saab</p> 	<p>900315N Audi, Ford-UK, VW</p> 	<p>900317N Acura, Honda, Jaguar, Saab</p> 



1 VE=10Stk.

O-Ringe (Set: 900418N)

900394N Volvo	900361N Jaguar	900392N GM, Rover	900357N Ford-USA, Opel, Vauxhall	900363N GM, Jaguar, Lexus, Toyota	900316N Acura, Chrysler, Ford-Europe/UK/USA, Honda, Infiniti, Isuzu, Nissan
900362N GM, Citroen, Isuzu, Opel, Peugeot, Porsche	900455N Audi, VW	900395N Volvo	900319N Alfa Romeo, BMW, Chrysler, Ford-Europe/UK/USA, GM, Mercedes, Mitsubishi, Opel, Saab, Vauxhall	900464N GM, Lexus, Toyota	908288N Chrysler, Ford-Europe/USA, Infiniti, Mazda, Nissan
900364N Acura, GM, Honda, Isuzu, Opel, Rover, Vauxhall	900322N Isuzu, Mazda, Opel, Porsche, Saab	900321N Audi, VW	900467N Citroen, Peugeot	900368N Jaguar	900325N Acura, Alfa Romeo, BMW, Chrysler, Ford-UK, GM, Honda, Infiniti, Isuzu, Jaguar, Lexus, Mazda, Mercedes, Mitsubishi, Nissan, Opel, Rover, Saab, Subaru, Suzuki, Toyota, Vauxhall
900326N Audi, Ford-UK, VW	900469N Renault	900398N Volvo	900318N BMW, Opel, Vauxhall	900365N Ford-UK/USA, Mazda	900396N Volvo

1 VE=10stk.

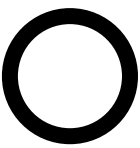
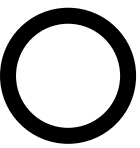
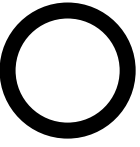
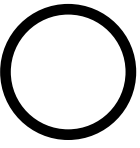
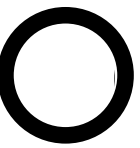
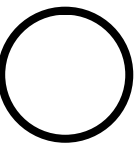
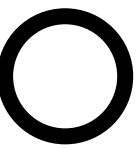
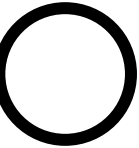
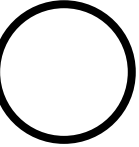
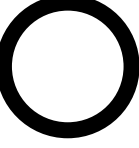
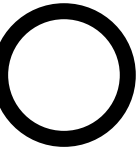
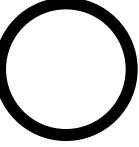
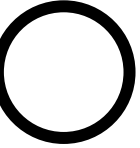
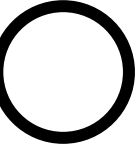
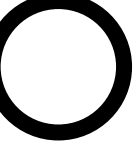
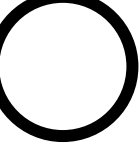
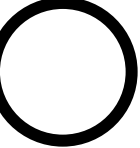
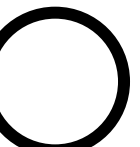
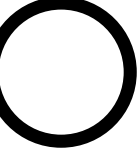
O-Ringe (Set: 900421N)

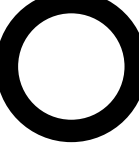
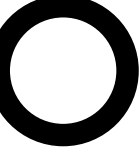
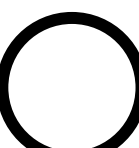
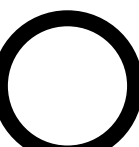
<p>900329N BMW, Rover</p> 	<p>900511N Infiniti, Nissan</p> 	<p>900333N Audi, VW</p> 	<p>900799N Jaguar, Opel</p> 	<p>900328N Alfa Romeo, GM, Isuzu, Opel, Vauxhall</p> 	<p>900485N Fiat</p> 
<p>900486N Acura, Honda, Infiniti, Isuzu, Mazda, Nissan</p> 	<p>908290N Ford-Europe/UK/USA, GM, Mazda</p> 	<p>900493N Mazda</p> 	<p>900494N Saab</p> 	<p>900503N Chrysler, Mitsubishi</p> 	<p>900409N Chrysler, Mitsubishi</p> 
<p>900335N Audi, VW</p> 	<p>900505N Citroen, Fiat, Peugeot</p> 	<p>900508N Isuzu, Suzuki</p> 	<p>900338N Alfa Romeo, BMW, Ford- Europe, GM, Infiniti, Isuzu, Mercedes, Mitsubishi, Nissan, Opel, Saab, Subaru, Vauxhall</p> 	<p>900339N Audi, Ford-UK, VW</p> 	<p>900801N Renault</p> 
<p>900406N Volvo</p> 	<p>900334N Acura, Alfa Romeo, BMW, Ford-USA, Honda, Jaguar, Saab</p> 	<p>900374N Opel, Vauxhall</p> 	<p>900402N Volvo</p> 	<p>900405N Acura, Honda, Porsche</p> 	<p>900337N Audi, VW</p> 

1 VE=10Stk.

O-Ringe (Set: 900422N)

900513N Chrysler, Infiniti, Lexus, Nissan, Subaru, Toyota	900341N Audi, VW	900376N Opel, Vauxhall, Sanden/Zexel Kompressor	900375N Opel, Vauxhall	900711N Isuzu	900407N Volvo
900342N Alfa Romeo	900346N Audi, VW	900377N Acura, Chrysler, Honda, Mazda, Mercedes, Mitsubishi, Saab	900378N Opel	900381N Opel	900343N Acura, Chrysler, Ford, Europe/UK/ USA, GM, Honda, Lexus, Mazda, Mitsubishi, Porsche, Toyota, Vauxhall
900712N Sanden/Zexel Kompressor	900713N Isuzu	900409N Volvo	900382N GM, Isuzu, Opel, Vauxhall	900408N Volvo	900344N Alfa Romeo, Chrysler, Ford, Europe/UK/USA, Infiniti, Jaguar, Mazda, Nissan, Opel, Rover, Saab
900345N Audi, VW	900714N Citroen, Fiat, Peugeot, Renault	900383N Chrysler, GM, Isuzu, Mercedes	900347N BMW	900384N Isuzu, Opel, Saab	900348N Audi, VW





1 VE=10Stk.

Kühlmittelschlauch

Bezeichnung	Ø Innen mm	Länge mm	Dasis-Nr.
Kühlmittelschlauch	6	15000	900340N
Kühlmittelschlauch	8	15000	900350N
Kühlmittelschlauch	10	15000	900360N
Kühlmittelschlauch	12	15000	900370N



Öle / Kältemittel

Typ	Gebinde ml	Dasis-Nr.	
Esteröl	226	900115N	
PAG 46	226	900116N	
Spülmittel	3785	900117N	
PAG Öl	250	900290N	
Kompressor-Öl	1000	900292N	

Werkstattausrüstung

Kältemittelwaage
 •Elektrisch
 •LCD Display
 •9 V Batterie
 •Max.110 kg



901190N

Lecksuchlampen-Kit
 UV, 12V/100W
 Mit UV-Brille.
 Lecksuchadditiv
 für 25 Füllungen.
 Im stabilen Koffer.



901753N

Elektronischer
 Lecksucher mit
 UV-Lampe
 •UV-LED Licht
 •Sicherheitsbrille
 •LED-Anzeige
 •Kunststoffkoffer



901258N

Mini-Lecksuchadditiv
 •mit Schlauch
 •10 Anwendungen



901725N

Lecksuchadditiv
 mit Schlauch
 •25 Anwendungen
 •Mit Handpumpe



901738N

1.
 Lecksuchadditive
 Universal Farböl
 7,4 ml, 6 Stück



901531N

2.
 Universal Farböl
 236 ml Flasche



901533N

3.
 Universal Farböl
 946 ml Flasche



901535N

4.
 Ersatzkartusche
 25 Anwendungen



901534N

5.
 Ersatzkartusche
 10 Anwendungen



900982N

6.
 Universal Farböl
 60 ml Flaschen



908124N

Schnellkupplung
 R134a

Hochdruckseite
 rot 1/4" SAE



901035N

Werkstattausrüstung

Schnellkupplung R134a

Niederdruckseite blau 1/4" SAE



901036N

Schnellkupplung R134a

Hochdruckseite rot 1/4 mm SAE



900130N

Schnellkupplung R134a

Niederdruckseite blau 1/4 mm SAE



900140N

Schnellkupplung R134a beweglich

Hochdruckseite rot 1/4" SAE

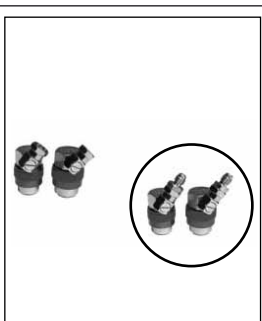

901033N

Schnellkupplung R134a beweglich

Niederdruckseite blau 1/4" SAE



901034N

Schnellkupplung R134a beweglich

Hochdruckseite rot 14 mm SAE



908527N

Schnellkupplung R134a beweglich

Niederdruckseite blau 14 mm SAE



908528N

Schlauchscherer
•Klein
•handlich

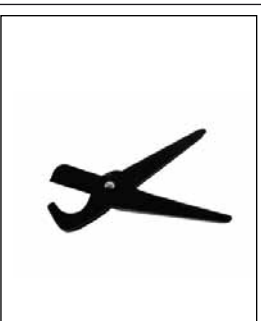

900191N

Schlauchscherer
•Klein
•handlich



900087N

Presswerkzeug für Kältemittel-Armaturen



900086N

Werkzeugsatz zur Demontage von Kupplungsarben



908562N

Werkzeugkasten für Klimakompressoren



908562N

Werkstattausrüstung

Gewindeinstand-
setzungswerkzeug
Schneideisen
metrische



900287N

Gewindeinstand-
setzungswerkzeug
Schneideisen
Zoll-Ausführung



900286N

Infrarot
Handthermometer
mit Laserpointer



900091N

Lamellenkamm
• zum säubern
und Ausrichten
von Lamellen



900059N

Spring-Lock-
Verbindungen



900059N

Spring-Lock für
Opel



900297N

Ventilschlüssel
Universal



900210N

Retrofit-Anschlüsse
Gerade

900830N
Niederdruckseite 1/4"

900840N
Hochdruckseite 1/4"

900850N
Hochdruckseite 3/16"



Retrofit-Anschlüsse
im Winkel

900860N
Niederdruckseite 1/4"

900840N
Hochdruckseite 1/4"

900850N
Hochdruckseite 3/16"



Adapter 1/4"
MFL x 1/4" FFL



908419N

Adapter 1/2"
ACME-M x 1/2"
ACME-F



900984N

Adapter 1/4"
MFL x 1/4" FFL



900120N

Werkstattausrüstung

Adapter 1/4"
MFL x 3/16" FFL



908429N

Adapter 1/4"
FFL x 1/2"
ACME-M

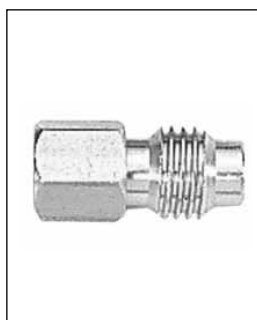

900976N

Adapter 1/4"
1/4" MFL



900973N

Adapter
Kältemittelflasche



908685N

Adapter 1/4"
MFL x 1/4" MFL



900965N

Adapter 1/2"
ACME-M x 1/2"
ACME-F

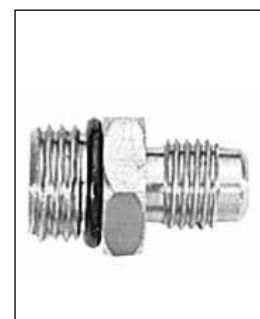

900984N

Pressbacke
Reduziert
6



900169N

Pressbacke
Reduziert
8



900171N

Pressbacke
Reduziert
10



900173N

Pressbacke
Standard
8



900172N

Pressbacke
Standard
10



900033N

Pressbacke
Standard
12



900034N

Werkstattausrüstung

Schlauch
blau
Länge mm: 1820



900460N

Schlauch
gelb
Länge mm: 1820

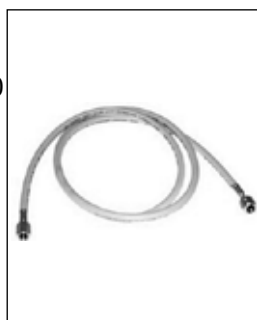

900440N

Schlauch
rot
Länge mm: 1820



901282N

Schlauch
blau
Länge mm: 2438



900044N

Schlauch
gelb
Länge mm: 2438



901304N

Schlauch
rot
Länge mm: 2438



908127N

Springlok
6



912629N

Springlok
10



912631N

Lieferzeiten

Eine umfassende Lagerhaltung und bundesweit modernste Logistik garantieren schnellste Lieferung. Der Versand erfolgt aus 4 Lagerorten in Deutschland. Ob Spedition, Paketdienst, Nachtexpress oder Kurierdienst, wir garantieren schnellste Anlieferung im Tag- und Nachtservice. Das heißt für Sie, im Regelfall sind die bestellten Teile bereits am Morgen des folgenden Tages bei Ihnen.

Versandart	Ab Standort Berlin oder Mülheim-Kärlich	Annahmeschluss	Auslieferung
Tagestour		Vormittag	Nachmittag
DHL Paketservice	bis 31,5 kg	bis 16:30 Uhr	In der Regel am nächsten Werktag
Tagexpress	1-50 kg	bis 17:15 Uhr	Am nächsten Werktag bis 12:00 Uhr
Nachtexpress	1-50 kg	bis 17:15 Uhr	In der Regel bis 8:00 Uhr am nächsten Werktag
Sofortanlieferung auf Anfrage			
Abholung von Reparaturen/Umbauten			
täglich Versand weltweit			

...oder besuchen Sie uns unter www.dasis.de

AKS Dasis Alles für die Motorkühlung und Fahrzeugklimatisierung
 Tel: +49 (0) 1805 / 890 2000*
 * 14 Cent/Min. aus dem Festnetz, max. 42 Cent/Min. Mobil

Home > PKW > zurück

Fahrzeugsuche
 Schlüsselnummer:
 zu 2: zu 3: OK

Artikelsuche
 Hersteller-/Vergleichsnummer: OK

Login für gewerbliche Kunden
 Kd.-Nr.: Passwort: Login
 Logindaten merken
 Neukunde Anmelden

Fahrzeugkategorie
 PKW
 NKW/Busse
 Bus
 Bus Universaltteile
 Land/Baumaschinen

PKW **NKW**
Bus **Bus Zubehör**
Land-/Baumaschinen **Stapler**
Motorrad **Zubehör**

AKS Dasis Alles für die Motorkühlung und Fahrzeugklimatisierung

Home zum Shop Service-Schulungen Logistik Dienstleistungen Anfrage/Retoure

Schnelle Übersicht

Kontakt
 Wir liefern:
 >> Originalkühler und Klimasteile führender Hersteller
 >> Werkstattausrüstung für Klimawartung

Das Programm wird ergänzt durch unsere Werkstattdienstleistungen:
 >> Sonderanfertigungen für die Motorkühlung und Fahrzeugklimatisierung
 >> Tankbau (Serien- und Spezialtanks)
 >> Blecharbeiten
 >> Alu / Stahl-Reparaturschweißungen

zum Shop
 Blitzabfrage
 Newsletter bestellen
 Downloads
 Export
 Flyer/Kataloge

Bestellformular

Firma _____

E-mail _____

Straße _____

Tel. _____

Plz/Ort _____

Kundennummer _____

Datum und Unterschrift

Menge	Artikelbezeichnung	Artikelnummer	Preis

Es gelten die aktuellen AGBs.

Allgemeine Geschäftsbedingungen

Allgemeine Geschäftsbedingungen der AKS DASIS Dommermuth GmbH & Co.KG

1. Allgemeines

Für sämtliche Geschäftsbeziehungen der AKS DASIS Dommermuth GmbH & Co.KG (nachfolgend „Verkäufer“ genannt) gelten ausschließlich die nachfolgenden Allgemeinen Geschäftsbedingungen (AGB) in der jeweils gültigen Fassung. Das Angebot richtet sich ausschließlich an Unternehmer.

2. Angebot, Vertragsabschluss

Die innerhalb des Online-Shops von dem Verkäufer angeführten Produkte und Leistungen stellen keine den Verkäufer bindenden Angebote dar; es handelt sich vielmehr um die Aufforderung an den Kunden, ein verbindliches Angebot durch Abgabe einer Bestellung zu unterbreiten.

Durch Absendung der Bestellung aus dem „virtuellen Warenkorb“ gibt der Kunde eine verbindliche Bestellung über die in diesem enthaltenen Artikel ab. Den Zugang dieser Bestellung wird der Verkäufer dem Kunden unverzüglich per E-Mail bestätigen.

Der Kaufvertrag kommt mit der ausdrücklichen Annahme der Bestellung in Textform oder Auslieferung der Ware durch den Verkäufer zustande. Insoweit ist der Verkäufer berechtigt, das Vertragsangebot des Kunden innerhalb von drei Werktagen nach Eingang der Bestellung anzunehmen.

3. Preise, Hinweis an internationale Käufer

3.1 Preise

Alle genannten Preise sind in EUR inklusive der jeweils gültigen gesetzlichen Mehrwertsteuer (derzeit 19 Prozent Ausnahme Reparaturbücher = 7%) ohne Skonto und sonstige Nachlässe und ohne Kosten von Verpackung und Versand zum Zeitpunkt der Bestellung ausgewiesen. Die Kosten für Verpackung und Versand sind der jeweiligen Artikelbeschreibung zu entnehmen.

3.2 Hinweis an internationale Käufer

3.2.1 Der Artikelpreis bzw. die Versandkosten enthalten keine Einfuhrzölle, Steuern und Gebühren. Für diese Kosten kommt der Käufer auf. Bevor Sie auf einen Artikel bieten oder einen Artikel kaufen, erkundigen Sie sich bitte bei den Zollbehörden Ihres Landes, wie hoch diese Zusatzkosten sein können. Diese Gebühren werden in der Regel vom Versandunternehmen oder Frachtunternehmen bei Lieferung eingezogen oder wenn Sie den Artikel abholen. Bei diesen Gebühren handelt es sich nicht um zusätzliche Versandkosten.

3.2.2 Artikel werden von uns nicht unter Wert oder als Geschenk deklariert. Laut der Gesetze der USA und anderer Länder ist dies nicht zulässig.

3.3 Preiserhöhungen

Bei Preis- und Kostenerhöhungen zwischen Auftragsbestätigung und Lieferung ist der Verkäufer berechtigt, eine entsprechende Berichtigung der Preise vorzunehmen, soweit es sich um Handelsgeschäfte bzw. Geschäfte mit juristischen Personen oder Sondervermögen des öffentlichen Rechts handelt. Bei Geschäften mit Verbrauchern, die innerhalb von vier Monaten nach Bestellung abgewickelt werden, ist der Verkäufer für diesen Zeitraum an die bestätigten Preise gebunden. Bei Bestellungen auf Abruf ist für die Berechnung dieser Frist der Zeitraum zwischen Bestellung und Abruf maßgebend.

4. Eigentumsvorbehalt

Die von dem Verkäufer gelieferte Ware bleibt bis zur vollständigen Bezahlung sein Eigentum.

5. Lieferung; Versandkosten; Gefahrübergang

5.1 Die Lieferung erfolgt zu den jeweils bei der Artikelbeschreibung ausgewiesenen Versandkosten.

5.2 Sofern der Kunde Verbraucher ist, trägt der Verkäufer unabhängig von der Versandart in jedem Fall das Versandrisiko. Sofern der Kunde Unternehmer ist, gehen alle Risiken und Gefahren der Versendung auf den Kunden über, sobald die Ware von dem Verkäufer an den beauftragten Logistikpartner übergeben worden ist.

5.3 Die Liefer- bzw. Leistungsfrist gilt gegenüber Unterneh-

mern auch dann als eingehalten, wenn der Auftragsgegenstand nach Anzeige der Fertigstellung bzw. Abholbereitschaft nicht unverzüglich, spätestens nach einer Woche abgerufen bzw. abgeholt wird. Verzögert sich die Lieferung bzw. Abnahme infolge von Umständen, die der Käufer bzw. Besteller zu vertreten hat, so werden ihm, sofern er Unternehmer ist, nach Ablauf von einer Woche ab Bekanntgabe der Fertigstellung bzw. Abholbereitschaft an gerechnet, die bei dem Verkäufer oder Dritten entstehenden Lagerkosten berechnet. Im gleichen Zeitpunkt geht das Lagerrisiko auf den Käufer bzw. Besteller über. Bleibt der Käufer bzw. Besteller, soweit er Unternehmer ist, nach Anzeige der Bereitstellung mit der Abnahme länger als 2 Wochen in Rückstand, so ist der Verkäufer nach vorheriger Setzung einer Nachfrist von 2 Wochen nach seiner Wahl berechtigt, vom Vertrag zurück zu treten oder Schadensersatz statt der Leistung zu verlangen.

6. Fälligkeit und Zahlung

6.1 Zahlungen haben innerhalb von 30 Tagen nach Ausstellung der Rechnung rein netto ohne Skonto oder sonstige Abzüge zu erfolgen. Bei Zahlungen innerhalb von 14 Tagen ab Rechnungsstellung gewährt der Verkäufer 2 % Skonto.

6.2 Die Annahme von Checks und Wechsel erfolgen nur nach besonderer Vereinbarung, in jedem Falle nur erfüllungshalber, d. h., die Zahlung gilt erst dann als erfolgt, wenn der Wechsel- oder Scheckbetrag dem Konto des Verkäufers unwiderruflich gutgeschrieben wurde.

6.3

Gerät der Käufer bzw. Besteller mit Zahlungen in Verzug, ist der Verkäufer berechtigt, Verzugszinsen in Höhe von 5 Prozentpunkten über dem Basissatz zu fordern. Bei Rechtsgeschäften, an denen ein Verbraucher nicht beteiligt ist, beträgt der Zinssatz für Entgeltforderungen 8 Prozentpunkte über dem Basiszinssatz. Die Geltendmachung weiterer Schäden bleibt vorbehalten. Dem Käufer bzw. Besteller bleibt vorbehalten, einen geringeren Schaden nachzuweisen.

6.4

Kommt der Käufer bzw. Besteller seinen Zahlungsverpflichtungen oder den sich aus dem Eigentumsvorbehalt ergebenden Verpflichtungen nicht oder nicht pünktlich nach, so wird die gesamte Restschuld - auch gestundete Forderungen - sofort fällig, auch soweit Wechsel mit späterer Fälligkeit laufen. Gleiches gilt, wenn dem Verkäufer eine ungünstige Finanzlage des Käufers bzw. Bestellers bekannt wird.

6.5

Der Käufer bzw. Besteller ist zur Aufrechnung nur berechtigt, sofern die Forderungen unbestritten oder rechtskräftig festgestellt wurden. Ein Zurückbehaltungsrecht ist gegenüber Unternehmern ausgeschlossen. Ist der Käufer bzw. Besteller Verbraucher, so stehen ihm Zurückbehaltungsrechte nur aufgrund von Ansprüchen aus dem gleichen Vertragsverhältnis zu.

7. Gewährleistung, Haftung

Für die Haftung und Gewährleistung gelten die gesetzlichen Vorschriften.

Die Gewährleistungsfrist bei gebrauchten Artikeln beträgt 12 Monate. Schadensersatzansprüche bleiben von dieser Regelung unberührt. Etwaige Garantien schränken die gesetzlichen Gewährleistungsansprüche nicht ein.

8. Verbraucherinformationen bei Fernabsatzverträgen über den Erwerb von Waren

8.1 Speziellen und vorstehend nicht erwähnten Verhaltenskodizes unterliegt der Verkäufer nicht.

8.2 Die wesentlichen Merkmale der von dem Verkäufer angebotenen Waren sowie die Gültigkeitsdauer befristeter Angebote entnehmen Sie bitte den einzelnen Produktbeschreibungen im Rahmen des Internetangebotes. Die für den Vertragsabschluss zur Verfügung stehende Sprache ist ausschließlich Deutsch.

8.3 Beanstandungen und Gewährleistungsansprüche können Sie unter der in der Anbieterkennzeichnung angegebenen Adresse vorbringen. Informationen zur Zahlung, Lieferung oder Erfüllung entnehmen Sie bitte dem Angebot.

8.4 Im Onlineshop wird ihre Erklärung erst dann verbindlich, wenn sie die Seite „Rechnungsdanschrift - Zusammenfassung“ erreicht haben und den Button „Bestellung senden“ anklicken. Bis dahin haben Sie die Möglichkeit, Ihre Eingaben zu erkennen und ggf. nach Betätigen des „Zurück“ Button Ihres Browsers auf der vorherigen Seite zu korrigieren oder den Bestellvorgang durch Verlassen der Seite abzubrechen.

8.5 Der Vertragstext und die Ihrerseits eingegebenen Bestelldaten werden von dem Verkäufer gespeichert. Wir schicken Ihnen eine Bestellbestätigung mit allen Angaben an die von Ihnen angegebene E-Mail-Adresse, in welcher Ihnen nochmals alle wesentlichen Daten Ihrer Bestellung mitgeteilt werden. Durch die Druckfunktion Ihres Browsers haben Sie die Möglichkeit, den Vertragstext auszudrucken. Sie haben auch die Möglichkeit, sowohl die Allgemeinen Geschäftsbedingungen als auch Ihre Bestellung mit allen eingegebenen Daten während des Bestellvorgangs auszudrucken. Sie können den Vertragstext auch abspeichern, in dem Sie durch einen Klick auf die rechte Maustaste die Internetseite auf Ihrem Computer abspeichern.

9. Schlussbestimmungen

9.1 Auf das Vertragsverhältnis zwischen dem Verkäufer und dem Kunden sowie auf die jeweiligen Geschäftsbedingungen findet das Recht der Bundesrepublik Deutschland Anwendung. Sofern der Kunde Verbraucher ist, bleiben die nach dem Recht des Aufenthaltslandes des Kunden zu Gunsten des Verbrauchers bestehenden geltenden gesetzlichen Regelungen und Rechte von dieser Vereinbarung unberührt. Die Anwendung von UN-Kaufrecht wird ausgeschlossen.

9.2 Sind vorgenannte Bestimmungen ganz oder teilweise nicht Vertragsbestandteil geworden oder unwirksam, so bleibt der Vertrag im Übrigen wirksam. Soweit die Bestimmungen nicht Vertragsbestandteil geworden oder unwirksam sind, richtet sich der Inhalt des Vertrages nach den gesetzlichen Vorschriften.

9.3 Ausschließlicher Gerichtsstand ist das Gericht unseres Geschäftssitzes soweit der Kunde ein Kaufmann im Sinne des HGB oder eine Körperschaft des öffentlichen Rechts ist.

Hinweise zur Altölsorgung

Altöle sind sowohl brennbare als auch wassergefährdende Flüssigkeiten.

Öle gehören nach Gebrauch in eine Altölannahmestelle! Unsachgemäße Beseitigung von Altöl gefährdet die Umwelt! Jede Beimischung von Fremdstoffen wie Lösemitteln, Brems- und Kühlflüssigkeiten ist verboten.

Unsere nachfolgend genannte Altölannahmestelle nimmt gebrauchte Verbrennungsmotoren- oder Getriebeöle bis zur Menge der im Einzelfall abgegebenen Verbrennungsmotoren- oder Getriebeöle kostenlos an.

AKS Dasis Dommermuth GmbH & Co.KG

Auf dem Hahnenberg 14

56218 Mülheim-Kärlich

Die Rückgabe von Altöl ist grundsätzlich auch an Tankstellen oder bei Wertstoffannahmestellen (z.B. Recyclinghof; evtl. gegen eine Gebühr) möglich. Ob Ihre örtliche Wertstoffannahmestelle Altöl annimmt, erfahren Sie in der Regel vor Ort oder der zuständigen Gemeindeauskunft.

Bei Bedarf nennen wir Ihnen auch eine Altölannahmestelle, bei welcher Sie ihr Altöl entsorgen können.

AKS Dasis Dommermuth GmbH & Co.KG

Auf dem Hahnenberg 14

56218 Mülheim-Kärlich



Engine cooling & Air-conditioning

Wir liefern:

Kühler
Kühler ohne Seitenteile
Ladeluftkühler
Ölkühler
Viscolüfter
Ausgleichsbehälter

Kompressoren
Kondensatoren
Trockner
Verdampfer
Expansionsventile
Gebläse

www.dasis.de

Ihr Spezialist für die Motorkühlung & Fahrzeugklimatisierung

AKS Dasis Dommermuth GmbH & Co. KG

Zentrale: Auf dem Hahnenberg 14 | 56218 Mülheim-Kärlich
Tel: +49 (0) 2630 / 9401-0 | Fax: +49 (0) 2630 / 9401-49

Filiale: Nonnendammallee 32 | 13599 Berlin-Spandau
Tel: +49 (0) 30 / 3331372 | Fax: +49 (0) 30 / 3339661

Mail: info@dasis.de | **Web:** www.dasis.de

www.dasis.de