

# Klimatisierung Land- Baumaschinen





Tabelle: Druckschalter, Klimaanlage (GenArtNr.: 01360).....	2
Tabelle: Elektromotor, Innenraumgebläse (GenArtNr.: 00793).....	34
Tabelle: Expansionsventil, Klimaanlage (GenArtNr.: 00183).....	48
Tabelle: Innenraumgebläse (GenArtNr.: 02669).....	137
Tabelle: Kompressor, Klimaanlage (GenArtNr.: 00447).....	160
Tabelle: Kondensator, Klimaanlage (GenArtNr.: 00448).....	315
Tabelle: Lüfter, Klimakondensator (GenArtNr.: 01254).....	386
Tabelle: Regler (GenArtNr.: 01913).....	387
Tabelle: Relais, Klimaanlage (GenArtNr.: 00803).....	409
Tabelle: Trockner, Klimaanlage (GenArtNr.: 00851).....	423
Tabelle: Verdampfer, Klimaanlage (GenArtNr.: 00471).....	521
Bilder: Druckschalter, Klimaanlage (GenArtNr.: 01360).....	589
Bilder: Elektromotor, Innenraumgebläse (GenArtNr.: 00793).....	594
Bilder: Expansionsventil, Klimaanlage (GenArtNr.: 00183).....	597
Bilder: Gebläseschalter, Heizung/Lüftung (GenArtNr.: 02060).....	604
Bilder: Innenraumgebläse (GenArtNr.: 02669).....	605
Bilder: Kompressor, Klimaanlage (GenArtNr.: 00447).....	610
Bilder: Kondensator, Klimaanlage (GenArtNr.: 00448).....	639
Bilder: Lüfter, Klimakondensator (GenArtNr.: 01254).....	661
Bilder: Regler (GenArtNr.: 01913).....	662
Bilder: Relais, Klimaanlage (GenArtNr.: 00803).....	663
Bilder: Sensor, Innenraumtemperatur (GenArtNr.: 00832).....	665
Bilder: Trockner, Klimaanlage (GenArtNr.: 00851).....	667
Bilder: Verdampfer, Klimaanlage (GenArtNr.: 00471).....	685

Dasis Nr.	Hersteller	Modell	Typ	Spezifikation	Ausstattungsvariante	Anschlussgewinde	Eingangsdruck von [bar]	Ausgangsdruck von [bar]	Anzahl der Steckkontakte
860125N	Bateman	Selbstfahrende Farbspritze / RB	15	Trinary		M			2
860125N	Bateman	Selbstfahrende Farbspritze / RB	16	Trinary		M			2
860126N	Bateman	Selbstfahrende Farbspritze / RB	16			M			
860125N	Bateman	Selbstfahrende Farbspritze / RB	25	Trinary		M			2
860126N	Bateman	Selbstfahrende Farbspritze / RB	25			M			
860127N	Case International IHC	Mähdrescher / 14	1420						
860127N	Case International IHC	Mähdrescher / 14	1440						
860127N	Case International IHC	Mähdrescher / 14	1460						
860578N	Case International IHC	Mähdrescher / 14	1460						1
860127N	Case International IHC	Mähdrescher / 14	1470						
860127N	Case International IHC	Mähdrescher / 14	1480						
860127N	Case International IHC	Mähdrescher / 16	1620						
860578N	Case International IHC	Mähdrescher / 16	1620						1
860578N	Case International IHC	Mähdrescher / 16	1620E						1
860127N	Case International IHC	Mähdrescher / 16	1620E						
860578N	Case International IHC	Mähdrescher / 16	1640						1
860127N	Case International IHC	Mähdrescher / 16	1640						
860578N	Case International IHC	Mähdrescher / 16	1660E						1
860127N	Case International IHC	Mähdrescher / 16	1660E						
860578N	Case International IHC	Mähdrescher / 16	1666						1
860127N	Case International IHC	Mähdrescher / 16	1666						

Dasis Nr.	Hersteller	Modell	Typ	Spezifikation	Ausstattungsvariante	Anschlussgewinde	Eingangsdruck von [bar]	Ausgangsdruck von [bar]	Anzahl der Steckkontakte
860578N	Case International IHC	Mähdrescher / 16	1670						1
860127N	Case International IHC	Mähdrescher / 16	1670						
860578N	Case International IHC	Mähdrescher / 16	1680E						1
860127N	Case International IHC	Mähdrescher / 16	1680E						
860128N	Case International IHC	Mähdrescher / 21	2144						2
860131N	Case International IHC	Mähdrescher / 21	2144						
860131N	Case International IHC	Mähdrescher / 21	2166						
860128N	Case International IHC	Mähdrescher / 21	2166						2
860131N	Case International IHC	Mähdrescher / 21	2188						
860128N	Case International IHC	Mähdrescher / 21	2188						2
860128N	Case International IHC	Mähdrescher / 23	2366						2
860143N	Case International IHC	Mähdrescher / 23	2366						2
860131N	Case International IHC	Mähdrescher / 23	2366						
860142N	Case International IHC	Mähdrescher / 23	2366						2
860141N	Case International IHC	Mähdrescher / CT	5050						
860146N	Case International IHC	Mähdrescher / CT	5050						3
860146N	Case International IHC	Mähdrescher / CT	5060						3
860141N	Case International IHC	Mähdrescher / CT	5060						
860141N	Case International IHC	Mähdrescher / CT	5070						
860146N	Case International IHC	Mähdrescher / CT	5070						3
860146N	Case International IHC	Mähdrescher / CT	5080						3

Dasis Nr.	Hersteller	Modell	Typ	Spezifikation	Ausstattungsvariante	Anschlussgewinde	Eingangsdruck von [bar]	Ausgangsdruck von [bar]	Anzahl der Steckkontakte
860141N	Case International IHC	Mähdrescher / CT	5080						
860127N	Case International IHC	Schlepper / 186-996	595						
860578N	Case International IHC	Schlepper / 186-996	595						1
860127N	Case International IHC	Schlepper / 186-996	695						
860578N	Case International IHC	Schlepper / 186-996	695						1
860127N	Case International IHC	Schlepper / 186-996	795						
860578N	Case International IHC	Schlepper / 186-996	795						1
860578N	Case International IHC	Schlepper / 186-996	856						1
860127N	Case International IHC	Schlepper / 186-996	856						
860127N	Case International IHC	Schlepper / 186-996	895						
860578N	Case International IHC	Schlepper / 186-996	895						1
860127N	Case International IHC	Schlepper / 186-996	955						
860578N	Case International IHC	Schlepper / 186-996	955						1
860578N	Case International IHC	Schlepper / 186-996	956						1
860127N	Case International IHC	Schlepper / 186-996	956						
860578N	Case International IHC	Schlepper / 186-996	995						1
860127N	Case International IHC	Schlepper / 186-996	995						
860127N	Case International IHC	Schlepper / 1046-1896	1055						
860578N	Case International IHC	Schlepper / 1046-1896	1055						1
860127N	Case International IHC	Schlepper / 1046-1896	1056						
860578N	Case International IHC	Schlepper / 1046-1896	1056						1

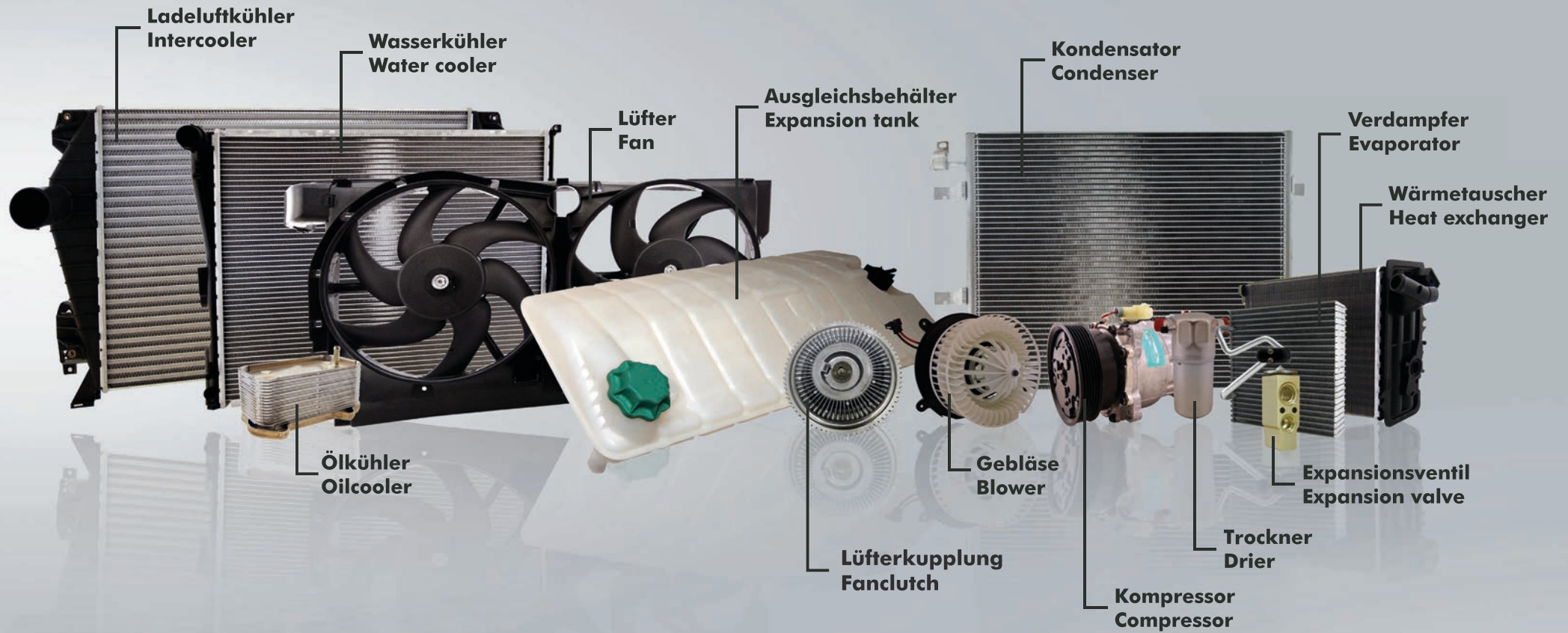
Dasis Nr.	Hersteller	Modell	Typ	Spezifikation	Ausstattungsvariante	Anschlussgewinde	Eingangsdruck von [bar]	Ausgangsdruck von [bar]	Anzahl der Steckkontakte
860127N	Case International IHC	Schlepper / 1046-1896	1255						
860578N	Case International IHC	Schlepper / 1046-1896	1255						1
860127N	Case International IHC	Schlepper / 1046-1896	1455						
860578N	Case International IHC	Schlepper / 1046-1896	1455						1
860131N	Case International IHC	Schlepper / 4000-4894	4210						
860128N	Case International IHC	Schlepper / 4000-4894	4210						2
860128N	Case International IHC	Schlepper / 4000-4894	4220						2
860131N	Case International IHC	Schlepper / 4000-4894	4220						
860131N	Case International IHC	Schlepper / 4000-4894	4230						
860128N	Case International IHC	Schlepper / 4000-4894	4230						2
860128N	Case International IHC	Schlepper / 4000-4894	4240						2
860131N	Case International IHC	Schlepper / 4000-4894	4240						
860131N	Case International IHC	Schlepper / 5088-5488	5120						
860144N	Case International IHC	Schlepper / 5088-5488	5120						
860128N	Case International IHC	Schlepper / 5088-5488	5120						2
860132N	Case International IHC	Schlepper / 5088-5488	5120						2
860131N	Case International IHC	Schlepper / 5088-5488	5130						
860144N	Case International IHC	Schlepper / 5088-5488	5130						
860128N	Case International IHC	Schlepper / 5088-5488	5130						2
860132N	Case International IHC	Schlepper / 5088-5488	5130						2
860131N	Case International IHC	Schlepper / 5088-5488	5140						

Dasis Nr.	Hersteller	Modell	Typ	Spezifikation	Ausstattungsvariante	Anschlussgewinde	Eingangsdruck von [bar]	Ausgangsdruck von [bar]	Anzahl der Steckkontakte
860132N	Case International IHC	Schlepper / 5088-5488	5140						2
860144N	Case International IHC	Schlepper / 5088-5488	5140						
860128N	Case International IHC	Schlepper / 5088-5488	5140						2
860144N	Case International IHC	Schlepper / 5088-5488	5150						
860131N	Case International IHC	Schlepper / 5088-5488	5150						
860132N	Case International IHC	Schlepper / 5088-5488	5150						2
860128N	Case International IHC	Schlepper / 5088-5488	5150						2
860131N	Case International IHC	Schlepper / 7110-7488	7220						
860128N	Case International IHC	Schlepper / 7110-7488	7220						2
860131N	Case International IHC	Schlepper / 7110-7488	7230						
860128N	Case International IHC	Schlepper / 7110-7488	7230						2
860131N	Case International IHC	Schlepper / 7110-7488	7240						
860128N	Case International IHC	Schlepper / 7110-7488	7240						2
860136N	Case International IHC	Schlepper / CS	75	Binary		F	15	12	1
860136N	Case International IHC	Schlepper / CS	78	Binary		F	15	12	1
860136N	Case International IHC	Schlepper / CS	86	Binary		F	15	12	1
860136N	Case International IHC	Schlepper / CS	94	Binary		F	15	12	1
860136N	Case International IHC	Schlepper / CS	100	Binary		F	15	12	1
860136N	Case International IHC	Schlepper / CS	110	Binary		F	15	12	1
860136N	Case International IHC	Schlepper / CS	120	Binary		F	15	12	1
860136N	Case International IHC	Schlepper / CS	130	Binary		F	15	12	1



Dasis Nr.	Hersteller	Modell	Typ	Spezifikation	Ausstattungsvariante	Anschlussgewinde	Eingangsdruck von [bar]	Ausgangsdruck von [bar]	Anzahl der Steckkontakte
860136N	Case International IHC	Schlepper / CS	150	Binary		F	15	12	1
860128N	Case International IHC	Schlepper / CX	50						2
860131N	Case International IHC	Schlepper / CX	50						
860128N	Case International IHC	Schlepper / CX	60						2
860131N	Case International IHC	Schlepper / CX	60						
860131N	Case International IHC	Schlepper / CX	70						
860128N	Case International IHC	Schlepper / CX	70						2
860128N	Case International IHC	Schlepper / CX	80						2
860131N	Case International IHC	Schlepper / CX	80						
860131N	Case International IHC	Schlepper / CX	90						
860128N	Case International IHC	Schlepper / CX	90						2
860131N	Case International IHC	Schlepper / CX	100						
860128N	Case International IHC	Schlepper / CX	100						2
860128N	Case International IHC	Schlepper / Magnum	7220						2
860131N	Case International IHC	Schlepper / Magnum	7220						
860128N	Case International IHC	Schlepper / Magnum	7230						2
860131N	Case International IHC	Schlepper / Magnum	7230						
860128N	Case International IHC	Schlepper / Magnum	7240						2
860131N	Case International IHC	Schlepper / Magnum	7240						
860128N	Case International IHC	Schlepper / Magnum	7250						2
860131N	Case International IHC	Schlepper / Magnum	7250						

Dasis Nr.	Hersteller	Modell	Typ	Spezifikation	Ausstattungsvariante	Anschlussgewinde	Eingangsdruck von [bar]	Ausgangsdruck von [bar]	Anzahl der Steckkontakte
860142N	Case International IHC	Schlepper / MX	100						2
860142N	Case International IHC	Schlepper / MX	110						2
860142N	Case International IHC	Schlepper / MX	120						2
860142N	Case International IHC	Schlepper / MX	135						2
860142N	Case International IHC	Schlepper / MX	150						2
860142N	Case International IHC	Schlepper / MX	170						2
860142N	Case International IHC	Schlepper / MX	180						2
860142N	Case International IHC	Schlepper / MX	200						2
860143N	Case International IHC	Schlepper / MX	210						2
860142N	Case International IHC	Schlepper / MX	220						2
860143N	Case International IHC	Schlepper / MX	230						2
860142N	Case International IHC	Schlepper / MX	240						2
860143N	Case International IHC	Schlepper / MX	255						2
860142N	Case International IHC	Schlepper / MX	270						2
860143N	Case International IHC	Schlepper / MX	285						2
860131N	Case International IHC	Schlepper / MXC	80						
860128N	Case International IHC	Schlepper / MXC	80						2
860131N	Case International IHC	Schlepper / MXC	90						
860128N	Case International IHC	Schlepper / MXC	90						2
860131N	Case International IHC	Schlepper / MXC	100						
860128N	Case International IHC	Schlepper / MXC	100						2

Dasis Nr.	Hersteller	Modell	Typ	Spezifikation	Ausstattungsvariante	Anschlussgewinde	Eingangsdruck von [bar]	Ausgangsdruck von [bar]	Anzahl der Steckkontakte
860148N	Case International IHC	Schlepper / MXM	120						2
860133N	Case International IHC	Schlepper / MXM	120			F			4
860148N	Case International IHC	Schlepper / MXM	130						2
860133N	Case International IHC	Schlepper / MXM	130			F			4
860133N	Case International IHC	Schlepper / MXM	135			F			4
860148N	Case International IHC	Schlepper / MXM	140						2
860133N	Case International IHC	Schlepper / MXM	140			F			4
860133N	Case International IHC	Schlepper / MXM	150			F			4
860148N	Case International IHC	Schlepper / MXM	155						2
860133N	Case International IHC	Schlepper / MXM	155			F			4
860133N	Case International IHC	Schlepper / MXM	165			F			4
860148N	Case International IHC	Schlepper / MXM	175						2
860133N	Case International IHC	Schlepper / MXM	175			F			4
860133N	Case International IHC	Schlepper / MXM	180			F			4
860148N	Case International IHC	Schlepper / MXM	190						2
860133N	Case International IHC	Schlepper / MXM	190			F			4
860148N	Case International IHC	Schlepper / MXU	100						2
860133N	Case International IHC	Schlepper / MXU	100			F			4
860148N	Case International IHC	Schlepper / MXU	110						2
860133N	Case International IHC	Schlepper / MXU	110			F			4
860148N	Case International IHC	Schlepper / MXU	115						2

Dasis Nr.	Hersteller	Modell	Typ	Spezifikation	Ausstattungsvariante	Anschlussgewinde	Eingangsdruck von [bar]	Ausgangsdruck von [bar]	Anzahl der Steckkontakte
860133N	Case International IHC	Schlepper / MXU	115			F			4
860148N	Case International IHC	Schlepper / MXU	125						2
860133N	Case International IHC	Schlepper / MXU	125			F			4
860148N	Case International IHC	Schlepper / MXU	130						2
860133N	Case International IHC	Schlepper / MXU	130			F			4
860148N	Case International IHC	Schlepper / MXU	135						2
860133N	Case International IHC	Schlepper / MXU	135			F			4
860142N	Case International IHC	Schlepper / STX	275						2
860143N	Case International IHC	Schlepper / STX	275						2
860142N	Case International IHC	Schlepper / STX	325						2
860143N	Case International IHC	Schlepper / STX	325						2
860142N	Case International IHC	Schlepper / STX	375						2
860142N	Case International IHC	Schlepper / STX	425						2
860142N	Case International IHC	Schlepper / STX	440						2
860142N	Case International IHC	Schlepper / STX	450						2
860142N	Case International IHC	Schlepper / STX	500						2
860578N	Claas	Feldhäcksler / Jaguar	685						1
860578N	Claas	Feldhäcksler / Jaguar	690						1
860578N	Claas	Feldhäcksler / Jaguar	695						1
860099N	Claas	Feldhäcksler / Jaguar	860						
860125N	Claas	Feldhäcksler / Jaguar	860	Trinary		M			2
860099N	Claas	Feldhäcksler / Jaguar	880						
860125N	Claas	Feldhäcksler / Jaguar	880	Trinary		M			2
860578N	Claas	Feldhäcksler / Mega	202						1

Dasis Nr.	Hersteller	Modell	Typ	Spezifikation	Ausstattungsvariante	Anschlussgewinde	Eingangsdruck von [bar]	Ausgangsdruck von [bar]	Anzahl der Steckkontakte
860578N	Claas	Feldhäcksler / Mega	203						1
860578N	Claas	Feldhäcksler / Mega	204						1
860578N	Claas	Feldhäcksler / Mega	208						1
860578N	Claas	Feldhäcksler / Mega	218						1
860578N	Claas	Mähdrescher / Dominator 6	56						1
860097N	Claas	Mähdrescher / Dominator 6	56						
860578N	Claas	Mähdrescher / Dominator 6	66						1
860097N	Claas	Mähdrescher / Dominator 6	66						
860097N	Claas	Mähdrescher / Dominator 6	76						
860578N	Claas	Mähdrescher / Dominator 6	76						1
860578N	Claas	Mähdrescher / Dominator 6	86						1
860097N	Claas	Mähdrescher / Dominator 6	86						
860097N	Claas	Mähdrescher / Dominator 6	96						
860578N	Claas	Mähdrescher / Dominator 6	96						1
860097N	Claas	Mähdrescher / Dominator 6	106						
860578N	Claas	Mähdrescher / Dominator 6	106						1
860097N	Claas	Mähdrescher / Dominator 6	116						
860578N	Claas	Mähdrescher / Dominator 6	116						1
860578N	Claas	Mähdrescher / Dominator 8	98						1
860097N	Claas	Mähdrescher / Dominator 8	98						
860125N	Claas	Mähdrescher / Lexion	410	Trinary		M			2
860125N	Claas	Mähdrescher / Lexion	420	Trinary		M			2
860125N	Claas	Mähdrescher / Lexion	430	Trinary		M			2

Dasis Nr.	Hersteller	Modell	Typ	Spezifikation	Ausstattungsvariante	Anschlussgewinde	Eingangsdruck von [bar]	Ausgangsdruck von [bar]	Anzahl der Steckkontakte
860125N	Claas	Mähdrescher / Lexion	450	Trinary		M			2
860125N	Claas	Mähdrescher / Lexion	460	Trinary		M			2
860125N	Claas	Mähdrescher / Lexion	480	Trinary		M			2
860097N	Claas	Mähdrescher / Mega	202						
860097N	Claas	Mähdrescher / Mega	203						
860097N	Claas	Mähdrescher / Mega	204						
860097N	Claas	Mähdrescher / Mega	208						
860097N	Claas	Mähdrescher / Mega	218						
860127N	Claas	Schlepper	Diverse						
860129N	Claas	Targo	40						
860129N	Claas	Targo	50						
860129N	Claas	Targo	K50						
860129N	Claas	Targo	K60						
860129N	Claas	Targo	K70						
860125N	Claas	Teleskopklader / Lexion	410	Trinary		M			2
860125N	Claas	Teleskopklader / Lexion	420	Trinary		M			2
860125N	Claas	Teleskopklader / Lexion	430	Trinary		M			2
860125N	Claas	Teleskopklader / Lexion	450	Trinary		M			2
860125N	Claas	Teleskopklader / Lexion	460	Trinary		M			2
860125N	Claas	Teleskopklader / Lexion	480	Trinary		M			2
860125N	Claas	Teleskopklader / Ranger	920	Trinary		M			2
860125N	Claas	Teleskopklader / Ranger	925	Trinary		M			2
860125N	Claas	Teleskopklader / Ranger	928	Trinary		M			2
860125N	Claas	Teleskopklader / Ranger	964	Trinary		M			2
860125N	Claas	Teleskopklader / Ranger	965	Trinary		M			2

Dasis Nr.	Hersteller	Modell	Typ	Spezifikation	Ausstattungsvariante	Anschlussgewinde	Eingangsdruck von [bar]	Ausgangsdruck von [bar]	Anzahl der Steckkontakte
860125N	Claas	Teleskoplader / Ranger	974	Trinary		M			2
860125N	Claas	Teleskoplader / Ranger	975	Trinary		M			2
860137N	Deutz	Schlepper / DX3	3.10						
860137N	Deutz	Schlepper / DX3	3.30						
860137N	Deutz	Schlepper / DX3	3.50						
860137N	Deutz	Schlepper / DX3	3.60						
860137N	Deutz	Schlepper / DX3	3.65						
860137N	Deutz	Schlepper / DX3	3.70						
860137N	Deutz	Schlepper / DX3	3.80						
860137N	Deutz	Schlepper / DX3	3.90						
860578N	Deutz	Schlepper / DX4	4.10						1
860578N	Deutz	Schlepper / DX4	4.30						1
860578N	Deutz	Schlepper / DX4	4.50						1
860578N	Deutz	Schlepper / DX4	4.70						1
860578N	Deutz	Schlepper / DX6	6.05						1
860578N	Deutz	Schlepper / DX6	6.10						1
860578N	Deutz	Schlepper / DX6	6.30						1
860578N	Deutz	Schlepper / DX6	6.50						1
860578N	Deutz	Schlepper / DX7	7.10						1
860617N	Fendt	Mähdrescher / 6270-6350	6300						
860617N	Fendt	Mähdrescher / 6270-6350	6330						
860617N	Fendt	Mähdrescher / 8300-8350	8300						
860617N	Fendt	Mähdrescher / 8300-8350	8350						
860153N	Fendt	Schlepper / Farmer 300	304	Binary		M	2	31	2
860153N	Fendt	Schlepper / Farmer 300	305	Binary		M	2	31	2
860153N	Fendt	Schlepper / Farmer 300	306	Binary		M	2	31	2
860153N	Fendt	Schlepper / Farmer 300	307	Binary		M	2	31	2

Dasis Nr.	Hersteller	Modell	Typ	Spezifikation	Ausstattungsvariante	Anschlussgewinde	Eingangsdruck von [bar]	Ausgangsdruck von [bar]	Anzahl der Steckkontakte
860153N	Fendt	Schlepper / Farmer 300	308	Binary		M	2	31	2
860153N	Fendt	Schlepper / Farmer 300	309	Binary		M	2	31	2
860153N	Fendt	Schlepper / Farmer 300	310	Binary		M	2	31	2
860153N	Fendt	Schlepper / Farmer 300	311	Binary		M	2	31	2
860153N	Fendt	Schlepper / Farmer 300	312	Binary		M	2	31	2
860153N	Fendt	Schlepper / Favorit 500	509	Binary		M	2	31	2
860153N	Fendt	Schlepper / Favorit 500	510	Binary		M	2	31	2
860153N	Fendt	Schlepper / Favorit 500	511	Binary		M	2	31	2
860153N	Fendt	Schlepper / Favorit 500	512	Binary		M	2	31	2
860153N	Fendt	Schlepper / Favorit 500	514	Binary		M	2	31	2
860153N	Fendt	Schlepper / Favorit 500	515	Binary		M	2	31	2
860153N	Fendt	Schlepper / Favorit 600	600	Binary		M	2	31	2
860153N	Fendt	Schlepper / Favorit 600	610	Binary		M	2	31	2
860153N	Fendt	Schlepper / Favorit 600	611	Binary		M	2	31	2
860153N	Fendt	Schlepper / Favorit 600	612	Binary		M	2	31	2
860153N	Fendt	Schlepper / Favorit 600	614	Binary		M	2	31	2
860153N	Fendt	Schlepper / Favorit 600	615	Binary		M	2	31	2
860153N	Fendt	Schlepper / Favorit 800	816	Binary		M	2	31	2
860153N	Fendt	Schlepper / Favorit 800	818	Binary		M	2	31	2
860153N	Fendt	Schlepper / Favorit 800	822	Binary		M	2	31	2
860153N	Fendt	Schlepper / Favorit 800	824	Binary		M	2	31	2



Dasis Nr.	Hersteller	Modell	Typ	Spezifikation	Ausstattungsvariante	Anschlussgewinde	Eingangsdruck von [bar]	Ausgangsdruck von [bar]	Anzahl der Steckkontakte
860153N	Fendt	Schlepper / Favorit 900	916	Binary		M	2	31	2
860153N	Fendt	Schlepper / Favorit 900	920	Binary		M	2	31	2
860153N	Fendt	Schlepper / Favorit 900	924	Binary		M	2	31	2
860153N	Fendt	Schlepper / Favorit 900	926	Binary		M	2	31	2
860204N	Fendt	Schlepper / Vario	207						2
860204N	Fendt	Schlepper / Vario	208						2
860204N	Fendt	Schlepper / Vario	209						2
860204N	Fendt	Schlepper / Vario	210						2
860204N	Fendt	Schlepper / Vario	211						2
860204N	Fendt	Schlepper / Vario	309						2
860204N	Fendt	Schlepper / Vario	310						2
860204N	Fendt	Schlepper / Vario	311						2
860204N	Fendt	Schlepper / Vario	312						2
860204N	Fendt	Schlepper / Vario	313						2
860204N	Fendt	Schlepper / Vario	411						2
860204N	Fendt	Schlepper / Vario	412						2
860204N	Fendt	Schlepper / Vario	413						2
860204N	Fendt	Schlepper / Vario	414						2
860204N	Fendt	Schlepper / Vario	415						2
860204N	Fendt	Schlepper / Vario	512						2
860204N	Fendt	Schlepper / Vario	513						2
860204N	Fendt	Schlepper / Vario	514						2
860204N	Fendt	Schlepper / Vario	516						2
860204N	Fendt	Schlepper / Vario	711						2
860204N	Fendt	Schlepper / Vario	712						2
860204N	Fendt	Schlepper / Vario	714						2
860204N	Fendt	Schlepper / Vario	716						2
860204N	Fendt	Schlepper / Vario	718						2
860204N	Fendt	Schlepper / Vario	720						2
860204N	Fendt	Schlepper / Vario	722						2

Dasis Nr.	Hersteller	Modell	Typ	Spezifikation	Ausstattungsvariante	Anschlussgewinde	Eingangsdruck von [bar]	Ausgangsdruck von [bar]	Anzahl der Steckkontakte
860204N	Fendt	Schlepper / Vario	724						2
860204N	Fendt	Schlepper / Vario	815						2
860204N	Fendt	Schlepper / Vario	817						2
860204N	Fendt	Schlepper / Vario	818						2
860204N	Fendt	Schlepper / Vario	819						2
860204N	Fendt	Schlepper / Vario	820						2
860204N	Fendt	Schlepper / Vario	822						2
860204N	Fendt	Schlepper / Vario	824						2
860204N	Fendt	Schlepper / Vario	826						2
860204N	Fendt	Schlepper / Vario	828						2
860204N	Fendt	Schlepper / Vario	916						2
860204N	Fendt	Schlepper / Vario	918A						2
860204N	Fendt	Schlepper / Vario	920						2
860204N	Fendt	Schlepper / Vario	922						2
860204N	Fendt	Schlepper / Vario	924						2
860204N	Fendt	Schlepper / Vario	926						2
860204N	Fendt	Schlepper / Vario	927						2
860204N	Fendt	Schlepper / Vario	930						2
860204N	Fendt	Schlepper / Vario	933						2
860204N	Fendt	Schlepper / Vario	936						2
860204N	Fendt	Schlepper / Vario	939						2
860153N	Fendt	Schlepper / Xylon	520	Binary		M	2	31	2
860153N	Fendt	Schlepper / Xylon	522	Binary		M	2	31	2
860153N	Fendt	Schlepper / Xylon	524	Binary		M	2	31	2
860127N	JCB	Baggerlader	RTFL						
860127N	JCB	Teleskoplader / 500 Serie	520HL						
860127N	JCB	Teleskoplader / 500 Serie	520M						
860127N	JCB	Teleskoplader / 500 Serie	520S						
860127N	JCB	Teleskoplader / 500 Serie	525						

Dasis Nr.	Hersteller	Modell	Typ	Spezifikation	Ausstattungsvariante	Anschlussgewinde	Eingangsdruck von [bar]	Ausgangsdruck von [bar]	Anzahl der Steckkontakte
860127N	JCB	Teleskoplader / 500 Serie	525B						
860189N	John Deere	Baggerlader / 110-726B	300						
860189N	John Deere	Mähdrescher / CTS	7000						
860124N	John Deere	Mähdrescher / CTS	CTS						
860123N	John Deere	Mähdrescher / CTS	CTS						
860123N	John Deere	Mähdrescher / CTS	CTS II						
860124N	John Deere	Mähdrescher / CTS	CTS II						
860189N	John Deere	Mähdrescher / CTS	CTS II						
860191N	John Deere	Schlepper / 5000-5820	5010						
860123N	John Deere	Schlepper / 5000-5820	5200						
860123N	John Deere	Schlepper / 5000-5820	5300						
860124N	John Deere	Schlepper / 5000-5820	5310						
860123N	John Deere	Schlepper / 5000-5820	5400						
860124N	John Deere	Schlepper / 5000-5820	5410						
860123N	John Deere	Schlepper / 5000-5820	5500						
860124N	John Deere	Schlepper / 5000-5820	5510						
860619N	John Deere	Schlepper / 6000-6930	6110			F			2
860619N	John Deere	Schlepper / 6000-6930	6110M			F			2
860619N	John Deere	Schlepper / 6000-6930	6110R			F			2
860619N	John Deere	Schlepper / 6000-6930	6110RC			F			2
860619N	John Deere	Schlepper / 6000-6930	6110SE			F			2
860619N	John Deere	Schlepper / 6000-6930	6200			F			2
860619N	John Deere	Schlepper / 6000-6930	6200SE			F			2

Dasis Nr.	Hersteller	Modell	Typ	Spezifikation	Ausstattungsvariante	Anschlussgewinde	Eingangsdruck von [bar]	Ausgangsdruck von [bar]	Anzahl der Steckkontakte
860619N	John Deere	Schlepper / 6000-6930	6210			F			2
860619N	John Deere	Schlepper / 6000-6930	6210R			F			2
860619N	John Deere	Schlepper / 6000-6930	6210SE			F			2
860619N	John Deere	Schlepper / 6000-6930	6220			F			2
860619N	John Deere	Schlepper / 6000-6930	6220SE			F			2
860619N	John Deere	Schlepper / 6000-6930	6230			F			2
860619N	John Deere	Schlepper / 6000-6930	6230R			F			2
860619N	John Deere	Schlepper / 6000-6930	6310			F			2
860619N	John Deere	Schlepper / 6000-6930	6310SE			F			2
860619N	John Deere	Schlepper / 6000-6930	6320			F			2
860619N	John Deere	Schlepper / 6000-6930	6320SE			F			2
860619N	John Deere	Schlepper / 6000-6930	6330			F			2
860619N	John Deere	Schlepper / 6000-6930	6400			F			2
860619N	John Deere	Schlepper / 6000-6930	6400SE			F			2
860189N	John Deere	Schlepper / 7000-7920	7000						
860123N	John Deere	Schlepper / 7000-7920	7600						
860124N	John Deere	Schlepper / 7000-7920	7610						
860123N	John Deere	Schlepper / 7000-7920	7700						
860124N	John Deere	Schlepper / 7000-7920	7710						
860123N	John Deere	Schlepper / 7000-7920	7800						
860124N	John Deere	Schlepper / 7000-7920	7810						

Dasis Nr.	Hersteller	Modell	Typ	Spezifikation	Ausstattungsvariante	Anschlussgewinde	Eingangsdruck von [bar]	Ausgangsdruck von [bar]	Anzahl der Steckkontakte
860189N	John Deere	Schlepper / 8000-8640	8000						
860191N	John Deere	Schlepper / 8000-8640	8010						
860189N	John Deere	Schlepper / 8000-8640	8010T						
860123N	John Deere	Schlepper / 8000-8640	8100						
860124N	John Deere	Schlepper / 8000-8640	8110						
860123N	John Deere	Schlepper / 8000-8640	8200						
860124N	John Deere	Schlepper / 8000-8640	8210						
860123N	John Deere	Schlepper / 8000-8640	8300						
860124N	John Deere	Schlepper / 8000-8640	8310						
860123N	John Deere	Schlepper / 8000-8640	8400						
860124N	John Deere	Schlepper / 8000-8640	8410						
860189N	John Deere	Schlepper / CTS	CTS II						
860191N	John Deere	Schlepper / CTS	CTS II						
860123N	John Deere	Teleskoplader / CTS	CTS						
860191N	John Deere	Teleskoplader / CTS	CTS						
860123N	John Deere	Teleskoplader / CTS	CTS II						
860191N	John Deere	Teleskoplader / CTS	CTS II						
860138N	Komatsu	Schlepper	SonstigeModelle						
860137N	Komatsu	Schlepper	SonstigeModelle						
860147N	Komatsu	Schlepper	SonstigeModelle						
860145N	Komatsu	Schlepper	SonstigeModelle			F			
750001N	Landini	Schlepper / 6880-9880	8880V						
750001N	Landini	Schlepper / 6880-9880	9080						
750001N	Landini	Schlepper / 6880-9880	9080H						
750001N	Landini	Schlepper / 6880-9880	9880						

Dasis Nr.	Hersteller	Modell	Typ	Spezifikation	Ausstattungsvariante	Anschlussgewinde	Eingangsdruck von [bar]	Ausgangsdruck von [bar]	Anzahl der Steckkontakte
750001N	Landini	Schlepper / 6880-9880	9880H						
750001N	Landini	Schlepper / Large	10000						
750001N	Landini	Schlepper / Large	10000S						
750001N	Landini	Schlepper / Large	12500						
750001N	Landini	Schlepper / Large	13000						
750001N	Landini	Schlepper / Large	14500						
860617N	Massey Ferguson	Mähdrescher / 3400-9790	7250						
860617N	Massey Ferguson	Mähdrescher / 3400-9790	7252						
860617N	Massey Ferguson	Mähdrescher / 3400-9790	7254						
860617N	Massey Ferguson	Mähdrescher / 3400-9790	7256						
860617N	Massey Ferguson	Mähdrescher / 3400-9790	7256Cerea						
860617N	Massey Ferguson	Mähdrescher / 3400-9790	7260						
860617N	Massey Ferguson	Mähdrescher / 3400-9790	7265						
860617N	Massey Ferguson	Mähdrescher / 3400-9790	7272						
860617N	Massey Ferguson	Mähdrescher / 3400-9790	7274						
860617N	Massey Ferguson	Mähdrescher / 3400-9790	7276						
860617N	Massey Ferguson	Mähdrescher / 3400-9790	7278						
860617N	Massey Ferguson	Mähdrescher / 3400-9790	7282						
860097N	Massey Ferguson	Mähdrescher / MF 24-40	27						
860097N	Massey Ferguson	Mähdrescher / MF 24-40	29						
860097N	Massey Ferguson	Mähdrescher / MF 24-40	31						
860617N	Massey Ferguson	Mähdrescher / MF 24-40	34						
860617N	Massey Ferguson	Mähdrescher / MF 24-40	36						

Dasis Nr.	Hersteller	Modell	Typ	Spezifikation	Ausstattungsvariante	Anschlussgewinde	Eingangsdruck von [bar]	Ausgangsdruck von [bar]	Anzahl der Steckkontakte
860617N	Massey Ferguson	Mähdrescher / MF 24-40	38						
860617N	Massey Ferguson	Mähdrescher / MF 24-40	40						
860147N	Massey Ferguson	Schlepper / 300	340						
860147N	Massey Ferguson	Schlepper / 300	342						
860147N	Massey Ferguson	Schlepper / 300	350						
860147N	Massey Ferguson	Schlepper / 300	352						
860147N	Massey Ferguson	Schlepper / 300	353						
860147N	Massey Ferguson	Schlepper / 300	354						
860147N	Massey Ferguson	Schlepper / 300	355						
860147N	Massey Ferguson	Schlepper / 300	360						
860147N	Massey Ferguson	Schlepper / 300	362						
860147N	Massey Ferguson	Schlepper / 300	362N						
860147N	Massey Ferguson	Schlepper / 300	363						
860147N	Massey Ferguson	Schlepper / 300	365						
860147N	Massey Ferguson	Schlepper / 300	372						
860135N	Massey Ferguson	Schlepper / 300	373						
860192N	Massey Ferguson	Schlepper / 300	373						
860192N	Massey Ferguson	Schlepper / 300	373S						
860135N	Massey Ferguson	Schlepper / 300	373S						
860192N	Massey Ferguson	Schlepper / 300	374						
860135N	Massey Ferguson	Schlepper / 300	374						
860192N	Massey Ferguson	Schlepper / 300	374S						
860135N	Massey Ferguson	Schlepper / 300	374S						
860147N	Massey Ferguson	Schlepper / 300	375						
860147N	Massey Ferguson	Schlepper / 300	377						
860147N	Massey Ferguson	Schlepper / 300	382						
860192N	Massey Ferguson	Schlepper / 300	383						
860135N	Massey Ferguson	Schlepper / 300	383						
860192N	Massey Ferguson	Schlepper / 300	383S						
860135N	Massey Ferguson	Schlepper / 300	383S						
860192N	Massey Ferguson	Schlepper / 300	384						

Dasis Nr.	Hersteller	Modell	Typ	Spezifikation	Ausstattungsvariante	Anschlussgewinde	Eingangsdruck von [bar]	Ausgangsdruck von [bar]	Anzahl der Steckkontakte
860135N	Massey Ferguson	Schlepper / 300	384						
860192N	Massey Ferguson	Schlepper / 300	384F						
860147N	Massey Ferguson	Schlepper / 300	384S						
860147N	Massey Ferguson	Schlepper / 300	387						
860147N	Massey Ferguson	Schlepper / 300	390						
860147N	Massey Ferguson	Schlepper / 300	390T						
860192N	Massey Ferguson	Schlepper / 300	393						
860135N	Massey Ferguson	Schlepper / 300	393						
860192N	Massey Ferguson	Schlepper / 300	393S						
860135N	Massey Ferguson	Schlepper / 300	393S						
860192N	Massey Ferguson	Schlepper / 300	394						
860135N	Massey Ferguson	Schlepper / 300	394						
860192N	Massey Ferguson	Schlepper / 300	394F						
860135N	Massey Ferguson	Schlepper / 300	394F						
860135N	Massey Ferguson	Schlepper / 300	394S						
860192N	Massey Ferguson	Schlepper / 300	394S						
860147N	Massey Ferguson	Schlepper / 300	397						
860147N	Massey Ferguson	Schlepper / 300	398						
860147N	Massey Ferguson	Schlepper / 300	399						
860093N	Massey Ferguson	Schlepper / 2000	2620						
860093N	Massey Ferguson	Schlepper / 2000	2625						
860093N	Massey Ferguson	Schlepper / 2000	2640						
860093N	Massey Ferguson	Schlepper / 2000	2645						
860093N	Massey Ferguson	Schlepper / 2000	2675						
860093N	Massey Ferguson	Schlepper / 2000	2680						
860093N	Massey Ferguson	Schlepper / 2000	2685						
860093N	Massey Ferguson	Schlepper / 2000	2705						
860093N	Massey Ferguson	Schlepper / 2000	2720						
860093N	Massey Ferguson	Schlepper / 2000	2725						
860093N	Massey Ferguson	Schlepper / 2000	2775						
860093N	Massey Ferguson	Schlepper / 3000	3050						



Dasis Nr.	Hersteller	Modell	Typ	Spezifikation	Ausstattungsvariante	Anschlussgewinde	Eingangsdruck von [bar]	Ausgangsdruck von [bar]	Anzahl der Steckkontakte
750001N	Massey Ferguson	Schlepper / 3000	3050						
860092N	Massey Ferguson	Schlepper / 3000	3050			F			2
750001N	Massey Ferguson	Schlepper / 3000	3060						
860093N	Massey Ferguson	Schlepper / 3000	3060						
860092N	Massey Ferguson	Schlepper / 3000	3060			F			2
860093N	Massey Ferguson	Schlepper / 3000	3065						
750001N	Massey Ferguson	Schlepper / 3000	3065						
860092N	Massey Ferguson	Schlepper / 3000	3065			F			2
750001N	Massey Ferguson	Schlepper / 3000	3070						
860093N	Massey Ferguson	Schlepper / 3000	3070						
860092N	Massey Ferguson	Schlepper / 3000	3070			F			2
750001N	Massey Ferguson	Schlepper / 3000	3075						
860093N	Massey Ferguson	Schlepper / 3000	3075						
860092N	Massey Ferguson	Schlepper / 3000	3075			F			2
860093N	Massey Ferguson	Schlepper / 3000	3080						
750001N	Massey Ferguson	Schlepper / 3000	3080						
860092N	Massey Ferguson	Schlepper / 3000	3080			F			2
750001N	Massey Ferguson	Schlepper / 3000	3085						
860093N	Massey Ferguson	Schlepper / 3000	3085						
860092N	Massey Ferguson	Schlepper / 3000	3085			F			2
860093N	Massey Ferguson	Schlepper / 3000	3090						
750001N	Massey Ferguson	Schlepper / 3000	3090						
860092N	Massey Ferguson	Schlepper / 3000	3090			F			2
750001N	Massey Ferguson	Schlepper / 3000	3095						
860093N	Massey Ferguson	Schlepper / 3000	3095						
860092N	Massey Ferguson	Schlepper / 3000	3095			F			2
860093N	Massey Ferguson	Schlepper / 3000	3115						
750001N	Massey Ferguson	Schlepper / 3000	3115						
860092N	Massey Ferguson	Schlepper / 3000	3115			F			2
750001N	Massey Ferguson	Schlepper / 3000	3120						
860093N	Massey Ferguson	Schlepper / 3000	3120						

Dasis Nr.	Hersteller	Modell	Typ	Spezifikation	Ausstattungsvariante	Anschlussgewinde	Eingangsdruck von [bar]	Ausgangsdruck von [bar]	Anzahl der Steckkontakte
860092N	Massey Ferguson	Schlepper / 3000	3120			F			2
860093N	Massey Ferguson	Schlepper / 3000	3120T						
750001N	Massey Ferguson	Schlepper / 3000	3120T						
860092N	Massey Ferguson	Schlepper / 3000	3120T			F			2
750001N	Massey Ferguson	Schlepper / 3000	3125						
860093N	Massey Ferguson	Schlepper / 3000	3125						
860092N	Massey Ferguson	Schlepper / 3000	3125			F			2
750001N	Massey Ferguson	Schlepper / 3000	3140						
860093N	Massey Ferguson	Schlepper / 3000	3140						
860092N	Massey Ferguson	Schlepper / 3000	3140			F			2
750001N	Massey Ferguson	Schlepper / 3000	3610						
860093N	Massey Ferguson	Schlepper / 3000	3610						
860092N	Massey Ferguson	Schlepper / 3000	3610			F			2
860093N	Massey Ferguson	Schlepper / 3000	3630						
750001N	Massey Ferguson	Schlepper / 3000	3630						
860092N	Massey Ferguson	Schlepper / 3000	3630			F			2
860093N	Massey Ferguson	Schlepper / 3000	3635						
750001N	Massey Ferguson	Schlepper / 3000	3635						
860092N	Massey Ferguson	Schlepper / 3000	3635			F			2
860093N	Massey Ferguson	Schlepper / 3000	3645						
750001N	Massey Ferguson	Schlepper / 3000	3645						
860092N	Massey Ferguson	Schlepper / 3000	3645			F			2
750001N	Massey Ferguson	Schlepper / 3000	3650						
860093N	Massey Ferguson	Schlepper / 3000	3650						
860092N	Massey Ferguson	Schlepper / 3000	3650			F			2
750001N	Massey Ferguson	Schlepper / 3000	3655						
860093N	Massey Ferguson	Schlepper / 3000	3655						
860092N	Massey Ferguson	Schlepper / 3000	3655			F			2
750001N	Massey Ferguson	Schlepper / 3000	3660						
860093N	Massey Ferguson	Schlepper / 3000	3660						
860092N	Massey Ferguson	Schlepper / 3000	3660			F			2

Dasis Nr.	Hersteller	Modell	Typ	Spezifikation	Ausstattungsvariante	Anschlussgewinde	Eingangsdruck von [bar]	Ausgangsdruck von [bar]	Anzahl der Steckkontakte
750001N	Massey Ferguson	Schlepper / 3000	3670						
860093N	Massey Ferguson	Schlepper / 3000	3670						
860092N	Massey Ferguson	Schlepper / 3000	3670			F			2
750001N	Massey Ferguson	Schlepper / 3000	3680						
860093N	Massey Ferguson	Schlepper / 3000	3680						
860092N	Massey Ferguson	Schlepper / 3000	3680			F			2
860093N	Massey Ferguson	Schlepper / 3000	3690						
750001N	Massey Ferguson	Schlepper / 3000	3690						
860092N	Massey Ferguson	Schlepper / 3000	3690			F			2
860147N	Massey Ferguson	Schlepper / 4000	4215						
860147N	Massey Ferguson	Schlepper / 4000	4220						
860147N	Massey Ferguson	Schlepper / 4000	4225						
860147N	Massey Ferguson	Schlepper / 4000	4235						
860147N	Massey Ferguson	Schlepper / 4000	4240						
860147N	Massey Ferguson	Schlepper / 4000	4243						
860147N	Massey Ferguson	Schlepper / 4000	4245						
860147N	Massey Ferguson	Schlepper / 4000	4315						
860147N	Massey Ferguson	Schlepper / 4000	4320						
860147N	Massey Ferguson	Schlepper / 4000	4325						
860147N	Massey Ferguson	Schlepper / 4000	4335						
860147N	Massey Ferguson	Schlepper / 4000	4345						
860147N	Massey Ferguson	Schlepper / 4000	4355						
860147N	Massey Ferguson	Schlepper / 4000	4360						
860147N	Massey Ferguson	Schlepper / 4000	4370						
860092N	Massey Ferguson	Schlepper / 5000	5425			F			2
860092N	Massey Ferguson	Schlepper / 5000	5435			F			2
860092N	Massey Ferguson	Schlepper / 5000	5445			F			2
860092N	Massey Ferguson	Schlepper / 5000	5455			F			2
860092N	Massey Ferguson	Schlepper / 5000	5460			F			2
860092N	Massey Ferguson	Schlepper / 5000	5465			F			2
860092N	Massey Ferguson	Schlepper / 5000	5470			F			2

Dasis Nr.	Hersteller	Modell	Typ	Spezifikation	Ausstattungsvariante	Anschlussgewinde	Eingangsdruck von [bar]	Ausgangsdruck von [bar]	Anzahl der Steckkontakte
860092N	Massey Ferguson	Schlepper / 5000	5480			F			2
750001N	Massey Ferguson	Schlepper / 6000	6110						
860092N	Massey Ferguson	Schlepper / 6000	6110			F			2
750001N	Massey Ferguson	Schlepper / 6000	6120						
860092N	Massey Ferguson	Schlepper / 6000	6120			F			2
750001N	Massey Ferguson	Schlepper / 6000	6130						
860092N	Massey Ferguson	Schlepper / 6000	6130			F			2
750001N	Massey Ferguson	Schlepper / 6000	6140						
860092N	Massey Ferguson	Schlepper / 6000	6140			F			2
750001N	Massey Ferguson	Schlepper / 6000	6150						
860092N	Massey Ferguson	Schlepper / 6000	6150			F			2
750001N	Massey Ferguson	Schlepper / 6000	6160						
860092N	Massey Ferguson	Schlepper / 6000	6160			F			2
750001N	Massey Ferguson	Schlepper / 6000	6170						
860092N	Massey Ferguson	Schlepper / 6000	6170			F			2
750001N	Massey Ferguson	Schlepper / 6000	6180						
860092N	Massey Ferguson	Schlepper / 6000	6180			F			2
750001N	Massey Ferguson	Schlepper / 6000	6190						
860092N	Massey Ferguson	Schlepper / 6000	6190			F			2
750001N	Massey Ferguson	Schlepper / 6000	6235						
860092N	Massey Ferguson	Schlepper / 6000	6235			F			2
750001N	Massey Ferguson	Schlepper / 6000	6245						
860092N	Massey Ferguson	Schlepper / 6000	6245			F			2
750001N	Massey Ferguson	Schlepper / 6000	6255						
860092N	Massey Ferguson	Schlepper / 6000	6255			F			2
750001N	Massey Ferguson	Schlepper / 6000	6260						
860092N	Massey Ferguson	Schlepper / 6000	6260			F			2
750001N	Massey Ferguson	Schlepper / 6000	6265						
860092N	Massey Ferguson	Schlepper / 6000	6265			F			2
750001N	Massey Ferguson	Schlepper / 6000	6270						
860092N	Massey Ferguson	Schlepper / 6000	6270			F			2

Dasis Nr.	Hersteller	Modell	Typ	Spezifikation	Ausstattungsvariante	Anschlussgewinde	Eingangsdruck von [bar]	Ausgangsdruck von [bar]	Anzahl der Steckkontakte
750001N	Massey Ferguson	Schlepper / 6000	6280						
860092N	Massey Ferguson	Schlepper / 6000	6280			F			2
750001N	Massey Ferguson	Schlepper / 6000	6290						
860092N	Massey Ferguson	Schlepper / 6000	6290			F			2
860092N	Massey Ferguson	Schlepper / 6000	6445			F			2
860092N	Massey Ferguson	Schlepper / 6000	6455			F			2
860092N	Massey Ferguson	Schlepper / 6000	6460			F			2
860092N	Massey Ferguson	Schlepper / 6000	6465			F			2
860092N	Massey Ferguson	Schlepper / 6000	6470			F			2
860092N	Massey Ferguson	Schlepper / 6000	6475			F			2
860092N	Massey Ferguson	Schlepper / 6000	6480			F			2
860092N	Massey Ferguson	Schlepper / 6000	6485			F			2
860092N	Massey Ferguson	Schlepper / 6000	6490			F			2
860092N	Massey Ferguson	Schlepper / 6000	6495			F			2
860092N	Massey Ferguson	Schlepper / 6000	6497			F			2
860092N	Massey Ferguson	Schlepper / 6000	6499			F			2
860092N	Massey Ferguson	Schlepper / 7000	7465			F			2
860092N	Massey Ferguson	Schlepper / 7000	7475			F			2
860092N	Massey Ferguson	Schlepper / 7000	7480			F			2
860092N	Massey Ferguson	Schlepper / 7000	7485			F			2
860092N	Massey Ferguson	Schlepper / 7000	7490			F			2
860092N	Massey Ferguson	Schlepper / 7000	7495			F			2
860092N	Massey Ferguson	Schlepper / 7000	7495Räder3			F			2
750001N	Massey Ferguson	Schlepper / 8000	8110						
860092N	Massey Ferguson	Schlepper / 8000	8110			F			2
750001N	Massey Ferguson	Schlepper / 8000	8120						
860092N	Massey Ferguson	Schlepper / 8000	8120			F			2
750001N	Massey Ferguson	Schlepper / 8000	8130						
860092N	Massey Ferguson	Schlepper / 8000	8130			F			2
750001N	Massey Ferguson	Schlepper / 8000	8140						
860092N	Massey Ferguson	Schlepper / 8000	8140			F			2

Dasis Nr.	Hersteller	Modell	Typ	Spezifikation	Ausstattungsvariante	Anschlussgewinde	Eingangsdruck von [bar]	Ausgangsdruck von [bar]	Anzahl der Steckkontakte
750001N	Massey Ferguson	Schlepper / 8000	8150						
860092N	Massey Ferguson	Schlepper / 8000	8150			F			2
750001N	Massey Ferguson	Schlepper / 8000	8160						
860092N	Massey Ferguson	Schlepper / 8000	8160			F			2
750001N	Massey Ferguson	Schlepper / 8000	8170						
860092N	Massey Ferguson	Schlepper / 8000	8170			F			2
750001N	Massey Ferguson	Schlepper / 8000	8180						
860092N	Massey Ferguson	Schlepper / 8000	8180			F			2
750001N	Massey Ferguson	Schlepper / 8000	8210						
860092N	Massey Ferguson	Schlepper / 8000	8210			F			2
750001N	Massey Ferguson	Schlepper / 8000	8220						
860092N	Massey Ferguson	Schlepper / 8000	8220			F			2
750001N	Massey Ferguson	Schlepper / 8000	8240						
860092N	Massey Ferguson	Schlepper / 8000	8240			F			2
750001N	Massey Ferguson	Schlepper / 8000	8250						
860092N	Massey Ferguson	Schlepper / 8000	8250			F			2
750001N	Massey Ferguson	Schlepper / 8000	8260						
860092N	Massey Ferguson	Schlepper / 8000	8260			F			2
750001N	Massey Ferguson	Schlepper / 8000	8270						
860092N	Massey Ferguson	Schlepper / 8000	8270			F			2
750001N	Massey Ferguson	Schlepper / 8000	8280						
860092N	Massey Ferguson	Schlepper / 8000	8280			F			2
860128N	MC Cormick	Schlepper / CX	70						2
860131N	MC Cormick	Schlepper / CX	70						
860128N	MC Cormick	Schlepper / CX	80						2
860131N	MC Cormick	Schlepper / CX	80						
860131N	MC Cormick	Schlepper / CX	90						
860128N	MC Cormick	Schlepper / CX	90						2
860131N	MC Cormick	Schlepper / CX	100						
860128N	MC Cormick	Schlepper / CX	100						2
860131N	MC Cormick	Schlepper / MC	80						

Dasis Nr.	Hersteller	Modell	Typ	Spezifikation	Ausstattungsvariante	Anschlussgewinde	Eingangsdruck von [bar]	Ausgangsdruck von [bar]	Anzahl der Steckkontakte
860128N	MC Cormick	Schlepper / MC	80						2
860128N	MC Cormick	Schlepper / MC	90						2
860131N	MC Cormick	Schlepper / MC	90						
860131N	MC Cormick	Schlepper / MC	100						
860128N	MC Cormick	Schlepper / MC	100						2
860131N	MC Cormick	Schlepper / MC	115						
860128N	MC Cormick	Schlepper / MC	115						2
860131N	MC Cormick	Schlepper / MC	120						
860128N	MC Cormick	Schlepper / MC	120						2
860131N	MC Cormick	Schlepper / MC	135						
860128N	MC Cormick	Schlepper / MC	135						2
860128N	MC Cormick	Schlepper / MTX	110						2
860131N	MC Cormick	Schlepper / MTX	110						
860131N	MC Cormick	Schlepper / MTX	120						
860128N	MC Cormick	Schlepper / MTX	120						2
860128N	MC Cormick	Schlepper / MTX	125						2
860131N	MC Cormick	Schlepper / MTX	125						
860128N	MC Cormick	Schlepper / MTX	135						2
860131N	MC Cormick	Schlepper / MTX	135						
860128N	MC Cormick	Schlepper / MTX	140						2
860131N	MC Cormick	Schlepper / MTX	140						
860131N	MC Cormick	Schlepper / MTX	150						
860128N	MC Cormick	Schlepper / MTX	150						2
860131N	MC Cormick	Schlepper / MTX	155						
860128N	MC Cormick	Schlepper / MTX	155						2
860131N	MC Cormick	Schlepper / MTX	165						
860128N	MC Cormick	Schlepper / MTX	165						2
860128N	MC Cormick	Schlepper / MTX	175						2
860131N	MC Cormick	Schlepper / MTX	175						
860131N	MC Cormick	Schlepper / MTX	185						
860128N	MC Cormick	Schlepper / MTX	185						2

Dasis Nr.	Hersteller	Modell	Typ	Spezifikation	Ausstattungsvariante	Anschlussgewinde	Eingangsdruck von [bar]	Ausgangsdruck von [bar]	Anzahl der Steckkontakte
860128N	MC Cormick	Schlepper / XTX	185						2
860131N	MC Cormick	Schlepper / XTX	185						
860128N	MC Cormick	Schlepper / XTX	200						2
860131N	MC Cormick	Schlepper / XTX	200						
860131N	MC Cormick	Schlepper / XTX	215						
860128N	MC Cormick	Schlepper / XTX	215						2
860131N	MC Cormick	Schlepper / ZTX	230						
860128N	MC Cormick	Schlepper / ZTX	230						2
860131N	MC Cormick	Schlepper / ZTX	260						
860128N	MC Cormick	Schlepper / ZTX	260						2
860128N	MC Cormick	Schlepper / ZTX	280						2
860131N	MC Cormick	Schlepper / ZTX	280						
860050N	Merlo	Teleskoplader	KabineK						3
860616N	NEW HOLLAND	Schlepper / Boomer	45D						
860616N	NEW HOLLAND	Schlepper / Boomer	46D						
860616N	NEW HOLLAND	Schlepper / Boomer	54D						
860616N	NEW HOLLAND	Schlepper / Boomer	3040						
860616N	NEW HOLLAND	Schlepper / Boomer	3045						
860616N	NEW HOLLAND	Schlepper / Boomer	3050						
860143N	NEW HOLLAND	Schlepper / TG	215						2
860143N	NEW HOLLAND	Schlepper / TG	245						2
860143N	NEW HOLLAND	Schlepper / TG	275						2
860143N	NEW HOLLAND	Schlepper / TG	305						2
860149N	NEW HOLLAND	Schlepper / TL	70		3 Schaltstufen				
860149N	NEW HOLLAND	Schlepper / TL	80		3 Schaltstufen				
860149N	NEW HOLLAND	Schlepper / TL	90		3 Schaltstufen				
860149N	NEW HOLLAND	Schlepper / TL	100		3 Schaltstufen				
860133N	NEW HOLLAND	Schlepper / TM	TM115			F			4
860133N	NEW HOLLAND	Schlepper / TM	TM120			F			4
860133N	NEW HOLLAND	Schlepper / TM	TM125			F			4
860133N	NEW HOLLAND	Schlepper / TM	TM130			F			4



Dasis Nr.	Hersteller	Modell	Typ	Spezifikation	Ausstattungsvariante	Anschlussgewinde	Eingangsdruck von [bar]	Ausgangsdruck von [bar]	Anzahl der Steckkontakte
860133N	NEW HOLLAND	Schlepper / TM	TM135			F			4
860133N	NEW HOLLAND	Schlepper / TM	TM140			F			4
860133N	NEW HOLLAND	Schlepper / TM	TM150			F			4
860133N	NEW HOLLAND	Schlepper / TM	TM155			F			4
860133N	NEW HOLLAND	Schlepper / TM	TM165			F			4
860133N	NEW HOLLAND	Schlepper / TM	TM175			F			4
860133N	NEW HOLLAND	Schlepper / TM	TM190			F			4
860125N	Renault	Schlepper / Ares 500	540	Trinary		M			2
860125N	Renault	Schlepper / Ares 500	546	Trinary		M			2
860125N	Renault	Schlepper / Ares 500	550	Trinary		M			2
860125N	Renault	Schlepper / Ares 500	556	Trinary		M			2
860125N	Renault	Schlepper / Ares 500	560	Trinary		M			2
860125N	Renault	Schlepper / Ares 500	566	Trinary		M			2
860125N	Renault	Schlepper / Ares 600	610	Trinary		M			2
860125N	Renault	Schlepper / Ares 600	616	Trinary		M			2
860125N	Renault	Schlepper / Ares 600	620	Trinary		M			2
860125N	Renault	Schlepper / Ares 600	626	Trinary		M			2
860125N	Renault	Schlepper / Ares 600	630	Trinary		M			2
860125N	Renault	Schlepper / Ares 600	636	Trinary		M			2
860125N	Renault	Schlepper / Ares 600	640	Trinary		M			2
860125N	Renault	Schlepper / Ares 600	696	Trinary		M			2
860125N	Renault	Schlepper / Ares 700	710	Trinary		M			2
860125N	Renault	Schlepper / Ares 700	715	Trinary		M			2
860125N	Renault	Schlepper / Ares 700	720	Trinary		M			2
860125N	Renault	Schlepper / Ares 700	725	Trinary		M			2
860125N	Renault	Schlepper / Ares 700	735	Trinary		M			2
860125N	Renault	Schlepper / Ares 800	815	Trinary		M			2
860125N	Renault	Schlepper / Ares 800	816	Trinary		M			2
860125N	Renault	Schlepper / Ares 800	825	Trinary		M			2
860125N	Renault	Schlepper / Ares 800	826	Trinary		M			2
860125N	Renault	Schlepper / Ares 800	836	Trinary		M			2

Dasis Nr.	Hersteller	Modell	Typ	Spezifikation	Ausstattungsvariante	Anschlussgewinde	Eingangsdruck von [bar]	Ausgangsdruck von [bar]	Anzahl der Steckkontakte
860125N	Renault	Schlepper / Ceres	310	Trinary		M			2
860125N	Renault	Schlepper / Ceres	320	Trinary		M			2
860125N	Renault	Schlepper / Ceres	325	Trinary		M			2
860125N	Renault	Schlepper / Ceres	330	Trinary		M			2
860125N	Renault	Schlepper / Ceres	335	Trinary		M			2
860125N	Renault	Schlepper / Ceres	340	Trinary		M			2
860125N	Renault	Schlepper / Ceres	345	Trinary		M			2
860125N	Renault	Schlepper / Ceres	355	Trinary		M			2
860125N	Renault	Schlepper / Cergos	330	Trinary		M			2
860125N	Renault	Schlepper / Cergos	335	Trinary		M			2
860125N	Renault	Schlepper / Cergos	340	Trinary		M			2
860125N	Renault	Schlepper / Cergos	345	Trinary		M			2
860125N	Renault	Schlepper / Cergos	350	Trinary		M			2
860125N	Renault	Schlepper / Cergos	355	Trinary		M			2
750001N	Renault	Schlepper / M	421						
750001N	Renault	Schlepper / M	600						
750001N	Renault	Schlepper / M	650						
750001N	Renault	Schlepper / M	700						
750001N	Renault	Schlepper / M	704						
750001N	Renault	Schlepper / M	720						
750001N	Renault	Schlepper / M	724						
750001N	Renault	Schlepper / M	750						
750001N	Renault	Schlepper / M	754						
750001N	Renault	Schlepper / M	800						
750001N	Renault	Schlepper / M	804						
750001N	Renault	Schlepper / M	850						
750001N	Renault	Schlepper / M	854						
750001N	Renault	Schlepper / M	900						
750001N	Renault	Schlepper / M	940						
750001N	Renault	Schlepper / M	950						
750001N	Renault	Schlepper / M	954						

Dasis Nr.	Hersteller	Modell	Typ	Spezifikation	Ausstattungsvariante	Anschlussgewinde	Eingangsdruck von [bar]	Ausgangsdruck von [bar]	Anzahl der Steckkontakte
750001N	Renault	Schlepper / MI	650						
750001N	Renault	Schlepper / MI	750						
750001N	Renault	Schlepper / MI	754						
750001N	Renault	Schlepper / MI	850						
750001N	Renault	Schlepper / MI	854						
750001N	Renault	Schlepper / MI	900						
750001N	Renault	Schlepper / MI	904						
750001N	Renault	Schlepper / MI	950						
750001N	Renault	Schlepper / MI	954						
860129N	Same	Schlepper / Silver	80						
860129N	Same	Schlepper / Silver	85						
860129N	Same	Schlepper / Silver	90						
860129N	Same	Schlepper / Silver	95						
860129N	Same	Schlepper / Silver	100.4						
860129N	Same	Schlepper / Silver	100.6						
860129N	Same	Schlepper / Silver	105						
860129N	Same	Schlepper / Silver	110						
860129N	Same	Schlepper / Silver	115						
860129N	Same	Schlepper / Silver	130						
860129N	Same	Schlepper / Silver	160						
860129N	Same	Schlepper / Silver	180						
860133N	Steyr	Forstmaschine	SonstigeModelle			F			4
860136N	Steyr	Schlepper / CS	78	Binary		F	15	12	1
860136N	Steyr	Schlepper / CS	86	Binary		F	15	12	1
860136N	Steyr	Schlepper / CS	94	Binary		F	15	12	1
860136N	Steyr	Schlepper / CS	100	Binary		F	15	12	1
860136N	Steyr	Schlepper / CS	110	Binary		F	15	12	1
860136N	Steyr	Schlepper / CS	120	Binary		F	15	12	1
860136N	Steyr	Schlepper / CS	130	Binary		F	15	12	1
860136N	Steyr	Schlepper / CS	150	Binary		F	15	12	1

Dasis Nr.	Hersteller	Modell	Typ	Ausstattungsvariante	Spannung [V]	Drehrichtung
740834N	Case International IHC	Schlepper / 186-996	766	Schaft D mm 9,5 Schaftlaenge 103	12	Drehrichtung gegen den Uhrzeigersinn
740831N	Case International IHC	Schlepper / 186-996	766	Schaft D mm 8 Schaftlaenge 38	12	
740831N	Case International IHC	Schlepper / 186-996	966	Schaft D mm 8 Schaftlaenge 38	12	
740834N	Case International IHC	Schlepper / 186-996	966	Schaft D mm 9,5 Schaftlaenge 103	12	Drehrichtung gegen den Uhrzeigersinn
740834N	Case International IHC	Schlepper / 186-996	Hydro 186	Schaft D mm 9,5 Schaftlaenge 103	12	Drehrichtung gegen den Uhrzeigersinn
740831N	Case International IHC	Schlepper / 1046-1896	1066	Schaft D mm 8 Schaftlaenge 38	12	
740834N	Case International IHC	Schlepper / 1046-1896	1066	Schaft D mm 9,5 Schaftlaenge 103	12	Drehrichtung gegen den Uhrzeigersinn
740831N	Case International IHC	Schlepper / 1046-1896	1466	Schaft D mm 8 Schaftlaenge 38	12	
740834N	Case International IHC	Schlepper / 1046-1896	1466	Schaft D mm 9,5 Schaftlaenge 103	12	Drehrichtung gegen den Uhrzeigersinn
740831N	Case International IHC	Schlepper / 1046-1896	1566	Schaft D mm 8 Schaftlaenge 38	12	
740834N	Case International IHC	Schlepper / 1046-1896	1566	Schaft D mm 9,5 Schaftlaenge 103	12	Drehrichtung gegen den Uhrzeigersinn
740834N	Case International IHC	Schlepper / 3088-3788	3088	Schaft D mm 9,5 Schaftlaenge 103	12	Drehrichtung gegen den Uhrzeigersinn
740834N	Case International IHC	Schlepper / 3088-3788	3288	Schaft D mm 9,5 Schaftlaenge 103	12	Drehrichtung gegen den Uhrzeigersinn
740834N	Case International IHC	Schlepper / 3088-3788	3388	Schaft D mm 9,5 Schaftlaenge 103	12	Drehrichtung gegen den Uhrzeigersinn
740834N	Case International IHC	Schlepper / 3088-3788	3488	Schaft D mm 9,5 Schaftlaenge 103	12	Drehrichtung gegen den Uhrzeigersinn
740834N	Case International IHC	Schlepper / 3088-3788	3588	Schaft D mm 9,5 Schaftlaenge 103	12	Drehrichtung gegen den Uhrzeigersinn
740834N	Case International IHC	Schlepper / 3088-3788	3688	Schaft D mm 9,5 Schaftlaenge 103	12	Drehrichtung gegen den Uhrzeigersinn
740834N	Case International IHC	Schlepper / 3088-3788	3788	Schaft D mm 9,5 Schaftlaenge 103	12	Drehrichtung gegen den Uhrzeigersinn
740834N	Case International IHC	Schlepper / 4000-4894	4186	Schaft D mm 9,5 Schaftlaenge 103	12	Drehrichtung gegen den Uhrzeigersinn
740834N	Case International IHC	Schlepper / 4000-4894	4386	Schaft D mm 9,5 Schaftlaenge 103	12	Drehrichtung gegen den Uhrzeigersinn
740834N	Case International IHC	Schlepper / 4000-4894	4490	Schaft D mm 9,5 Schaftlaenge 103	12	Drehrichtung gegen den Uhrzeigersinn
740834N	Case International IHC	Schlepper / 4000-4894	4494	Schaft D mm 9,5 Schaftlaenge 103	12	Drehrichtung gegen den Uhrzeigersinn
740834N	Case International IHC	Schlepper / 4000-4894	4586	Schaft D mm 9,5 Schaftlaenge 103	12	Drehrichtung gegen den Uhrzeigersinn

Dasis Nr.	Hersteller	Modell	Typ	Ausstattungsvariante	Spannung [V]	Drehrichtung
740834N	Case International IHC	Schlepper / 4000-4894	4690	Schaft D mm 9,5 Schaftlaenge 103	12	Drehrichtung gegen den Uhrzeigersinn
740834N	Case International IHC	Schlepper / 4000-4894	4694	Schaft D mm 9,5 Schaftlaenge 103	12	Drehrichtung gegen den Uhrzeigersinn
740834N	Case International IHC	Schlepper / 4000-4894	4786	Schaft D mm 9,5 Schaftlaenge 103	12	Drehrichtung gegen den Uhrzeigersinn
740834N	Case International IHC	Schlepper / 4000-4894	4890	Schaft D mm 9,5 Schaftlaenge 103	12	Drehrichtung gegen den Uhrzeigersinn
740834N	Case International IHC	Schlepper / 4000-4894	4894	Schaft D mm 9,5 Schaftlaenge 103	12	Drehrichtung gegen den Uhrzeigersinn
740834N	Case International IHC	Schlepper / 5088-5488	5088	Schaft D mm 9,5 Schaftlaenge 103	12	Drehrichtung gegen den Uhrzeigersinn
740834N	Case International IHC	Schlepper / 5088-5488	5288	Schaft D mm 9,5 Schaftlaenge 103	12	Drehrichtung gegen den Uhrzeigersinn
740834N	Case International IHC	Schlepper / 5088-5488	5488	Schaft D mm 9,5 Schaftlaenge 103	12	Drehrichtung gegen den Uhrzeigersinn
740834N	Case International IHC	Schlepper / 6388-6788	6388	Schaft D mm 9,5 Schaftlaenge 103	12	Drehrichtung gegen den Uhrzeigersinn
740834N	Case International IHC	Schlepper / 6388-6788	6588	Schaft D mm 9,5 Schaftlaenge 103	12	Drehrichtung gegen den Uhrzeigersinn
740834N	Case International IHC	Schlepper / 6388-6788	6788	Schaft D mm 9,5 Schaftlaenge 103	12	Drehrichtung gegen den Uhrzeigersinn
740834N	Case International IHC	Schlepper / 7110-7488	7288	Schaft D mm 9,5 Schaftlaenge 103	12	Drehrichtung gegen den Uhrzeigersinn
740834N	Case International IHC	Schlepper / 7110-7488	7488	Schaft D mm 9,5 Schaftlaenge 103	12	Drehrichtung gegen den Uhrzeigersinn
740832N	Case International IHC	Schlepper / 8910-8950	8910	Schaft D mm 8 Schaftlaenge 62	12	
740832N	Case International IHC	Schlepper / 8910-8950	8920	Schaft D mm 8 Schaftlaenge 62	12	
740832N	Case International IHC	Schlepper / 8910-8950	8930	Schaft D mm 8 Schaftlaenge 62	12	
740832N	Case International IHC	Schlepper / 8910-8950	8940	Schaft D mm 8 Schaftlaenge 62	12	
740832N	Case International IHC	Schlepper / 8910-8950	8950	Schaft D mm 8 Schaftlaenge 62	12	
740834N	Case International IHC	Schlepper / PJV Hydro	100	Schaft D mm 9,5 Schaftlaenge 103	12	Drehrichtung gegen den Uhrzeigersinn
740834N	Case International IHC	Schlepper / PJV Hydro	186	Schaft D mm 9,5 Schaftlaenge 103	12	Drehrichtung gegen den Uhrzeigersinn
740831N	Caterpillar	Baggerlader / 400	416	Schaft D mm 8 Schaftlaenge 38	12	
740831N	Caterpillar	Baggerlader / 400B	416	Schaft D mm 8 Schaftlaenge 38	12	
740831N	Caterpillar	Baggerlader / 400C	436	Schaft D mm 8 Schaftlaenge 38	12	
740043N	Caterpillar	Raupen Dozer / 900	941B			
740045N	Caterpillar	Raupen Dozer / 900	941B	Schaft D mm 8	24	Drehrichtung gegen den Uhrzeigersinn

Dasis Nr.	Hersteller	Modell	Typ	Ausstattungsvariante	Spannung [V]	Drehrichtung
740043N	Caterpillar	Raupen Dozer / 900	951			
740045N	Caterpillar	Raupen Dozer / 900	951	Schaft D mm 8	24	Drehrichtung gegen den Uhrzeigersinn
740043N	Caterpillar	Raupen Dozer / 900	955L			
740045N	Caterpillar	Raupen Dozer / 900	955L	Schaft D mm 8	24	Drehrichtung gegen den Uhrzeigersinn
740043N	Caterpillar	Raupen Dozer / D	4			
740043N	Caterpillar	Raupen Dozer / D	4E			
740085N	Caterpillar	Raupen Dozer / D	4E	Schaft D mm 8	24	
740043N	Caterpillar	Raupen Dozer / D	5B			
740085N	Caterpillar	Raupen Dozer / D	5B	Schaft D mm 8	24	
740043N	Caterpillar	Raupen Dozer / D	5H			
740085N	Caterpillar	Raupen Dozer / D	6	Schaft D mm 8	24	
740085N	Caterpillar	Raupen Dozer / D	8	Schaft D mm 8	24	
740085N	Caterpillar	Raupen Dozer / D	8H	Schaft D mm 8	24	
740085N	Caterpillar	Raupen Dozer / D	10	Schaft D mm 8	24	
740045N	Caterpillar	Schaufellader / 900	920	Schaft D mm 8	24	Drehrichtung gegen den Uhrzeigersinn
740043N	Caterpillar	Schaufellader / 900	930G			
740045N	Caterpillar	Schaufellader / 900	930G	Schaft D mm 8	24	Drehrichtung gegen den Uhrzeigersinn
740045N	Caterpillar	Walzenzüge / Landfill	825C	Schaft D mm 8	24	Drehrichtung gegen den Uhrzeigersinn
740832N	Claas	Feldhäcksler / Jaguar	685	Schaft D mm 8 Schaftlaenge 62	12	
740831N	Claas	Feldhäcksler / Jaguar	685	Schaft D mm 8 Schaftlaenge 38	12	
740832N	Claas	Feldhäcksler / Jaguar	690	Schaft D mm 8 Schaftlaenge 62	12	
740831N	Claas	Feldhäcksler / Jaguar	690	Schaft D mm 8 Schaftlaenge 38	12	
740832N	Claas	Feldhäcksler / Jaguar	695	Schaft D mm 8 Schaftlaenge 62	12	
740831N	Claas	Feldhäcksler / Jaguar	695	Schaft D mm 8 Schaftlaenge 38	12	
740831N	Claas	Feldhäcksler / Jaguar	860	Schaft D mm 8 Schaftlaenge 38	12	
740832N	Claas	Feldhäcksler / Jaguar	860	Schaft D mm 8 Schaftlaenge 62	12	
740831N	Claas	Feldhäcksler / Jaguar	880	Schaft D mm 8 Schaftlaenge 38	12	
740832N	Claas	Feldhäcksler / Jaguar	880	Schaft D mm 8 Schaftlaenge 62	12	
740831N	Claas	Mähdrescher / Dominator 6	56	Schaft D mm 8 Schaftlaenge 38	12	
740831N	Claas	Mähdrescher / Dominator 6	66	Schaft D mm 8 Schaftlaenge 38	12	

Dasis Nr.	Hersteller	Modell	Typ	Ausstattungsvariante	Spannung [V]	Drehrichtung
740831N	Claas	Mähdrescher / Dominator 6	76	Schaft D mm 8 Schaftlaenge 38	12	
740831N	Claas	Mähdrescher / Dominator 6	86	Schaft D mm 8 Schaftlaenge 38	12	
740831N	Claas	Mähdrescher / Dominator 6	96	Schaft D mm 8 Schaftlaenge 38	12	
740831N	Claas	Mähdrescher / Dominator 6	106	Schaft D mm 8 Schaftlaenge 38	12	
740831N	Claas	Mähdrescher / Dominator 6	116	Schaft D mm 8 Schaftlaenge 38	12	
740832N	Claas	Mähdrescher / Dominator 8	98	Schaft D mm 8 Schaftlaenge 62	12	
740831N	Claas	Mähdrescher / Dominator 8	98	Schaft D mm 8 Schaftlaenge 38	12	
448179N	Deutz	Schlepper / DO7	4007			
448179N	Deutz	Schlepper / DO7	4507			
448179N	Deutz	Schlepper / DO7	4807			
448179N	Deutz	Schlepper / DO7	5207			
448179N	Deutz	Schlepper / DO7	6007			
448179N	Deutz	Schlepper / DO7	6207			
448179N	Deutz	Schlepper / DO7	6507			
448179N	Deutz	Schlepper / DO7	6807			
448179N	Deutz	Schlepper / DO7	6907			
448179N	Deutz	Schlepper / DO7	7007			
448179N	Deutz	Schlepper / DO7	7207			
448179N	Deutz	Schlepper / DO7	7807			
448179N	Deutz	Schlepper / DO7C	4507			
448179N	Deutz	Schlepper / DO7C	4807			
448179N	Deutz	Schlepper / DO7C	5207			
448179N	Deutz	Schlepper / DO7C	6007			
448179N	Deutz	Schlepper / DO7C	6207			
448179N	Deutz	Schlepper / DO7C	6507			
448179N	Deutz	Schlepper / DO7C	6807			
448179N	Deutz	Schlepper / DO7C	6907			
448179N	Deutz	Schlepper / DO7C	7007			
448179N	Deutz	Schlepper / DO7C	7207			
448179N	Deutz	Schlepper / DO7C	7807			
448179N	Deutz	Schlepper / DX	3.10			
448179N	Deutz	Schlepper / DX	3.30			

Dasis Nr.	Hersteller	Modell	Typ	Ausstattungsvariante	Spannung [V]	Drehrichtung
448179N	Deutz	Schlepper / DX	3.50			
448179N	Deutz	Schlepper / DX	3.60			
448179N	Deutz	Schlepper / DX	3.70			
448179N	Deutz	Schlepper / DX	3.80			
448179N	Deutz	Schlepper / DX	3.90			
448179N	Deutz	Schlepper / DX	4.10			
448179N	Deutz	Schlepper / DX	4.30			
448179N	Deutz	Schlepper / DX	4.50			
448179N	Deutz	Schlepper / DX	4.70			
448179N	Deutz	Schlepper / DX	6.05			
448179N	Deutz	Schlepper / DX	6.10			
448179N	Deutz	Schlepper / DX	6.30			
448179N	Deutz	Schlepper / DX	6.50			
448179N	Deutz	Schlepper / DX	80			
448179N	Deutz	Schlepper / DX	85			
448179N	Deutz	Schlepper / DX	86			
448179N	Deutz	Schlepper / DX	90			
448179N	Deutz	Schlepper / DX	92			
448179N	Deutz	Schlepper / DX	110			
448179N	Deutz	Schlepper / DX	120			
448179N	Deutz	Schlepper / DX	140			
448179N	Deutz	Schlepper / DX	145			
448179N	Deutz	Schlepper / DX	160			
448179N	Deutz	Schlepper / DX	180			
448179N	Deutz	Schlepper / DX	230			
448179N	Deutz	Schlepper / DX	250			
448178N	Fendt	Schlepper / Farmer 300	303LS			
448177N	Fendt	Schlepper / Farmer 300	303LS			
448178N	Fendt	Schlepper / Farmer 300	303LSA			
448177N	Fendt	Schlepper / Farmer 300	303LSA			
448177N	Fendt	Schlepper / Farmer 300	304			
448178N	Fendt	Schlepper / Farmer 300	304			



Dasis Nr.	Hersteller	Modell	Typ	Ausstattungsvariante	Spannung [V]	Drehrichtung
448177N	Fendt	Schlepper / Farmer 300	304LS			
448178N	Fendt	Schlepper / Farmer 300	304LS			
448178N	Fendt	Schlepper / Farmer 300	304LSA			
448177N	Fendt	Schlepper / Farmer 300	304LSA			
448178N	Fendt	Schlepper / Farmer 300	305			
448177N	Fendt	Schlepper / Farmer 300	305			
448178N	Fendt	Schlepper / Farmer 300	306			
448177N	Fendt	Schlepper / Farmer 300	306			
448177N	Fendt	Schlepper / Farmer 300	307LS			
448178N	Fendt	Schlepper / Farmer 300	307LS			
448177N	Fendt	Schlepper / Farmer 300	307LSA			
448178N	Fendt	Schlepper / Farmer 300	307LSA			
448177N	Fendt	Schlepper / Farmer 300	307LSE			
448178N	Fendt	Schlepper / Farmer 300	307LSE			
448177N	Fendt	Schlepper / Farmer 300	308			
448178N	Fendt	Schlepper / Farmer 300	308			
448177N	Fendt	Schlepper / Farmer 300	308LS			
448178N	Fendt	Schlepper / Farmer 300	308LS			
448178N	Fendt	Schlepper / Farmer 300	308LSA			
448177N	Fendt	Schlepper / Farmer 300	308LSA			
448177N	Fendt	Schlepper / Farmer 300	308LSE			
448178N	Fendt	Schlepper / Farmer 300	308LSE			
448177N	Fendt	Schlepper / Farmer 300	309			
448178N	Fendt	Schlepper / Farmer 300	309			
448178N	Fendt	Schlepper / Farmer 300	309LS			
448177N	Fendt	Schlepper / Farmer 300	309LS			
448177N	Fendt	Schlepper / Farmer 300	309LSA			
448178N	Fendt	Schlepper / Farmer 300	309LSA			
448177N	Fendt	Schlepper / Farmer 300	309LSE			
448178N	Fendt	Schlepper / Farmer 300	309LSE			
448177N	Fendt	Schlepper / Farmer 300	310			
448178N	Fendt	Schlepper / Farmer 300	310			

Dasis Nr.	Hersteller	Modell	Typ	Ausstattungsvariante	Spannung [V]	Drehrichtung
448177N	Fendt	Schlepper / Farmer 300	310LSA			
448178N	Fendt	Schlepper / Farmer 300	310LSA			
448177N	Fendt	Schlepper / Farmer 300	310LSE			
448178N	Fendt	Schlepper / Farmer 300	310LSE			
448177N	Fendt	Schlepper / Farmer 300	311			
448178N	Fendt	Schlepper / Farmer 300	311			
448177N	Fendt	Schlepper / Farmer 300	311LSA			
448178N	Fendt	Schlepper / Farmer 300	311LSA			
448178N	Fendt	Schlepper / Farmer 300	311LSE			
448177N	Fendt	Schlepper / Farmer 300	311LSE			
448178N	Fendt	Schlepper / Farmer 300	312			
448177N	Fendt	Schlepper / Farmer 300	312			
448178N	Fendt	Schlepper / Farmer 300	312LSA			
448177N	Fendt	Schlepper / Farmer 300	312LSA			
448178N	Fendt	Schlepper / Farmer 300	312LSE			
448177N	Fendt	Schlepper / Farmer 300	312LSE			
448178N	Fendt	Schlepper / Favorit 500	509			
448177N	Fendt	Schlepper / Favorit 500	509			
448178N	Fendt	Schlepper / Favorit 500	510			
448177N	Fendt	Schlepper / Favorit 500	510			
448178N	Fendt	Schlepper / Favorit 500	511			
448177N	Fendt	Schlepper / Favorit 500	511			
448177N	Fendt	Schlepper / Favorit 500	512			
448178N	Fendt	Schlepper / Favorit 500	512			
448177N	Fendt	Schlepper / Favorit 500	514			
448178N	Fendt	Schlepper / Favorit 500	514			
740170N	Fendt	Schlepper / Vario	819			
740170N	Fendt	Schlepper / Vario	822			
740170N	Fendt	Schlepper / Vario	824			
740170N	Fendt	Schlepper / Vario	826			
740170N	Fendt	Schlepper / Vario	828			
740170N	Fendt	Schlepper / Vario	922			

Dasis Nr.	Hersteller	Modell	Typ	Ausstattungsvariante	Spannung [V]	Drehrichtung
740170N	Fendt	Schlepper / Vario	924			
740170N	Fendt	Schlepper / Vario	927			
740170N	Fendt	Schlepper / Vario	930			
740170N	Fendt	Schlepper / Vario	933			
740170N	Fendt	Schlepper / Vario	936			
740170N	Fendt	Schlepper / Vario	939			
448180N	Fiat / Hitachi	Kabine CS	11			
448180N	Fiat / Hitachi	Kabine CS	12			
448180N	Fiat / Hitachi	Kabine CS	13			
448180N	Fiat / Hitachi	Kabine CS	14			
448180N	Fiat / Hitachi	Kabine CS	17			
448180N	Fiat / Hitachi	Kabine CS	19			
448180N	Fiat / Hitachi	Kabine CS	22			
448180N	Fiat / Hitachi	Kabine CS	23			
448180N	Fiat / Hitachi	Kabine TS	24			
448180N	Fiat / Hitachi	Kabine TS	25			
448180N	Fiat / Hitachi	Schlepper	45-66			
448180N	Fiat / Hitachi	Schlepper	55-66			
448180N	Fiat / Hitachi	Schlepper	55-88			
448180N	Fiat / Hitachi	Schlepper	56-66S			
448180N	Fiat / Hitachi	Schlepper	60-88			
448180N	Fiat / Hitachi	Schlepper	65-88			
448180N	Fiat / Hitachi	Schlepper	70-88			
448180N	Fiat / Hitachi	Schlepper	80-88			
448180N	Fiat / Hitachi	Schlepper	580			
448180N	Fiat / Hitachi	Schlepper	680			
448180N	Fiat / Hitachi	Schlepper	780			
448180N	Fiat / Hitachi	Schlepper	880			
448180N	Fiat / Hitachi	Schlepper	980			
448180N	Fiat / Hitachi	Schlepper ....-90	55-90			
448180N	Fiat / Hitachi	Schlepper ....-90	60-90			
448180N	Fiat / Hitachi	Schlepper ....-90	60-90DT			

Dasis Nr.	Hersteller	Modell	Typ	Ausstattungsvariante	Spannung [V]	Drehrichtung
448180N	Fiat / Hitachi	Schlepper ....-90	65-90			
448180N	Fiat / Hitachi	Schlepper ....-90	65-90DT			
448180N	Fiat / Hitachi	Schlepper ....-90	90-90DT			
448180N	Fiat / Hitachi	Schlepper ....-90	95-90DT			
448180N	Fiat / Hitachi	Schlepper ....-90	100-90DT			
448180N	Fiat / Hitachi	Schlepper ....-90	110-90DT			
448180N	Fiat / Hitachi	Schlepper ....-90	115-90DT			
448180N	Fiat / Hitachi	Schlepper ....-90	130-90DT			
448180N	Fiat / Hitachi	Schlepper ....-90	140-90DT			
448180N	Fiat / Hitachi	Schlepper ....-90	180-90DT			
741960N	JCB	Bagger 360 ° / 800	802		12	
741960N	JCB	Bagger 360 ° / 800	803		12	
741960N	JCB	Bagger 360 ° / 800	804		12	
741960N	JCB	Bagger 360° / 8000	8052		12	
741960N	JCB	Bagger 360° / 8000	8056		12	
741960N	JCB	Bagger 360° / 8000	8060		12	
741960N	JCB	Teleskoplader / 500 Serie	526-58		12	
741960N	JCB	Teleskoplader / 500 Serie	526-67		12	
741960N	JCB	Teleskoplader / 500 Serie	527-58		12	
741960N	JCB	Teleskoplader / 500 Serie	527-67		12	
741960N	JCB	Teleskoplader / 500 Serie	530-67		12	
741960N	JCB	Teleskoplader / 500 Serie	530-95		12	
741960N	JCB	Teleskoplader / 500 Serie	530-110		12	
741960N	JCB	Teleskoplader / 500 Serie	530-120		12	
741960N	JCB	Teleskoplader / 500 Serie	537-120		12	
741960N	JCB	Teleskoplader / 500 Serie	537-130		12	
740834N	John Deere	Mähdrescher / 900-1188	955	Schaft D mm 9,5 Schaftlaenge 103	12	Drehrichtung gegen den Uhrzeigersinn
740834N	John Deere	Mähdrescher / 900-1188	965	Schaft D mm 9,5 Schaftlaenge 103	12	Drehrichtung gegen den Uhrzeigersinn
740834N	John Deere	Mähdrescher / 900-1188	975	Schaft D mm 9,5 Schaftlaenge 103	12	Drehrichtung gegen den Uhrzeigersinn
740834N	John Deere	Mähdrescher / 900-1188	985	Schaft D mm 9,5 Schaftlaenge 103	12	Drehrichtung gegen den Uhrzeigersinn

Dasis Nr.	Hersteller	Modell	Typ	Ausstattungsvariante	Spannung [V]	Drehrichtung
740022N	John Deere	Schlepper / 300-955	830	Schaft D mm 8 Schaftlaenge 70	12	Drehrichtung im Uhrzeigersinn
740022N	John Deere	Schlepper / 300-955	930	Schaft D mm 8 Schaftlaenge 70	12	Drehrichtung im Uhrzeigersinn
740022N	John Deere	Schlepper / 1000-1950	1030	Schaft D mm 8 Schaftlaenge 70	12	Drehrichtung im Uhrzeigersinn
740022N	John Deere	Schlepper / 1000-1950	1130	Schaft D mm 8 Schaftlaenge 70	12	Drehrichtung im Uhrzeigersinn
740022N	John Deere	Schlepper / 1000-1950	1530	Schaft D mm 8 Schaftlaenge 70	12	Drehrichtung im Uhrzeigersinn
740022N	John Deere	Schlepper / 1000-1950	1630	Schaft D mm 8 Schaftlaenge 70	12	Drehrichtung im Uhrzeigersinn
740022N	John Deere	Schlepper / 1000-1950	1830	Schaft D mm 8 Schaftlaenge 70	12	Drehrichtung im Uhrzeigersinn
740022N	John Deere	Schlepper / 2000-2955	2030	Schaft D mm 8 Schaftlaenge 70	12	Drehrichtung im Uhrzeigersinn
740022N	John Deere	Schlepper / 2000-2955	2130	Schaft D mm 8 Schaftlaenge 70	12	Drehrichtung im Uhrzeigersinn
740022N	John Deere	Schlepper / 3000-3650	3030	Schaft D mm 8 Schaftlaenge 70	12	Drehrichtung im Uhrzeigersinn
740022N	John Deere	Schlepper / 3000-3650	3130	Schaft D mm 8 Schaftlaenge 70	12	Drehrichtung im Uhrzeigersinn
740022N	John Deere	Schlepper / 4000-4955	4230	Schaft D mm 8 Schaftlaenge 70	12	Drehrichtung im Uhrzeigersinn
740022N	John Deere	Schlepper / 4000-4955	4430	Schaft D mm 8 Schaftlaenge 70	12	Drehrichtung im Uhrzeigersinn
740022N	John Deere	Schlepper / 4000-4955	4630	Schaft D mm 8 Schaftlaenge 70	12	Drehrichtung im Uhrzeigersinn
740022N	John Deere	Schlepper / 8000-8640	8430	Schaft D mm 8 Schaftlaenge 70	12	Drehrichtung im Uhrzeigersinn
740043N	Komatsu	Bagger 360 Grad / PC	60-1000			
740127N	Komatsu	Bagger 360 Grad / PC	60-1000	Schaft D mm 8 Schaftlaenge 51	24	Drehrichtung im Uhrzeigersinn
741951N	Komatsu	Bagger 360 Grad / PC	1250-7			
741951N	Komatsu	Bagger 360 Grad / PC	1250LC-7			
741951N	Komatsu	Bagger 360 Grad / PC	1250SP-7			
741951N	Komatsu	Raupen Dozer / D	41-P6			
741951N	Komatsu	Raupen Dozer / D	41E-6			
741951N	Komatsu	Raupen Dozer / D	60P-12-E			
741951N	Komatsu	Raupen Dozer / D	61E-12			
741951N	Komatsu	Raupen Dozer / D	61EX-12			
741951N	Komatsu	Raupen Dozer / D	61EX-15			
741951N	Komatsu	Raupen Dozer / D	61P-12			
741951N	Komatsu	Raupen Dozer / D	61PX-12			
741951N	Komatsu	Raupen Dozer / D	61PX-15			
741951N	Komatsu	Raupen Dozer / D	65EX-12			
741951N	Komatsu	Raupen Dozer / D	65EX-15			
741951N	Komatsu	Raupen Dozer / D	65EX-15E0			

Dasis Nr.	Hersteller	Modell	Typ	Ausstattungsvariante	Spannung [V]	Drehrichtung
741951N	Komatsu	Raupen Dozer / D	65PX-15E0			
741951N	Komatsu	Raupen Dozer / D	65WX-15			
741951N	Komatsu	Raupen Dozer / D	85EX-15R			
741951N	Komatsu	Raupen Dozer / D	85PX-15R			
740043N	Komatsu	Raupen Dozer / D	155-1			
740831N	Komatsu	Raupen Dozer / D	155-1	Schaft D mm 8 Schaftlaenge 38	12	
740022N	Komatsu	Raupen Dozer / D	155-1	Schaft D mm 8 Schaftlaenge 70	12	Drehrichtung im Uhrzeigersinn
740127N	Komatsu	Raupen Dozer / D	155-1	Schaft D mm 8 Schaftlaenge 51	24	Drehrichtung im Uhrzeigersinn
741951N	Komatsu	Raupen Dozer / D	155A-3C			
741951N	Komatsu	Raupen Dozer / D	155AX-5			
741951N	Komatsu	Raupen Dozer / D	275A-5R			
740043N	Komatsu	Raupen Dozer / D	355A-3			
740022N	Komatsu	Raupen Dozer / D	355A-3	Schaft D mm 8 Schaftlaenge 70	12	Drehrichtung im Uhrzeigersinn
740831N	Komatsu	Raupen Dozer / D	355A-3	Schaft D mm 8 Schaftlaenge 38	12	
740127N	Komatsu	Raupen Dozer / D	355A-3	Schaft D mm 8 Schaftlaenge 51	24	Drehrichtung im Uhrzeigersinn
741951N	Komatsu	Raupen Dozer / D	375A-3			
741951N	Komatsu	Raupen Dozer / D	375A-3-01			
741951N	Komatsu	Raupen Dozer / D	375A-6			
741951N	Komatsu	Raupen Dozer / D	375A-6R			
741951N	Komatsu	Raupen Dozer / D	475A-3			
740043N	Komatsu	Schaufellader / WA	350-650			
740127N	Komatsu	Schaufellader / WA	350-650	Schaft D mm 8 Schaftlaenge 51	24	Drehrichtung im Uhrzeigersinn
740045N	Liebherr	Schlepper	SonstigeModelle	Schaft D mm 8	24	Drehrichtung gegen den Uhrzeigersinn
740043N	Liebherr	Teleskoplader	Sonstige			
740201N	Massey Ferguson	Mähdrescher / 10-900	740			
740201N	Massey Ferguson	Mähdrescher / 10-900	750			
740201N	Massey Ferguson	Mähdrescher / 10-900	760			
740834N	Massey Ferguson	Mähdrescher / 10-900	800	Schaft D mm 9,5 Schaftlaenge 103	12	Drehrichtung gegen den Uhrzeigersinn
740834N	Massey Ferguson	Mähdrescher / 10-900	805	Schaft D mm 9,5 Schaftlaenge 103	12	Drehrichtung gegen den Uhrzeigersinn
740834N	Massey Ferguson	Mähdrescher / 10-900	810	Schaft D mm 9,5 Schaftlaenge 103	12	Drehrichtung gegen den Uhrzeigersinn

Dasis Nr.	Hersteller	Modell	Typ	Ausstattungsvariante	Spannung [V]	Drehrichtung
740834N	Massey Ferguson	Mähdrescher / 10-900	815	Schaft D mm 9,5 Schaftlaenge 103	12	Drehrichtung gegen den Uhrzeigersinn
740834N	Massey Ferguson	Mähdrescher / 10-900	820	Schaft D mm 9,5 Schaftlaenge 103	12	Drehrichtung gegen den Uhrzeigersinn
740832N	Massey Ferguson	Mähdrescher / 3400-9790	8570	Schaft D mm 8 Schaftlaenge 62	12	
740832N	Massey Ferguson	Mähdrescher / 3400-9790	8590	Schaft D mm 8 Schaftlaenge 62	12	
740832N	Massey Ferguson	Mähdrescher / 3400-9790	8680	Schaft D mm 8 Schaftlaenge 62	12	
740832N	Massey Ferguson	Mähdrescher / 3400-9790	8780	Schaft D mm 8 Schaftlaenge 62	12	
740831N	Massey Ferguson	Mähdrescher / MF 24-40	27	Schaft D mm 8 Schaftlaenge 38	12	
740831N	Massey Ferguson	Mähdrescher / MF 24-40	29	Schaft D mm 8 Schaftlaenge 38	12	
740831N	Massey Ferguson	Mähdrescher / MF 24-40	31	Schaft D mm 8 Schaftlaenge 38	12	
740816N	Massey Ferguson	Schlepper / 1000	1004	Schaft D mm 8 Schaftlaenge 35	12	Drehrichtung gegen den Uhrzeigersinn
740816N	Massey Ferguson	Schlepper / 1000	1007	Schaft D mm 8 Schaftlaenge 35	12	Drehrichtung gegen den Uhrzeigersinn
740816N	Massey Ferguson	Schlepper / 1000	1014	Schaft D mm 8 Schaftlaenge 35	12	Drehrichtung gegen den Uhrzeigersinn
740816N	Massey Ferguson	Schlepper / 1000	1080	Schaft D mm 8 Schaftlaenge 35	12	Drehrichtung gegen den Uhrzeigersinn
740816N	Massey Ferguson	Schlepper / 1000	1085	Schaft D mm 8 Schaftlaenge 35	12	Drehrichtung gegen den Uhrzeigersinn
740816N	Massey Ferguson	Schlepper / 1000	1100	Schaft D mm 8 Schaftlaenge 35	12	Drehrichtung gegen den Uhrzeigersinn
740816N	Massey Ferguson	Schlepper / 1000	1105	Schaft D mm 8 Schaftlaenge 35	12	Drehrichtung gegen den Uhrzeigersinn
740816N	Massey Ferguson	Schlepper / 1000	1114	Schaft D mm 8 Schaftlaenge 35	12	Drehrichtung gegen den Uhrzeigersinn
740816N	Massey Ferguson	Schlepper / 1000	1130	Schaft D mm 8 Schaftlaenge 35	12	Drehrichtung gegen den Uhrzeigersinn
740816N	Massey Ferguson	Schlepper / 1000	1134	Schaft D mm 8 Schaftlaenge 35	12	Drehrichtung gegen den Uhrzeigersinn
740816N	Massey Ferguson	Schlepper / 1000	1135	Schaft D mm 8 Schaftlaenge 35	12	Drehrichtung gegen den Uhrzeigersinn
740816N	Massey Ferguson	Schlepper / 1000	1155	Schaft D mm 8 Schaftlaenge 35	12	Drehrichtung gegen den Uhrzeigersinn
740816N	Massey Ferguson	Schlepper / 1000	1200	Schaft D mm 8 Schaftlaenge 35	12	Drehrichtung gegen den Uhrzeigersinn
740816N	Massey Ferguson	Schlepper / 1000	1250	Schaft D mm 8 Schaftlaenge 35	12	Drehrichtung gegen den Uhrzeigersinn
740813N	NEW HOLLAND	Baggerlader / 9000	9030	Schaft D mm 8	12	Drehrichtung gegen den Uhrzeigersinn

Dasis Nr.	Hersteller	Modell	Typ	Ausstattungsvariante	Spannung [V]	Drehrichtung
740831N	NEW HOLLAND	Mähdrescher / 8000	8030	Schaft D mm 8 Schaftlaenge 38	12	
740832N	NEW HOLLAND	Mähdrescher / 8000	8030	Schaft D mm 8 Schaftlaenge 62	12	
740831N	NEW HOLLAND	Mähdrescher / 8000	8040	Schaft D mm 8 Schaftlaenge 38	12	
740832N	NEW HOLLAND	Mähdrescher / 8000	8040	Schaft D mm 8 Schaftlaenge 62	12	
740831N	NEW HOLLAND	Mähdrescher / 8000	8050	Schaft D mm 8 Schaftlaenge 38	12	
740832N	NEW HOLLAND	Mähdrescher / 8000	8050	Schaft D mm 8 Schaftlaenge 62	12	
740832N	NEW HOLLAND	Mähdrescher / 8000	8055	Schaft D mm 8 Schaftlaenge 62	12	
740831N	NEW HOLLAND	Mähdrescher / 8000	8055	Schaft D mm 8 Schaftlaenge 38	12	
740832N	NEW HOLLAND	Mähdrescher / 8000	8060	Schaft D mm 8 Schaftlaenge 62	12	
740831N	NEW HOLLAND	Mähdrescher / 8000	8060	Schaft D mm 8 Schaftlaenge 38	12	
740832N	NEW HOLLAND	Mähdrescher / 8000	8070	Schaft D mm 8 Schaftlaenge 62	12	
740831N	NEW HOLLAND	Mähdrescher / 8000	8070	Schaft D mm 8 Schaftlaenge 38	12	
740832N	NEW HOLLAND	Mähdrescher / 8000	8080	Schaft D mm 8 Schaftlaenge 62	12	
740831N	NEW HOLLAND	Mähdrescher / 8000	8080	Schaft D mm 8 Schaftlaenge 38	12	
740832N	NEW HOLLAND	Mähdrescher / TF	42	Schaft D mm 8 Schaftlaenge 62	12	
740832N	NEW HOLLAND	Mähdrescher / TF	44	Schaft D mm 8 Schaftlaenge 62	12	
740832N	NEW HOLLAND	Mähdrescher / TF	46	Schaft D mm 8 Schaftlaenge 62	12	
740036N	NEW HOLLAND	Schlepper / 2110-8210	2310	Schaft D mm 9,5 Schaftlaenge 111	12	Drehrichtung im Uhrzeigersinn
740036N	NEW HOLLAND	Schlepper / 2110-8210	2610	Schaft D mm 9,5 Schaftlaenge 111	12	Drehrichtung im Uhrzeigersinn
740036N	NEW HOLLAND	Schlepper / 2110-8210	2810	Schaft D mm 9,5 Schaftlaenge 111	12	Drehrichtung im Uhrzeigersinn
740036N	NEW HOLLAND	Schlepper / 2110-8210	2910	Schaft D mm 9,5 Schaftlaenge 111	12	Drehrichtung im Uhrzeigersinn
740036N	NEW HOLLAND	Schlepper / 2110-8210	3310	Schaft D mm 9,5 Schaftlaenge 111	12	Drehrichtung im Uhrzeigersinn
740036N	NEW HOLLAND	Schlepper / 2110-8210	3610	Schaft D mm 9,5 Schaftlaenge 111	12	Drehrichtung im Uhrzeigersinn
740036N	NEW HOLLAND	Schlepper / 2110-8210	3910	Schaft D mm 9,5 Schaftlaenge 111	12	Drehrichtung im Uhrzeigersinn
740036N	NEW HOLLAND	Schlepper / 2110-8210	4110	Schaft D mm 9,5 Schaftlaenge 111	12	Drehrichtung im Uhrzeigersinn
740036N	NEW HOLLAND	Schlepper / 2110-8210	4610	Schaft D mm 9,5 Schaftlaenge 111	12	Drehrichtung im Uhrzeigersinn
740036N	NEW HOLLAND	Schlepper / 2110-8210	5110	Schaft D mm 9,5 Schaftlaenge 111	12	Drehrichtung im Uhrzeigersinn
740036N	NEW HOLLAND	Schlepper / 2110-8210	5610	Schaft D mm 9,5 Schaftlaenge 111	12	Drehrichtung im Uhrzeigersinn
740036N	NEW HOLLAND	Schlepper / 2110-8210	5710	Schaft D mm 9,5 Schaftlaenge 111	12	Drehrichtung im Uhrzeigersinn
740036N	NEW HOLLAND	Schlepper / 2110-8210	5900	Schaft D mm 9,5 Schaftlaenge 111	12	Drehrichtung im Uhrzeigersinn
740036N	NEW HOLLAND	Schlepper / 2110-8210	6410	Schaft D mm 9,5 Schaftlaenge 111	12	Drehrichtung im Uhrzeigersinn
740036N	NEW HOLLAND	Schlepper / 2110-8210	6610	Schaft D mm 9,5 Schaftlaenge 111	12	Drehrichtung im Uhrzeigersinn



Dasis Nr.	Hersteller	Modell	Typ	Ausstattungsvariante	Spannung [V]	Drehrichtung
740036N	NEW HOLLAND	Schlepper / 2110-8210	6710	Schaft D mm 9,5 Schaftlaenge 111	12	Drehrichtung im Uhrzeigersinn
740036N	NEW HOLLAND	Schlepper / 2110-8210	6810	Schaft D mm 9,5 Schaftlaenge 111	12	Drehrichtung im Uhrzeigersinn
740036N	NEW HOLLAND	Schlepper / 2110-8210	7410	Schaft D mm 9,5 Schaftlaenge 111	12	Drehrichtung im Uhrzeigersinn
740036N	NEW HOLLAND	Schlepper / 2110-8210	7610	Schaft D mm 9,5 Schaftlaenge 111	12	Drehrichtung im Uhrzeigersinn
740036N	NEW HOLLAND	Schlepper / 2110-8210	7710	Schaft D mm 9,5 Schaftlaenge 111	12	Drehrichtung im Uhrzeigersinn
740036N	NEW HOLLAND	Schlepper / 2110-8210	7810	Schaft D mm 9,5 Schaftlaenge 111	12	Drehrichtung im Uhrzeigersinn
740036N	NEW HOLLAND	Schlepper / 2110-8210	7910	Schaft D mm 9,5 Schaftlaenge 111	12	Drehrichtung im Uhrzeigersinn
740036N	NEW HOLLAND	Schlepper / 2110-8210	8210	Schaft D mm 9,5 Schaftlaenge 111	12	Drehrichtung im Uhrzeigersinn
740036N	NEW HOLLAND	Schlepper /4110-8210	5110	Schaft D mm 9,5 Schaftlaenge 111	12	Drehrichtung im Uhrzeigersinn
740036N	NEW HOLLAND	Schlepper /4110-8210	5610	Schaft D mm 9,5 Schaftlaenge 111	12	Drehrichtung im Uhrzeigersinn
740036N	NEW HOLLAND	Schlepper /4110-8210	6410	Schaft D mm 9,5 Schaftlaenge 111	12	Drehrichtung im Uhrzeigersinn
740036N	NEW HOLLAND	Schlepper /4110-8210	6610	Schaft D mm 9,5 Schaftlaenge 111	12	Drehrichtung im Uhrzeigersinn
740036N	NEW HOLLAND	Schlepper /4110-8210	6810	Schaft D mm 9,5 Schaftlaenge 111	12	Drehrichtung im Uhrzeigersinn
740036N	NEW HOLLAND	Schlepper /4110-8210	7410	Schaft D mm 9,5 Schaftlaenge 111	12	Drehrichtung im Uhrzeigersinn
740036N	NEW HOLLAND	Schlepper /4110-8210	7610	Schaft D mm 9,5 Schaftlaenge 111	12	Drehrichtung im Uhrzeigersinn
740036N	NEW HOLLAND	Schlepper /4110-8210	7710	Schaft D mm 9,5 Schaftlaenge 111	12	Drehrichtung im Uhrzeigersinn
740036N	NEW HOLLAND	Schlepper /4110-8210	7810	Schaft D mm 9,5 Schaftlaenge 111	12	Drehrichtung im Uhrzeigersinn
740036N	NEW HOLLAND	Schlepper /4110-8210	7910	Schaft D mm 9,5 Schaftlaenge 111	12	Drehrichtung im Uhrzeigersinn
740036N	NEW HOLLAND	Schlepper /4110-8210	8210	Schaft D mm 9,5 Schaftlaenge 111	12	Drehrichtung im Uhrzeigersinn

Dasis Nr.	Hersteller	Modell	Typ	Spezifikation	Innengewindemaß Druckseite	Innengewindemaß Saugseite	Außengewindemaß Druckseite	Außengewindemaß Saugseite	Kapillarrohrlänge [mm]
840380N	Agco	Raupen Dozer / MT	T700						
840280N	Agco	Raupen Dozer / MT	T700						
840380N	Agco	Raupen Dozer / MT	T800						
840280N	Agco	Raupen Dozer / MT	T800						
840086N	Agco	Selbstfahrende Farbspritze / Rogator 600-874	654	Innengewinde					
840086N	Agco	Selbstfahrende Farbspritze / Rogator 600-874	664	Innengewinde					
840086N	Agco	Selbstfahrende Farbspritze / Rogator 600-874	844	Innengewinde					
840086N	Agco	Selbstfahrende Farbspritze / Rogator 600-874	854	Innengewinde					
840086N	Agco	Selbstfahrende Farbspritze / Rogator 600-874	864	Innengewinde					
840086N	Agco	Selbstfahrende Farbspritze / Rogator 600-874	874	Innengewinde					
840130N	Agco	Selbstfahrende Farbspritze / Rogator 1000	1054	O-Ring					
840130N	Agco	Selbstfahrende Farbspritze / Rogator 1000	1064	O-Ring					
840130N	Agco	Selbstfahrende Farbspritze / Rogator 1000	1074	O-Ring					
840130N	Agco	Selbstfahrende Farbspritze / Rogator 1000	1254	O-Ring					
840130N	Agco	Selbstfahrende Farbspritze / Rogator 1000	1264	O-Ring					
840130N	Agco	Selbstfahrende Farbspritze / Rogator 1000	1274	O-Ring					

Dasis Nr.	Hersteller	Modell	Typ	Spezifikation	Innengewindemaß Druckseite	Innengewindemaß Saugseite	Außengewindemaß Druckseite	Außengewindemaß Saugseite	Kapillarrohrlänge [mm]
840086N	Agco	Selbstfahrende Farbspritze / Terragator 1000	1603	Innengewinde					
840130N	Agco	Selbstfahrende Farbspritze / Terragator 1000	1844	O-Ring					
840130N	Agco	Selbstfahrende Farbspritze / Terragator 1000	1903	O-Ring					
840130N	Agco	Selbstfahrende Farbspritze / Terragator 8000	8103	O-Ring					
840130N	Agco	Selbstfahrende Farbspritze / Terragator 8000	8104	O-Ring					
840130N	Agco	Selbstfahrende Farbspritze / Terragator 9000	9103	O-Ring					
840130N	Agco	Selbstfahrende Farbspritze / Terragator 9000	9105	O-Ring					
840370N	Bateman	Selbstfahrende Farbspritze / RB	15				16	18	
840370N	Bateman	Selbstfahrende Farbspritze / RB	16				16	18	
840370N	Bateman	Selbstfahrende Farbspritze / RB	25				16	18	
840490N	Braud NH	Selbstfahrende Farbspritze / SB	33	O-Ring			16,0	18,0	355
840490N	Braud NH	Selbstfahrende Farbspritze / SB	35	O-Ring			16,0	18,0	355
840490N	Braud NH	Selbstfahrende Farbspritze / SB	36	O-Ring			16,0	18,0	355
840490N	Braud NH	Selbstfahrende Farbspritze / SB	52	O-Ring			16,0	18,0	355
840490N	Braud NH	Selbstfahrende Farbspritze / SB	53	O-Ring			16,0	18,0	355
840490N	Braud NH	Selbstfahrende Farbspritze / SB	54	O-Ring			16,0	18,0	355
840490N	Braud NH	Selbstfahrende Farbspritze / SB	55	O-Ring			16,0	18,0	355
840490N	Braud NH	Selbstfahrende Farbspritze / SB	56	O-Ring			16,0	18,0	355

Dasis Nr.	Hersteller	Modell	Typ	Spezifikation	Innengewindemaß Druckseite	Innengewindemaß Saugseite	Außengewindemaß Druckseite	Außengewindemaß Saugseite	Kapillarrohrlänge [mm]
840490N	Braud NH	Selbstfahrende Farbspritze / SB	58	O-Ring			16,0	18,0	355
840490N	Braud NH	Selbstfahrende Farbspritze / SB	60	O-Ring			16,0	18,0	355
840490N	Braud NH	Selbstfahrende Farbspritze / SB	62	O-Ring			16,0	18,0	355
840490N	Braud NH	Selbstfahrende Farbspritze / SB	64	O-Ring			16,0	18,0	355
840490N	Braud NH	Selbstfahrende Farbspritze / SB	65	O-Ring			16,0	18,0	355
840490N	Braud NH	Selbstfahrende Farbspritze / TB	10	O-Ring			16,0	18,0	355
840490N	Braud NH	Selbstfahrende Farbspritze / TB	15	O-Ring			16,0	18,0	355
840490N	Braud NH	Selbstfahrende Farbspritze / VL	610	O-Ring			16,0	18,0	355
840490N	Braud NH	Selbstfahrende Farbspritze / VL	620	O-Ring			16,0	18,0	355
840490N	Braud NH	Selbstfahrende Farbspritze / VL	630	O-Ring			16,0	18,0	355
840490N	Braud NH	Selbstfahrende Farbspritze / VL	640	O-Ring			16,0	18,0	355
840490N	Braud NH	Selbstfahrende Farbspritze / VL	660	O-Ring			16,0	18,0	355
840490N	Braud NH	Selbstfahrende Farbspritze / VN	240	O-Ring			16,0	18,0	355
840490N	Braud NH	Selbstfahrende Farbspritze / VN	260	O-Ring			16,0	18,0	355
840050N	Case International IHC	Baggerlader	580	Konus			13,0	16,0	480
840050N	Case International IHC	Baggerlader	580K	Konus			13,0	16,0	480
840086N	Case International IHC	Baggerlader	580L	Innengewinde					
840086N	Case International IHC	Baggerlader	580Super	Innengewinde					
840050N	Case International IHC	Baggerlader	580Super	Konus			13,0	16,0	480
840050N	Case International IHC	Baggerlader	580SuperE	Konus			13,0	16,0	480
840086N	Case International IHC	Baggerlader	580SuperK	Innengewinde					

Dasis Nr.	Hersteller	Modell	Typ	Spezifikation	Innengewindemaß Druckseite	Innengewindemaß Saugseite	Außengewindemaß Druckseite	Außengewindemaß Saugseite	Kapillarrohrlänge [mm]
840086N	Case International IHC	Baggerlader	580SuperL	Innengewinde					
840050N	Case International IHC	Baggerlader	581Super	Konus			13,0	16,0	480
840086N	Case International IHC	Baggerlader	581SuperK	Innengewinde					
840086N	Case International IHC	Baggerlader	590SuperL	Innengewinde					
840086N	Case International IHC	Baggerlader	590Turbo	Innengewinde					
840086N	Case International IHC	Baggerlader	591	Innengewinde					
840086N	Case International IHC	Baggerlader	591Turbo	Innengewinde					
840050N	Case International IHC	Baggerlader	680H	Konus			13,0	16,0	480
840050N	Case International IHC	Baggerlader	680K	Konus			13,0	16,0	480
840086N	Case International IHC	Baggerlader	680L	Innengewinde					
840050N	Case International IHC	Baggerlader	680L	Konus			13,0	16,0	480
840086N	Case International IHC	Baggerlader	780	Innengewinde					
840050N	Case International IHC	Baggerlader	780	Konus			13,0	16,0	480
840050N	Case International IHC	Baggerlader	780B	Konus			13,0	16,0	480
840086N	Case International IHC	Baggerlader	780Turbo	Innengewinde					
840086N	Case International IHC	Baggerlader / Magnum	7110	Innengewinde					
840086N	Case International IHC	Baggerlader / Magnum	7120	Innengewinde					
840086N	Case International IHC	Baggerlader / Magnum	7130	Innengewinde					
840086N	Case International IHC	Baggerlader / Magnum	7140	Innengewinde					
840086N	Case International IHC	Baggerlader / Magnum	7210	Innengewinde					
840086N	Case International IHC	Baggerlader / Magnum	7220	Innengewinde					

Dasis Nr.	Hersteller	Modell	Typ	Spezifikation	Innengewindemaß Druckseite	Innengewindemaß Saugseite	Außengewindemaß Druckseite	Außengewindemaß Saugseite	Kapillarrohrlänge [mm]
840086N	Case International IHC	Baggerlader / Magnum	7230	Innengewinde					
840086N	Case International IHC	Baggerlader / Magnum	7240	Innengewinde					
840086N	Case International IHC	Baggerlader / Magnum	7250	Innengewinde					
840086N	Case International IHC	Baggerlader / Maxxum	5120	Innengewinde					
840086N	Case International IHC	Baggerlader / Maxxum	5130	Innengewinde					
840086N	Case International IHC	Baggerlader / Maxxum	5140	Innengewinde					
840086N	Case International IHC	Baggerlader / Maxxum	5220	Innengewinde					
840086N	Case International IHC	Baggerlader / Maxxum	5230	Innengewinde					
840086N	Case International IHC	Baggerlader / Maxxum	5240	Innengewinde					
840086N	Case International IHC	Baggerlader / Maxxum	5250	Innengewinde					
840155N	Case International IHC	Feldhäcksler / CHX	320						
840155N	Case International IHC	Feldhäcksler / CHX	420						
840155N	Case International IHC	Feldhäcksler / CHX	520						
840155N	Case International IHC	Feldhäcksler / CHX	620						
840086N	Case International IHC	Mähdrescher / 14	1420	Innengewinde					
840086N	Case International IHC	Mähdrescher / 14	1440	Innengewinde					
840086N	Case International IHC	Mähdrescher / 14	1460	Innengewinde					
840086N	Case International IHC	Mähdrescher / 14	1470	Innengewinde					
840086N	Case International IHC	Mähdrescher / 14	1480	Innengewinde					
840120N	Case International IHC	Mähdrescher / 16	1620	O-Ring					
840086N	Case International IHC	Mähdrescher / 16	1620	Innengewinde					

Dasis Nr.	Hersteller	Modell	Typ	Spezifikation	Innengewindemaß Druckseite	Innengewindemaß Saugseite	Außengewindemaß Druckseite	Außengewindemaß Saugseite	Kapillarrohrlänge [mm]
840086N	Case International IHC	Mähdrescher / 16	1620E	Innengewinde					
840120N	Case International IHC	Mähdrescher / 16	1620E	O-Ring					
840120N	Case International IHC	Mähdrescher / 16	1640	O-Ring					
840086N	Case International IHC	Mähdrescher / 16	1640	Innengewinde					
840086N	Case International IHC	Mähdrescher / 16	1660	Innengewinde					
840086N	Case International IHC	Mähdrescher / 16	1660E	Innengewinde					
840120N	Case International IHC	Mähdrescher / 16	1660E	O-Ring					
840086N	Case International IHC	Mähdrescher / 16	1666	Innengewinde					
840120N	Case International IHC	Mähdrescher / 16	1666	O-Ring					
840086N	Case International IHC	Mähdrescher / 16	1670	Innengewinde					
840120N	Case International IHC	Mähdrescher / 16	1670	O-Ring					
840086N	Case International IHC	Mähdrescher / 16	1680E	Innengewinde					
840120N	Case International IHC	Mähdrescher / 16	1680E	O-Ring					
840086N	Case International IHC	Mähdrescher / 23	2344	Innengewinde					
840086N	Case International IHC	Mähdrescher / 23	2365	Innengewinde					
840086N	Case International IHC	Mähdrescher / 23	2366	Innengewinde					
840086N	Case International IHC	Mähdrescher / 23	2388	Innengewinde					
840086N	Case International IHC	Mähdrescher / AFX	8010	Innengewinde					
840155N	Case International IHC	Mähdrescher / AFX	8010						
840086N	Case International IHC	Mähdrescher 521- 1150	521	Innengewinde					
840086N	Case International IHC	Mähdrescher 521- 1150	570L2	Innengewinde					

Dasis Nr.	Hersteller	Modell	Typ	Spezifikation	Innengewindemaß Druckseite	Innengewindemaß Saugseite	Außengewindemaß Druckseite	Außengewindemaß Saugseite	Kapillarrohrlänge [mm]
840086N	Case International IHC	Mähdrescher 521- 1150	621	Innengewinde					
840086N	Case International IHC	Mähdrescher 521- 1150	721	Innengewinde					
840086N	Case International IHC	Mähdrescher 521- 1150	921	Innengewinde					
840086N	Case International IHC	Mähdrescher 521- 1150	1150H	Innengewinde					
840086N	Case International IHC	Raupen Dozer	780	Innengewinde					
840086N	Case International IHC	Raupen Dozer	850E	Innengewinde					
840086N	Case International IHC	Raupen Dozer	850G	Innengewinde					
840086N	Case International IHC	Raupen Dozer / Quadtrac	Quadtrac	Innengewinde					
840086N	Case International IHC	Schaufellader	521	Innengewinde					
840086N	Case International IHC	Schaufellader	570L2	Innengewinde					
840086N	Case International IHC	Schaufellader	621	Innengewinde					
840086N	Case International IHC	Schaufellader	721	Innengewinde					
840086N	Case International IHC	Schaufellader	821	Innengewinde					
840086N	Case International IHC	Schaufellader	921	Innengewinde					
840086N	Case International IHC	Schaufellader	1150H	Innengewinde					
840050N	Case International IHC	Schaufellader	W14	Konus			13,0	16,0	480
840050N	Case International IHC	Schaufellader	W14B	Konus			13,0	16,0	480
840050N	Case International IHC	Schaufellader	W14C	Konus			13,0	16,0	480
840050N	Case International IHC	Schaufellader	W18	Konus			13,0	16,0	480
840050N	Case International IHC	Schaufellader	W20C	Konus			13,0	16,0	480
840050N	Case International IHC	Schaufellader	W30	Konus			13,0	16,0	480



Dasis Nr.	Hersteller	Modell	Typ	Spezifikation	Innengewindemaß Druckseite	Innengewindemaß Saugseite	Außengewindemaß Druckseite	Außengewindemaß Saugseite	Kapillarrohrlänge [mm]
840490N	Case International IHC	Schlepper / 186-996	395	O-Ring			16,0	18,0	355
840490N	Case International IHC	Schlepper / 186-996	495	O-Ring			16,0	18,0	355
840086N	Case International IHC	Schlepper / 186-996	710E	Innengewinde					
840086N	Case International IHC	Schlepper / 186-996	766	Innengewinde					
840050N	Case International IHC	Schlepper / 186-996	766	Konus			13,0	16,0	480
840490N	Case International IHC	Schlepper / 186-996	856	O-Ring			16,0	18,0	355
840490N	Case International IHC	Schlepper / 186-996	956	O-Ring			16,0	18,0	355
840086N	Case International IHC	Schlepper / 186-996	966	Innengewinde					
840050N	Case International IHC	Schlepper / 186-996	966	Konus			13,0	16,0	480
840490N	Case International IHC	Schlepper / 1046- 1896	1056	O-Ring			16,0	18,0	355
840086N	Case International IHC	Schlepper / 1046- 1896	1066	Innengewinde					
840050N	Case International IHC	Schlepper / 1046- 1896	1066	Konus			13,0	16,0	480
840086N	Case International IHC	Schlepper / 1046- 1896	1466	Innengewinde					
840050N	Case International IHC	Schlepper / 1046- 1896	1466	Konus			13,0	16,0	480
840086N	Case International IHC	Schlepper / 1046- 1896	1566	Innengewinde					
840050N	Case International IHC	Schlepper / 1046- 1896	1566	Konus			13,0	16,0	480
840086N	Case International IHC	Schlepper / 1046- 1896	1620	Innengewinde					
840086N	Case International IHC	Schlepper / 1046- 1896	1640	Innengewinde					
840086N	Case International IHC	Schlepper / 1046- 1896	1660	Innengewinde					
840086N	Case International IHC	Schlepper / 1046- 1896	1670	Innengewinde					
840086N	Case International IHC	Schlepper / 2096- 2388	2144	Innengewinde					

Dasis Nr.	Hersteller	Modell	Typ	Spezifikation	Innengewindemaß Druckseite	Innengewindemaß Saugseite	Außengewindemaß Druckseite	Außengewindemaß Saugseite	Kapillarrohrlänge [mm]
840086N	Case International IHC	Schlepper / 2096- 2388	2166	Innengewinde					
840086N	Case International IHC	Schlepper / 2096- 2388	2188	Innengewinde					
840086N	Case International IHC	Schlepper / 2096- 2388	2344	Innengewinde					
840086N	Case International IHC	Schlepper / 2096- 2388	2365	Innengewinde					
840086N	Case International IHC	Schlepper / 2096- 2388	2366	Innengewinde					
840086N	Case International IHC	Schlepper / 2096- 2388	2388	Innengewinde					
840130N	Case International IHC	Schlepper / 3088- 3788	3088	O-Ring					
840086N	Case International IHC	Schlepper / 3088- 3788	3210	Innengewinde					
840086N	Case International IHC	Schlepper / 3088- 3788	3220	Innengewinde					
840086N	Case International IHC	Schlepper / 3088- 3788	3230	Innengewinde					
840130N	Case International IHC	Schlepper / 3088- 3788	3288	O-Ring					
840130N	Case International IHC	Schlepper / 3088- 3788	3388	O-Ring					
840130N	Case International IHC	Schlepper / 3088- 3788	3488	O-Ring					
840130N	Case International IHC	Schlepper / 3088- 3788	3588	O-Ring					
840130N	Case International IHC	Schlepper / 3088- 3788	3688	O-Ring					
840130N	Case International IHC	Schlepper / 3088- 3788	3788	O-Ring					
840340N	Case International IHC	Schlepper / 4000- 4894	4186	Konus			15,0	18,0	305
840086N	Case International IHC	Schlepper / 4000- 4894	4210	Innengewinde					
840086N	Case International IHC	Schlepper / 4000- 4894	4220	Innengewinde					
840086N	Case International IHC	Schlepper / 4000- 4894	4230	Innengewinde					
840086N	Case International IHC	Schlepper / 4000- 4894	4240	Innengewinde					

Dasis Nr.	Hersteller	Modell	Typ	Spezifikation	Innengewindemaß Druckseite	Innengewindemaß Saugseite	Außengewindemaß Druckseite	Außengewindemaß Saugseite	Kapillarrohrlänge [mm]
840340N	Case International IHC	Schlepper / 4000- 4894	4386	Konus			15,0	18,0	305
840161N	Case International IHC	Schlepper / 4000- 4894	4490						305
840161N	Case International IHC	Schlepper / 4000- 4894	4494						305
840340N	Case International IHC	Schlepper / 4000- 4894	4586	Konus			15,0	18,0	305
840161N	Case International IHC	Schlepper / 4000- 4894	4690						305
840161N	Case International IHC	Schlepper / 4000- 4894	4694						305
840340N	Case International IHC	Schlepper / 4000- 4894	4786	Konus			15,0	18,0	305
840161N	Case International IHC	Schlepper / 4000- 4894	4890						305
840161N	Case International IHC	Schlepper / 4000- 4894	4894						305
840086N	Case International IHC	Schlepper / 5088- 5488	5120	Innengewinde					
840086N	Case International IHC	Schlepper / 5088- 5488	5130	Innengewinde					
840086N	Case International IHC	Schlepper / 5088- 5488	5140	Innengewinde					
840086N	Case International IHC	Schlepper / 5088- 5488	5150	Innengewinde					
840086N	Case International IHC	Schlepper / 7110- 7488	7220E	Innengewinde					
840086N	Case International IHC	Schlepper / 8910- 8950	8910	Innengewinde					
840086N	Case International IHC	Schlepper / 8910- 8950	8920	Innengewinde					
840086N	Case International IHC	Schlepper / 8910- 8950	8930	Innengewinde					
840086N	Case International IHC	Schlepper / 8910- 8950	8940	Innengewinde					
840086N	Case International IHC	Schlepper / 8910- 8950	8950	Innengewinde					
840086N	Case International IHC	Schlepper / 9110- 9390	9110	Innengewinde					
840086N	Case International IHC	Schlepper / 9110- 9390	9130	Innengewinde					

Dasis Nr.	Hersteller	Modell	Typ	Spezifikation	Innengewindemaß Druckseite	Innengewindemaß Saugseite	Außengewindemaß Druckseite	Außengewindemaß Saugseite	Kapillarrohrlänge [mm]
840086N	Case International IHC	Schlepper / 9110- 9390	9150	Innengewinde					
840086N	Case International IHC	Schlepper / 9110- 9390	9170	Innengewinde					
840086N	Case International IHC	Schlepper / 9110- 9390	9180	Innengewinde					
840086N	Case International IHC	Schlepper / 9110- 9390	9210	Innengewinde					
840086N	Case International IHC	Schlepper / 9110- 9390	9230	Innengewinde					
840086N	Case International IHC	Schlepper / 9110- 9390	9240	Innengewinde					
840086N	Case International IHC	Schlepper / 9110- 9390	9250	Innengewinde					
840086N	Case International IHC	Schlepper / 9110- 9390	9260	Innengewinde					
840086N	Case International IHC	Schlepper / 9110- 9390	9270	Innengewinde					
840130N	Case International IHC	Schlepper / CS	75	O-Ring					
840130N	Case International IHC	Schlepper / CS	78	O-Ring					
840130N	Case International IHC	Schlepper / CS	86	O-Ring					
840130N	Case International IHC	Schlepper / CS	94	O-Ring					
840130N	Case International IHC	Schlepper / CS	100	O-Ring					
840130N	Case International IHC	Schlepper / CS	110	O-Ring					
840130N	Case International IHC	Schlepper / CS	120	O-Ring					
840130N	Case International IHC	Schlepper / CS	130	O-Ring					
840130N	Case International IHC	Schlepper / CS	150	O-Ring					
840130N	Case International IHC	Schlepper / CVX	V120	O-Ring					
840130N	Case International IHC	Schlepper / CVX	V130	O-Ring					
840130N	Case International IHC	Schlepper / CVX	V150	O-Ring					

Dasis Nr.	Hersteller	Modell	Typ	Spezifikation	Innengewindemaß Druckseite	Innengewindemaß Saugseite	Außengewindemaß Druckseite	Außengewindemaß Saugseite	Kapillarrohrlänge [mm]
840130N	Case International IHC	Schlepper / CVX	V170	O-Ring					
840130N	Case International IHC	Schlepper / CVX	V1135	O-Ring					
840130N	Case International IHC	Schlepper / CVX	V1145	O-Ring					
840130N	Case International IHC	Schlepper / CVX	V1155	O-Ring					
840130N	Case International IHC	Schlepper / CVX	V1170	O-Ring					
840130N	Case International IHC	Schlepper / CVX	V1190	O-Ring					
840086N	Case International IHC	Schlepper / CX	50	Innengewinde					
840086N	Case International IHC	Schlepper / CX	60	Innengewinde					
840086N	Case International IHC	Schlepper / CX	70	Innengewinde					
840086N	Case International IHC	Schlepper / CX	80	Innengewinde					
840086N	Case International IHC	Schlepper / CX	90	Innengewinde					
840086N	Case International IHC	Schlepper / CX	100	Innengewinde					
840166N	Case International IHC	Schlepper / JX	55	O-Ring					
840166N	Case International IHC	Schlepper / JX	60	O-Ring					
840166N	Case International IHC	Schlepper / JX	65	O-Ring					
840166N	Case International IHC	Schlepper / JX	70	O-Ring					
840166N	Case International IHC	Schlepper / JX	75	O-Ring					
840166N	Case International IHC	Schlepper / JX	80	O-Ring					
840166N	Case International IHC	Schlepper / JX	85	O-Ring					
840166N	Case International IHC	Schlepper / JX	90	O-Ring					
840166N	Case International IHC	Schlepper / JX	95	O-Ring					

Dasis Nr.	Hersteller	Modell	Typ	Spezifikation	Innengewindemaß Druckseite	Innengewindemaß Saugseite	Außengewindemaß Druckseite	Außengewindemaß Saugseite	Kapillarrohrlänge [mm]
840037N	Case International IHC	Schlepper / JXU	1070U	O-Ring	3/8 / 5/8	5/8 / 5/8			
840037N	Case International IHC	Schlepper / JXU	1080U	O-Ring	3/8 / 5/8	5/8 / 5/8			
840037N	Case International IHC	Schlepper / JXU	1090U	O-Ring	3/8 / 5/8	5/8 / 5/8			
840037N	Case International IHC	Schlepper / JXU	1100U	O-Ring	3/8 / 5/8	5/8 / 5/8			
840086N	Case International IHC	Schlepper / Magnum	225	Innengewinde					
840086N	Case International IHC	Schlepper / Magnum	250	Innengewinde					
840086N	Case International IHC	Schlepper / Magnum	255	Innengewinde					
840086N	Case International IHC	Schlepper / Magnum	280	Innengewinde					
840086N	Case International IHC	Schlepper / Magnum	310	Innengewinde					
840086N	Case International IHC	Schlepper / Magnum	335	Innengewinde					
840086N	Case International IHC	Schlepper / MX	100	Innengewinde					
840086N	Case International IHC	Schlepper / MX	110	Innengewinde					
840086N	Case International IHC	Schlepper / MX	120	Innengewinde					
840086N	Case International IHC	Schlepper / MX	135	Innengewinde					
840086N	Case International IHC	Schlepper / MX	150	Innengewinde					
840086N	Case International IHC	Schlepper / MX	180	Innengewinde					
840086N	Case International IHC	Schlepper / MX	200	Innengewinde					
840086N	Case International IHC	Schlepper / MX	210	Innengewinde					
840086N	Case International IHC	Schlepper / MX	220	Innengewinde					
840086N	Case International IHC	Schlepper / MX	230	Innengewinde					
840086N	Case International IHC	Schlepper / MX	240	Innengewinde					

Dasis Nr.	Hersteller	Modell	Typ	Spezifikation	Innengewindemaß Druckseite	Innengewindemaß Saugseite	Außengewindemaß Druckseite	Außengewindemaß Saugseite	Kapillarrohrlänge [mm]
840086N	Case International IHC	Schlepper / MX	255	Innengewinde					
840086N	Case International IHC	Schlepper / MX	270	Innengewinde					
840086N	Case International IHC	Schlepper / MX	285	Innengewinde					
840086N	Case International IHC	Schlepper / MXC	80	Innengewinde					
840086N	Case International IHC	Schlepper / MXC	90	Innengewinde					
840086N	Case International IHC	Schlepper / MXC	100	Innengewinde					
840166N	Case International IHC	Schlepper / MXM	120	O-Ring					
840166N	Case International IHC	Schlepper / MXM	130	O-Ring					
840310N	Case International IHC	Schlepper / MXM	135	O-Ring	3/8 / 1/2	5/8 / 3/4			
840166N	Case International IHC	Schlepper / MXM	140	O-Ring					
840310N	Case International IHC	Schlepper / MXM	150	O-Ring	3/8 / 1/2	5/8 / 3/4			
840166N	Case International IHC	Schlepper / MXM	155	O-Ring					
840310N	Case International IHC	Schlepper / MXM	165	O-Ring	3/8 / 1/2	5/8 / 3/4			
840166N	Case International IHC	Schlepper / MXM	175	O-Ring					
840310N	Case International IHC	Schlepper / MXM	180	O-Ring	3/8 / 1/2	5/8 / 3/4			
840166N	Case International IHC	Schlepper / MXM	190	O-Ring					
840162N	Case International IHC	Schlepper / MXU	100						
840162N	Case International IHC	Schlepper / MXU	110						
840162N	Case International IHC	Schlepper / MXU	115						
840162N	Case International IHC	Schlepper / MXU	125						
840162N	Case International IHC	Schlepper / MXU	135						

Dasis Nr.	Hersteller	Modell	Typ	Spezifikation	Innengewindemaß Druckseite	Innengewindemaß Saugseite	Außengewindemaß Druckseite	Außengewindemaß Saugseite	Kapillarrohrlänge [mm]
840086N	Case International IHC	Schlepper / Quadtrac	Quadtrac	Innengewinde					
840086N	Case International IHC	Schlepper / STX	275	Innengewinde					
840086N	Case International IHC	Schlepper / STX	325	Innengewinde					
840086N	Case International IHC	Schlepper / STX	375	Innengewinde					
840086N	Case International IHC	Schlepper / STX	425	Innengewinde					
840086N	Case International IHC	Schlepper / STX	440	Innengewinde					
840086N	Case International IHC	Schlepper / STX	450	Innengewinde					
840086N	Case International IHC	Schlepper / STX	500	Innengewinde					
840050N	Case International IHC	Schlepper / W	W36	Konus			13,0	16,0	480
840130N	Caterpillar	Bagger 360 Grad / 200	215	O-Ring					
840490N	Caterpillar	Bagger 360 Grad / 200	215	O-Ring			16,0	18,0	355
840130N	Caterpillar	Bagger 360 Grad / 200	225	O-Ring					
840130N	Caterpillar	Bagger 360 Grad / 200	235	O-Ring					
840490N	Caterpillar	Bagger 360 Grad / 200	235	O-Ring			16,0	18,0	355
840130N	Caterpillar	Bagger 360 Grad / 200	245	O-Ring					
840490N	Caterpillar	Bagger 360 Grad / 200	245	O-Ring			16,0	18,0	355
840353N	Caterpillar	Bagger 360 Grad / 300 Serie	312E						
840353N	Caterpillar	Bagger 360 Grad / 300 Serie	312E L						
840353N	Caterpillar	Bagger 360 Grad / 300 Serie	316E L						
840353N	Caterpillar	Bagger 360 Grad / 300 Serie	318E L						
840353N	Caterpillar	Bagger 360 Grad / 300 Serie	320E						



Dasis Nr.	Hersteller	Modell	Typ	Spezifikation	Innengewindemaß Druckseite	Innengewindemaß Saugseite	Außengewindemaß Druckseite	Außengewindemaß Saugseite	Kapillarrohrlänge [mm]
840353N	Caterpillar	Bagger 360 Grad / 300 Serie	320E L						
840353N	Caterpillar	Bagger 360 Grad / 300 Serie	320E LN						
840353N	Caterpillar	Bagger 360 Grad / 300 Serie	320E LRR						
840353N	Caterpillar	Bagger 360 Grad / 300 Serie	320E RR						
840353N	Caterpillar	Bagger 360 Grad / 300 Serie	323E L						
840353N	Caterpillar	Bagger 360 Grad / 300 Serie	323F						
840353N	Caterpillar	Bagger 360 Grad / 300 Serie	324E						
840353N	Caterpillar	Bagger 360 Grad / 300 Serie	324E L						
840353N	Caterpillar	Bagger 360 Grad / 300 Serie	324E LN						
840353N	Caterpillar	Bagger 360 Grad / 300 Serie	329E						
840353N	Caterpillar	Bagger 360 Grad / 300 Serie	329E L						
840353N	Caterpillar	Bagger 360 Grad / 300 Serie	329E LN						
840353N	Caterpillar	Bagger 360 Grad / 300 Serie	336E						
840353N	Caterpillar	Bagger 360 Grad / 300 Serie	336E H						
840353N	Caterpillar	Bagger 360 Grad / 300 Serie	336E L						
840353N	Caterpillar	Bagger 360 Grad / 300 Serie	336E LH						
840353N	Caterpillar	Bagger 360 Grad / 300 Serie	336E LN						
840353N	Caterpillar	Bagger 360 Grad / 300 Serie	336F L						
840353N	Caterpillar	Bagger 360 Grad / 300 Serie	349E						
840353N	Caterpillar	Bagger 360 Grad / 300 Serie	349E L						
840353N	Caterpillar	Bagger 360 Grad / 300 Serie	349F L						

Dasis Nr.	Hersteller	Modell	Typ	Spezifikation	Innengewindemaß Druckseite	Innengewindemaß Saugseite	Außengewindemaß Druckseite	Außengewindemaß Saugseite	Kapillarrohrlänge [mm]
840353N	Caterpillar	Bagger 360 Grad / 300 Serie	374F L						
840353N	Caterpillar	Bagger 360 Grad / 300 Serie	390F L						
840129N	Caterpillar	Baggerlader / 400	416						
840380N	Caterpillar	Baggerlader / 400	416						
840380N	Caterpillar	Baggerlader / 400	420						
840380N	Caterpillar	Baggerlader / 400	428						
840380N	Caterpillar	Baggerlader / 400	430						
840380N	Caterpillar	Baggerlader / 400	436						
840380N	Caterpillar	Baggerlader / 400	438						
840380N	Caterpillar	Baggerlader / 400	442						
840130N	Caterpillar	Baggerlader / 400B	416	O-Ring					
840130N	Caterpillar	Baggerlader / 400B	426	O-Ring					
840380N	Caterpillar	Baggerlader / 400C	436						
840380N	Caterpillar	Baggerlader / 400C	438						
840380N	Caterpillar	Baggerlader / 400D	420						
840380N	Caterpillar	Baggerlader / 400D	428						
840380N	Caterpillar	Baggerlader / 400D	430						
840380N	Caterpillar	Baggerlader / 400D	442						
840660N	Caterpillar	Kniegelenke Truck / 3/5C	315	O-Ring					
840129N	Caterpillar	Kniegelenke Truck / D	300						
840050N	Caterpillar	Minibagger / Landfill	815	Konus			13,0	16,0	480
840050N	Caterpillar	Minibagger / Landfill	816	Konus			13,0	16,0	480
840050N	Caterpillar	Minibagger / Landfill	826B	Konus			13,0	16,0	480
840050N	Caterpillar	Minibagger / Landfill	834	Konus			13,0	16,0	480
840050N	Caterpillar	Minibagger / Landfill	835	Konus			13,0	16,0	480
840380N	Caterpillar	Motorgrader / H	14						
840380N	Caterpillar	Motorgrader / H	16						
840380N	Caterpillar	Motorgrader / H	120						
840380N	Caterpillar	Motorgrader / H	140						
840380N	Caterpillar	Motorgrader / H	143						

Dasis Nr.	Hersteller	Modell	Typ	Spezifikation	Innengewindemaß Druckseite	Innengewindemaß Saugseite	Außengewindemaß Druckseite	Außengewindemaß Saugseite	Kapillarrohrlänge [mm]
840380N	Caterpillar	Motorgrader / H	163						
840380N	Caterpillar	Muldenkipper / 700	769						
840380N	Caterpillar	Muldenkipper / 700	771						
840380N	Caterpillar	Muldenkipper / 700	775						
840490N	Caterpillar	Raupen Dozer / 900	931	O-Ring			16,0	18,0	355
840490N	Caterpillar	Raupen Dozer / 900	931B	O-Ring			16,0	18,0	355
840380N	Caterpillar	Raupen Dozer / 900	939						
840130N	Caterpillar	Raupen Dozer / 900	941B	O-Ring					
840490N	Caterpillar	Raupen Dozer / 900	943B	O-Ring			16,0	18,0	355
840130N	Caterpillar	Raupen Dozer / 900	951	O-Ring					
840050N	Caterpillar	Raupen Dozer / 900	951B	Konus			13,0	16,0	480
840490N	Caterpillar	Raupen Dozer / 900	953	O-Ring			16,0	18,0	355
840380N	Caterpillar	Raupen Dozer / 900	955						
840490N	Caterpillar	Raupen Dozer / 900	955	O-Ring			16,0	18,0	355
840130N	Caterpillar	Raupen Dozer / 900	955L	O-Ring					
840380N	Caterpillar	Raupen Dozer / 900	963						
840490N	Caterpillar	Raupen Dozer / 900	963	O-Ring			16,0	18,0	355
840380N	Caterpillar	Raupen Dozer / 900	973						
840490N	Caterpillar	Raupen Dozer / 900	973	O-Ring			16,0	18,0	355
840129N	Caterpillar	Raupen Dozer / 900	992						
840380N	Caterpillar	Raupen Dozer / D	10R						
840130N	Caterpillar	Raupen Dozer / D	4	O-Ring					
840130N	Caterpillar	Raupen Dozer / D	4E	O-Ring					
840490N	Caterpillar	Raupen Dozer / D	4E	O-Ring			16,0	18,0	355
840130N	Caterpillar	Raupen Dozer / D	5B	O-Ring					
840490N	Caterpillar	Raupen Dozer / D	5B	O-Ring			16,0	18,0	355
840130N	Caterpillar	Raupen Dozer / D	5H	O-Ring					
840490N	Caterpillar	Raupen Dozer / D	6	O-Ring			16,0	18,0	355
840050N	Caterpillar	Raupen Dozer / D	8	Konus			13,0	16,0	480
840050N	Caterpillar	Raupen Dozer / D	8H	Konus			13,0	16,0	480
840380N	Caterpillar	Raupen Dozer / D	9R						

Dasis Nr.	Hersteller	Modell	Typ	Spezifikation	Innengewindemaß Druckseite	Innengewindemaß Saugseite	Außengewindemaß Druckseite	Außengewindemaß Saugseite	Kapillarrohrlänge [mm]
840050N	Caterpillar	Raupen Dozer / D	10	Konus			13,0	16,0	480
840086N	Caterpillar	Raupen Schlepper / Challenger	35	Innengewinde					
840086N	Caterpillar	Raupen Schlepper / Challenger	45	Innengewinde					
840086N	Caterpillar	Raupen Schlepper / Challenger	55	Innengewinde					
840670N	Caterpillar	Raupen Schlepper / Challenger	65						
840670N	Caterpillar	Raupen Schlepper / Challenger	75						
840670N	Caterpillar	Raupen Schlepper / Challenger	85						
840280N	Caterpillar	Schaufellader / 900	914G						
840130N	Caterpillar	Schaufellader / 900	916	O-Ring					
840050N	Caterpillar	Schaufellader / 900	920	Konus			13,0	16,0	480
840280N	Caterpillar	Schaufellader / 900	924G						
840130N	Caterpillar	Schaufellader / 900	926E	O-Ring					
840280N	Caterpillar	Schaufellader / 900	930G						
840130N	Caterpillar	Schaufellader / 900	936	O-Ring					
840050N	Caterpillar	Schaufellader / 900	950	Konus			13,0	16,0	480
840280N	Caterpillar	Schaufellader / 900	980H						
840380N	Caterpillar	Schaufellader / 900	990H						
840050N	Caterpillar	Schürfzüge / Coal bowl	637	Konus			13,0	16,0	480
840050N	Caterpillar	Schürfzüge / Coal bowl	637D	Konus			13,0	16,0	480
840050N	Caterpillar	Schürfzüge / Coal bowl	637E	Konus			13,0	16,0	480
840490N	Caterpillar	Schürfzüge / Coal bowl	639	O-Ring			16,0	18,0	355
840490N	Caterpillar	Schürfzüge / Elevating	613B	O-Ring			16,0	18,0	355
840490N	Caterpillar	Schürfzüge / Elevating	613C	O-Ring			16,0	18,0	355
840490N	Caterpillar	Schürfzüge / Elevating	615	O-Ring			16,0	18,0	355
840380N	Caterpillar	Schürfzüge / H	163						

Dasis Nr.	Hersteller	Modell	Typ	Spezifikation	Innengewindemaß Druckseite	Innengewindemaß Saugseite	Außengewindemaß Druckseite	Außengewindemaß Saugseite	Kapillarrohrlänge [mm]
840130N	Caterpillar	Schürfzüge / Open bowl	621	O-Ring					
840050N	Caterpillar	Schürfzüge / Open bowl	621	Konus			13,0	16,0	480
840130N	Caterpillar	Schürfzüge / Open bowl	621B	O-Ring					
840130N	Caterpillar	Schürfzüge / Open bowl	626	O-Ring					
840130N	Caterpillar	Schürfzüge / Open bowl	627	O-Ring					
840050N	Caterpillar	Schürfzüge / Open bowl	627	Konus			13,0	16,0	480
840130N	Caterpillar	Schürfzüge / Open bowl	627B	O-Ring					
840490N	Caterpillar	Schürfzüge / Open bowl	627B	O-Ring			16,0	18,0	355
840130N	Caterpillar	Schürfzüge / Open bowl	631	O-Ring					
840490N	Caterpillar	Schürfzüge / Open bowl	631	O-Ring			16,0	18,0	355
840050N	Caterpillar	Schürfzüge / Open bowl	631	Konus			13,0	16,0	480
840130N	Caterpillar	Schürfzüge / Open bowl	631E	O-Ring					
840130N	Caterpillar	Schürfzüge / Open bowl	633	O-Ring					
840490N	Caterpillar	Schürfzüge / Open bowl	633	O-Ring			16,0	18,0	355
840050N	Caterpillar	Schürfzüge / Open bowl	633	Konus			13,0	16,0	480
840490N	Caterpillar	Schürfzüge / Open bowl	637	O-Ring			16,0	18,0	355
840050N	Caterpillar	Schürfzüge / Open bowl	637	Konus			13,0	16,0	480
840130N	Caterpillar	Schürfzüge / Open bowl	639	O-Ring					
840490N	Caterpillar	Schürfzüge / Open bowl	639	O-Ring			16,0	18,0	355
840130N	Caterpillar	Schürfzüge / Open bowl	639D	O-Ring					
840130N	Caterpillar	Schürfzüge / Open bowl	641B	O-Ring					

Dasis Nr.	Hersteller	Modell	Typ	Spezifikation	Innengewindemaß Druckseite	Innengewindemaß Saugseite	Außengewindemaß Druckseite	Außengewindemaß Saugseite	Kapillarrohrlänge [mm]
840050N	Caterpillar	Schürfzüge / Open bowl	641B	Konus			13,0	16,0	480
840130N	Caterpillar	Schürfzüge / Open bowl	650B	O-Ring					
840050N	Caterpillar	Schürfzüge / Open bowl	650B	Konus			13,0	16,0	480
840130N	Caterpillar	Schürfzüge / Open bowl	651B	O-Ring					
840050N	Caterpillar	Schürfzüge / Open bowl	651B	Konus			13,0	16,0	480
840380N	Caterpillar	Walzenzüge / 400	446D						
840130N	Caterpillar	Walzenzüge / Landfill	815	O-Ring					
840130N	Caterpillar	Walzenzüge / Landfill	815B	O-Ring					
840130N	Caterpillar	Walzenzüge / Landfill	816	O-Ring					
840130N	Caterpillar	Walzenzüge / Landfill	816C	O-Ring					
840130N	Caterpillar	Walzenzüge / Landfill	824	O-Ring					
840130N	Caterpillar	Walzenzüge / Landfill	824B	O-Ring					
840130N	Caterpillar	Walzenzüge / Landfill	825	O-Ring					
840130N	Caterpillar	Walzenzüge / Landfill	825C	O-Ring					
840130N	Caterpillar	Walzenzüge / Landfill	826B	O-Ring					
840130N	Caterpillar	Walzenzüge / Landfill	834	O-Ring					
840130N	Caterpillar	Walzenzüge / Landfill	835	O-Ring					
840290N	Claas	Feldhäcksler / Jaguar	685	Innengewinde					
840490N	Claas	Feldhäcksler / Jaguar	685	O-Ring			16,0	18,0	355
840290N	Claas	Feldhäcksler / Jaguar	690	Innengewinde					
840490N	Claas	Feldhäcksler / Jaguar	690	O-Ring			16,0	18,0	355
840290N	Claas	Feldhäcksler / Jaguar	695	Innengewinde					
840490N	Claas	Feldhäcksler / Jaguar	695	O-Ring			16,0	18,0	355
840490N	Claas	Feldhäcksler / Jaguar	860	O-Ring			16,0	18,0	355

Dasis Nr.	Hersteller	Modell	Typ	Spezifikation	Innengewindemaß Druckseite	Innengewindemaß Saugseite	Außengewindemaß Druckseite	Außengewindemaß Saugseite	Kapillarrohrlänge [mm]
840490N	Claas	Feldhäcksler / Jaguar	880	O-Ring			16,0	18,0	355
840290N	Claas	Feldhäcksler / Mega	202	Innengewinde					
840290N	Claas	Feldhäcksler / Mega	203	Innengewinde					
840290N	Claas	Feldhäcksler / Mega	204	Innengewinde					
840290N	Claas	Feldhäcksler / Mega	208	Innengewinde					
840290N	Claas	Feldhäcksler / Mega	218	Innengewinde					
840490N	Claas	Mähdrescher / Dominator 6	56	O-Ring			16,0	18,0	355
840490N	Claas	Mähdrescher / Dominator 6	66	O-Ring			16,0	18,0	355
840490N	Claas	Mähdrescher / Dominator 6	76	O-Ring			16,0	18,0	355
840490N	Claas	Mähdrescher / Dominator 6	86	O-Ring			16,0	18,0	355
840490N	Claas	Mähdrescher / Dominator 6	96	O-Ring			16,0	18,0	355
840490N	Claas	Mähdrescher / Dominator 6	106	O-Ring			16,0	18,0	355
840490N	Claas	Mähdrescher / Dominator 6	116	O-Ring			16,0	18,0	355
840290N	Claas	Mähdrescher / Dominator 8	98	Innengewinde					
840290N	Claas	Mähdrescher / Mega	202	Innengewinde					
840290N	Claas	Mähdrescher / Mega	203	Innengewinde					
840290N	Claas	Mähdrescher / Mega	204	Innengewinde					
840290N	Claas	Mähdrescher / Mega	208	Innengewinde					
840290N	Claas	Mähdrescher / Mega	218	Innengewinde					
840086N	Claas	Raupen Dozer / Challenger	35	Innengewinde					
840086N	Claas	Raupen Dozer / Challenger	45	Innengewinde					
840086N	Claas	Raupen Dozer / Challenger	55	Innengewinde					
840130N	Claas	Targo	40	O-Ring					
840130N	Claas	Targo	50	O-Ring					
840130N	Claas	Targo	K50	O-Ring					
840130N	Claas	Targo	K60	O-Ring					

Dasis Nr.	Hersteller	Modell	Typ	Spezifikation	Innengewindemaß Druckseite	Innengewindemaß Saugseite	Außengewindemaß Druckseite	Außengewindemaß Saugseite	Kapillarrohrlänge [mm]
840130N	Claas	Targo	K70	O-Ring					
840130N	Claas	Teleskoplader / Ranger	920	O-Ring					
840130N	Claas	Teleskoplader / Ranger	925	O-Ring					
840130N	Claas	Teleskoplader / Ranger	928	O-Ring					
840130N	Claas	Teleskoplader / Ranger	964	O-Ring					
840130N	Claas	Teleskoplader / Ranger	965	O-Ring					
840130N	Claas	Teleskoplader / Ranger	974	O-Ring					
840130N	Claas	Teleskoplader / Ranger	975	O-Ring					
840130N	Deutz	Schlepper / AgroPrima DX	4.31	O-Ring					
840130N	Deutz	Schlepper / AgroPrima DX	4.51	O-Ring					
840130N	Deutz	Schlepper / AgroPrima DX	4.56	O-Ring					
840130N	Deutz	Schlepper / AgroPrima DX	6.06	O-Ring					
840130N	Deutz	Schlepper / AgroPrima DX	6.16	O-Ring					
840130N	Deutz	Schlepper / AgroStar DX	4.61	O-Ring					
840130N	Deutz	Schlepper / AgroStar DX	4.71	O-Ring					
840130N	Deutz	Schlepper / AgroStar DX	6.11	O-Ring					
840130N	Deutz	Schlepper / AgroStar DX	6.21	O-Ring					
840130N	Deutz	Schlepper / AgroStar DX	6.31	O-Ring					
840130N	Deutz	Schlepper / AgroStar DX	6.61	O-Ring					
840130N	Deutz	Schlepper / AgroStar Freisicht S.	4.68	O-Ring					
840130N	Deutz	Schlepper / AgroStar Freisicht S.	4.78	O-Ring					
840130N	Deutz	Schlepper / AgroStar Freisicht S.	6.08	O-Ring					



Dasis Nr.	Hersteller	Modell	Typ	Spezifikation	Innengewindemaß Druckseite	Innengewindemaß Saugseite	Außengewindemaß Druckseite	Außengewindemaß Saugseite	Kapillarrohrlänge [mm]
840130N	Deutz	Schlepper / AgroStar Freisicht S.	6.28	O-Ring					
840130N	Deutz	Schlepper / AgroStar Freisicht S.	6.38	O-Ring					
840130N	Deutz	Schlepper / AgroStar TG	6.71	O-Ring					
840130N	Deutz	Schlepper / AgroStar TG	6.81	O-Ring					
840154N	Deutz	Schlepper / Agrottron mk1	4.70						
840154N	Deutz	Schlepper / Agrottron mk1	4.80						
840154N	Deutz	Schlepper / Agrottron mk1	4.85						
840154N	Deutz	Schlepper / Agrottron mk1	4.90						
840154N	Deutz	Schlepper / Agrottron mk1	4.95						
840154N	Deutz	Schlepper / Agrottron mk1	6.00						
840154N	Deutz	Schlepper / Agrottron mk1	6.01						
840154N	Deutz	Schlepper / Agrottron mk1	6.05						
840154N	Deutz	Schlepper / Agrottron mk1	6.15						
840154N	Deutz	Schlepper / Agrottron mk1	6.20						
840154N	Deutz	Schlepper / Agrottron mk1	6.30						
840154N	Deutz	Schlepper / Agrottron mk1	6.45						
840154N	Deutz	Schlepper / Agrottron mk2	80						
840154N	Deutz	Schlepper / Agrottron mk2	85						
840154N	Deutz	Schlepper / Agrottron mk2	90						
840154N	Deutz	Schlepper / Agrottron mk2	100						
840154N	Deutz	Schlepper / Agrottron mk2	105						

Dasis Nr.	Hersteller	Modell	Typ	Spezifikation	Innengewindemaß Druckseite	Innengewindemaß Saugseite	Außengewindemaß Druckseite	Außengewindemaß Saugseite	Kapillarrohrlänge [mm]
840154N	Deutz	Schlepper / Agrottron mk2	106						
840154N	Deutz	Schlepper / Agrottron mk2	110						
840154N	Deutz	Schlepper / Agrottron mk2	115						
840154N	Deutz	Schlepper / Agrottron mk2	120						
840154N	Deutz	Schlepper / Agrottron mk2	135						
840154N	Deutz	Schlepper / Agrottron mk2	150						
840154N	Deutz	Schlepper / Agrottron mk2	160						
840154N	Deutz	Schlepper / Agrottron mk2	175						
840154N	Deutz	Schlepper / Agrottron mk2	200						
840154N	Deutz	Schlepper / Agrottron mk2	230						
840154N	Deutz	Schlepper / Agrottron mk2	260						
840154N	Deutz	Schlepper / Agrottron mk3	80						
840154N	Deutz	Schlepper / Agrottron mk3	85						
840154N	Deutz	Schlepper / Agrottron mk3	90						
840154N	Deutz	Schlepper / Agrottron mk3	100						
840154N	Deutz	Schlepper / Agrottron mk3	105						
840154N	Deutz	Schlepper / Agrottron mk3	106						
840154N	Deutz	Schlepper / Agrottron mk3	110						
840154N	Deutz	Schlepper / Agrottron mk3	115						
840154N	Deutz	Schlepper / Agrottron mk3	120						
840154N	Deutz	Schlepper / Agrottron mk3	135						

Dasis Nr.	Hersteller	Modell	Typ	Spezifikation	Innengewindemaß Druckseite	Innengewindemaß Saugseite	Außengewindemaß Druckseite	Außengewindemaß Saugseite	Kapillarrohrlänge [mm]
840154N	Deutz	Schlepper / Agrottron mk3	150						
840154N	Deutz	Schlepper / Agrottron mk3	160						
840154N	Deutz	Schlepper / Agrottron mk3	175						
840154N	Deutz	Schlepper / Agrottron mk3	200						
840154N	Deutz	Schlepper / Agrottron mk3	230						
840154N	Deutz	Schlepper / Agrottron mk3	260						
840130N	Deutz	Schlepper / DO7	2807	O-Ring					
840130N	Deutz	Schlepper / DO7	3607	O-Ring					
840130N	Deutz	Schlepper / DO7	4007	O-Ring					
840130N	Deutz	Schlepper / DO7	4507	O-Ring					
840130N	Deutz	Schlepper / DO7	4807	O-Ring					
840130N	Deutz	Schlepper / DO7	5207	O-Ring					
840130N	Deutz	Schlepper / DO7	6007	O-Ring					
840130N	Deutz	Schlepper / DO7	6207	O-Ring					
840130N	Deutz	Schlepper / DO7	6507	O-Ring					
840130N	Deutz	Schlepper / DO7	6807	O-Ring					
840130N	Deutz	Schlepper / DO7	6907	O-Ring					
840130N	Deutz	Schlepper / DO7	7007	O-Ring					
840130N	Deutz	Schlepper / DO7	7207	O-Ring					
840130N	Deutz	Schlepper / DO7	7807	O-Ring					
840130N	Deutz	Schlepper / DX	80	O-Ring					
840130N	Deutz	Schlepper / DX	85	O-Ring					
840130N	Deutz	Schlepper / DX	86	O-Ring					
840130N	Deutz	Schlepper / DX	90	O-Ring					
840130N	Deutz	Schlepper / DX	92	O-Ring					
840130N	Deutz	Schlepper / DX	110	O-Ring					
840130N	Deutz	Schlepper / DX	120	O-Ring					
840130N	Deutz	Schlepper / DX	140	O-Ring					
840130N	Deutz	Schlepper / DX	145	O-Ring					

Dasis Nr.	Hersteller	Modell	Typ	Spezifikation	Innengewindemaß Druckseite	Innengewindemaß Saugseite	Außengewindemaß Druckseite	Außengewindemaß Saugseite	Kapillarrohrlänge [mm]
840130N	Deutz	Schlepper / DX	160	O-Ring					
840130N	Deutz	Schlepper / DX	230	O-Ring					
840130N	Deutz	Schlepper / DX	250	O-Ring					
840130N	Deutz	Schlepper / DX3	3.10	O-Ring					
840130N	Deutz	Schlepper / DX3	3.30	O-Ring					
840130N	Deutz	Schlepper / DX3	3.50	O-Ring					
840130N	Deutz	Schlepper / DX3	3.60	O-Ring					
840130N	Deutz	Schlepper / DX3	3.65	O-Ring					
840130N	Deutz	Schlepper / DX3	3.70	O-Ring					
840130N	Deutz	Schlepper / DX3	3.80	O-Ring					
840130N	Deutz	Schlepper / DX3	3.90	O-Ring					
840130N	Deutz	Schlepper / Hopfen	4.17	O-Ring					
840130N	Deutz	Schlepper / Hopfen	4.57	O-Ring					
840130N	Deutz	Schlepper / Intrac	6.30	O-Ring					
840130N	Deutz	Schlepper / Intrac	6.60	O-Ring					
840130N	Deutz	Schlepper / Intrac	2002	O-Ring					
840130N	Deutz	Schlepper / Intrac	2003	O-Ring					
840130N	Deutz	Schlepper / Intrac	2004	O-Ring					
840037N	Fendt	Mähdrescher / 5220-5275	5220	O-Ring	3/8 / 5/8	5/8 / 5/8			
840037N	Fendt	Mähdrescher / 5220-5275	5250	O-Ring	3/8 / 5/8	5/8 / 5/8			
840037N	Fendt	Mähdrescher / 6270-6350	6300	O-Ring	3/8 / 5/8	5/8 / 5/8			
840037N	Fendt	Mähdrescher / 6270-6350	6350	O-Ring	3/8 / 5/8	5/8 / 5/8			
840660N	Fendt	Mähdrescher / Farmer 200	275V	O-Ring					
840660N	Fendt	Mähdrescher / Farmer 200	275VA	O-Ring					
840660N	Fendt	Mähdrescher / Farmer 200	280VA	O-Ring					
840660N	Fendt	Schlepper / Farmer 200	205P	O-Ring					
840660N	Fendt	Schlepper / Farmer 200	205PA	O-Ring					

Dasis Nr.	Hersteller	Modell	Typ	Spezifikation	Innengewindemaß Druckseite	Innengewindemaß Saugseite	Außengewindemaß Druckseite	Außengewindemaß Saugseite	Kapillarrohrlänge [mm]
840660N	Fendt	Schlepper / Farmer 200	206V	O-Ring					
840660N	Fendt	Schlepper / Farmer 200	206VA	O-Ring					
840660N	Fendt	Schlepper / Farmer 200	207V	O-Ring					
840660N	Fendt	Schlepper / Farmer 200	207VA	O-Ring					
840660N	Fendt	Schlepper / Farmer 200	208PA	O-Ring					
840660N	Fendt	Schlepper / Farmer 200	209PA	O-Ring					
840660N	Fendt	Schlepper / Farmer 200	209VA	O-Ring					
840660N	Fendt	Schlepper / Farmer 200	250K	O-Ring					
840490N	Fendt	Schlepper / Farmer 200	250K	O-Ring			16,0	18,0	355
840660N	Fendt	Schlepper / Farmer 200	250KA	O-Ring					
840490N	Fendt	Schlepper / Farmer 200	250KA	O-Ring			16,0	18,0	355
840660N	Fendt	Schlepper / Farmer 200	250LE	O-Ring					
840490N	Fendt	Schlepper / Farmer 200	250LE	O-Ring			16,0	18,0	355
840660N	Fendt	Schlepper / Farmer 200	250S	O-Ring					
840490N	Fendt	Schlepper / Farmer 200	250S	O-Ring			16,0	18,0	355
840660N	Fendt	Schlepper / Farmer 200	250SA	O-Ring					
840490N	Fendt	Schlepper / Farmer 200	250SA	O-Ring			16,0	18,0	355
840660N	Fendt	Schlepper / Farmer 200	250V	O-Ring					
840660N	Fendt	Schlepper / Farmer 200	250VA	O-Ring					
840660N	Fendt	Schlepper / Farmer 200	260P	O-Ring					
840660N	Fendt	Schlepper / Farmer 200	260PA	O-Ring					

Dasis Nr.	Hersteller	Modell	Typ	Spezifikation	Innengewindemaß Druckseite	Innengewindemaß Saugseite	Außengewindemaß Druckseite	Außengewindemaß Saugseite	Kapillarrohrlänge [mm]
840490N	Fendt	Schlepper / Farmer 200	260S	O-Ring			16,0	18,0	355
840490N	Fendt	Schlepper / Farmer 200	260SA	O-Ring			16,0	18,0	355
840660N	Fendt	Schlepper / Farmer 200	260V	O-Ring					
840660N	Fendt	Schlepper / Farmer 200	260VA	O-Ring					
840660N	Fendt	Schlepper / Farmer 200	270P	O-Ring					
840660N	Fendt	Schlepper / Farmer 200	270PA	O-Ring					
840660N	Fendt	Schlepper / Farmer 200	270V	O-Ring					
840660N	Fendt	Schlepper / Farmer 200	270VA	O-Ring					
840660N	Fendt	Schlepper / Farmer 200	275SA	O-Ring					
840490N	Fendt	Schlepper / Farmer 200	275SA	O-Ring			16,0	18,0	355
840660N	Fendt	Schlepper / Farmer 200	275V	O-Ring					
840660N	Fendt	Schlepper / Farmer 200	275VA	O-Ring					
840660N	Fendt	Schlepper / Farmer 200	280P	O-Ring					
840660N	Fendt	Schlepper / Farmer 200	280PA	O-Ring					
840660N	Fendt	Schlepper / Farmer 200	280S	O-Ring					
840490N	Fendt	Schlepper / Farmer 200	280S	O-Ring			16,0	18,0	355
840660N	Fendt	Schlepper / Farmer 200	280SA	O-Ring					
840490N	Fendt	Schlepper / Farmer 200	280SA	O-Ring			16,0	18,0	355
840660N	Fendt	Schlepper / Farmer 200	280VA	O-Ring					
840086N	Fendt	Schlepper / Farmer 300	303LS	Innengewinde					
840086N	Fendt	Schlepper / Farmer 300	303LSA	Innengewinde					

Dasis Nr.	Hersteller	Modell	Typ	Spezifikation	Innengewindemaß Druckseite	Innengewindemaß Saugseite	Außengewindemaß Druckseite	Außengewindemaß Saugseite	Kapillarrohrlänge [mm]
840086N	Fendt	Schlepper / Farmer 300	304LS	Innengewinde					
840086N	Fendt	Schlepper / Farmer 300	304LSA	Innengewinde					
840086N	Fendt	Schlepper / Farmer 300	305LS	Innengewinde					
840086N	Fendt	Schlepper / Farmer 300	305LSA	Innengewinde					
840086N	Fendt	Schlepper / Farmer 300	306LS	Innengewinde					
840086N	Fendt	Schlepper / Farmer 300	306LSA	Innengewinde					
840086N	Fendt	Schlepper / Farmer 300	307	Innengewinde					
840660N	Fendt	Schlepper / Farmer 300	307LS	O-Ring					
840086N	Fendt	Schlepper / Farmer 300	307LS	Innengewinde					
840086N	Fendt	Schlepper / Farmer 300	307LSA	Innengewinde					
840660N	Fendt	Schlepper / Farmer 300	307LSA	O-Ring					
840086N	Fendt	Schlepper / Farmer 300	307LSE	Innengewinde					
840660N	Fendt	Schlepper / Farmer 300	307LSE	O-Ring					
840086N	Fendt	Schlepper / Farmer 300	308	Innengewinde					
840660N	Fendt	Schlepper / Farmer 300	308LS	O-Ring					
840086N	Fendt	Schlepper / Farmer 300	308LS	Innengewinde					
840660N	Fendt	Schlepper / Farmer 300	308LSA	O-Ring					
840086N	Fendt	Schlepper / Farmer 300	308LSA	Innengewinde					
840660N	Fendt	Schlepper / Farmer 300	308LSE	O-Ring					
840086N	Fendt	Schlepper / Farmer 300	308LSE	Innengewinde					
840086N	Fendt	Schlepper / Farmer 300	309	Innengewinde					

Dasis Nr.	Hersteller	Modell	Typ	Spezifikation	Innengewindemaß Druckseite	Innengewindemaß Saugseite	Außengewindemaß Druckseite	Außengewindemaß Saugseite	Kapillarrohrlänge [mm]
840086N	Fendt	Schlepper / Farmer 300	309LS	Innengewinde					
840086N	Fendt	Schlepper / Farmer 300	309LSA	Innengewinde					
840086N	Fendt	Schlepper / Farmer 300	309LSE	Innengewinde					
840086N	Fendt	Schlepper / Farmer 300	310LSA	Innengewinde					
840086N	Fendt	Schlepper / Farmer 300	310LSE	Innengewinde					
840086N	Fendt	Schlepper / Farmer 300	311LSA	Innengewinde					
840086N	Fendt	Schlepper / Farmer 300	311LSE	Innengewinde					
840086N	Fendt	Schlepper / Farmer 300	312LSA	Innengewinde					
840086N	Fendt	Schlepper / Farmer 300	312LSE	Innengewinde					
840660N	Fendt	Schlepper / Farmer 400	409	O-Ring					
840660N	Fendt	Schlepper / Farmer 400	410	O-Ring					
840660N	Fendt	Schlepper / Farmer 400	411	O-Ring					
840660N	Fendt	Schlepper / Farmer 400	412	O-Ring					
840660N	Fendt	Schlepper / Favorit 500	509	O-Ring					
840660N	Fendt	Schlepper / Favorit 500	510	O-Ring					
840660N	Fendt	Schlepper / Favorit 500	511	O-Ring					
840660N	Fendt	Schlepper / Favorit 500	512	O-Ring					
840660N	Fendt	Schlepper / Favorit 500	514	O-Ring					
840660N	Fendt	Schlepper / Favorit 500	515	O-Ring					
840660N	Fendt	Schlepper / Favorit 700	711	O-Ring					
840660N	Fendt	Schlepper / Favorit 700	712	O-Ring					



Dasis Nr.	Hersteller	Modell	Typ	Spezifikation	Innengewindemaß Druckseite	Innengewindemaß Saugseite	Außengewindemaß Druckseite	Außengewindemaß Saugseite	Kapillarrohrlänge [mm]
840660N	Fendt	Schlepper / Favorit 700	714	O-Ring					
840660N	Fendt	Schlepper / Favorit 700	716	O-Ring					
840086N	Fendt	Schlepper / Favorit 800	815	Innengewinde					
840660N	Fendt	Schlepper / Favorit 800	815	O-Ring					
840086N	Fendt	Schlepper / Favorit 800	816	Innengewinde					
840660N	Fendt	Schlepper / Favorit 800	816	O-Ring					
840660N	Fendt	Schlepper / Favorit 800	817	O-Ring					
840086N	Fendt	Schlepper / Favorit 800	817	Innengewinde					
840660N	Fendt	Schlepper / Favorit 800	818	O-Ring					
840086N	Fendt	Schlepper / Favorit 800	818	Innengewinde					
840019N	Fendt	Schlepper / Favorit 800	822						
840019N	Fendt	Schlepper / Favorit 800	824						
840019N	Fendt	Schlepper / Favorit 800	826						
840019N	Fendt	Schlepper / Favorit 800	828						
840660N	Fendt	Schlepper / Favorit 900	916	O-Ring					
840660N	Fendt	Schlepper / Favorit 900	918	O-Ring					
840660N	Fendt	Schlepper / Favorit 900	920	O-Ring					
840019N	Fendt	Schlepper / Favorit 900	922						
840660N	Fendt	Schlepper / Favorit 900	924	O-Ring					
840019N	Fendt	Schlepper / Favorit 900	924						
840660N	Fendt	Schlepper / Favorit 900	926	O-Ring					

Dasis Nr.	Hersteller	Modell	Typ	Spezifikation	Innengewindemaß Druckseite	Innengewindemaß Saugseite	Außengewindemaß Druckseite	Außengewindemaß Saugseite	Kapillarrohrlänge [mm]
840660N	Fendt	Schlepper / Favorit 900	926PL	O-Ring					
840019N	Fendt	Schlepper / Favorit 900	927						
840019N	Fendt	Schlepper / Favorit 900	930						
840660N	Fendt	Schlepper / Favorit 900	930	O-Ring					
840019N	Fendt	Schlepper / Favorit 900	933						
840019N	Fendt	Schlepper / Favorit 900	936						
840019N	Fendt	Schlepper / Favorit 900	939						
840290N	Fendt	Schlepper / GT300	390	Innengewinde					
840290N	Fendt	Schlepper / GT300	395	Innengewinde					
840290N	Fendt	Schlepper / GT300	A390	Innengewinde					
840290N	Fendt	Schlepper / GT300	A395	Innengewinde					
840660N	Fendt	Schlepper / Xylon	520	O-Ring					
840660N	Fendt	Schlepper / Xylon	522	O-Ring					
840660N	Fendt	Schlepper / Xylon	524	O-Ring					
840086N	Fiat / Hitachi	Feldhäcksler ....-70	670	Innengewinde					
840086N	Fiat / Hitachi	Feldhäcksler ....-70	8670	Innengewinde					
840086N	Fiat / Hitachi	Feldhäcksler ....-70	8770	Innengewinde					
840086N	Fiat / Hitachi	Feldhäcksler ....-70	8870	Innengewinde					
840086N	Fiat / Hitachi	Feldhäcksler ....-70	8970	Innengewinde					
840490N	Fiat / Hitachi	Schlepper ....-80	580	O-Ring			16,0	18,0	355
840490N	Fiat / Hitachi	Schlepper ....-80	580DT	O-Ring			16,0	18,0	355
840490N	Fiat / Hitachi	Schlepper ....-80	580T	O-Ring			16,0	18,0	355
840490N	Fiat / Hitachi	Schlepper ....-80	680	O-Ring			16,0	18,0	355
840490N	Fiat / Hitachi	Schlepper ....-80	680DT	O-Ring			16,0	18,0	355
840490N	Fiat / Hitachi	Schlepper ....-80	680T	O-Ring			16,0	18,0	355
840490N	Fiat / Hitachi	Schlepper ....-80	780	O-Ring			16,0	18,0	355
840490N	Fiat / Hitachi	Schlepper ....-80	780DT	O-Ring			16,0	18,0	355
840490N	Fiat / Hitachi	Schlepper ....-80	780T	O-Ring			16,0	18,0	355

Dasis Nr.	Hersteller	Modell	Typ	Spezifikation	Innengewindemaß Druckseite	Innengewindemaß Saugseite	Außengewindemaß Druckseite	Außengewindemaß Saugseite	Kapillarrohrlänge [mm]
840490N	Fiat / Hitachi	Schlepper ....-80	880	O-Ring			16,0	18,0	355
840490N	Fiat / Hitachi	Schlepper ....-80	880-5	O-Ring			16,0	18,0	355
840490N	Fiat / Hitachi	Schlepper ....-80	880-5T	O-Ring			16,0	18,0	355
840490N	Fiat / Hitachi	Schlepper ....-80	880DT	O-Ring			16,0	18,0	355
840490N	Fiat / Hitachi	Schlepper ....-80	880T	O-Ring			16,0	18,0	355
840490N	Fiat / Hitachi	Schlepper ....-80	980	O-Ring			16,0	18,0	355
840490N	Fiat / Hitachi	Schlepper ....-80	980DT	O-Ring			16,0	18,0	355
840490N	Fiat / Hitachi	Schlepper ....-80	980T	O-Ring			16,0	18,0	355
840490N	Fiat / Hitachi	Schlepper ....-80	1180DT	O-Ring			16,0	18,0	355
840490N	Fiat / Hitachi	Schlepper ....-80	1180T	O-Ring			16,0	18,0	355
840490N	Fiat / Hitachi	Schlepper ....-80	1280	O-Ring			16,0	18,0	355
840490N	Fiat / Hitachi	Schlepper ....-80	1280DT	O-Ring			16,0	18,0	355
840490N	Fiat / Hitachi	Schlepper ....-80	1280T	O-Ring			16,0	18,0	355
840490N	Fiat / Hitachi	Schlepper ....-80	1380	O-Ring			16,0	18,0	355
840490N	Fiat / Hitachi	Schlepper ....-80	1380DT	O-Ring			16,0	18,0	355
840490N	Fiat / Hitachi	Schlepper ....-80	1380T	O-Ring			16,0	18,0	355
840490N	Fiat / Hitachi	Schlepper ....-80	1580	O-Ring			16,0	18,0	355
840490N	Fiat / Hitachi	Schlepper ....-80	1580DT	O-Ring			16,0	18,0	355
840490N	Fiat / Hitachi	Schlepper ....-80	1580DTTurbo	O-Ring			16,0	18,0	355
840490N	Fiat / Hitachi	Schlepper ....-80	1580T	O-Ring			16,0	18,0	355
840490N	Fiat / Hitachi	Schlepper ....-80	1580Turbo	O-Ring			16,0	18,0	355
840490N	Fiat / Hitachi	Schlepper ....-80	1880	O-Ring			16,0	18,0	355
840490N	Fiat / Hitachi	Schlepper ....-80	1880DT	O-Ring			16,0	18,0	355
840490N	Fiat / Hitachi	Schlepper ....-80	1880T	O-Ring			16,0	18,0	355
840490N	Fiat / Hitachi	Schlepper ....-90	55-90DT	O-Ring			16,0	18,0	355
840490N	Fiat / Hitachi	Schlepper ....-90	60-90DT	O-Ring			16,0	18,0	355
840490N	Fiat / Hitachi	Schlepper ....-90	65-90DT	O-Ring			16,0	18,0	355
840490N	Fiat / Hitachi	Schlepper ....-90	70-90DT	O-Ring			16,0	18,0	355
840490N	Fiat / Hitachi	Schlepper ....-90	80-90DT	O-Ring			16,0	18,0	355
840490N	Fiat / Hitachi	Schlepper ....-90	85-90DT	O-Ring			16,0	18,0	355
840490N	Fiat / Hitachi	Schlepper ....-90	90-90DT	O-Ring			16,0	18,0	355

Dasis Nr.	Hersteller	Modell	Typ	Spezifikation	Innengewindemaß Druckseite	Innengewindemaß Saugseite	Außengewindemaß Druckseite	Außengewindemaß Saugseite	Kapillarrohrlänge [mm]
840490N	Fiat / Hitachi	Schlepper ....-90	95-90DT	O-Ring			16,0	18,0	355
840490N	Fiat / Hitachi	Schlepper ....-90	100-90DT	O-Ring			16,0	18,0	355
840490N	Fiat / Hitachi	Schlepper ....-90	110-90DT	O-Ring			16,0	18,0	355
840490N	Fiat / Hitachi	Schlepper ....-90	115-90DT	O-Ring			16,0	18,0	355
840490N	Fiat / Hitachi	Schlepper ....-90	130-90	O-Ring			16,0	18,0	355
840490N	Fiat / Hitachi	Schlepper ....-90	130-90DT	O-Ring			16,0	18,0	355
840490N	Fiat / Hitachi	Schlepper ....-90	140-90	O-Ring			16,0	18,0	355
840490N	Fiat / Hitachi	Schlepper ....-90	140-90DT	O-Ring			16,0	18,0	355
840490N	Fiat / Hitachi	Schlepper ....-90	160-90	O-Ring			16,0	18,0	355
840490N	Fiat / Hitachi	Schlepper ....-90	160-90DT	O-Ring			16,0	18,0	355
840490N	Fiat / Hitachi	Schlepper ....-90	180-90	O-Ring			16,0	18,0	355
840490N	Fiat / Hitachi	Schlepper ....-90	180-90DT	O-Ring			16,0	18,0	355
840490N	Fiat / Hitachi	Schlepper ....-94	60-94	O-Ring			16,0	18,0	355
840490N	Fiat / Hitachi	Schlepper ....-94	60-94DT	O-Ring			16,0	18,0	355
840490N	Fiat / Hitachi	Schlepper ....-94	65-94	O-Ring			16,0	18,0	355
840490N	Fiat / Hitachi	Schlepper ....-94	65-94DT	O-Ring			16,0	18,0	355
840490N	Fiat / Hitachi	Schlepper ....-94	72-94	O-Ring			16,0	18,0	355
840490N	Fiat / Hitachi	Schlepper ....-94	72-94DT	O-Ring			16,0	18,0	355
840490N	Fiat / Hitachi	Schlepper ....-94	82-94	O-Ring			16,0	18,0	355
840490N	Fiat / Hitachi	Schlepper ....-94	82-94DT	O-Ring			16,0	18,0	355
840490N	Fiat / Hitachi	Schlepper ....-94	88-94	O-Ring			16,0	18,0	355
840490N	Fiat / Hitachi	Schlepper ....-94	88-94DT	O-Ring			16,0	18,0	355
840490N	Fiat / Hitachi	Schlepper ....-94	95-94DT	O-Ring			16,0	18,0	355
840490N	Fiat / Hitachi	Schlepper / F	100	O-Ring			16,0	18,0	355
840490N	Fiat / Hitachi	Schlepper / F	110	O-Ring			16,0	18,0	355
840490N	Fiat / Hitachi	Schlepper / F	115	O-Ring			16,0	18,0	355
840490N	Fiat / Hitachi	Schlepper / F	120	O-Ring			16,0	18,0	355
840490N	Fiat / Hitachi	Schlepper / F	120DT	O-Ring			16,0	18,0	355
840490N	Fiat / Hitachi	Schlepper / F	130	O-Ring			16,0	18,0	355
840490N	Fiat / Hitachi	Schlepper / F	130DT	O-Ring			16,0	18,0	355
840490N	Fiat / Hitachi	Schlepper / F	140	O-Ring			16,0	18,0	355

Dasis Nr.	Hersteller	Modell	Typ	Spezifikation	Innengewindemaß Druckseite	Innengewindemaß Saugseite	Außengewindemaß Druckseite	Außengewindemaß Saugseite	Kapillarrohrlänge [mm]
840490N	Fiat / Hitachi	Schlepper / F	140DT	O-Ring			16,0	18,0	355
840086N	Fiat / Hitachi	Schlepper / G	170	Innengewinde					
840086N	Fiat / Hitachi	Schlepper / G	190	Innengewinde					
840086N	Fiat / Hitachi	Schlepper / G	210	Innengewinde					
840086N	Fiat / Hitachi	Schlepper / G	240	Innengewinde					
840490N	Fiat / Hitachi	Schlepper / L	60	O-Ring			16,0	18,0	355
840490N	Fiat / Hitachi	Schlepper / L	65	O-Ring			16,0	18,0	355
840490N	Fiat / Hitachi	Schlepper / L	75	O-Ring			16,0	18,0	355
840490N	Fiat / Hitachi	Schlepper / L	85	O-Ring			16,0	18,0	355
840490N	Fiat / Hitachi	Schlepper / L	95	O-Ring			16,0	18,0	355
840166N	Fiat / Hitachi	Schlepper / M	100	O-Ring					
840166N	Fiat / Hitachi	Schlepper / M	115	O-Ring					
840166N	Fiat / Hitachi	Schlepper / M	135	O-Ring					
840166N	Fiat / Hitachi	Schlepper / M	160	O-Ring					
840166N	Fiat / Hitachi	Schlepper / M	180	O-Ring					
840303N	Hitachi	Zaxis	200						
840303N	Hitachi	Zaxis	210						
840303N	Hitachi	Zaxis	220						
840303N	Hitachi	Zaxis	230						
840303N	Hitachi	Zaxis	240						
840303N	Hitachi	Zaxis	250						
840303N	Hitachi	Zaxis	330						
840303N	Hitachi	Zaxis	350						
840303N	Hitachi	Zaxis	370						
840130N	JCB	Bagger 360 ° / 800	802	O-Ring					
840130N	JCB	Bagger 360 ° / 800	804	O-Ring					
840130N	JCB	Bagger 360 ° / 800	805	O-Ring					
840130N	JCB	Bagger 360 ° / 800	806	O-Ring					
840130N	JCB	Bagger 360 ° / 800	807	O-Ring					
840130N	JCB	Bagger 360 ° / 800	808	O-Ring					
840130N	JCB	Bagger 360 ° / 800	811	O-Ring					

Dasis Nr.	Hersteller	Modell	Typ	Spezifikation	Innengewindemaß Druckseite	Innengewindemaß Saugseite	Außengewindemaß Druckseite	Außengewindemaß Saugseite	Kapillarrohrlänge [mm]
840130N	JCB	Bagger 360 ° / 800	812	O-Ring					
840130N	JCB	Bagger 360 ° / 800	814	O-Ring					
840130N	JCB	Bagger 360 ° / JS	130	O-Ring					
840130N	JCB	Bagger 360 ° / JS	130VV	O-Ring					
840130N	JCB	Bagger 360 ° / JS	130VV-P	O-Ring					
840130N	JCB	Bagger 360 ° / JS	145VV	O-Ring					
840130N	JCB	Bagger 360 ° / JS	150VV	O-Ring					
840130N	JCB	Bagger 360 ° / JS	160	O-Ring					
840130N	JCB	Bagger 360 ° / JS	160VV	O-Ring					
840130N	JCB	Bagger 360 ° / JS	160VV-P	O-Ring					
840130N	JCB	Bagger 360 ° / JS	175VV	O-Ring					
840130N	JCB	Bagger 360 ° / JS	180	O-Ring					
840130N	JCB	Bagger 360 ° / JS	200	O-Ring					
840130N	JCB	Bagger 360 ° / JS	200W	O-Ring					
840130N	JCB	Bagger 360 ° / JS	200W-P	O-Ring					
840130N	JCB	Bagger 360 ° / JS	210	O-Ring					
840130N	JCB	Bagger 360 ° / JS	220	O-Ring					
840130N	JCB	Bagger 360 ° / JS	240	O-Ring					
840130N	JCB	Bagger 360 ° / JS	260	O-Ring					
840130N	JCB	Bagger 360 ° / JS	330	O-Ring					
840370N	JCB	Baggerlader	RTFL				16	18	
840130N	JCB	Schlepper / Fastrac 100	125	O-Ring					
840130N	JCB	Schlepper / Fastrac 100	130	O-Ring					
840130N	JCB	Schlepper / Fastrac 100	135	O-Ring					
840130N	JCB	Schlepper / Fastrac 100	145	O-Ring					
840130N	JCB	Schlepper / Fastrac 100	150	O-Ring					
840130N	JCB	Schlepper / Fastrac 100	155	O-Ring					
840130N	JCB	Schlepper / Fastrac 100	185	O-Ring					

Dasis Nr.	Hersteller	Modell	Typ	Spezifikation	Innengewindemaß Druckseite	Innengewindemaß Saugseite	Außengewindemaß Druckseite	Außengewindemaß Saugseite	Kapillarrohrlänge [mm]
840380N	JCB	Schlepper / Fastrac 2000	2000						
840380N	JCB	Schlepper / Fastrac 2000	2115						
840380N	JCB	Schlepper / Fastrac 2000	2125						
840380N	JCB	Schlepper / Fastrac 2000	2135						
840380N	JCB	Schlepper / Fastrac 2000	2150						
840130N	JCB	Teleskopklader / 500 Serie	504B	O-Ring					
840130N	JCB	Teleskopklader / 500 Serie	506B	O-Ring					
840130N	JCB	Teleskopklader / 500 Serie	506C	O-Ring					
840130N	JCB	Teleskopklader / 500 Serie	506CHL	O-Ring					
840130N	JCB	Teleskopklader / 500 Serie	506HL	O-Ring					
840130N	JCB	Teleskopklader / 500 Serie	508C	O-Ring					
840130N	JCB	Teleskopklader / 500 Serie	520	O-Ring					
840165N	JCB	Teleskopklader / 500 Serie	520HL						
840165N	JCB	Teleskopklader / 500 Serie	520M						
840165N	JCB	Teleskopklader / 500 Serie	520S						
840165N	JCB	Teleskopklader / 500 Serie	525						
840165N	JCB	Teleskopklader / 500 Serie	525B						
840130N	JCB	Teleskopklader / 500 Serie	525HL	O-Ring					
840130N	JCB	Teleskopklader / 500 Serie	526	O-Ring					
840130N	JCB	Teleskopklader / 500 Serie	526S	O-Ring					
840130N	JCB	Teleskopklader / 500 Serie	528AG	O-Ring					

Dasis Nr.	Hersteller	Modell	Typ	Spezifikation	Innengewindemaß Druckseite	Innengewindemaß Saugseite	Außengewindemaß Druckseite	Außengewindemaß Saugseite	Kapillarrohrlänge [mm]
840130N	JCB	Teleskopklader / 500 Serie	528S	O-Ring					
840130N	JCB	Teleskopklader / 500 Serie	530	O-Ring					
840130N	JCB	Teleskopklader / 500 Serie	530B	O-Ring					
840130N	JCB	Teleskopklader / 500 Serie	530BHL	O-Ring					
840130N	JCB	Teleskopklader / 500 Serie	530FS	O-Ring					
840130N	JCB	Teleskopklader / 500 Serie	530FSSUPER	O-Ring					
840130N	JCB	Teleskopklader / 500 Serie	530HL	O-Ring					
840130N	JCB	Teleskopklader / 500 Serie	530S	O-Ring					
840130N	JCB	Teleskopklader / 500 Serie	530SUPERAG	O-Ring					
840130N	JCB	Teleskopklader / 500 Serie	530S XL	O-Ring					
840130N	JCB	Teleskopklader / 500 Serie	531S	O-Ring					
840130N	JCB	Teleskopklader / 500 Serie	532	O-Ring					
840130N	JCB	Teleskopklader / 500 Serie	532H	O-Ring					
840130N	JCB	Teleskopklader / 500 Serie	535	O-Ring					
840130N	JCB	Teleskopklader / 500 Serie	537	O-Ring					
840130N	JCB	Teleskopklader / 500 Serie	537H	O-Ring					
840130N	JCB	Teleskopklader / 500 Serie	540	O-Ring					
840130N	JCB	Teleskopklader / 500 Serie	540B	O-Ring					
840130N	JCB	Teleskopklader / 500 Serie	540BM	O-Ring					
840130N	JCB	Teleskopklader / 500 Serie	540FS	O-Ring					
840130N	JCB	Teleskopklader / 500 Serie	540FSPlus	O-Ring					



Dasis Nr.	Hersteller	Modell	Typ	Spezifikation	Innengewindemaß Druckseite	Innengewindemaß Saugseite	Außengewindemaß Druckseite	Außengewindemaß Saugseite	Kapillarrohrlänge [mm]
840130N	JCB	Teleskoplader / 500 Serie	540FSSUPER	O-Ring					
840130N	JCB	Teleskoplader / 500 Serie	540S	O-Ring					
840130N	JCB	Teleskoplader / 500 Serie	540SUPERAG	O-Ring					
840130N	JCB	Teleskoplader / 500 Serie	540S XL	O-Ring					
840130N	JCB	Teleskoplader / 500 Serie	550	O-Ring					
840130N	JCB	Teleskoplader / 500 Serie	5508	O-Ring					
840086N	JCB	Teleskoplader / Fastrac 3000	3155	Innengewinde					
840086N	JCB	Teleskoplader / Fastrac 3000	3185	Innengewinde					
840086N	JCB	Teleskoplader / Fastrac 3000	3190	Innengewinde					
840086N	JCB	Teleskoplader / Fastrac 3000	3220	Innengewinde					
840303N	John Deere	Baggerlader / 110-726B	230CLC						
840303N	John Deere	Baggerlader / 110-726B	270CLC						
840086N	John Deere	Baggerlader / 110-726B	300	Innengewinde					
840157N	John Deere	Baggerlader / 110-726B	300	O-Ring					
840157N	John Deere	Baggerlader / 110-726B	310	O-Ring					
840086N	John Deere	Baggerlader / 110-726B	310	Innengewinde					
840157N	John Deere	Baggerlader / 110-726B	310E	O-Ring					
840163N	John Deere	Baggerlader / 110-726B	310G	O-Ring	3/8 / 1/2	5/8 / 3/4			
840157N	John Deere	Baggerlader / 110-726B	310SE	O-Ring					
840157N	John Deere	Baggerlader / 110-726B	310SG	O-Ring					
840157N	John Deere	Baggerlader / 110-726B	315	O-Ring					

Dasis Nr.	Hersteller	Modell	Typ	Spezifikation	Innengewindemaß Druckseite	Innengewindemaß Saugseite	Außengewindemaß Druckseite	Außengewindemaß Saugseite	Kapillarrohrlänge [mm]
840086N	John Deere	Baggerlader / 110-726B	315	Innengewinde					
840163N	John Deere	Baggerlader / 110-726B	315SG	O-Ring	3/8 / 1/2	5/8 / 3/4			
840303N	John Deere	Baggerlader / 110-726B	330CLC						
840086N	John Deere	Baggerlader / 110-726B	410	Innengewinde					
840157N	John Deere	Baggerlader / 110-726B	410	O-Ring					
840157N	John Deere	Baggerlader / 110-726B	410E	O-Ring					
840086N	John Deere	Baggerlader / 110-726B	410E	Innengewinde					
840163N	John Deere	Baggerlader / 110-726B	410G	O-Ring	3/8 / 1/2	5/8 / 3/4			
840086N	John Deere	Baggerlader / 110-726B	510	Innengewinde					
840157N	John Deere	Baggerlader / 110-726B	510	O-Ring					
840163N	John Deere	Baggerlader / 110-726B	544J	O-Ring	3/8 / 1/2	5/8 / 3/4			
840086N	John Deere	Baggerlader / 110-726B	624G	Innengewinde					
840086N	John Deere	Baggerlader / 110-726B	710	Innengewinde					
840050N	John Deere	Baggerlader / 110-726B	710	Konus			13,0	16,0	480
840039N	John Deere	Feldhäcksler / 3400-3420	3400	Flansch					
840039N	John Deere	Feldhäcksler / 3400-3420	3415	Flansch					
840039N	John Deere	Feldhäcksler / 3400-3420	3420	Flansch					
840048N	John Deere	Feldhäcksler / 5030-5730	5200	Flansch					
840048N	John Deere	Feldhäcksler / 5030-5730	5400	Flansch					
840084N	John Deere	Feldhäcksler / 5030-5730	5720				16	18	305
840084N	John Deere	Feldhäcksler / 5030-5730	5730				16	18	305

Dasis Nr.	Hersteller	Modell	Typ	Spezifikation	Innengewindemaß Druckseite	Innengewindemaß Saugseite	Außengewindemaß Druckseite	Außengewindemaß Saugseite	Kapillarrohrlänge [mm]
840048N	John Deere	Feldhäcksler / 6010-6950	6610	Flansch					
840048N	John Deere	Feldhäcksler / 6010-6950	6650	Flansch					
840084N	John Deere	Feldhäcksler / 6010-6950	6670				16	18	305
840048N	John Deere	Feldhäcksler / 6010-6950	6710	Flansch					
840048N	John Deere	Feldhäcksler / 6010-6950	6750	Flansch					
840048N	John Deere	Feldhäcksler / 6010-6950	6810	Flansch					
840048N	John Deere	Feldhäcksler / 6010-6950	6850	Flansch					
840048N	John Deere	Feldhäcksler / 6010-6950	6910	Flansch					
840048N	John Deere	Feldhäcksler / 6010-6950	6950	Flansch					
840084N	John Deere	Mähdrescher / 900-1188	1052				16	18	305
840084N	John Deere	Mähdrescher / 900-1188	1055				16	18	305
840084N	John Deere	Mähdrescher / 900-1188	1065				16	18	305
840084N	John Deere	Mähdrescher / 900-1188	1068H				16	18	305
840084N	John Deere	Mähdrescher / 900-1188	1072				16	18	305
840084N	John Deere	Mähdrescher / 900-1188	1075				16	18	305
840084N	John Deere	Mähdrescher / 900-1188	1075H4				16	18	305
840084N	John Deere	Mähdrescher / 900-1188	1085				16	18	305
840084N	John Deere	Mähdrescher / 900-1188	1085H4				16	18	305
840084N	John Deere	Mähdrescher / 900-1188	1155				16	18	305
840084N	John Deere	Mähdrescher / 900-1188	1157				16	18	305
840084N	John Deere	Mähdrescher / 900-1188	1158				16	18	305

Dasis Nr.	Hersteller	Modell	Typ	Spezifikation	Innengewindemaß Druckseite	Innengewindemaß Saugseite	Außengewindemaß Druckseite	Außengewindemaß Saugseite	Kapillarrohrlänge [mm]
840084N	John Deere	Mähdrescher / 900-1188	1166				16	18	305
840084N	John Deere	Mähdrescher / 900-1188	1169				16	18	305
840084N	John Deere	Mähdrescher / 900-1188	1169H				16	18	305
840084N	John Deere	Mähdrescher / 900-1188	1169H4				16	18	305
840048N	John Deere	Mähdrescher / 900-1188	1170	Flansch					
840084N	John Deere	Mähdrescher / 900-1188	1170				16	18	305
840084N	John Deere	Mähdrescher / 900-1188	1174				16	18	305
840084N	John Deere	Mähdrescher / 900-1188	1175				16	18	305
840084N	John Deere	Mähdrescher / 900-1188	1177				16	18	305
840084N	John Deere	Mähdrescher / 900-1188	1177H4				16	18	305
840084N	John Deere	Mähdrescher / 900-1188	1188				16	18	305
840084N	John Deere	Mähdrescher / 900-1188	1188H4				16	18	305
840048N	John Deere	Mähdrescher / 2000-2266	2054	Flansch					
840048N	John Deere	Mähdrescher / 2000-2266	2056	Flansch					
840048N	John Deere	Mähdrescher / 2000-2266	2058	Flansch					
840048N	John Deere	Mähdrescher / 2000-2266	2064	Flansch					
840048N	John Deere	Mähdrescher / 2000-2266	2066	Flansch					
840050N	John Deere	Mähdrescher / 4000-8850	4400	Konus			13,0	16,0	480
840086N	John Deere	Mähdrescher / 4000-8850	4890	Innengewinde					
840086N	John Deere	Mähdrescher / 4000-8850	4895	Innengewinde					
840086N	John Deere	Mähdrescher / 4000-8850	4990	Innengewinde					

Dasis Nr.	Hersteller	Modell	Typ	Spezifikation	Innengewindemaß Druckseite	Innengewindemaß Saugseite	Außengewindemaß Druckseite	Außengewindemaß Saugseite	Kapillarrohrlänge [mm]
840086N	John Deere	Mähdrescher / 4000-8850	4995	Innengewinde					
840050N	John Deere	Mähdrescher / 4000-8850	6600	Konus			13,0	16,0	480
840050N	John Deere	Mähdrescher / 4000-8850	6620	Konus			13,0	16,0	480
840050N	John Deere	Mähdrescher / 4000-8850	6622	Konus			13,0	16,0	480
840086N	John Deere	Mähdrescher / 4000-8850	7455	Innengewinde					
840084N	John Deere	Mähdrescher / 4000-8850	7700				16	18	305
840050N	John Deere	Mähdrescher / 4000-8850	7700	Konus			13,0	16,0	480
840084N	John Deere	Mähdrescher / 4000-8850	7720				16	18	305
840050N	John Deere	Mähdrescher / 4000-8850	7720	Konus			13,0	16,0	480
840084N	John Deere	Mähdrescher / 4000-8850	7722				16	18	305
840050N	John Deere	Mähdrescher / 4000-8850	7722	Konus			13,0	16,0	480
840084N	John Deere	Mähdrescher / 4000-8850	8820				16	18	305
840050N	John Deere	Mähdrescher / 4000-8850	8820	Konus			13,0	16,0	480
840086N	John Deere	Mähdrescher / 9000-9980	9150	Innengewinde					
840086N	John Deere	Mähdrescher / 9000-9980	9400	Innengewinde					
840086N	John Deere	Mähdrescher / 9000-9980	9410	Innengewinde					
840086N	John Deere	Mähdrescher / 9000-9980	9450	Innengewinde					
840086N	John Deere	Mähdrescher / 9000-9980	9500	Innengewinde					
840086N	John Deere	Mähdrescher / 9000-9980	9510	Innengewinde					
840086N	John Deere	Mähdrescher / 9000-9980	9540	Innengewinde					
840086N	John Deere	Mähdrescher / 9000-9980	9550	Innengewinde					

Dasis Nr.	Hersteller	Modell	Typ	Spezifikation	Innengewindemaß Druckseite	Innengewindemaß Saugseite	Außengewindemaß Druckseite	Außengewindemaß Saugseite	Kapillarrohrlänge [mm]
840086N	John Deere	Mähdrescher / 9000-9980	9560	Innengewinde					
840086N	John Deere	Mähdrescher / 9000-9980	9600	Innengewinde					
840086N	John Deere	Mähdrescher / 9000-9980	9640	Innengewinde					
840086N	John Deere	Mähdrescher / 9000-9980	9650	Innengewinde					
840086N	John Deere	Mähdrescher / 9000-9980	9930	Innengewinde					
840086N	John Deere	Mähdrescher / 9000-9980	9950	Innengewinde					
840086N	John Deere	Mähdrescher / 9000-9980	9960	Innengewinde					
840086N	John Deere	Mähdrescher / 9000-9980	9980	Innengewinde					
840086N	John Deere	Mähdrescher / CTS	CTS	Innengewinde					
840123N	John Deere	Minibagger / 200-800	240						
840123N	John Deere	Minibagger / 200-800	250						
840123N	John Deere	Minibagger / 200-800	260						
840123N	John Deere	Minibagger / 200-800	270						
840123N	John Deere	Minibagger / 200-800	280						
840123N	John Deere	Minibagger / 200-800	317						
840123N	John Deere	Minibagger / 200-800	320						
840123N	John Deere	Minibagger / 200-800	325						
840123N	John Deere	Minibagger / 200-800	328						
840163N	John Deere	Minibagger / 200-800	360	O-Ring	3/8 / 1/2	5/8 / 3/4			
840163N	John Deere	Minibagger / 200-800	460	O-Ring	3/8 / 1/2	5/8 / 3/4			
840086N	John Deere	Minibagger / 200-800	531S	Innengewinde					
840086N	John Deere	Minibagger / 200-800	540E	Innengewinde					

Dasis Nr.	Hersteller	Modell	Typ	Spezifikation	Innengewindemaß Druckseite	Innengewindemaß Saugseite	Außengewindemaß Druckseite	Außengewindemaß Saugseite	Kapillarrohrlänge [mm]
840086N	John Deere	Minibagger / 200-800	540G	Innengewinde					
840086N	John Deere	Minibagger / 200-800	548E	Innengewinde					
840086N	John Deere	Minibagger / 200-800	640E	Innengewinde					
840086N	John Deere	Minibagger / 200-800	640G	Innengewinde					
840086N	John Deere	Minibagger / 200-800	648E	Innengewinde					
840086N	John Deere	Minibagger / 200-800	740E	Innengewinde					
840086N	John Deere	Minibagger / 200-800	740G	Innengewinde					
840084N	John Deere	Minibagger / 200-800	855				16	18	305
840157N	John Deere	Motorgrader / 400-800	670	O-Ring					
840163N	John Deere	Motorgrader / 400-800	670	O-Ring	3/8 / 1/2	5/8 / 3/4			
840157N	John Deere	Motorgrader / 400-800	670B	O-Ring					
840157N	John Deere	Motorgrader / 400-800	670H	O-Ring					
840163N	John Deere	Motorgrader / 400-800	672	O-Ring	3/8 / 1/2	5/8 / 3/4			
840157N	John Deere	Motorgrader / 400-800	672B	O-Ring					
840157N	John Deere	Motorgrader / 400-800	672H	O-Ring					
840163N	John Deere	Motorgrader / 400-800	770	O-Ring	3/8 / 1/2	5/8 / 3/4			
840157N	John Deere	Motorgrader / 400-800	770B	O-Ring					
840157N	John Deere	Motorgrader / 400-800	770BH	O-Ring					
840163N	John Deere	Motorgrader / 400-800	772	O-Ring	3/8 / 1/2	5/8 / 3/4			
840157N	John Deere	Motorgrader / 400-800	772B	O-Ring					
840157N	John Deere	Motorgrader / 400-800	772BH	O-Ring					

Dasis Nr.	Hersteller	Modell	Typ	Spezifikation	Innengewindemaß Druckseite	Innengewindemaß Saugseite	Außengewindemaß Druckseite	Außengewindemaß Saugseite	Kapillarrohrlänge [mm]
840163N	John Deere	Motorgrader / 400-800	870	O-Ring	3/8 / 1/2	5/8 / 3/4			
840086N	John Deere	Muldenkipper / 200-700	748E	Innengewinde					
840157N	John Deere	Raupen Dozer / 400-850	450H	O-Ring					
840157N	John Deere	Raupen Dozer / 400-850	550H	O-Ring					
840157N	John Deere	Raupen Dozer / 400-850	650H	O-Ring					
840084N	John Deere	Raupen Dozer / 400-850	655				16	18	305
840157N	John Deere	Raupen Dozer / 400-850	700H	O-Ring					
840157N	John Deere	Raupen Dozer / 400-850	710	O-Ring					
840157N	John Deere	Raupen Dozer / 400-850	750	O-Ring					
840157N	John Deere	Raupen Dozer / 400-850	750J	O-Ring					
840157N	John Deere	Raupen Dozer / 400-850	850	O-Ring					
840084N	John Deere	Raupen Dozer / 400-850	850				16	18	305
840157N	John Deere	Raupen Dozer / 400-850	850J	O-Ring					
840163N	John Deere	Schaufellader / 400-800 Serie	444J	O-Ring	3/8 / 1/2	5/8 / 3/4			
840086N	John Deere	Schaufellader / 400-800 Serie	544G	Innengewinde					
840086N	John Deere	Schaufellader / 400-800 Serie	4890	Innengewinde					
840086N	John Deere	Schaufellader / 400-800 Serie	4895	Innengewinde					
840086N	John Deere	Schaufellader / 400-800 Serie	4990	Innengewinde					
840086N	John Deere	Schaufellader / 400-800 Serie	4995	Innengewinde					
840157N	John Deere	Schaufellader / 400-800 Serie	T44H	O-Ring					
840163N	John Deere	Schaufellader / 400-800 Serie	T44H	O-Ring	3/8 / 1/2	5/8 / 3/4			



Dasis Nr.	Hersteller	Modell	Typ	Spezifikation	Innengewindemaß Druckseite	Innengewindemaß Saugseite	Außengewindemaß Druckseite	Außengewindemaß Saugseite	Kapillarrohrlänge [mm]
840157N	John Deere	Schaufellader / 400-800 Serie	T54H	O-Ring					
840163N	John Deere	Schaufellader / 400-800 Serie	T54H	O-Ring	3/8 / 1/2	5/8 / 3/4			
840084N	John Deere	Schlepper / 300-955	830				16	18	305
840084N	John Deere	Schlepper / 300-955	840				16	18	305
840084N	John Deere	Schlepper / 300-955	930				16	18	305
840084N	John Deere	Schlepper / 300-955	940				16	18	305
840084N	John Deere	Schlepper / 1000-1950	1030				16	18	305
840084N	John Deere	Schlepper / 1000-1950	1040				16	18	305
840084N	John Deere	Schlepper / 1000-1950	1130				16	18	305
840084N	John Deere	Schlepper / 1000-1950	1140				16	18	305
840084N	John Deere	Schlepper / 1000-1950	1350				16	18	305
840084N	John Deere	Schlepper / 1000-1950	1530				16	18	305
840084N	John Deere	Schlepper / 1000-1950	1550				16	18	305
840084N	John Deere	Schlepper / 1000-1950	1630				16	18	305
840084N	John Deere	Schlepper / 1000-1950	1640				16	18	305
840084N	John Deere	Schlepper / 1000-1950	1750				16	18	305
840084N	John Deere	Schlepper / 1000-1950	1830				16	18	305
840084N	John Deere	Schlepper / 1000-1950	1840				16	18	305
840084N	John Deere	Schlepper / 1000-1950	1850				16	18	305
840084N	John Deere	Schlepper / 1000-1950	1950				16	18	305
840084N	John Deere	Schlepper / 2000-2955	2030				16	18	305
840084N	John Deere	Schlepper / 2000-2955	2040				16	18	305
840084N	John Deere	Schlepper / 2000-2955	2040S				16	18	305

Dasis Nr.	Hersteller	Modell	Typ	Spezifikation	Innengewindemaß Druckseite	Innengewindemaß Saugseite	Außengewindemaß Druckseite	Außengewindemaß Saugseite	Kapillarrohrlänge [mm]
840084N	John Deere	Schlepper / 2000-2955	2130				16	18	305
840084N	John Deere	Schlepper / 2000-2955	2140				16	18	305
840084N	John Deere	Schlepper / 2000-2955	2240				16	18	305
840084N	John Deere	Schlepper / 2000-2955	2250				16	18	305
840084N	John Deere	Schlepper / 2000-2955	2450				16	18	305
840084N	John Deere	Schlepper / 2000-2955	2550				16	18	305
840084N	John Deere	Schlepper / 2000-2955	2650				16	18	305
840084N	John Deere	Schlepper / 2000-2955	2850				16	18	305
840084N	John Deere	Schlepper / 3000-3650	3030				16	18	305
840084N	John Deere	Schlepper / 3000-3650	3040				16	18	305
840084N	John Deere	Schlepper / 3000-3650	3050				16	18	305
840084N	John Deere	Schlepper / 3000-3650	3130				16	18	305
840084N	John Deere	Schlepper / 3000-3650	3140				16	18	305
840084N	John Deere	Schlepper / 3000-3650	3150				16	18	305
840084N	John Deere	Schlepper / 3000-3650	3340				16	18	305
840084N	John Deere	Schlepper / 3000-3650	3350				16	18	305
840084N	John Deere	Schlepper / 3000-3650	3640				16	18	305
840084N	John Deere	Schlepper / 3000-3650	3650				16	18	305
840084N	John Deere	Schlepper / 4000-4955	4040				16	18	305
840084N	John Deere	Schlepper / 4000-4955	4040S				16	18	305
840084N	John Deere	Schlepper / 4000-4955	4050				16	18	305

Dasis Nr.	Hersteller	Modell	Typ	Spezifikation	Innengewindemaß Druckseite	Innengewindemaß Saugseite	Außengewindemaß Druckseite	Außengewindemaß Saugseite	Kapillarrohrlänge [mm]
840084N	John Deere	Schlepper / 4000-4955	4055				16	18	305
840084N	John Deere	Schlepper / 4000-4955	4230				16	18	305
840084N	John Deere	Schlepper / 4000-4955	4240				16	18	305
840084N	John Deere	Schlepper / 4000-4955	4240S				16	18	305
840084N	John Deere	Schlepper / 4000-4955	4250				16	18	305
840084N	John Deere	Schlepper / 4000-4955	4255				16	18	305
840084N	John Deere	Schlepper / 4000-4955	4350				16	18	305
840084N	John Deere	Schlepper / 4000-4955	4430				16	18	305
840084N	John Deere	Schlepper / 4000-4955	4440				16	18	305
840084N	John Deere	Schlepper / 4000-4955	4450				16	18	305
840084N	John Deere	Schlepper / 4000-4955	4455				16	18	305
840084N	John Deere	Schlepper / 4000-4955	4555				16	18	305
840084N	John Deere	Schlepper / 4000-4955	4630				16	18	305
840084N	John Deere	Schlepper / 4000-4955	4640				16	18	305
840084N	John Deere	Schlepper / 4000-4955	4650				16	18	305
840084N	John Deere	Schlepper / 4000-4955	4755				16	18	305
840084N	John Deere	Schlepper / 4000-4955	4840				16	18	305
840084N	John Deere	Schlepper / 4000-4955	4850				16	18	305
840084N	John Deere	Schlepper / 4000-4955	4955				16	18	305
840157N	John Deere	Schlepper / 5000-5820	5200	O-Ring					
840039N	John Deere	Schlepper / 5000-5820	5220	Flansch					

Dasis Nr.	Hersteller	Modell	Typ	Spezifikation	Innengewindemaß Druckseite	Innengewindemaß Saugseite	Außengewindemaß Druckseite	Außengewindemaß Saugseite	Kapillarrohrlänge [mm]
840157N	John Deere	Schlepper / 5000-5820	5300	O-Ring					
840157N	John Deere	Schlepper / 5000-5820	5310	O-Ring					
840039N	John Deere	Schlepper / 5000-5820	5320	Flansch					
840157N	John Deere	Schlepper / 5000-5820	5400	O-Ring					
840157N	John Deere	Schlepper / 5000-5820	5410	O-Ring					
840039N	John Deere	Schlepper / 5000-5820	5420	Flansch					
840157N	John Deere	Schlepper / 5000-5820	5500	O-Ring					
840157N	John Deere	Schlepper / 5000-5820	5510	O-Ring					
840039N	John Deere	Schlepper / 5000-5820	5520	Flansch					
840157N	John Deere	Schlepper / 6000-6930	6010	O-Ring					
840039N	John Deere	Schlepper / 6000-6930	6100	Flansch					
840157N	John Deere	Schlepper / 6000-6930	6110	O-Ring					
840157N	John Deere	Schlepper / 6000-6930	6120	O-Ring					
840039N	John Deere	Schlepper / 6000-6930	6200	Flansch					
840157N	John Deere	Schlepper / 6000-6930	6210	O-Ring					
840039N	John Deere	Schlepper / 6000-6930	6300	Flansch					
840157N	John Deere	Schlepper / 6000-6930	6310	O-Ring					
840039N	John Deere	Schlepper / 6000-6930	6400	Flansch					
840157N	John Deere	Schlepper / 6000-6930	6410	O-Ring					
840039N	John Deere	Schlepper / 6000-6930	6506	Flansch					
840157N	John Deere	Schlepper / 6000-6930	6510	O-Ring					

Dasis Nr.	Hersteller	Modell	Typ	Spezifikation	Innengewindemaß Druckseite	Innengewindemaß Saugseite	Außengewindemaß Druckseite	Außengewindemaß Saugseite	Kapillarrohrlänge [mm]
840039N	John Deere	Schlepper / 6000-6930	6600	Flansch					
840157N	John Deere	Schlepper / 6000-6930	6610	O-Ring					
840039N	John Deere	Schlepper / 6000-6930	6800	Flansch					
840157N	John Deere	Schlepper / 6000-6930	6810	O-Ring					
840039N	John Deere	Schlepper / 6000-6930	6900	Flansch					
840157N	John Deere	Schlepper / 6000-6930	6910	O-Ring					
840157N	John Deere	Schlepper / 6000-6930	6910S	O-Ring					
840039N	John Deere	Schlepper / 7000-7920	7600	Flansch					
840039N	John Deere	Schlepper / 7000-7920	7610	Flansch					
840039N	John Deere	Schlepper / 7000-7920	7700	Flansch					
840039N	John Deere	Schlepper / 7000-7920	7710	Flansch					
840163N	John Deere	Schlepper / 7000-7920	7720	O-Ring	3/8 / 1/2	5/8 / 3/4			
840039N	John Deere	Schlepper / 7000-7920	7800	Flansch					
840039N	John Deere	Schlepper / 7000-7920	7810	Flansch					
840163N	John Deere	Schlepper / 7000-7920	7820	O-Ring	3/8 / 1/2	5/8 / 3/4			
840163N	John Deere	Schlepper / 7000-7920	7920	O-Ring	3/8 / 1/2	5/8 / 3/4			
840157N	John Deere	Schlepper / 8000-8640	8100	O-Ring					
840157N	John Deere	Schlepper / 8000-8640	8110	O-Ring					
840163N	John Deere	Schlepper / 8000-8640	8120	O-Ring	3/8 / 1/2	5/8 / 3/4			
840163N	John Deere	Schlepper / 8000-8640	8130	O-Ring	3/8 / 1/2	5/8 / 3/4			
840157N	John Deere	Schlepper / 8000-8640	8200	O-Ring					

Dasis Nr.	Hersteller	Modell	Typ	Spezifikation	Innengewindemaß Druckseite	Innengewindemaß Saugseite	Außengewindemaß Druckseite	Außengewindemaß Saugseite	Kapillarrohrlänge [mm]
840157N	John Deere	Schlepper / 8000-8640	8210	O-Ring					
840163N	John Deere	Schlepper / 8000-8640	8220	O-Ring	3/8 / 1/2	5/8 / 3/4			
840163N	John Deere	Schlepper / 8000-8640	8230	O-Ring	3/8 / 1/2	5/8 / 3/4			
840157N	John Deere	Schlepper / 8000-8640	8300	O-Ring					
840157N	John Deere	Schlepper / 8000-8640	8310	O-Ring					
840163N	John Deere	Schlepper / 8000-8640	8320	O-Ring	3/8 / 1/2	5/8 / 3/4			
840163N	John Deere	Schlepper / 8000-8640	8330	O-Ring	3/8 / 1/2	5/8 / 3/4			
840157N	John Deere	Schlepper / 8000-8640	8400	O-Ring					
840157N	John Deere	Schlepper / 8000-8640	8410	O-Ring					
840084N	John Deere	Schlepper / 8000-8640	8430				16	18	305
840084N	John Deere	Schlepper / 8000-8640	8440				16	18	305
840163N	John Deere	Schlepper / 8000-8640	8520	O-Ring	3/8 / 1/2	5/8 / 3/4			
840163N	John Deere	Schlepper / 8000-8640	8530	O-Ring	3/8 / 1/2	5/8 / 3/4			
840670N	John Deere	Schlepper / 8000-8640	8570						
840084N	John Deere	Schlepper / 8000-8640	8640				16	18	305
840670N	John Deere	Schlepper / 9000-9620	9100						
840157N	John Deere	Schlepper / 9000-9620	9120	O-Ring					
840670N	John Deere	Schlepper / 9000-9620	9200						
840157N	John Deere	Schlepper / 9000-9620	9220	O-Ring					
840670N	John Deere	Schlepper / 9000-9620	9300						
840157N	John Deere	Schlepper / 9000-9620	9320	O-Ring					

Dasis Nr.	Hersteller	Modell	Typ	Spezifikation	Innengewindemaß Druckseite	Innengewindemaß Saugseite	Außengewindemaß Druckseite	Außengewindemaß Saugseite	Kapillarrohrlänge [mm]
840670N	John Deere	Schlepper / 9000-9620	9400						
840157N	John Deere	Schlepper / 9000-9620	9420	O-Ring					
840157N	John Deere	Schlepper / 9000-9620	9520	O-Ring					
840157N	John Deere	Schlepper / 9000-9620	9620	O-Ring					
840086N	John Deere	Schlepper / CTS	CTS II	Innengewinde					
840039N	John Deere	Schlepper Wein Obst / 5000N-9620	5215F	Flansch					
840039N	John Deere	Schlepper Wein Obst / 5000N-9620	5215V	Flansch					
840039N	John Deere	Schlepper Wein Obst / 5000N-9620	5300	Flansch					
840039N	John Deere	Schlepper Wein Obst / 5000N-9620	5310	Flansch					
840039N	John Deere	Schlepper Wein Obst / 5000N-9620	5315F	Flansch					
840039N	John Deere	Schlepper Wein Obst / 5000N-9620	5315V	Flansch					
840039N	John Deere	Schlepper Wein Obst / 5000N-9620	5400	Flansch					
840039N	John Deere	Schlepper Wein Obst / 5000N-9620	5410	Flansch					
840039N	John Deere	Schlepper Wein Obst / 5000N-9620	5500	Flansch					
840157N	John Deere	Schlepper Wein Obst / 5000N-9620	9120	O-Ring					
840157N	John Deere	Schlepper Wein Obst / 5000N-9620	9220	O-Ring					
840157N	John Deere	Schlepper Wein Obst / 5000N-9620	9320	O-Ring					
840157N	John Deere	Schlepper Wein Obst / 5000N-9620	9420	O-Ring					
840157N	John Deere	Schlepper Wein Obst / 5000N-9620	9520	O-Ring					
840157N	John Deere	Schlepper Wein Obst / 5000N-9620	9620	O-Ring					
840163N	John Deere	Schürfzüge / 800	872	O-Ring	3/8 / 1/2	5/8 / 3/4			
840163N	John Deere	Selbstfahrende Feldspritze	4700	O-Ring	3/8 / 1/2	5/8 / 3/4			

Dasis Nr.	Hersteller	Modell	Typ	Spezifikation	Innengewindemaß Druckseite	Innengewindemaß Saugseite	Außengewindemaß Druckseite	Außengewindemaß Saugseite	Kapillarrohrlänge [mm]
840163N	John Deere	Selbstfahrende Feldspritze	4710	O-Ring	3/8 / 1/2	5/8 / 3/4			
840163N	John Deere	Selbstfahrende Feldspritze	4920	O-Ring	3/8 / 1/2	5/8 / 3/4			
840163N	John Deere	Selbstfahrende Feldspritze	4930	O-Ring	3/8 / 1/2	5/8 / 3/4			
840048N	John Deere	Selbstfahrende Feldspritze	5440	Flansch					
840084N	John Deere	Selbstfahrende Feldspritze	6000				16	18	305
840084N	John Deere	Selbstfahrende Feldspritze	6100				16	18	305
840084N	John Deere	Selbstfahrende Feldspritze	6500				16	18	305
840084N	John Deere	Selbstfahrende Feldspritze	6600				16	18	305
840048N	John Deere	Selbstfahrende Feldspritze	7200	Flansch					
840048N	John Deere	Selbstfahrende Feldspritze	7300	Flansch					
840048N	John Deere	Selbstfahrende Feldspritze	7400	Flansch					
840048N	John Deere	Selbstfahrende Feldspritze	7500	Flansch					
840048N	John Deere	Selbstfahrende Feldspritze	7700	Flansch					
840048N	John Deere	Selbstfahrende Feldspritze	7800	Flansch					
840050N	John Deere	Selbstfahrende Schwadmäher / 2200-6670	2250	Konus			13,0	16,0	480
840050N	John Deere	Selbstfahrende Schwadmäher / 2200-6670	2270	Konus			13,0	16,0	480
840050N	John Deere	Selbstfahrende Schwadmäher / 2200-6670	2280	Konus			13,0	16,0	480
840084N	John Deere	Selbstfahrende Schwadmäher / 2200-6670	2320				16	18	305
840084N	John Deere	Selbstfahrende Schwadmäher / 2200-6670	2420				16	18	305



Dasis Nr.	Hersteller	Modell	Typ	Spezifikation	Innengewindemaß Druckseite	Innengewindemaß Saugseite	Außengewindemaß Druckseite	Außengewindemaß Saugseite	Kapillarrohrlänge [mm]
840084N	John Deere	Selbstfahrende Schwadmäher / 2200-6670	3430				16	18	305
840084N	John Deere	Selbstfahrende Schwadmäher / 2200-6670	3830				16	18	305
840084N	John Deere	Selbstfahrende Schwadmäher / 2200-6670	6670				16	18	305
840039N	John Deere	Teleskoplader / 3200-3400	3200	Flansch					
840039N	John Deere	Teleskoplader / 3200-3400	3215	Flansch					
840039N	John Deere	Teleskoplader / 3200-3400	3220	Flansch					
840086N	John Deere	Teleskoplader / CTS	CTS	Innengewinde					
840130N	Komatsu	Bagger 360 Grad / PC	60-1000	O-Ring					
840019N	Komatsu	Muldenkipper / HD	325-6						
840019N	Komatsu	Muldenkipper / HD	405-6						
840019N	Komatsu	Muldenkipper / HD	465-5						
840019N	Komatsu	Muldenkipper / HD	605-7R						
840019N	Komatsu	Muldenkipper / HD	985-5						
840130N	Komatsu	Schaufellader / WA	350-650	O-Ring					
840048N	Krone	Mähdrescher BIG M	BIGM	Flansch					
840159N	Landini	Mähdrescher / Rex	75V						
840159N	Landini	Mähdrescher / Rex	85V						
840159N	Landini	Mähdrescher / Rex	90GT						
840159N	Landini	Mähdrescher / Rex	95F						
840091N	Landini	Schlepper / Blizzard	65	O-Ring			16	18	300
840091N	Landini	Schlepper / Blizzard	75	O-Ring			16	18	300
840091N	Landini	Schlepper / Blizzard	85	O-Ring			16	18	300
840091N	Landini	Schlepper / Blizzard	95	O-Ring			16	18	300
840520N	Landini	Schlepper / Legend	105	O-Ring	3/8 / 1/2	5/8 / 3/4			
840520N	Landini	Schlepper / Legend	115	O-Ring	3/8 / 1/2	5/8 / 3/4			
840520N	Landini	Schlepper / Legend	130	O-Ring	3/8 / 1/2	5/8 / 3/4			

Dasis Nr.	Hersteller	Modell	Typ	Spezifikation	Innengewindemaß Druckseite	Innengewindemaß Saugseite	Außengewindemaß Druckseite	Außengewindemaß Saugseite	Kapillarrohrlänge [mm]
840520N	Landini	Schlepper / Legend	145	O-Ring	3/8 / 1/2	5/8 / 3/4			
840520N	Landini	Schlepper / Legend	165	O-Ring	3/8 / 1/2	5/8 / 3/4			
840490N	Massey Ferguson	Mähdrescher / 10-900	530	O-Ring			16,0	18,0	355
840490N	Massey Ferguson	Mähdrescher / 10-900	535	O-Ring			16,0	18,0	355
840490N	Massey Ferguson	Mähdrescher / 10-900	560	O-Ring			16,0	18,0	355
840490N	Massey Ferguson	Mähdrescher / 10-900	565	O-Ring			16,0	18,0	355
840490N	Massey Ferguson	Mähdrescher / 10-900	660	O-Ring			16,0	18,0	355
840490N	Massey Ferguson	Mähdrescher / 10-900	665	O-Ring			16,0	18,0	355
840130N	Massey Ferguson	Mähdrescher / 10-900	740	O-Ring					
840340N	Massey Ferguson	Mähdrescher / 10-900	740	Konus			15,0	18,0	305
840130N	Massey Ferguson	Mähdrescher / 10-900	750	O-Ring					
840340N	Massey Ferguson	Mähdrescher / 10-900	750	Konus			15,0	18,0	305
840130N	Massey Ferguson	Mähdrescher / 10-900	760	O-Ring					
840340N	Massey Ferguson	Mähdrescher / 10-900	760	Konus			15,0	18,0	305
840490N	Massey Ferguson	Mähdrescher / 10-900	800	O-Ring			16,0	18,0	355
840490N	Massey Ferguson	Mähdrescher / 10-900	805	O-Ring			16,0	18,0	355
840490N	Massey Ferguson	Mähdrescher / 10-900	810	O-Ring			16,0	18,0	355
840490N	Massey Ferguson	Mähdrescher / 10-900	815	O-Ring			16,0	18,0	355
840490N	Massey Ferguson	Mähdrescher / 10-900	820	O-Ring			16,0	18,0	355
840490N	Massey Ferguson	Mähdrescher / 10-900	830	O-Ring			16,0	18,0	355
840490N	Massey Ferguson	Mähdrescher / 10-900	835	O-Ring			16,0	18,0	355
840490N	Massey Ferguson	Mähdrescher / 10-900	840	O-Ring			16,0	18,0	355

Dasis Nr.	Hersteller	Modell	Typ	Spezifikation	Innengewindemaß Druckseite	Innengewindemaß Saugseite	Außengewindemaß Druckseite	Außengewindemaß Saugseite	Kapillarrohrlänge [mm]
840490N	Massey Ferguson	Mähdrescher / 10-900	845	O-Ring			16,0	18,0	355
840490N	Massey Ferguson	Mähdrescher / 10-900	850	O-Ring			16,0	18,0	355
840340N	Massey Ferguson	Mähdrescher / 10-900	860	Konus			15,0	18,0	305
840340N	Massey Ferguson	Mähdrescher / 10-900	865	Konus			15,0	18,0	305
840037N	Massey Ferguson	Mähdrescher / 3400-9790	7244	O-Ring	3/8 / 5/8	5/8 / 5/8			
840037N	Massey Ferguson	Mähdrescher / 3400-9790	7250	O-Ring	3/8 / 5/8	5/8 / 5/8			
840037N	Massey Ferguson	Mähdrescher / 3400-9790	7252	O-Ring	3/8 / 5/8	5/8 / 5/8			
840037N	Massey Ferguson	Mähdrescher / 3400-9790	7254	O-Ring	3/8 / 5/8	5/8 / 5/8			
840037N	Massey Ferguson	Mähdrescher / 3400-9790	7256	O-Ring	3/8 / 5/8	5/8 / 5/8			
840037N	Massey Ferguson	Mähdrescher / 3400-9790	7272	O-Ring	3/8 / 5/8	5/8 / 5/8			
840037N	Massey Ferguson	Mähdrescher / 3400-9790	7274	O-Ring	3/8 / 5/8	5/8 / 5/8			
840037N	Massey Ferguson	Mähdrescher / 3400-9790	7276	O-Ring	3/8 / 5/8	5/8 / 5/8			
840290N	Massey Ferguson	Mähdrescher / 3400-9790	8450	Innengewinde					
840290N	Massey Ferguson	Mähdrescher / 3400-9790	8460	Innengewinde					
840120N	Massey Ferguson	Mähdrescher / MF 24-40	24	O-Ring					
840120N	Massey Ferguson	Mähdrescher / MF 24-40	27	O-Ring					
840120N	Massey Ferguson	Mähdrescher / MF 24-40	29	O-Ring					
840120N	Massey Ferguson	Mähdrescher / MF 24-40	29XP	O-Ring					
840120N	Massey Ferguson	Mähdrescher / MF 24-40	30	O-Ring					
840120N	Massey Ferguson	Mähdrescher / MF 24-40	31	O-Ring					
840120N	Massey Ferguson	Mähdrescher / MF 24-40	31XP	O-Ring					

Dasis Nr.	Hersteller	Modell	Typ	Spezifikation	Innengewindemaß Druckseite	Innengewindemaß Saugseite	Außengewindemaß Druckseite	Außengewindemaß Saugseite	Kapillarrohrlänge [mm]
840120N	Massey Ferguson	Mähdrescher / MF 24-40	32	O-Ring					
840120N	Massey Ferguson	Mähdrescher / MF 24-40	34	O-Ring					
840120N	Massey Ferguson	Mähdrescher / MF 24-40	36	O-Ring					
840120N	Massey Ferguson	Mähdrescher / MF 24-40	38	O-Ring					
840120N	Massey Ferguson	Mähdrescher / MF 24-40	40	O-Ring					
840019N	Massey Ferguson	MF 8600	8650						
840019N	Massey Ferguson	MF 8600	8660						
840019N	Massey Ferguson	MF 8600	8670						
840019N	Massey Ferguson	MF 8600	8680						
840019N	Massey Ferguson	MF 8600	8690						
840370N	Massey Ferguson	Schlepper / 300	340				16	18	
840370N	Massey Ferguson	Schlepper / 300	342				16	18	
840370N	Massey Ferguson	Schlepper / 300	350				16	18	
840370N	Massey Ferguson	Schlepper / 300	352				16	18	
840370N	Massey Ferguson	Schlepper / 300	353				16	18	
840370N	Massey Ferguson	Schlepper / 300	354				16	18	
840370N	Massey Ferguson	Schlepper / 300	355				16	18	
840370N	Massey Ferguson	Schlepper / 300	360				16	18	
840370N	Massey Ferguson	Schlepper / 300	362				16	18	
840370N	Massey Ferguson	Schlepper / 300	362N				16	18	
840370N	Massey Ferguson	Schlepper / 300	363				16	18	
840370N	Massey Ferguson	Schlepper / 300	365				16	18	
840370N	Massey Ferguson	Schlepper / 300	372				16	18	
840091N	Massey Ferguson	Schlepper / 300	373	O-Ring			16	18	300
840091N	Massey Ferguson	Schlepper / 300	373S	O-Ring			16	18	300
840091N	Massey Ferguson	Schlepper / 300	374	O-Ring			16	18	300
840091N	Massey Ferguson	Schlepper / 300	374S	O-Ring			16	18	300
840370N	Massey Ferguson	Schlepper / 300	375				16	18	
840370N	Massey Ferguson	Schlepper / 300	377				16	18	

Dasis Nr.	Hersteller	Modell	Typ	Spezifikation	Innengewindemaß Druckseite	Innengewindemaß Saugseite	Außengewindemaß Druckseite	Außengewindemaß Saugseite	Kapillarrohrlänge [mm]
840370N	Massey Ferguson	Schlepper / 300	382				16	18	
840091N	Massey Ferguson	Schlepper / 300	383	O-Ring			16	18	300
840091N	Massey Ferguson	Schlepper / 300	383S	O-Ring			16	18	300
840091N	Massey Ferguson	Schlepper / 300	384	O-Ring			16	18	300
840091N	Massey Ferguson	Schlepper / 300	384F	O-Ring			16	18	300
840370N	Massey Ferguson	Schlepper / 300	384S				16	18	
840370N	Massey Ferguson	Schlepper / 300	387				16	18	
840370N	Massey Ferguson	Schlepper / 300	390				16	18	
840370N	Massey Ferguson	Schlepper / 300	390T				16	18	
840091N	Massey Ferguson	Schlepper / 300	393	O-Ring			16	18	300
840091N	Massey Ferguson	Schlepper / 300	393F	O-Ring			16	18	300
840091N	Massey Ferguson	Schlepper / 300	393S	O-Ring			16	18	300
840091N	Massey Ferguson	Schlepper / 300	394	O-Ring			16	18	300
840091N	Massey Ferguson	Schlepper / 300	394F	O-Ring			16	18	300
840091N	Massey Ferguson	Schlepper / 300	394S	O-Ring			16	18	300
840370N	Massey Ferguson	Schlepper / 300	397				16	18	
840370N	Massey Ferguson	Schlepper / 300	398				16	18	
840370N	Massey Ferguson	Schlepper / 300	399				16	18	
841041N	Massey Ferguson	Schlepper / 500	550	Flansch					305
841041N	Massey Ferguson	Schlepper / 500	560	Flansch					305
841041N	Massey Ferguson	Schlepper / 500	565	Flansch					305
841041N	Massey Ferguson	Schlepper / 500	575	Flansch					305
841041N	Massey Ferguson	Schlepper / 500	590	Flansch					305
841041N	Massey Ferguson	Schlepper / 500	592	Flansch					305
841041N	Massey Ferguson	Schlepper / 500	595	Flansch					305
841041N	Massey Ferguson	Schlepper / 500	595K	Flansch					305
840086N	Massey Ferguson	Schlepper / 2000	2620	Innengewinde					
840091N	Massey Ferguson	Schlepper / 2000	2620	O-Ring			16	18	300
840340N	Massey Ferguson	Schlepper / 2000	2620	Konus			15,0	18,0	305
840086N	Massey Ferguson	Schlepper / 2000	2625	Innengewinde					
840091N	Massey Ferguson	Schlepper / 2000	2625	O-Ring			16	18	300

Dasis Nr.	Hersteller	Modell	Typ	Spezifikation	Innengewindemaß Druckseite	Innengewindemaß Saugseite	Außengewindemaß Druckseite	Außengewindemaß Saugseite	Kapillarrohrlänge [mm]
840340N	Massey Ferguson	Schlepper / 2000	2625	Konus			15,0	18,0	305
840086N	Massey Ferguson	Schlepper / 2000	2640	Innengewinde					
840091N	Massey Ferguson	Schlepper / 2000	2640	O-Ring			16	18	300
840340N	Massey Ferguson	Schlepper / 2000	2640	Konus			15,0	18,0	305
840086N	Massey Ferguson	Schlepper / 2000	2645	Innengewinde					
840091N	Massey Ferguson	Schlepper / 2000	2645	O-Ring			16	18	300
840340N	Massey Ferguson	Schlepper / 2000	2645	Konus			15,0	18,0	305
840086N	Massey Ferguson	Schlepper / 2000	2675	Innengewinde					
840091N	Massey Ferguson	Schlepper / 2000	2675	O-Ring			16	18	300
840340N	Massey Ferguson	Schlepper / 2000	2675	Konus			15,0	18,0	305
840086N	Massey Ferguson	Schlepper / 2000	2680	Innengewinde					
840091N	Massey Ferguson	Schlepper / 2000	2680	O-Ring			16	18	300
840340N	Massey Ferguson	Schlepper / 2000	2680	Konus			15,0	18,0	305
840086N	Massey Ferguson	Schlepper / 2000	2685	Innengewinde					
840091N	Massey Ferguson	Schlepper / 2000	2685	O-Ring			16	18	300
840340N	Massey Ferguson	Schlepper / 2000	2685	Konus			15,0	18,0	305
840091N	Massey Ferguson	Schlepper / 2000	2705	O-Ring			16	18	300
840340N	Massey Ferguson	Schlepper / 2000	2705	Konus			15,0	18,0	305
840340N	Massey Ferguson	Schlepper / 2000	2805	Konus			15,0	18,0	305
840037N	Massey Ferguson	Schlepper / 3000	3050	O-Ring	3/8 / 5/8	5/8 / 5/8			
840120N	Massey Ferguson	Schlepper / 3000	3050	O-Ring					
840037N	Massey Ferguson	Schlepper / 3000	3060	O-Ring	3/8 / 5/8	5/8 / 5/8			
840120N	Massey Ferguson	Schlepper / 3000	3060	O-Ring					
840037N	Massey Ferguson	Schlepper / 3000	3065	O-Ring	3/8 / 5/8	5/8 / 5/8			
840120N	Massey Ferguson	Schlepper / 3000	3065	O-Ring					
840037N	Massey Ferguson	Schlepper / 3000	3070	O-Ring	3/8 / 5/8	5/8 / 5/8			
840120N	Massey Ferguson	Schlepper / 3000	3070	O-Ring					
840037N	Massey Ferguson	Schlepper / 3000	3075	O-Ring	3/8 / 5/8	5/8 / 5/8			
840120N	Massey Ferguson	Schlepper / 3000	3075	O-Ring					
840120N	Massey Ferguson	Schlepper / 3000	3080	O-Ring					
840037N	Massey Ferguson	Schlepper / 3000	3080	O-Ring	3/8 / 5/8	5/8 / 5/8			

Dasis Nr.	Hersteller	Modell	Typ	Spezifikation	Innengewindemaß Druckseite	Innengewindemaß Saugseite	Außengewindemaß Druckseite	Außengewindemaß Saugseite	Kapillarrohrlänge [mm]
840120N	Massey Ferguson	Schlepper / 3000	3085	O-Ring					
840037N	Massey Ferguson	Schlepper / 3000	3085	O-Ring	3/8 / 5/8	5/8 / 5/8			
840120N	Massey Ferguson	Schlepper / 3000	3090	O-Ring					
840037N	Massey Ferguson	Schlepper / 3000	3090	O-Ring	3/8 / 5/8	5/8 / 5/8			
840037N	Massey Ferguson	Schlepper / 3000	3095	O-Ring	3/8 / 5/8	5/8 / 5/8			
840120N	Massey Ferguson	Schlepper / 3000	3095	O-Ring					
840120N	Massey Ferguson	Schlepper / 3000	3115	O-Ring					
840037N	Massey Ferguson	Schlepper / 3000	3115	O-Ring	3/8 / 5/8	5/8 / 5/8			
840120N	Massey Ferguson	Schlepper / 3000	3120	O-Ring					
840037N	Massey Ferguson	Schlepper / 3000	3120	O-Ring	3/8 / 5/8	5/8 / 5/8			
840120N	Massey Ferguson	Schlepper / 3000	3120T	O-Ring					
840037N	Massey Ferguson	Schlepper / 3000	3120T	O-Ring	3/8 / 5/8	5/8 / 5/8			
840037N	Massey Ferguson	Schlepper / 3000	3125	O-Ring	3/8 / 5/8	5/8 / 5/8			
840120N	Massey Ferguson	Schlepper / 3000	3125	O-Ring					
840120N	Massey Ferguson	Schlepper / 3000	3140	O-Ring					
840037N	Massey Ferguson	Schlepper / 3000	3140	O-Ring	3/8 / 5/8	5/8 / 5/8			
840084N	Massey Ferguson	Schlepper / 3000	3505				16	18	305
840084N	Massey Ferguson	Schlepper / 3000	3525				16	18	305
840084N	Massey Ferguson	Schlepper / 3000	3545				16	18	305
840120N	Massey Ferguson	Schlepper / 3000	3610	O-Ring					
840037N	Massey Ferguson	Schlepper / 3000	3610	O-Ring	3/8 / 5/8	5/8 / 5/8			
840037N	Massey Ferguson	Schlepper / 3000	3630	O-Ring	3/8 / 5/8	5/8 / 5/8			
840120N	Massey Ferguson	Schlepper / 3000	3630	O-Ring					
840037N	Massey Ferguson	Schlepper / 3000	3635	O-Ring	3/8 / 5/8	5/8 / 5/8			
840120N	Massey Ferguson	Schlepper / 3000	3635	O-Ring					
840037N	Massey Ferguson	Schlepper / 3000	3645	O-Ring	3/8 / 5/8	5/8 / 5/8			
840120N	Massey Ferguson	Schlepper / 3000	3645	O-Ring					
840037N	Massey Ferguson	Schlepper / 3000	3650	O-Ring	3/8 / 5/8	5/8 / 5/8			
840120N	Massey Ferguson	Schlepper / 3000	3650	O-Ring					
840037N	Massey Ferguson	Schlepper / 3000	3655	O-Ring	3/8 / 5/8	5/8 / 5/8			
840120N	Massey Ferguson	Schlepper / 3000	3655	O-Ring					

Dasis Nr.	Hersteller	Modell	Typ	Spezifikation	Innengewindemaß Druckseite	Innengewindemaß Saugseite	Außengewindemaß Druckseite	Außengewindemaß Saugseite	Kapillarrohrlänge [mm]
840037N	Massey Ferguson	Schlepper / 3000	3660	O-Ring	3/8 / 5/8	5/8 / 5/8			
840120N	Massey Ferguson	Schlepper / 3000	3660	O-Ring					
840037N	Massey Ferguson	Schlepper / 3000	3670	O-Ring	3/8 / 5/8	5/8 / 5/8			
840120N	Massey Ferguson	Schlepper / 3000	3670	O-Ring					
840037N	Massey Ferguson	Schlepper / 3000	3680	O-Ring	3/8 / 5/8	5/8 / 5/8			
840120N	Massey Ferguson	Schlepper / 3000	3680	O-Ring					
840120N	Massey Ferguson	Schlepper / 3000	3690	O-Ring					
840037N	Massey Ferguson	Schlepper / 3000	3690	O-Ring	3/8 / 5/8	5/8 / 5/8			
840155N	Massey Ferguson	Schlepper / 4000	4215						
840155N	Massey Ferguson	Schlepper / 4000	4220						
840086N	Massey Ferguson	Schlepper / 4000	4225	Innengewinde					
840155N	Massey Ferguson	Schlepper / 4000	4225						
840086N	Massey Ferguson	Schlepper / 4000	4235	Innengewinde					
840155N	Massey Ferguson	Schlepper / 4000	4235						
840155N	Massey Ferguson	Schlepper / 4000	4240						
840086N	Massey Ferguson	Schlepper / 4000	4240	Innengewinde					
840155N	Massey Ferguson	Schlepper / 4000	4243						
840155N	Massey Ferguson	Schlepper / 4000	4245						
840086N	Massey Ferguson	Schlepper / 4000	4245	Innengewinde					
840086N	Massey Ferguson	Schlepper / 4000	4255	Innengewinde					
840086N	Massey Ferguson	Schlepper / 4000	4260	Innengewinde					
840086N	Massey Ferguson	Schlepper / 4000	4265	Innengewinde					
840086N	Massey Ferguson	Schlepper / 4000	4270	Innengewinde					
840019N	Massey Ferguson	Schlepper / 4000	4315						
840156N	Massey Ferguson	Schlepper / 4000	4315						
840156N	Massey Ferguson	Schlepper / 4000	4320						
840156N	Massey Ferguson	Schlepper / 4000	4325						
840019N	Massey Ferguson	Schlepper / 4000	4325						
840019N	Massey Ferguson	Schlepper / 4000	4335						
840156N	Massey Ferguson	Schlepper / 4000	4335						
840156N	Massey Ferguson	Schlepper / 4000	4345						



Dasis Nr.	Hersteller	Modell	Typ	Spezifikation	Innengewindemaß Druckseite	Innengewindemaß Saugseite	Außengewindemaß Druckseite	Außengewindemaß Saugseite	Kapillarrohrlänge [mm]
840019N	Massey Ferguson	Schlepper / 4000	4345						
840019N	Massey Ferguson	Schlepper / 4000	4355						
840156N	Massey Ferguson	Schlepper / 4000	4355						
840019N	Massey Ferguson	Schlepper / 4000	4360						
840156N	Massey Ferguson	Schlepper / 4000	4360						
840019N	Massey Ferguson	Schlepper / 4000	4370						
840156N	Massey Ferguson	Schlepper / 4000	4370						
840037N	Massey Ferguson	Schlepper / 5000	5425	O-Ring	3/8 / 5/8	5/8 / 5/8			
840155N	Massey Ferguson	Schlepper / 5000	5425						
840037N	Massey Ferguson	Schlepper / 5000	5435	O-Ring	3/8 / 5/8	5/8 / 5/8			
840155N	Massey Ferguson	Schlepper / 5000	5435						
840037N	Massey Ferguson	Schlepper / 5000	5445	O-Ring	3/8 / 5/8	5/8 / 5/8			
840155N	Massey Ferguson	Schlepper / 5000	5445						
840155N	Massey Ferguson	Schlepper / 5000	5455						
840037N	Massey Ferguson	Schlepper / 5000	5455	O-Ring	3/8 / 5/8	5/8 / 5/8			
840155N	Massey Ferguson	Schlepper / 5000	5460						
840037N	Massey Ferguson	Schlepper / 5000	5460	O-Ring	3/8 / 5/8	5/8 / 5/8			
840155N	Massey Ferguson	Schlepper / 5000	5470						
840037N	Massey Ferguson	Schlepper / 5000	5470	O-Ring	3/8 / 5/8	5/8 / 5/8			
840155N	Massey Ferguson	Schlepper / 5000	5480						
840037N	Massey Ferguson	Schlepper / 5000	5480	O-Ring	3/8 / 5/8	5/8 / 5/8			
840037N	Massey Ferguson	Schlepper / 6000	6110	O-Ring	3/8 / 5/8	5/8 / 5/8			
840155N	Massey Ferguson	Schlepper / 6000	6110						
840155N	Massey Ferguson	Schlepper / 6000	6120						
840086N	Massey Ferguson	Schlepper / 6000	6120	Innengewinde					
840037N	Massey Ferguson	Schlepper / 6000	6120	O-Ring	3/8 / 5/8	5/8 / 5/8			
840155N	Massey Ferguson	Schlepper / 6000	6130						
840037N	Massey Ferguson	Schlepper / 6000	6130	O-Ring	3/8 / 5/8	5/8 / 5/8			
840086N	Massey Ferguson	Schlepper / 6000	6130	Innengewinde					
840155N	Massey Ferguson	Schlepper / 6000	6140						
840086N	Massey Ferguson	Schlepper / 6000	6140	Innengewinde					

Dasis Nr.	Hersteller	Modell	Typ	Spezifikation	Innengewindemaß Druckseite	Innengewindemaß Saugseite	Außengewindemaß Druckseite	Außengewindemaß Saugseite	Kapillarrohrlänge [mm]
840037N	Massey Ferguson	Schlepper / 6000	6140	O-Ring	3/8 / 5/8	5/8 / 5/8			
840086N	Massey Ferguson	Schlepper / 6000	6150	Innengewinde					
840155N	Massey Ferguson	Schlepper / 6000	6150						
840037N	Massey Ferguson	Schlepper / 6000	6150	O-Ring	3/8 / 5/8	5/8 / 5/8			
840155N	Massey Ferguson	Schlepper / 6000	6160						
840037N	Massey Ferguson	Schlepper / 6000	6160	O-Ring	3/8 / 5/8	5/8 / 5/8			
840086N	Massey Ferguson	Schlepper / 6000	6160	Innengewinde					
840155N	Massey Ferguson	Schlepper / 6000	6170						
840037N	Massey Ferguson	Schlepper / 6000	6170	O-Ring	3/8 / 5/8	5/8 / 5/8			
840086N	Massey Ferguson	Schlepper / 6000	6170	Innengewinde					
840155N	Massey Ferguson	Schlepper / 6000	6180						
840037N	Massey Ferguson	Schlepper / 6000	6180	O-Ring	3/8 / 5/8	5/8 / 5/8			
840086N	Massey Ferguson	Schlepper / 6000	6180	Innengewinde					
840086N	Massey Ferguson	Schlepper / 6000	6190	Innengewinde					
840037N	Massey Ferguson	Schlepper / 6000	6190	O-Ring	3/8 / 5/8	5/8 / 5/8			
840155N	Massey Ferguson	Schlepper / 6000	6190						
840086N	Massey Ferguson	Schlepper / 6000	6235	Innengewinde					
840037N	Massey Ferguson	Schlepper / 6000	6235	O-Ring	3/8 / 5/8	5/8 / 5/8			
840155N	Massey Ferguson	Schlepper / 6000	6235						
840086N	Massey Ferguson	Schlepper / 6000	6245	Innengewinde					
840037N	Massey Ferguson	Schlepper / 6000	6245	O-Ring	3/8 / 5/8	5/8 / 5/8			
840155N	Massey Ferguson	Schlepper / 6000	6245						
840086N	Massey Ferguson	Schlepper / 6000	6255	Innengewinde					
840037N	Massey Ferguson	Schlepper / 6000	6255	O-Ring	3/8 / 5/8	5/8 / 5/8			
840155N	Massey Ferguson	Schlepper / 6000	6255						
840037N	Massey Ferguson	Schlepper / 6000	6260	O-Ring	3/8 / 5/8	5/8 / 5/8			
840155N	Massey Ferguson	Schlepper / 6000	6260						
840086N	Massey Ferguson	Schlepper / 6000	6260	Innengewinde					
840037N	Massey Ferguson	Schlepper / 6000	6265	O-Ring	3/8 / 5/8	5/8 / 5/8			
840086N	Massey Ferguson	Schlepper / 6000	6265	Innengewinde					
840155N	Massey Ferguson	Schlepper / 6000	6265						

Dasis Nr.	Hersteller	Modell	Typ	Spezifikation	Innengewindemaß Druckseite	Innengewindemaß Saugseite	Außengewindemaß Druckseite	Außengewindemaß Saugseite	Kapillarrohrlänge [mm]
840086N	Massey Ferguson	Schlepper / 6000	6270	Innengewinde					
840155N	Massey Ferguson	Schlepper / 6000	6270						
840037N	Massey Ferguson	Schlepper / 6000	6270	O-Ring	3/8 / 5/8	5/8 / 5/8			
840086N	Massey Ferguson	Schlepper / 6000	6280	Innengewinde					
840037N	Massey Ferguson	Schlepper / 6000	6280	O-Ring	3/8 / 5/8	5/8 / 5/8			
840155N	Massey Ferguson	Schlepper / 6000	6280						
840086N	Massey Ferguson	Schlepper / 6000	6290	Innengewinde					
840037N	Massey Ferguson	Schlepper / 6000	6290	O-Ring	3/8 / 5/8	5/8 / 5/8			
840155N	Massey Ferguson	Schlepper / 6000	6290						
840037N	Massey Ferguson	Schlepper / 6000	6445	O-Ring	3/8 / 5/8	5/8 / 5/8			
840037N	Massey Ferguson	Schlepper / 6000	6455	O-Ring	3/8 / 5/8	5/8 / 5/8			
840037N	Massey Ferguson	Schlepper / 6000	6460	O-Ring	3/8 / 5/8	5/8 / 5/8			
840037N	Massey Ferguson	Schlepper / 6000	6465	O-Ring	3/8 / 5/8	5/8 / 5/8			
840037N	Massey Ferguson	Schlepper / 6000	6470	O-Ring	3/8 / 5/8	5/8 / 5/8			
840037N	Massey Ferguson	Schlepper / 6000	6475	O-Ring	3/8 / 5/8	5/8 / 5/8			
840037N	Massey Ferguson	Schlepper / 6000	6480	O-Ring	3/8 / 5/8	5/8 / 5/8			
840037N	Massey Ferguson	Schlepper / 6000	6485	O-Ring	3/8 / 5/8	5/8 / 5/8			
840037N	Massey Ferguson	Schlepper / 6000	6490	O-Ring	3/8 / 5/8	5/8 / 5/8			
840037N	Massey Ferguson	Schlepper / 6000	6495	O-Ring	3/8 / 5/8	5/8 / 5/8			
840037N	Massey Ferguson	Schlepper / 6000	6497	O-Ring	3/8 / 5/8	5/8 / 5/8			
840037N	Massey Ferguson	Schlepper / 6000	6499	O-Ring	3/8 / 5/8	5/8 / 5/8			
840037N	Massey Ferguson	Schlepper / 7000	7465	O-Ring	3/8 / 5/8	5/8 / 5/8			
840037N	Massey Ferguson	Schlepper / 7000	7475	O-Ring	3/8 / 5/8	5/8 / 5/8			
840037N	Massey Ferguson	Schlepper / 7000	7480	O-Ring	3/8 / 5/8	5/8 / 5/8			
840037N	Massey Ferguson	Schlepper / 7000	7485	O-Ring	3/8 / 5/8	5/8 / 5/8			
840037N	Massey Ferguson	Schlepper / 7000	7490	O-Ring	3/8 / 5/8	5/8 / 5/8			
840037N	Massey Ferguson	Schlepper / 7000	7495	O-Ring	3/8 / 5/8	5/8 / 5/8			
840037N	Massey Ferguson	Schlepper / 7000	7495Räder3	O-Ring	3/8 / 5/8	5/8 / 5/8			
840037N	Massey Ferguson	Schlepper / 8000	8110	O-Ring	3/8 / 5/8	5/8 / 5/8			
840086N	Massey Ferguson	Schlepper / 8000	8110	Innengewinde					
840155N	Massey Ferguson	Schlepper / 8000	8110						

Dasis Nr.	Hersteller	Modell	Typ	Spezifikation	Innengewindemaß Druckseite	Innengewindemaß Saugseite	Außengewindemaß Druckseite	Außengewindemaß Saugseite	Kapillarrohrlänge [mm]
840037N	Massey Ferguson	Schlepper / 8000	8120	O-Ring	3/8 / 5/8	5/8 / 5/8			
840086N	Massey Ferguson	Schlepper / 8000	8120	Innengewinde					
840155N	Massey Ferguson	Schlepper / 8000	8120						
840086N	Massey Ferguson	Schlepper / 8000	8130	Innengewinde					
840155N	Massey Ferguson	Schlepper / 8000	8130						
840037N	Massey Ferguson	Schlepper / 8000	8130	O-Ring	3/8 / 5/8	5/8 / 5/8			
840086N	Massey Ferguson	Schlepper / 8000	8140	Innengewinde					
840155N	Massey Ferguson	Schlepper / 8000	8140						
840037N	Massey Ferguson	Schlepper / 8000	8140	O-Ring	3/8 / 5/8	5/8 / 5/8			
840155N	Massey Ferguson	Schlepper / 8000	8150						
840086N	Massey Ferguson	Schlepper / 8000	8150	Innengewinde					
840037N	Massey Ferguson	Schlepper / 8000	8150	O-Ring	3/8 / 5/8	5/8 / 5/8			
840037N	Massey Ferguson	Schlepper / 8000	8160	O-Ring	3/8 / 5/8	5/8 / 5/8			
840155N	Massey Ferguson	Schlepper / 8000	8160						
840086N	Massey Ferguson	Schlepper / 8000	8160	Innengewinde					
840037N	Massey Ferguson	Schlepper / 8000	8170	O-Ring	3/8 / 5/8	5/8 / 5/8			
840155N	Massey Ferguson	Schlepper / 8000	8170						
840086N	Massey Ferguson	Schlepper / 8000	8170	Innengewinde					
840155N	Massey Ferguson	Schlepper / 8000	8180						
840037N	Massey Ferguson	Schlepper / 8000	8180	O-Ring	3/8 / 5/8	5/8 / 5/8			
840086N	Massey Ferguson	Schlepper / 8000	8180	Innengewinde					
840155N	Massey Ferguson	Schlepper / 8000	8210						
840086N	Massey Ferguson	Schlepper / 8000	8210	Innengewinde					
840037N	Massey Ferguson	Schlepper / 8000	8210	O-Ring	3/8 / 5/8	5/8 / 5/8			
840155N	Massey Ferguson	Schlepper / 8000	8220						
840086N	Massey Ferguson	Schlepper / 8000	8220	Innengewinde					
840037N	Massey Ferguson	Schlepper / 8000	8220	O-Ring	3/8 / 5/8	5/8 / 5/8			
840037N	Massey Ferguson	Schlepper / 8000	8240	O-Ring	3/8 / 5/8	5/8 / 5/8			
840155N	Massey Ferguson	Schlepper / 8000	8240						
840086N	Massey Ferguson	Schlepper / 8000	8240	Innengewinde					
840155N	Massey Ferguson	Schlepper / 8000	8250						

Dasis Nr.	Hersteller	Modell	Typ	Spezifikation	Innengewindemaß Druckseite	Innengewindemaß Saugseite	Außengewindemaß Druckseite	Außengewindemaß Saugseite	Kapillarrohrlänge [mm]
840037N	Massey Ferguson	Schlepper / 8000	8250	O-Ring	3/8 / 5/8	5/8 / 5/8			
840086N	Massey Ferguson	Schlepper / 8000	8250	Innengewinde					
840086N	Massey Ferguson	Schlepper / 8000	8260	Innengewinde					
840155N	Massey Ferguson	Schlepper / 8000	8260						
840037N	Massey Ferguson	Schlepper / 8000	8260	O-Ring	3/8 / 5/8	5/8 / 5/8			
840086N	Massey Ferguson	Schlepper / 8000	8270	Innengewinde					
840037N	Massey Ferguson	Schlepper / 8000	8270	O-Ring	3/8 / 5/8	5/8 / 5/8			
840155N	Massey Ferguson	Schlepper / 8000	8270						
840086N	Massey Ferguson	Schlepper / 8000	8280	Innengewinde					
840037N	Massey Ferguson	Schlepper / 8000	8280	O-Ring	3/8 / 5/8	5/8 / 5/8			
840155N	Massey Ferguson	Schlepper / 8000	8280						
840037N	Massey Ferguson	Schlepper Obst Wein / 8400	8450	O-Ring	3/8 / 5/8	5/8 / 5/8			
840037N	Massey Ferguson	Schlepper Obst Wein / 8400	8460	O-Ring	3/8 / 5/8	5/8 / 5/8			
840037N	Massey Ferguson	Schlepper Obst Wein / 8400	8470	O-Ring	3/8 / 5/8	5/8 / 5/8			
840037N	Massey Ferguson	Schlepper Obst Wein / 8400	8480	O-Ring	3/8 / 5/8	5/8 / 5/8			
840086N	MC Cormick	Schlepper / CX	70	Innengewinde					
840086N	MC Cormick	Schlepper / CX	80	Innengewinde					
840086N	MC Cormick	Schlepper / CX	90	Innengewinde					
840086N	MC Cormick	Schlepper / CX	100	Innengewinde					
840086N	MC Cormick	Schlepper / F	85	Innengewinde					
840086N	MC Cormick	Schlepper / F	90	Innengewinde					
840086N	MC Cormick	Schlepper / MC	80	Innengewinde					
840086N	MC Cormick	Schlepper / MC	90	Innengewinde					
840086N	MC Cormick	Schlepper / MC	100	Innengewinde					
840086N	MC Cormick	Schlepper / MC	115	Innengewinde					
840086N	MC Cormick	Schlepper / MC	120	Innengewinde					
840086N	MC Cormick	Schlepper / MC	135	Innengewinde					
840086N	MC Cormick	Schlepper / MTX	110	Innengewinde					
840086N	MC Cormick	Schlepper / MTX	120	Innengewinde					
840086N	MC Cormick	Schlepper / MTX	125	Innengewinde					

Dasis Nr.	Hersteller	Modell	Typ	Spezifikation	Innengewindemaß Druckseite	Innengewindemaß Saugseite	Außengewindemaß Druckseite	Außengewindemaß Saugseite	Kapillarrohrlänge [mm]
840086N	MC Cormick	Schlepper / MTX	135	Innengewinde					
840086N	MC Cormick	Schlepper / MTX	140	Innengewinde					
840086N	MC Cormick	Schlepper / MTX	150	Innengewinde					
840086N	MC Cormick	Schlepper / MTX	155	Innengewinde					
840086N	MC Cormick	Schlepper / MTX	165	Innengewinde					
840086N	MC Cormick	Schlepper / MTX	175	Innengewinde					
840086N	MC Cormick	Schlepper / MTX	185	Innengewinde					
840086N	MC Cormick	Schlepper / XTX	185	Innengewinde					
840086N	MC Cormick	Schlepper / XTX	200	Innengewinde					
840086N	MC Cormick	Schlepper / XTX	215	Innengewinde					
840086N	MC Cormick	Schlepper / XTX	230	Innengewinde					
840086N	MC Cormick	Schlepper / XTX	260	Innengewinde					
840086N	MC Cormick	Schlepper / XTX	280	Innengewinde					
840086N	MC Cormick	Schlepper / ZTX	230	Innengewinde					
840086N	MC Cormick	Schlepper / ZTX	260	Innengewinde					
840086N	MC Cormick	Schlepper / ZTX	280	Innengewinde					
840130N	NEW HOLLAND	Baggerlader / 550-575E	555	O-Ring					
840490N	NEW HOLLAND	Baggerlader / 550-575E	555	O-Ring			16,0	18,0	355
840490N	NEW HOLLAND	Baggerlader / 550-575E	555A	O-Ring			16,0	18,0	355
840490N	NEW HOLLAND	Baggerlader / 550-575E	555B	O-Ring			16,0	18,0	355
840129N	NEW HOLLAND	Baggerlader / 550-575E	555E						
840130N	NEW HOLLAND	Baggerlader / 550-575E	575	O-Ring					
840129N	NEW HOLLAND	Baggerlader / 550-575E	575E						
840130N	NEW HOLLAND	Baggerlader / 655-755A	655	O-Ring					
840490N	NEW HOLLAND	Baggerlader / 655-755A	655	O-Ring			16,0	18,0	355
840490N	NEW HOLLAND	Baggerlader / 655-755A	655A	O-Ring			16,0	18,0	355

Dasis Nr.	Hersteller	Modell	Typ	Spezifikation	Innengewindemaß Druckseite	Innengewindemaß Saugseite	Außengewindemaß Druckseite	Außengewindemaß Saugseite	Kapillarrohrlänge [mm]
840129N	NEW HOLLAND	Baggerlader / 655-755A	655E						
840129N	NEW HOLLAND	Baggerlader / 655-755A	675						
840130N	NEW HOLLAND	Baggerlader / 655-755A	675	O-Ring					
840129N	NEW HOLLAND	Baggerlader / 655-755A	675E						
840490N	NEW HOLLAND	Baggerlader / 655-755A	755A	O-Ring			16,0	18,0	355
840160N	NEW HOLLAND	Baggerlader / 9000	9030						710
840129N	NEW HOLLAND	Baggerlader / LB	75						
840129N	NEW HOLLAND	Baggerlader / LB	90						
840129N	NEW HOLLAND	Baggerlader / LB	110						
840490N	NEW HOLLAND	Mähdrescher / 8000	8030	O-Ring			16,0	18,0	355
840490N	NEW HOLLAND	Mähdrescher / 8000	8040	O-Ring			16,0	18,0	355
840490N	NEW HOLLAND	Mähdrescher / 8000	8050	O-Ring			16,0	18,0	355
840490N	NEW HOLLAND	Mähdrescher / 8000	8055	O-Ring			16,0	18,0	355
840490N	NEW HOLLAND	Mähdrescher / 8000	8060	O-Ring			16,0	18,0	355
840490N	NEW HOLLAND	Mähdrescher / 8000	8070	O-Ring			16,0	18,0	355
840490N	NEW HOLLAND	Mähdrescher / 8000	8080	O-Ring			16,0	18,0	355
840490N	NEW HOLLAND	Mähdrescher / TC	52	O-Ring			16,0	18,0	355
840490N	NEW HOLLAND	Mähdrescher / TC	54	O-Ring			16,0	18,0	355
840490N	NEW HOLLAND	Mähdrescher / TF	42	O-Ring			16,0	18,0	355
840490N	NEW HOLLAND	Mähdrescher / TF	44	O-Ring			16,0	18,0	355
840490N	NEW HOLLAND	Mähdrescher / TF	46	O-Ring			16,0	18,0	355
840360N	NEW HOLLAND	Mähdrescher / TR	70	Flansch					840
840360N	NEW HOLLAND	Mähdrescher / TR	75	Flansch					840
840490N	NEW HOLLAND	Mähdrescher / TR	76	O-Ring			16,0	18,0	355
840490N	NEW HOLLAND	Mähdrescher / TR	85	O-Ring			16,0	18,0	355
840490N	NEW HOLLAND	Mähdrescher / TR	86	O-Ring			16,0	18,0	355
840490N	NEW HOLLAND	Mähdrescher / TR	98	O-Ring			16,0	18,0	355
840086N	NEW HOLLAND	Schlepper / 670-8970	670	Innengewinde					

Dasis Nr.	Hersteller	Modell	Typ	Spezifikation	Innengewindemaß Druckseite	Innengewindemaß Saugseite	Außengewindemaß Druckseite	Außengewindemaß Saugseite	Kapillarrohrlänge [mm]
840086N	NEW HOLLAND	Schlepper / 670-8970	8670	Innengewinde					
840086N	NEW HOLLAND	Schlepper / 670-8970	8770	Innengewinde					
840086N	NEW HOLLAND	Schlepper / 670-8970	8870	Innengewinde					
840086N	NEW HOLLAND	Schlepper / 670-8970	8970	Innengewinde					
841042N	NEW HOLLAND	Schlepper / 2110-8210	2310	O-Ring_BULB			15,0	19,0	838
841042N	NEW HOLLAND	Schlepper / 2110-8210	2610	O-Ring_BULB			15,0	19,0	838
841042N	NEW HOLLAND	Schlepper / 2110-8210	2810	O-Ring_BULB			15,0	19,0	838
841042N	NEW HOLLAND	Schlepper / 2110-8210	2910	O-Ring_BULB			15,0	19,0	838
841042N	NEW HOLLAND	Schlepper / 2110-8210	3310	O-Ring_BULB			15,0	19,0	838
841042N	NEW HOLLAND	Schlepper / 2110-8210	3610	O-Ring_BULB			15,0	19,0	838
841042N	NEW HOLLAND	Schlepper / 2110-8210	3910	O-Ring_BULB			15,0	19,0	838
841042N	NEW HOLLAND	Schlepper / 2110-8210	4110	O-Ring_BULB			15,0	19,0	838
841042N	NEW HOLLAND	Schlepper / 2110-8210	4610	O-Ring_BULB			15,0	19,0	838
841042N	NEW HOLLAND	Schlepper / 2110-8210	5110	O-Ring_BULB			15,0	19,0	838
841042N	NEW HOLLAND	Schlepper / 2110-8210	5610	O-Ring_BULB			15,0	19,0	838
841042N	NEW HOLLAND	Schlepper / 2110-8210	5710	O-Ring_BULB			15,0	19,0	838
841042N	NEW HOLLAND	Schlepper / 2110-8210	5900	O-Ring_BULB			15,0	19,0	838
841042N	NEW HOLLAND	Schlepper / 2110-8210	6410	O-Ring_BULB			15,0	19,0	838
841042N	NEW HOLLAND	Schlepper / 2110-8210	6610	O-Ring_BULB			15,0	19,0	838
841042N	NEW HOLLAND	Schlepper / 2110-8210	6710	O-Ring_BULB			15,0	19,0	838
841042N	NEW HOLLAND	Schlepper / 2110-8210	6810	O-Ring_BULB			15,0	19,0	838



Dasis Nr.	Hersteller	Modell	Typ	Spezifikation	Innengewindemaß Druckseite	Innengewindemaß Saugseite	Außengewindemaß Druckseite	Außengewindemaß Saugseite	Kapillarrohrlänge [mm]
841042N	NEW HOLLAND	Schlepper / 2110-8210	7410	O-Ring_BULB			15,0	19,0	838
841042N	NEW HOLLAND	Schlepper / 2110-8210	7610	O-Ring_BULB			15,0	19,0	838
841042N	NEW HOLLAND	Schlepper / 2110-8210	7710	O-Ring_BULB			15,0	19,0	838
841042N	NEW HOLLAND	Schlepper / 2110-8210	7810	O-Ring_BULB			15,0	19,0	838
841042N	NEW HOLLAND	Schlepper / 2110-8210	7910	O-Ring_BULB			15,0	19,0	838
841042N	NEW HOLLAND	Schlepper / 2110-8210	8210	O-Ring_BULB			15,0	19,0	838
841042N	NEW HOLLAND	Schlepper / 3230-8930	3230	O-Ring_BULB			15,0	19,0	838
841042N	NEW HOLLAND	Schlepper / 3230-8930	3430	O-Ring_BULB			15,0	19,0	838
841042N	NEW HOLLAND	Schlepper / 3230-8930	3930	O-Ring_BULB			15,0	19,0	838
841042N	NEW HOLLAND	Schlepper / 3230-8930	3930H	O-Ring_BULB			15,0	19,0	838
841042N	NEW HOLLAND	Schlepper / 3230-8930	4130	O-Ring_BULB			15,0	19,0	838
841042N	NEW HOLLAND	Schlepper / 3230-8930	4330	O-Ring_BULB			15,0	19,0	838
841042N	NEW HOLLAND	Schlepper / 3230-8930	4630	O-Ring_BULB			15,0	19,0	838
841042N	NEW HOLLAND	Schlepper / 3230-8930	4830	O-Ring_BULB			15,0	19,0	838
841042N	NEW HOLLAND	Schlepper / 3230-8930	5030	O-Ring_BULB			15,0	19,0	838
841042N	NEW HOLLAND	Schlepper / 3230-8930	8530	O-Ring_BULB			15,0	19,0	838
841042N	NEW HOLLAND	Schlepper / 3230-8930	8630	O-Ring_BULB			15,0	19,0	838
841042N	NEW HOLLAND	Schlepper / 3230-8930	8730	O-Ring_BULB			15,0	19,0	838
841042N	NEW HOLLAND	Schlepper / 3230-8930	8830	O-Ring_BULB			15,0	19,0	838
840490N	NEW HOLLAND	Schlepper / 3435-7635	3435	O-Ring			16,0	18,0	355
840490N	NEW HOLLAND	Schlepper / 3435-7635	3935	O-Ring			16,0	18,0	355

Dasis Nr.	Hersteller	Modell	Typ	Spezifikation	Innengewindemaß Druckseite	Innengewindemaß Saugseite	Außengewindemaß Druckseite	Außengewindemaß Saugseite	Kapillarrohrlänge [mm]
840490N	NEW HOLLAND	Schlepper / 3435-7635	4135	O-Ring			16,0	18,0	355
840490N	NEW HOLLAND	Schlepper / 3435-7635	4635	O-Ring			16,0	18,0	355
840490N	NEW HOLLAND	Schlepper / 3435-7635	4835	O-Ring			16,0	18,0	355
840490N	NEW HOLLAND	Schlepper / 3435-7635	5635	O-Ring			16,0	18,0	355
840490N	NEW HOLLAND	Schlepper / 3435-7635	6635	O-Ring			16,0	18,0	355
840490N	NEW HOLLAND	Schlepper / 3435-7635	7635	O-Ring			16,0	18,0	355
841042N	NEW HOLLAND	Schlepper /4110-8210	5110	O-Ring_BULB			15,0	19,0	838
841042N	NEW HOLLAND	Schlepper /4110-8210	5610	O-Ring_BULB			15,0	19,0	838
841042N	NEW HOLLAND	Schlepper /4110-8210	6410	O-Ring_BULB			15,0	19,0	838
841042N	NEW HOLLAND	Schlepper /4110-8210	6610	O-Ring_BULB			15,0	19,0	838
841042N	NEW HOLLAND	Schlepper /4110-8210	6810	O-Ring_BULB			15,0	19,0	838
841042N	NEW HOLLAND	Schlepper /4110-8210	7410	O-Ring_BULB			15,0	19,0	838
841042N	NEW HOLLAND	Schlepper /4110-8210	7610	O-Ring_BULB			15,0	19,0	838
841042N	NEW HOLLAND	Schlepper /4110-8210	7710	O-Ring_BULB			15,0	19,0	838
841042N	NEW HOLLAND	Schlepper /4110-8210	7810	O-Ring_BULB			15,0	19,0	838
841042N	NEW HOLLAND	Schlepper /4110-8210	7910	O-Ring_BULB			15,0	19,0	838
841042N	NEW HOLLAND	Schlepper /4110-8210	8210	O-Ring_BULB			15,0	19,0	838
840166N	NEW HOLLAND	Schlepper / 4140-8340	5640	O-Ring					
840166N	NEW HOLLAND	Schlepper / 4140-8340	6640	O-Ring					
840166N	NEW HOLLAND	Schlepper / 4140-8340	7740	O-Ring					
840166N	NEW HOLLAND	Schlepper / 4140-8340	7840	O-Ring					

Dasis Nr.	Hersteller	Modell	Typ	Spezifikation	Innengewindemaß Druckseite	Innengewindemaß Saugseite	Außengewindemaß Druckseite	Außengewindemaß Saugseite	Kapillarrohrlänge [mm]
840166N	NEW HOLLAND	Schlepper / 4140-8340	8240	O-Ring					
840166N	NEW HOLLAND	Schlepper / 4140-8340	8340	O-Ring					
840166N	NEW HOLLAND	Schlepper / 8160-8560	8160	O-Ring					
840166N	NEW HOLLAND	Schlepper / 8160-8560	8260	O-Ring					
840166N	NEW HOLLAND	Schlepper / 8160-8560	8360	O-Ring					
840166N	NEW HOLLAND	Schlepper / 8160-8560	8560	O-Ring					
840086N	NEW HOLLAND	Schlepper / 8670-8970	8670	Innengewinde					
840086N	NEW HOLLAND	Schlepper / 8670-8970	8770	Innengewinde					
840086N	NEW HOLLAND	Schlepper / 8670-8970	8870	Innengewinde					
840086N	NEW HOLLAND	Schlepper / 8670-8970	8970	Innengewinde					
840086N	NEW HOLLAND	Schlepper / 8670A-8970A	8670A	Innengewinde					
840086N	NEW HOLLAND	Schlepper / 8670A-8970A	8770A	Innengewinde					
840086N	NEW HOLLAND	Schlepper / 8670A-8970A	8870A	Innengewinde					
840086N	NEW HOLLAND	Schlepper / 8670A-8970A	8970A	Innengewinde					
840130N	NEW HOLLAND	Schlepper / 9280-9884	9280	O-Ring					
840130N	NEW HOLLAND	Schlepper / 9280-9884	9282	O-Ring					
840130N	NEW HOLLAND	Schlepper / 9280-9884	9384	O-Ring					
840130N	NEW HOLLAND	Schlepper / 9280-9884	9480	O-Ring					
840130N	NEW HOLLAND	Schlepper / 9280-9884	9482	O-Ring					
840130N	NEW HOLLAND	Schlepper / 9280-9884	9484	O-Ring					
840130N	NEW HOLLAND	Schlepper / 9280-9884	9680	O-Ring					

Dasis Nr.	Hersteller	Modell	Typ	Spezifikation	Innengewindemaß Druckseite	Innengewindemaß Saugseite	Außengewindemaß Druckseite	Außengewindemaß Saugseite	Kapillarrohrlänge [mm]
840130N	NEW HOLLAND	Schlepper / 9280-9884	9682	O-Ring					
840130N	NEW HOLLAND	Schlepper / 9280-9884	9684	O-Ring					
840130N	NEW HOLLAND	Schlepper / 9280-9884	9880	O-Ring					
840130N	NEW HOLLAND	Schlepper / 9280-9884	9882	O-Ring					
840130N	NEW HOLLAND	Schlepper / 9280-9884	9884	O-Ring					
840086N	NEW HOLLAND	Schlepper / CX	840	Innengewinde					
840086N	NEW HOLLAND	Schlepper / CX	860	Innengewinde					
840086N	NEW HOLLAND	Schlepper / CX	880	Innengewinde					
840086N	NEW HOLLAND	Schlepper / CX	8030	Innengewinde					
840086N	NEW HOLLAND	Schlepper / CX	8040	Innengewinde					
840086N	NEW HOLLAND	Schlepper / CX	8050	Innengewinde					
840086N	NEW HOLLAND	Schlepper / CX	8060	Innengewinde					
840086N	NEW HOLLAND	Schlepper / CX	8070	Innengewinde					
840086N	NEW HOLLAND	Schlepper / CX	8080	Innengewinde					
840086N	NEW HOLLAND	Schlepper / CX	8090	Innengewinde					
840340N	NEW HOLLAND	Schlepper / FW	20	Konus			15,0	18,0	305
840340N	NEW HOLLAND	Schlepper / FW	30	Konus			15,0	18,0	305
840340N	NEW HOLLAND	Schlepper / FW	40	Konus			15,0	18,0	305
840340N	NEW HOLLAND	Schlepper / FW	60	Konus			15,0	18,0	305
840086N	NEW HOLLAND	Schlepper / G	170	Innengewinde					
840086N	NEW HOLLAND	Schlepper / G	190	Innengewinde					
840086N	NEW HOLLAND	Schlepper / G	210	Innengewinde					
840086N	NEW HOLLAND	Schlepper / G	240	Innengewinde					
840129N	NEW HOLLAND	Schlepper / LB	115						
840037N	NEW HOLLAND	Schlepper / TDD	TD55D	O-Ring	3/8 / 5/8	5/8 / 5/8			
840037N	NEW HOLLAND	Schlepper / TDD	TD60D	O-Ring	3/8 / 5/8	5/8 / 5/8			
840037N	NEW HOLLAND	Schlepper / TDD	TD70D	O-Ring	3/8 / 5/8	5/8 / 5/8			
840037N	NEW HOLLAND	Schlepper / TDD	TD75D	O-Ring	3/8 / 5/8	5/8 / 5/8			
840037N	NEW HOLLAND	Schlepper / TDD	TD80D	O-Ring	3/8 / 5/8	5/8 / 5/8			

Dasis Nr.	Hersteller	Modell	Typ	Spezifikation	Innengewindemaß Druckseite	Innengewindemaß Saugseite	Außengewindemaß Druckseite	Außengewindemaß Saugseite	Kapillarrohrlänge [mm]
840037N	NEW HOLLAND	Schlepper / TDD	TD85D	O-Ring	3/8 / 5/8	5/8 / 5/8			
840037N	NEW HOLLAND	Schlepper / TDD	TD90D	O-Ring	3/8 / 5/8	5/8 / 5/8			
840037N	NEW HOLLAND	Schlepper / TDD	TD95D	O-Ring	3/8 / 5/8	5/8 / 5/8			
840086N	NEW HOLLAND	Schlepper / TG	210	Innengewinde					
840086N	NEW HOLLAND	Schlepper / TG	215	Innengewinde					
840086N	NEW HOLLAND	Schlepper / TG	230	Innengewinde					
840086N	NEW HOLLAND	Schlepper / TG	245	Innengewinde					
840086N	NEW HOLLAND	Schlepper / TG	255	Innengewinde					
840086N	NEW HOLLAND	Schlepper / TG	275	Innengewinde					
840086N	NEW HOLLAND	Schlepper / TG	285	Innengewinde					
840086N	NEW HOLLAND	Schlepper / TG	305	Innengewinde					
840086N	NEW HOLLAND	Schlepper / TJ	275	Innengewinde					
840086N	NEW HOLLAND	Schlepper / TJ	325	Innengewinde					
840086N	NEW HOLLAND	Schlepper / TJ	330	Innengewinde					
840086N	NEW HOLLAND	Schlepper / TJ	355	Innengewinde					
840086N	NEW HOLLAND	Schlepper / TJ	380	Innengewinde					
840086N	NEW HOLLAND	Schlepper / TJ	425	Innengewinde					
840086N	NEW HOLLAND	Schlepper / TJ	430	Innengewinde					
840086N	NEW HOLLAND	Schlepper / TJ	480	Innengewinde					
840086N	NEW HOLLAND	Schlepper / TJ	500	Innengewinde					
840086N	NEW HOLLAND	Schlepper / TJ	550	Innengewinde					
840037N	NEW HOLLAND	Schlepper / TL	70	O-Ring	3/8 / 5/8	5/8 / 5/8			
840037N	NEW HOLLAND	Schlepper / TL	80	O-Ring	3/8 / 5/8	5/8 / 5/8			
840037N	NEW HOLLAND	Schlepper / TL	90	O-Ring	3/8 / 5/8	5/8 / 5/8			
840037N	NEW HOLLAND	Schlepper / TL	100	O-Ring	3/8 / 5/8	5/8 / 5/8			
840490N	NEW HOLLAND	Schlepper / TLA	70A	O-Ring			16,0	18,0	355
840490N	NEW HOLLAND	Schlepper / TLA	80A	O-Ring			16,0	18,0	355
840490N	NEW HOLLAND	Schlepper / TLA	90A	O-Ring			16,0	18,0	355
840490N	NEW HOLLAND	Schlepper / TLA	100A	O-Ring			16,0	18,0	355
840310N	NEW HOLLAND	Schlepper / TM	TM115	O-Ring	3/8 / 1/2	5/8 / 3/4			
840166N	NEW HOLLAND	Schlepper / TM	TM115	O-Ring					

Dasis Nr.	Hersteller	Modell	Typ	Spezifikation	Innengewindemaß Druckseite	Innengewindemaß Saugseite	Außengewindemaß Druckseite	Außengewindemaß Saugseite	Kapillarrohrlänge [mm]
840310N	NEW HOLLAND	Schlepper / TM	TM120	O-Ring	3/8 / 1/2	5/8 / 3/4			
840166N	NEW HOLLAND	Schlepper / TM	TM120	O-Ring					
840166N	NEW HOLLAND	Schlepper / TM	TM125	O-Ring					
840310N	NEW HOLLAND	Schlepper / TM	TM125	O-Ring	3/8 / 1/2	5/8 / 3/4			
840166N	NEW HOLLAND	Schlepper / TM	TM130	O-Ring					
840310N	NEW HOLLAND	Schlepper / TM	TM130	O-Ring	3/8 / 1/2	5/8 / 3/4			
840310N	NEW HOLLAND	Schlepper / TM	TM135	O-Ring	3/8 / 1/2	5/8 / 3/4			
840166N	NEW HOLLAND	Schlepper / TM	TM135	O-Ring					
840166N	NEW HOLLAND	Schlepper / TM	TM140	O-Ring					
840310N	NEW HOLLAND	Schlepper / TM	TM140	O-Ring	3/8 / 1/2	5/8 / 3/4			
840166N	NEW HOLLAND	Schlepper / TM	TM150	O-Ring					
840310N	NEW HOLLAND	Schlepper / TM	TM150	O-Ring	3/8 / 1/2	5/8 / 3/4			
840310N	NEW HOLLAND	Schlepper / TM	TM155	O-Ring	3/8 / 1/2	5/8 / 3/4			
840166N	NEW HOLLAND	Schlepper / TM	TM155	O-Ring					
840310N	NEW HOLLAND	Schlepper / TM	TM165	O-Ring	3/8 / 1/2	5/8 / 3/4			
840166N	NEW HOLLAND	Schlepper / TM	TM165	O-Ring					
840310N	NEW HOLLAND	Schlepper / TM	TM175	O-Ring	3/8 / 1/2	5/8 / 3/4			
840166N	NEW HOLLAND	Schlepper / TM	TM175	O-Ring					
840310N	NEW HOLLAND	Schlepper / TM	TM190	O-Ring	3/8 / 1/2	5/8 / 3/4			
840166N	NEW HOLLAND	Schlepper / TM	TM190	O-Ring					
840166N	NEW HOLLAND	Schlepper / TS	80	O-Ring					
840166N	NEW HOLLAND	Schlepper / TS	90	O-Ring					
840166N	NEW HOLLAND	Schlepper / TS	100	O-Ring					
840166N	NEW HOLLAND	Schlepper / TS	110	O-Ring					
840166N	NEW HOLLAND	Schlepper / TS	115	O-Ring					
840162N	NEW HOLLAND	Schlepper / TSA	100A						
840162N	NEW HOLLAND	Schlepper / TSA	110A						
840162N	NEW HOLLAND	Schlepper / TSA	115A						
840162N	NEW HOLLAND	Schlepper / TSA	125A						
840162N	NEW HOLLAND	Schlepper / TSA	135A						
840130N	NEW HOLLAND	Schlepper / TV	140	O-Ring					

Dasis Nr.	Hersteller	Modell	Typ	Spezifikation	Innengewindemaß Druckseite	Innengewindemaß Saugseite	Außengewindemaß Druckseite	Außengewindemaß Saugseite	Kapillarrohrlänge [mm]
840130N	NEW HOLLAND	Schlepper / TV	145	O-Ring					
840084N	NEW HOLLAND	Schlepper / TW	10				16	18	305
840084N	NEW HOLLAND	Schlepper / TW	20				16	18	305
840084N	NEW HOLLAND	Schlepper / TW	30				16	18	305
840084N	NEW HOLLAND	Schlepper / TW5	5				16	18	305
840084N	NEW HOLLAND	Schlepper / TW5	15				16	18	305
840084N	NEW HOLLAND	Schlepper / TW5	25				16	18	305
840084N	NEW HOLLAND	Schlepper / TW5	35				16	18	305
840490N	NEW HOLLAND	Schlepper Wein Obst / TN	55	O-Ring			16,0	18,0	355
840490N	NEW HOLLAND	Schlepper Wein Obst / TN	65	O-Ring			16,0	18,0	355
840490N	NEW HOLLAND	Schlepper Wein Obst / TN	70	O-Ring			16,0	18,0	355
840490N	NEW HOLLAND	Schlepper Wein Obst / TN	75	O-Ring			16,0	18,0	355
840490N	NEW HOLLAND	Schlepper Wein Obst / TND	55	O-Ring			16,0	18,0	355
840490N	NEW HOLLAND	Schlepper Wein Obst / TND	65	O-Ring			16,0	18,0	355
840490N	NEW HOLLAND	Schlepper Wein Obst / TND	70	O-Ring			16,0	18,0	355
840490N	NEW HOLLAND	Schlepper Wein Obst / TND	75	O-Ring			16,0	18,0	355
840490N	NEW HOLLAND	Schlepper Wein Obst / TNF	65	O-Ring			16,0	18,0	355
840490N	NEW HOLLAND	Schlepper Wein Obst / TNF	70	O-Ring			16,0	18,0	355
840490N	NEW HOLLAND	Schlepper Wein Obst / TNF	75	O-Ring			16,0	18,0	355
840490N	NEW HOLLAND	Schlepper Wein Obst / TNF	80	O-Ring			16,0	18,0	355
840490N	NEW HOLLAND	Schlepper Wein Obst / TNF	90	O-Ring			16,0	18,0	355
840490N	NEW HOLLAND	Schlepper Wein Obst / TNF	95	O-Ring			16,0	18,0	355
840490N	NEW HOLLAND	Schlepper Wein Obst / TNS	55	O-Ring			16,0	18,0	355
840490N	NEW HOLLAND	Schlepper Wein Obst / TNS	65	O-Ring			16,0	18,0	355

Dasis Nr.	Hersteller	Modell	Typ	Spezifikation	Innengewindemaß Druckseite	Innengewindemaß Saugseite	Außengewindemaß Druckseite	Außengewindemaß Saugseite	Kapillarrohrlänge [mm]
840490N	NEW HOLLAND	Schlepper Wein Obst / TNS	70	O-Ring			16,0	18,0	355
840490N	NEW HOLLAND	Schlepper Wein Obst / TNS	75	O-Ring			16,0	18,0	355
841042N	NEW HOLLAND	Schlepper Wein Obst / TW	5	O-Ring_BULB			15,0	19,0	838
841042N	NEW HOLLAND	Schlepper Wein Obst / TW	25	O-Ring_BULB			15,0	19,0	838
841042N	NEW HOLLAND	Schlepper Wein Obst / TW	30	O-Ring_BULB			15,0	19,0	838
841042N	NEW HOLLAND	Schlepper Wein Obst / TW	35	O-Ring_BULB			15,0	19,0	838
840158N	Renault	Schlepper / Ares 500	531S						
840158N	Renault	Schlepper / Ares 500	540						
840158N	Renault	Schlepper / Ares 500	546						
840158N	Renault	Schlepper / Ares 500	550						
840158N	Renault	Schlepper / Ares 500	556						
840158N	Renault	Schlepper / Ares 500	560						
840158N	Renault	Schlepper / Ares 500	566						
840158N	Renault	Schlepper / Ares 600	610						
840158N	Renault	Schlepper / Ares 600	616						
840158N	Renault	Schlepper / Ares 600	620						
840158N	Renault	Schlepper / Ares 600	626						
840158N	Renault	Schlepper / Ares 600	630						
840158N	Renault	Schlepper / Ares 600	636						
840158N	Renault	Schlepper / Ares 600	640						
840158N	Renault	Schlepper / Ares 600	696						
840158N	Renault	Schlepper / Ares 700	710						
840158N	Renault	Schlepper / Ares 700	715						
840158N	Renault	Schlepper / Ares 700	720						
840158N	Renault	Schlepper / Ares 700	725						
840158N	Renault	Schlepper / Ares 700	735						
840158N	Renault	Schlepper / Ares 800	815						
840158N	Renault	Schlepper / Ares 800	816						
840158N	Renault	Schlepper / Ares 800	825						



Dasis Nr.	Hersteller	Modell	Typ	Spezifikation	Innengewindemaß Druckseite	Innengewindemaß Saugseite	Außengewindemaß Druckseite	Außengewindemaß Saugseite	Kapillarrohrlänge [mm]
840158N	Renault	Schlepper / Ares 800	826						
840158N	Renault	Schlepper / Ares 800	836						
840660N	Renault	Schlepper / Ceres	310	O-Ring					
840660N	Renault	Schlepper / Ceres	320	O-Ring					
840660N	Renault	Schlepper / Ceres	325	O-Ring					
840660N	Renault	Schlepper / Ceres	330	O-Ring					
840120N	Renault	Schlepper / Ceres	330	O-Ring					
840660N	Renault	Schlepper / Ceres	335	O-Ring					
840120N	Renault	Schlepper / Ceres	335	O-Ring					
840660N	Renault	Schlepper / Ceres	340	O-Ring					
840120N	Renault	Schlepper / Ceres	340	O-Ring					
840120N	Renault	Schlepper / Ceres	345	O-Ring					
840660N	Renault	Schlepper / Ceres	345	O-Ring					
840660N	Renault	Schlepper / Ceres	355	O-Ring					
840120N	Renault	Schlepper / Ceres	355	O-Ring					
840120N	Renault	Schlepper / Cergos	330	O-Ring					
840120N	Renault	Schlepper / Cergos	335	O-Ring					
840120N	Renault	Schlepper / Cergos	340	O-Ring					
840120N	Renault	Schlepper / Cergos	345	O-Ring					
840120N	Renault	Schlepper / Cergos	350	O-Ring					
840120N	Renault	Schlepper / Cergos	355	O-Ring					
840120N	Renault	Schlepper / Ergos	85	O-Ring					
840120N	Renault	Schlepper / Ergos	85-4	O-Ring					
840120N	Renault	Schlepper / Ergos	90	O-Ring					
840120N	Renault	Schlepper / Ergos	90-4	O-Ring					
840120N	Renault	Schlepper / Ergos	95	O-Ring					
840120N	Renault	Schlepper / Ergos	95-4	O-Ring					
840120N	Renault	Schlepper / Ergos	95-4PJVHyro	O-Ring					
840120N	Renault	Schlepper / Ergos	95PJVHyro	O-Ring					
840120N	Renault	Schlepper / Ergos	100	O-Ring					
840120N	Renault	Schlepper / Ergos	100-4	O-Ring					

Dasis Nr.	Hersteller	Modell	Typ	Spezifikation	Innengewindemaß Druckseite	Innengewindemaß Saugseite	Außengewindemaß Druckseite	Außengewindemaß Saugseite	Kapillarrohrlänge [mm]
840120N	Renault	Schlepper / Ergos	100-4P	O-Ring					
840120N	Renault	Schlepper / Ergos	100-4PJVHyro	O-Ring					
840120N	Renault	Schlepper / Ergos	100P	O-Ring					
840120N	Renault	Schlepper / Ergos	100PJVHyro	O-Ring					
840120N	Renault	Schlepper / Ergos	105	O-Ring					
840120N	Renault	Schlepper / Ergos	105-4	O-Ring					
840120N	Renault	Schlepper / Ergos	105-4P	O-Ring					
840120N	Renault	Schlepper / Ergos	105-4PJVHyro	O-Ring					
840120N	Renault	Schlepper / Ergos	105PJVHyro	O-Ring					
840120N	Renault	Schlepper / Ergos	110	O-Ring					
840120N	Renault	Schlepper / Ergos	110-4	O-Ring					
840120N	Renault	Schlepper / Ergos	110-4P	O-Ring					
840120N	Renault	Schlepper / Ergos	110-4PJVHyro	O-Ring					
840120N	Renault	Schlepper / Ergos	110P	O-Ring					
840120N	Renault	Schlepper / Ergos	110PJVHyro	O-Ring					
840120N	Renault	Schlepper / Ergos	436	O-Ring					
840120N	Renault	Schlepper / Ergos	436-4	O-Ring					
840120N	Renault	Schlepper / Ergos	436-4Meca	O-Ring					
840120N	Renault	Schlepper / Ergos	436Meca	O-Ring					
840120N	Renault	Schlepper / Ergos	446	O-Ring					
840120N	Renault	Schlepper / Ergos	446-4	O-Ring					
840120N	Renault	Schlepper / Ergos	446-4Meca	O-Ring					
840120N	Renault	Schlepper / Ergos	446-4P	O-Ring					
840120N	Renault	Schlepper / Ergos	446-4PJVHyro	O-Ring					
840120N	Renault	Schlepper / Ergos	446Meca	O-Ring					
840120N	Renault	Schlepper / Ergos	446P	O-Ring					
840120N	Renault	Schlepper / Ergos	446PJVHyro	O-Ring					
840120N	Renault	Schlepper / Ergos	456	O-Ring					
840120N	Renault	Schlepper / Ergos	456-4	O-Ring					
840120N	Renault	Schlepper / Ergos	456-4Meca	O-Ring					
840120N	Renault	Schlepper / Ergos	456-4P	O-Ring					

Dasis Nr.	Hersteller	Modell	Typ	Spezifikation	Innengewindemaß Druckseite	Innengewindemaß Saugseite	Außengewindemaß Druckseite	Außengewindemaß Saugseite	Kapillarrohrlänge [mm]
840120N	Renault	Schlepper / Ergos	456-4PJVHyro	O-Ring					
840120N	Renault	Schlepper / Ergos	456Meca	O-Ring					
840120N	Renault	Schlepper / Ergos	456P	O-Ring					
840120N	Renault	Schlepper / Ergos	456PJVHyro	O-Ring					
840120N	Renault	Schlepper / Ergos	466	O-Ring					
840120N	Renault	Schlepper / Ergos	466-4	O-Ring					
840120N	Renault	Schlepper / Ergos	466-4Meca	O-Ring					
840120N	Renault	Schlepper / Ergos	466-4P	O-Ring					
840120N	Renault	Schlepper / Ergos	466-4PJVHyro	O-Ring					
840120N	Renault	Schlepper / Ergos	466Meca	O-Ring					
840120N	Renault	Schlepper / Ergos	466P	O-Ring					
840120N	Renault	Schlepper / Ergos	466PJVHyro	O-Ring					
840370N	Renault	Schlepper / LB	50-12				16	18	
840370N	Renault	Schlepper / LB	55-12				16	18	
840370N	Renault	Schlepper / LB	55-14				16	18	
840370N	Renault	Schlepper / LB	70-12				16	18	
840370N	Renault	Schlepper / LB	70-14				16	18	
840130N	Renault	Schlepper / ME	58-32ME	O-Ring					
840130N	Renault	Schlepper / ME	58-34ME	O-Ring					
840130N	Renault	Schlepper / ME	65-32ME	O-Ring					
840130N	Renault	Schlepper / ME	65-34ME	O-Ring					
840130N	Renault	Schlepper / ME	75-12ME	O-Ring					
840130N	Renault	Schlepper / ME	75-32ME	O-Ring					
840130N	Renault	Schlepper / ME	75-34ME	O-Ring					
840130N	Renault	Schlepper / ME	85-32ME	O-Ring					
840130N	Renault	Schlepper / ME	85-34ME	O-Ring					
840130N	Renault	Schlepper / ME	90-32ME	O-Ring					
840130N	Renault	Schlepper / ME	90-34ME	O-Ring					
840130N	Renault	Schlepper / ME	110-14ME	O-Ring					
840130N	Renault	Schlepper / ME	120-14ME	O-Ring					
840130N	Renault	Schlepper / ME	133-14ME	O-Ring					

Dasis Nr.	Hersteller	Modell	Typ	Spezifikation	Innengewindemaß Druckseite	Innengewindemaß Saugseite	Außengewindemaß Druckseite	Außengewindemaß Saugseite	Kapillarrohrlänge [mm]
840130N	Renault	Schlepper / ME	145-14ME	O-Ring					
840130N	Renault	Schlepper / RE	95-12RE	O-Ring					
840130N	Renault	Schlepper / RE	95-14RE	O-Ring					
840130N	Renault	Schlepper / RE	103-12RE	O-Ring					
840130N	Renault	Schlepper / RE	103-14RE	O-Ring					
840130N	Renault	Schlepper / RE	110-14RE	O-Ring					
840130N	Renault	Schlepper / RE	113-12RE	O-Ring					
840130N	Renault	Schlepper / RE	113-14RE	O-Ring					
840130N	Renault	Schlepper / RE	120-14RE	O-Ring					
840130N	Renault	Schlepper / RE	133-14RE	O-Ring					
840130N	Renault	Schlepper / RE	145-14RE	O-Ring					
840130N	Renault	Schlepper / RS	61-12	O-Ring					
840130N	Renault	Schlepper / RS	61-14	O-Ring					
840130N	Renault	Schlepper / RS	68-12	O-Ring					
840130N	Renault	Schlepper / RS	68-14	O-Ring					
840130N	Renault	Schlepper / RS	75-12	O-Ring					
840130N	Renault	Schlepper / RS	75-14	O-Ring					
840130N	Renault	Schlepper / RS	95-12	O-Ring					
840130N	Renault	Schlepper / RS	95-14	O-Ring					
840130N	Renault	Schlepper / RS	103-12	O-Ring					
840130N	Renault	Schlepper / RS	103-14	O-Ring					
840130N	Renault	Schlepper / SP	70-12	O-Ring					
840130N	Renault	Schlepper / SP	70-14	O-Ring					
840130N	Renault	Schlepper / SP	80-12	O-Ring					
840130N	Renault	Schlepper / SP	80-14	O-Ring					
840130N	Renault	Schlepper / SP	106-14	O-Ring					
840130N	Renault	Schlepper / TA	103-52	O-Ring					
840130N	Renault	Schlepper / TA	103-54	O-Ring					
840130N	Renault	Schlepper / TA	110-14	O-Ring					
840130N	Renault	Schlepper / TA	110-54	O-Ring					
840130N	Renault	Schlepper / TA	120-14	O-Ring					

Dasis Nr.	Hersteller	Modell	Typ	Spezifikation	Innengewindemaß Druckseite	Innengewindemaß Saugseite	Außengewindemaß Druckseite	Außengewindemaß Saugseite	Kapillarrohrlänge [mm]
840130N	Renault	Schlepper / TA	120-54	O-Ring					
840130N	Renault	Schlepper / TA	133-14	O-Ring					
840130N	Renault	Schlepper / TA	133-54	O-Ring					
840130N	Renault	Schlepper / TA	145-14	O-Ring					
840130N	Renault	Schlepper / TA	145-54	O-Ring					
840130N	Renault	Schlepper / TA	155-54	O-Ring					
840130N	Renault	Schlepper / TE	103-52TE	O-Ring					
840130N	Renault	Schlepper / TE	103-54TE	O-Ring					
840130N	Renault	Schlepper / TE	110-14TE	O-Ring					
840130N	Renault	Schlepper / TE	110-54TE	O-Ring					
840130N	Renault	Schlepper / TE	120-14TE	O-Ring					
840130N	Renault	Schlepper / TE	120-54TE	O-Ring					
840130N	Renault	Schlepper / TE	133-14TE	O-Ring					
840130N	Renault	Schlepper / TE	133-54TE	O-Ring					
840130N	Renault	Schlepper / TE	145-14TE	O-Ring					
840130N	Renault	Schlepper / TE	145-54TE	O-Ring					
840130N	Renault	Schlepper / TE	155-54TE	O-Ring					
840130N	Renault	Schlepper / TL	106-54	O-Ring					
840130N	Renault	Schlepper / TS	75-12	O-Ring					
840130N	Renault	Schlepper / TS	75-14	O-Ring					
840130N	Renault	Schlepper / TS	77-12	O-Ring					
840130N	Renault	Schlepper / TS	77-14	O-Ring					
840130N	Renault	Schlepper / TS	85-12	O-Ring					
840130N	Renault	Schlepper / TS	85-14	O-Ring					
840130N	Renault	Schlepper / TS	95-12	O-Ring					
840130N	Renault	Schlepper / TS	95-14	O-Ring					
840130N	Renault	Schlepper / TS	103-12	O-Ring					
840130N	Renault	Schlepper / TS	103-14	O-Ring					
840130N	Renault	Schlepper / TS	103-52	O-Ring					
840130N	Renault	Schlepper / TS	103-54	O-Ring					
840130N	Renault	Schlepper / TS	106-54	O-Ring					

Dasis Nr.	Hersteller	Modell	Typ	Spezifikation	Innengewindemaß Druckseite	Innengewindemaß Saugseite	Außengewindemaß Druckseite	Außengewindemaß Saugseite	Kapillarrohrlänge [mm]
840130N	Renault	Schlepper / TS	110-14	O-Ring					
840130N	Renault	Schlepper / TS	110-54	O-Ring					
840130N	Renault	Schlepper / TS	113-12	O-Ring					
840130N	Renault	Schlepper / TS	113-14	O-Ring					
840130N	Renault	Schlepper / TS	120-14	O-Ring					
840130N	Renault	Schlepper / TS	120-54	O-Ring					
840130N	Renault	Schlepper / TS	133-12	O-Ring					
840130N	Renault	Schlepper / TS	133-14	O-Ring					
840130N	Renault	Schlepper / TS	133-54	O-Ring					
840130N	Renault	Schlepper / TX	75-32TX	O-Ring					
840130N	Renault	Schlepper / TX	75-34TX	O-Ring					
840130N	Renault	Schlepper / TX	80-12TX	O-Ring					
840130N	Renault	Schlepper / TX	80-14TX	O-Ring					
840130N	Renault	Schlepper / TX	85-12TX	O-Ring					
840130N	Renault	Schlepper / TX	85-14TX	O-Ring					
840130N	Renault	Schlepper / TX	85-32TX	O-Ring					
840130N	Renault	Schlepper / TX	85-34TX	O-Ring					
840130N	Renault	Schlepper / TX	90-32TX	O-Ring					
840130N	Renault	Schlepper / TX	90-34TX	O-Ring					
840130N	Renault	Schlepper / TX	95-12TX	O-Ring					
840130N	Renault	Schlepper / TX	95-14TX	O-Ring					
840130N	Renault	Schlepper / TX	103-12TX	O-Ring					
840130N	Renault	Schlepper / TX	103-14TX	O-Ring					
840130N	Renault	Schlepper / TX	103-52TX	O-Ring					
840130N	Renault	Schlepper / TX	103-54TX	O-Ring					
840130N	Renault	Schlepper / TX	106-54TX	O-Ring					
840130N	Renault	Schlepper / TX	110-14TX	O-Ring					
840130N	Renault	Schlepper / TX	110-54TX	O-Ring					
840130N	Renault	Schlepper / TX	113-12TX	O-Ring					
840130N	Renault	Schlepper / TX	113-14TX	O-Ring					
840130N	Renault	Schlepper / TX	120-14TX	O-Ring					

Dasis Nr.	Hersteller	Modell	Typ	Spezifikation	Innengewindemaß Druckseite	Innengewindemaß Saugseite	Außengewindemaß Druckseite	Außengewindemaß Saugseite	Kapillarrohrlänge [mm]
840130N	Renault	Schlepper / TX	133-12TX	O-Ring					
840130N	Renault	Schlepper / TX	133-14TX	O-Ring					
840130N	Renault	Schlepper / TX	133-54TX	O-Ring					
840130N	Renault	Schlepper / TX	145-14TX	O-Ring					
840130N	Renault	Schlepper / TX	145-54TX	O-Ring					
840130N	Renault	Schlepper / TZ	110-54TZ	O-Ring					
840130N	Renault	Schlepper / TZ	120-14TZ	O-Ring					
840130N	Renault	Schlepper / TZ	120-54TZ	O-Ring					
840130N	Renault	Schlepper / TZ	133-14TZ	O-Ring					
840130N	Renault	Schlepper / TZ	133-54TZ	O-Ring					
840130N	Renault	Schlepper / TZ	145-14TZ	O-Ring					
840130N	Renault	Schlepper / TZ	145-54TZ	O-Ring					
840130N	Renault	Schlepper / TZ	155-54TZ	O-Ring					
840130N	Renault	Schlepper / TZ	160-94TZ	O-Ring					
840130N	Renault	Schlepper / TZ	175-74TZ	O-Ring					
840130N	Renault	Schlepper / TZ	180-94TZ	O-Ring					
840130N	Renault	Schlepper Obst Wein / TZ	160-94	O-Ring					
840130N	Renault	Schlepper Obst Wein / TZ	175-74	O-Ring					
840130N	Renault	Schlepper Obst Wein / TZ	180-94	O-Ring					
840037N	Same	Schlepper / Dorado	55	O-Ring	3/8 / 5/8	5/8 / 5/8			
840037N	Same	Schlepper / Dorado	56	O-Ring	3/8 / 5/8	5/8 / 5/8			
840037N	Same	Schlepper / Dorado	60	O-Ring	3/8 / 5/8	5/8 / 5/8			
840037N	Same	Schlepper / Dorado	65	O-Ring	3/8 / 5/8	5/8 / 5/8			
840037N	Same	Schlepper / Dorado	66	O-Ring	3/8 / 5/8	5/8 / 5/8			
840037N	Same	Schlepper / Dorado	70	O-Ring	3/8 / 5/8	5/8 / 5/8			
840037N	Same	Schlepper / Dorado	75	O-Ring	3/8 / 5/8	5/8 / 5/8			
840037N	Same	Schlepper / Dorado	76	O-Ring	3/8 / 5/8	5/8 / 5/8			
840037N	Same	Schlepper / Dorado	85	O-Ring	3/8 / 5/8	5/8 / 5/8			
840037N	Same	Schlepper / Dorado	86	O-Ring	3/8 / 5/8	5/8 / 5/8			
840037N	Same	Schlepper / Dorado	90	O-Ring	3/8 / 5/8	5/8 / 5/8			

Dasis Nr.	Hersteller	Modell	Typ	Spezifikation	Innengewindemaß Druckseite	Innengewindemaß Saugseite	Außengewindemaß Druckseite	Außengewindemaß Saugseite	Kapillarrohrlänge [mm]
840037N	Same	Schlepper / Dorado	100	O-Ring	3/8 / 5/8	5/8 / 5/8			
840037N	Same	Schlepper / Dorado	708	O-Ring	3/8 / 5/8	5/8 / 5/8			
840037N	Same	Schlepper / Iron	100	O-Ring	3/8 / 5/8	5/8 / 5/8			
840037N	Same	Schlepper / Iron	110	O-Ring	3/8 / 5/8	5/8 / 5/8			
840037N	Same	Schlepper / Iron	115	O-Ring	3/8 / 5/8	5/8 / 5/8			
840037N	Same	Schlepper / Iron	125	O-Ring	3/8 / 5/8	5/8 / 5/8			
840037N	Same	Schlepper / Iron	140	O-Ring	3/8 / 5/8	5/8 / 5/8			
840037N	Same	Schlepper / Iron	160	O-Ring	3/8 / 5/8	5/8 / 5/8			
840037N	Same	Schlepper / Iron	170	O-Ring	3/8 / 5/8	5/8 / 5/8			
840037N	Same	Schlepper / Iron	175	O-Ring	3/8 / 5/8	5/8 / 5/8			
840037N	Same	Schlepper / Iron	185	O-Ring	3/8 / 5/8	5/8 / 5/8			
840130N	Steyr	Schlepper / CS	78	O-Ring					
840130N	Steyr	Schlepper / CS	86	O-Ring					
840130N	Steyr	Schlepper / CS	94	O-Ring					
840130N	Steyr	Schlepper / CS	100	O-Ring					
840130N	Steyr	Schlepper / CS	110	O-Ring					
840130N	Steyr	Schlepper / CS	120	O-Ring					
840130N	Steyr	Schlepper / CS	130	O-Ring					
840130N	Steyr	Schlepper / CS	150	O-Ring					
840130N	Steyr	Schlepper / CVT	3135	O-Ring					
840130N	Steyr	Schlepper / CVT	6145	O-Ring					
840130N	Steyr	Schlepper / CVT	6155	O-Ring					
840130N	Steyr	Schlepper / CVT	6170	O-Ring					
840130N	Steyr	Schlepper / CVT	6190	O-Ring					
840130N	Steyr	Schlepper / M	9078	O-Ring					
840130N	Steyr	Schlepper / M	9086	O-Ring					
840130N	Steyr	Schlepper / M	9094	O-Ring					
840130N	Steyr	Schlepper / M	9105	O-Ring					
840130N	Steyr	Schlepper / M	9115	O-Ring					
840130N	Steyr	Schlepper / M	9125	O-Ring					
840130N	Steyr	Schlepper / M	9145	O-Ring					



Dasis Nr.	Hersteller	Modell	Typ	Spezifikation	Innengewindemaß Druckseite	Innengewindemaß Saugseite	Außengewindemaß Druckseite	Außengewindemaß Saugseite	Kapillarrohrlänge [mm]
840130N	Valtra Valmet	Schlepper / 6000	6000	O-Ring					
840130N	Valtra Valmet	Schlepper / 6000	6200	O-Ring					
840130N	Valtra Valmet	Schlepper / 6000	6800	O-Ring					
840130N	Valtra Valmet	Schlepper / 6000	6900	O-Ring					
840130N	Valtra Valmet	Schlepper / 8000	8050	O-Ring					
840130N	Valtra Valmet	Schlepper / 8000	8200	O-Ring					
840130N	Valtra Valmet	Schlepper / 8000	8300T	O-Ring					
840130N	Valtra Valmet	Schlepper / 8000	8400	O-Ring					
840130N	Valtra Valmet	Schlepper / 8000	8750	O-Ring					
840130N	Valtra Valmet	Schlepper / 8000	8800	O-Ring					
840130N	Valtra Valmet	Schlepper / A	85	O-Ring					
840130N	Valtra Valmet	Schlepper / A	120	O-Ring					
840130N	Valtra Valmet	Schlepper / A	120E	O-Ring					
840130N	Valtra Valmet	Schlepper / HI	6250	O-Ring					
840130N	Valtra Valmet	Schlepper / HI	6550	O-Ring					
840130N	Valtra Valmet	Schlepper / HI	6650	O-Ring					
840130N	Valtra Valmet	Schlepper / HI	6850	O-Ring					
840100N	Volvo	Baggerlader / 600	616B	O-Ring			3/8	1/2	419
840100N	Volvo	Baggerlader / 600	646	O-Ring			3/8	1/2	419
840006N	Volvo	Baggerlader / 4300-4000	4200	O-Ring			15 mm	19 mm	230
840006N	Volvo	Baggerlader / 4300-4000	4300	O-Ring			15 mm	19 mm	230
840006N	Volvo	Schaufellader / 2600	2650	O-Ring			15 mm	19 mm	230
840006N	Volvo	Schaufellader / 2600	2654	O-Ring			15 mm	19 mm	230
840370N	Volvo	Schaufellader / L	50				16	18	
840006N	Volvo	Schaufellader / L	50	O-Ring			15 mm	19 mm	230
840370N	Volvo	Schaufellader / L	70				16	18	
840006N	Volvo	Schaufellader / L	70	O-Ring			15 mm	19 mm	230
840370N	Volvo	Schaufellader / L	90				16	18	
840006N	Volvo	Schaufellader / L	90	O-Ring			15 mm	19 mm	230
840370N	Volvo	Schaufellader / L	120				16	18	
840006N	Volvo	Schaufellader / L	120	O-Ring			15 mm	19 mm	230

Dasis Nr.	Hersteller	Modell	Typ	Spezifikation	Innengewindemaß Druckseite	Innengewindemaß Saugseite	Außengewindemaß Druckseite	Außengewindemaß Saugseite	Kapillarrohrlänge [mm]
840006N	Volvo	Schaufellader / L	150	O-Ring			15 mm	19 mm	230
840370N	Volvo	Schaufellader / L	170				16	18	
840006N	Volvo	Schaufellader / L	170	O-Ring			15 mm	19 mm	230
840006N	Volvo	Schlepper / 2000- 2654	2650	O-Ring			15 mm	19 mm	230
840006N	Volvo	Schlepper / 2000- 2654	2654	O-Ring			15 mm	19 mm	230

Dasis Nr.	Hersteller	Modell	Typ	Spannung [V]	für OE-Nummer
448174N	Case International IHC	Baggerlader / Maxxum	5120		
448174N	Case International IHC	Baggerlader / Maxxum	5130		
448174N	Case International IHC	Baggerlader / Maxxum	5140		
448174N	Case International IHC	Baggerlader / Maxxum	5220		
448174N	Case International IHC	Baggerlader / Maxxum	5230		
448174N	Case International IHC	Baggerlader / Maxxum	5240		
448174N	Case International IHC	Baggerlader / Maxxum	5250		
740825N	Case International IHC	Schlepper / 186-996	856	12	
740825N	Case International IHC	Schlepper / 186-996	955	12	
740825N	Case International IHC	Schlepper / 186-996	956	12	
740825N	Case International IHC	Schlepper / 1046-1896	1055	12	
740825N	Case International IHC	Schlepper / 1046-1896	1056	12	
740825N	Case International IHC	Schlepper / 1046-1896	1255	12	
740825N	Case International IHC	Schlepper / 1046-1896	1455	12	
740825N	Case International IHC	Schlepper / 4000-4894	4210	12	
740825N	Case International IHC	Schlepper / 4000-4894	4220	12	
740825N	Case International IHC	Schlepper / 4000-4894	4230	12	
740825N	Case International IHC	Schlepper / 4000-4894	4240	12	
448174N	Case International IHC	Schlepper / 7110-7488	7110		
448174N	Case International IHC	Schlepper / 7110-7488	7120		
448174N	Case International IHC	Schlepper / 7110-7488	7130		
448174N	Case International IHC	Schlepper / 7110-7488	7140		
448174N	Case International IHC	Schlepper / 7110-7488	7210		
448174N	Case International IHC	Schlepper / 7110-7488	7220		
740825N	Case International IHC	Schlepper / 7110-7488	7220	12	
448174N	Case International IHC	Schlepper / 7110-7488	7230		
740825N	Case International IHC	Schlepper / 7110-7488	7230	12	
448174N	Case International IHC	Schlepper / 7110-7488	7240		
740825N	Case International IHC	Schlepper / 7110-7488	7240	12	
448205N	Case International IHC	Schlepper / CS	78	12	134684125 134684473
448205N	Case International IHC	Schlepper / CS	80	12	134684125 134684473
448205N	Case International IHC	Schlepper / CS	86	12	134684125 134684473

Dasis Nr.	Hersteller	Modell	Typ	Spannung [V]	für OE-Nummer
448205N	Case International IHC	Schlepper / CS	90	12	134684125 134684473
448205N	Case International IHC	Schlepper / CS	94	12	134684125 134684473
448205N	Case International IHC	Schlepper / CS	100	12	134684125 134684473
448205N	Case International IHC	Schlepper / CS	110	12	134684125 134684473
448205N	Case International IHC	Schlepper / CS	120	12	134684125 134684473
448205N	Case International IHC	Schlepper / CS	130	12	134684125 134684473
448205N	Case International IHC	Schlepper / CS	150	12	134684125 134684473
448205N	Case International IHC	Schlepper / CVX	V120	12	134684125 134684473
448205N	Case International IHC	Schlepper / CVX	V130	12	134684125 134684473
448205N	Case International IHC	Schlepper / CVX	V150	12	134684125 134684473
448205N	Case International IHC	Schlepper / CVX	V170	12	134684125 134684473
448205N	Case International IHC	Schlepper / CVX	V1135	12	134684125 134684473
448205N	Case International IHC	Schlepper / CVX	V1145	12	134684125 134684473
448205N	Case International IHC	Schlepper / CVX	V1155	12	134684125 134684473
448205N	Case International IHC	Schlepper / CVX	V1170	12	134684125 134684473
448205N	Case International IHC	Schlepper / CVX	V1190	12	134684125 134684473
740824N	Case International IHC	Schlepper / CX	50	12	
740824N	Case International IHC	Schlepper / CX	60	12	
740824N	Case International IHC	Schlepper / CX	70	12	
740824N	Case International IHC	Schlepper / CX	80	12	
740824N	Case International IHC	Schlepper / CX	90	12	
740824N	Case International IHC	Schlepper / CX	100	12	
740823N	Case International IHC	Schlepper / JX	55		
740823N	Case International IHC	Schlepper / JX	60		
740823N	Case International IHC	Schlepper / JX	65		
740823N	Case International IHC	Schlepper / JX	70		
740823N	Case International IHC	Schlepper / JX	75		
740823N	Case International IHC	Schlepper / JX	80		
740823N	Case International IHC	Schlepper / JX	85		
740823N	Case International IHC	Schlepper / JX	90		
740823N	Case International IHC	Schlepper / JX	95		
740822N	Case International IHC	Schlepper / JXU	70U	24	

Dasis Nr.	Hersteller	Modell	Typ	Spannung [V]	für OE-Nummer
740822N	Case International IHC	Schlepper / JXU	80U	24	
740822N	Case International IHC	Schlepper / JXU	90U	24	
740822N	Case International IHC	Schlepper / JXU	100U	24	
740822N	Case International IHC	Schlepper / JXU	1070U	24	
740822N	Case International IHC	Schlepper / JXU	1080U	24	
740822N	Case International IHC	Schlepper / JXU	1090U	24	
740822N	Case International IHC	Schlepper / JXU	1100U	24	
448174N	Case International IHC	Schlepper / Magnum	7110		
448174N	Case International IHC	Schlepper / Magnum	7120		
448174N	Case International IHC	Schlepper / Magnum	7130		
448174N	Case International IHC	Schlepper / Magnum	7140		
448174N	Case International IHC	Schlepper / Magnum	7150		
448174N	Case International IHC	Schlepper / Magnum	7210		
448174N	Case International IHC	Schlepper / Magnum	7220		
740825N	Case International IHC	Schlepper / Magnum	7220	12	
448174N	Case International IHC	Schlepper / Magnum	7230		
740825N	Case International IHC	Schlepper / Magnum	7230	12	
448174N	Case International IHC	Schlepper / Magnum	7240		
740825N	Case International IHC	Schlepper / Magnum	7240	12	
448174N	Case International IHC	Schlepper / Magnum	7250		
740825N	Case International IHC	Schlepper / Magnum	7250	12	
740824N	Case International IHC	Schlepper / MX	100	12	
740824N	Case International IHC	Schlepper / MX	110	12	
740824N	Case International IHC	Schlepper / MX	120	12	
740824N	Case International IHC	Schlepper / MX	135	12	
740824N	Case International IHC	Schlepper / MX	150	12	
740824N	Case International IHC	Schlepper / MX	170	12	
740824N	Case International IHC	Schlepper / MX	180	12	
740824N	Case International IHC	Schlepper / MX	200	12	
740824N	Case International IHC	Schlepper / MX	220	12	
740824N	Case International IHC	Schlepper / MX	240	12	
740824N	Case International IHC	Schlepper / MX	270	12	

Dasis Nr.	Hersteller	Modell	Typ	Spannung [V]	für OE-Nummer
740823N	Case International IHC	Schlepper / MXM	120		
740823N	Case International IHC	Schlepper / MXM	130		
740823N	Case International IHC	Schlepper / MXM	140		
740823N	Case International IHC	Schlepper / MXM	155		
740823N	Case International IHC	Schlepper / MXM	175		
740823N	Case International IHC	Schlepper / MXM	190		
740819N	Case International IHC	Schlepper / MXU	100	12	
740819N	Case International IHC	Schlepper / MXU	110	12	
740819N	Case International IHC	Schlepper / MXU	115	12	
740819N	Case International IHC	Schlepper / MXU	125	12	
740819N	Case International IHC	Schlepper / MXU	130	12	
740819N	Case International IHC	Schlepper / MXU	135	12	
448174N	Case International IHC	Schlepper / XL	743		
448174N	Case International IHC	Schlepper / XL	745		
448174N	Case International IHC	Schlepper / XL	844		
448174N	Case International IHC	Schlepper / XL	845		
448174N	Case International IHC	Schlepper / XL	856		
448174N	Case International IHC	Schlepper / XL	956		
448174N	Case International IHC	Schlepper / XL	1056		
448174N	Case International IHC	Schlepper / XL	1255		
448174N	Case International IHC	Schlepper / XL	1455		
448174N	Case International IHC	Schlepper / XL	3210		
448174N	Case International IHC	Schlepper / XL	3220		
448174N	Case International IHC	Schlepper / XL	3230		
448174N	Case International IHC	Schlepper / XL	4210		
448174N	Case International IHC	Schlepper / XL	4220		
448174N	Case International IHC	Schlepper / XL	4230		
448174N	Case International IHC	Schlepper / XL	4240		
448194N	Claas	Schlepper / Ares 500	540 RX/RZ		7700053496
448194N	Claas	Schlepper / Ares 500	546 RX/RZ		7700053496
448194N	Claas	Schlepper / Ares 500	556 RX/RZ		7700053496
448194N	Claas	Schlepper / Ares 500	566 RX/RZ		7700053496

Dasis Nr.	Hersteller	Modell	Typ	Spannung [V]	für OE-Nummer
448194N	Claas	Schlepper / Ares 600	610 RX/RZ		7700053496
448194N	Claas	Schlepper / Ares 600	616 RC		7700053496
448194N	Claas	Schlepper / Ares 600	616 RX/RZ		7700053496
448194N	Claas	Schlepper / Ares 600	620 RX/RZ		7700053496
448194N	Claas	Schlepper / Ares 600	626 RX/RZ		7700053496
448194N	Claas	Schlepper / Ares 600	630 RX/RZ		7700053496
448194N	Claas	Schlepper / Ares 600	640 RZ		7700053496
448194N	Claas	Schlepper / Ares 600	656 RC		7700053496
448194N	Claas	Schlepper / Ares 600	656 RZ		7700053496
448194N	Claas	Schlepper / Ares 600	696 RZ		7700053496
448194N	Claas	Schlepper / Ares 700	710 RZ		7700053496
448194N	Claas	Schlepper / Ares 700	715 RZ		7700053496
448194N	Claas	Schlepper / Ares 700	720 RZ		7700053496
448194N	Claas	Schlepper / Ares 800	816		7700053496
448194N	Claas	Schlepper / Ares 800	826		7700053496
448194N	Claas	Schlepper / Ares 800	836		7700053496
448194N	Claas	Schlepper / Atlas	926		7700053496
448194N	Claas	Schlepper / Atlas	936		7700053496
448194N	Claas	Schlepper / Atlas	946		7700053496
740150N	Deutz	Schlepper / AgroPrima DX	4.31		
740150N	Deutz	Schlepper / AgroPrima DX	4.51		
740150N	Deutz	Schlepper / AgroPrima DX	4.56		
740150N	Deutz	Schlepper / AgroPrima DX	6.06		
740150N	Deutz	Schlepper / AgroPrima DX	6.16		
740150N	Deutz	Schlepper / AgroStar	4.61		
740150N	Deutz	Schlepper / AgroStar	4.71		
740150N	Deutz	Schlepper / AgroStar	6.11		
740150N	Deutz	Schlepper / AgroStar	6.21		
740150N	Deutz	Schlepper / AgroStar	6.31		
740150N	Deutz	Schlepper / AgroStar	6.61		
740150N	Deutz	Schlepper / AgroStar	8360		
740150N	Deutz	Schlepper / AgroStar	8425		

Dasis Nr.	Hersteller	Modell	Typ	Spannung [V]	für OE-Nummer
741961N	Deutz	Schlepper / Agrottron mk3	80		1025350
741959N	Deutz	Schlepper / Agrottron mk3	80		1025370
741961N	Deutz	Schlepper / Agrottron mk3	85		1025350
741959N	Deutz	Schlepper / Agrottron mk3	85		1025370
741961N	Deutz	Schlepper / Agrottron mk3	90		1025350
741959N	Deutz	Schlepper / Agrottron mk3	90		1025370
741961N	Deutz	Schlepper / Agrottron mk3	90P		1025350
741959N	Deutz	Schlepper / Agrottron mk3	90P		1025370
741961N	Deutz	Schlepper / Agrottron mk3	100		1025350
741959N	Deutz	Schlepper / Agrottron mk3	100		1025370
741961N	Deutz	Schlepper / Agrottron mk3	100P		1025350
741959N	Deutz	Schlepper / Agrottron mk3	100P		1025370
741961N	Deutz	Schlepper / Agrottron mk3	105		1025350
741959N	Deutz	Schlepper / Agrottron mk3	105		1025370
741961N	Deutz	Schlepper / Agrottron mk3	106		1025350
741959N	Deutz	Schlepper / Agrottron mk3	106		1025370
741961N	Deutz	Schlepper / Agrottron mk3	110		1025350
741959N	Deutz	Schlepper / Agrottron mk3	110		1025370
741961N	Deutz	Schlepper / Agrottron mk3	110P		1025350
741959N	Deutz	Schlepper / Agrottron mk3	110P		1025370
741961N	Deutz	Schlepper / Agrottron mk3	115		1025350
741959N	Deutz	Schlepper / Agrottron mk3	115		1025370
741961N	Deutz	Schlepper / Agrottron mk3	120		1025350
741959N	Deutz	Schlepper / Agrottron mk3	120		1025370
741961N	Deutz	Schlepper / Agrottron mk3	120P		1025350
741959N	Deutz	Schlepper / Agrottron mk3	120P		1025370
741961N	Deutz	Schlepper / Agrottron mk3	135		1025350
741959N	Deutz	Schlepper / Agrottron mk3	135		1025370
741961N	Deutz	Schlepper / Agrottron mk3	150		1025350
741959N	Deutz	Schlepper / Agrottron mk3	150		1025370
741961N	Deutz	Schlepper / Agrottron mk3	160		1025350
741959N	Deutz	Schlepper / Agrottron mk3	160		1025370



Dasis Nr.	Hersteller	Modell	Typ	Spannung [V]	für OE-Nummer
741961N	Deutz	Schlepper / Agrottron mk3	165		1025350
741959N	Deutz	Schlepper / Agrottron mk3	165		1025370
741961N	Deutz	Schlepper / Agrottron mk3	175		1025350
741959N	Deutz	Schlepper / Agrottron mk3	175		1025370
741961N	Deutz	Schlepper / Agrottron mk3	200		1025350
741959N	Deutz	Schlepper / Agrottron mk3	200		1025370
741961N	Deutz	Schlepper / Agrottron mk3	230		1025350
741959N	Deutz	Schlepper / Agrottron mk3	230		1025370
741961N	Deutz	Schlepper / Agrottron mk3	260		1025350
741959N	Deutz	Schlepper / Agrottron mk3	260		1025370
741961N	Deutz	Schlepper / Agrottron TTV	1130		1025350
741959N	Deutz	Schlepper / Agrottron TTV	1130		1025370
741961N	Deutz	Schlepper / Agrottron TTV	1140		1025350
741959N	Deutz	Schlepper / Agrottron TTV	1140		1025370
741961N	Deutz	Schlepper / Agrottron TTV	1160		1025350
741959N	Deutz	Schlepper / Agrottron TTV	1160		1025370
740150N	Deutz	Schlepper / AgroXtra	3.57		
740150N	Deutz	Schlepper / AgroXtra	4.07		
740150N	Deutz	Schlepper / AgroXtra	4.17		
740150N	Deutz	Schlepper / AgroXtra	4.47		
740150N	Deutz	Schlepper / AgroXtra	4.57		
740150N	Deutz	Schlepper / AgroXtra	6.07		
740150N	Deutz	Schlepper / AgroXtra	6.17		
740150N	Deutz	Schlepper / DX3	3.10		
740150N	Deutz	Schlepper / DX3	3.30		
740150N	Deutz	Schlepper / DX3	3.50		
740150N	Deutz	Schlepper / DX3	3.60		
740150N	Deutz	Schlepper / DX3	3.65		
740150N	Deutz	Schlepper / DX3	3.70		
740150N	Deutz	Schlepper / DX3	3.80		
740150N	Deutz	Schlepper / DX3	3.90		
740150N	Deutz	Schlepper / DX4	4.10		

Dasis Nr.	Hersteller	Modell	Typ	Spannung [V]	für OE-Nummer
740150N	Deutz	Schlepper / DX4	4.30		
740150N	Deutz	Schlepper / DX4	4.50		
740150N	Deutz	Schlepper / DX4	4.70		
740150N	Fendt	Schlepper / Farmer 200	206		
740150N	Fendt	Schlepper / Farmer 200	206V		
740150N	Fendt	Schlepper / Farmer 200	206VA		
740150N	Fendt	Schlepper / Farmer 200	207		
740150N	Fendt	Schlepper / Farmer 200	207V		
740150N	Fendt	Schlepper / Farmer 200	207VA		
740150N	Fendt	Schlepper / Farmer 200	208		
740150N	Fendt	Schlepper / Farmer 200	208PA		
740150N	Fendt	Schlepper / Farmer 200	208VA		
740150N	Fendt	Schlepper / Farmer 200	209		
740150N	Fendt	Schlepper / Farmer 200	209PA		
740150N	Fendt	Schlepper / Farmer 200	209VA		
448195N	Fendt	Schlepper / Farmer 200	240		G275505900020
741953N	Fendt	Schlepper / Farmer 200	250S		F205550050160
448195N	Fendt	Schlepper / Farmer 200	250S		G275505900020
741953N	Fendt	Schlepper / Farmer 200	250V		F205550050160
448195N	Fendt	Schlepper / Farmer 200	250V		G275505900020
448195N	Fendt	Schlepper / Farmer 200	260P		G275505900020
741953N	Fendt	Schlepper / Farmer 200	260S		F205550050160
448195N	Fendt	Schlepper / Farmer 200	260S		G275505900020
741953N	Fendt	Schlepper / Farmer 200	260V		F205550050160
448195N	Fendt	Schlepper / Farmer 200	260V		G275505900020
741953N	Fendt	Schlepper / Farmer 200	270P		F205550050160
448195N	Fendt	Schlepper / Farmer 200	270P		G275505900020
741953N	Fendt	Schlepper / Farmer 200	270V		F205550050160
448195N	Fendt	Schlepper / Farmer 200	270V		G275505900020
741953N	Fendt	Schlepper / Farmer 200	275S		F205550050160
448195N	Fendt	Schlepper / Farmer 200	275S		G275505900020
741953N	Fendt	Schlepper / Farmer 200	275V		F205550050160

Dasis Nr.	Hersteller	Modell	Typ	Spannung [V]	für OE-Nummer
448195N	Fendt	Schlepper / Farmer 200	275V		G275505900020
741953N	Fendt	Schlepper / Farmer 200	280P		F205550050160
448195N	Fendt	Schlepper / Farmer 200	280P		G275505900020
741953N	Fendt	Schlepper / Farmer 200	280S		F205550050160
741953N	Fendt	Schlepper / Farmer 200	280V		F205550050160
448195N	Fendt	Schlepper / Farmer 300	304		G275505900020
448195N	Fendt	Schlepper / Farmer 300	304LS		G275505900020
448195N	Fendt	Schlepper / Farmer 300	304LSA		G275505900020
448195N	Fendt	Schlepper / Farmer 300	305		G275505900020
448195N	Fendt	Schlepper / Farmer 300	305LS		G275505900020
448195N	Fendt	Schlepper / Farmer 300	305LSA		G275505900020
448195N	Fendt	Schlepper / Farmer 300	306		G275505900020
448195N	Fendt	Schlepper / Farmer 300	306LS		G275505900020
448195N	Fendt	Schlepper / Farmer 300	306LSA		G275505900020
448195N	Fendt	Schlepper / Farmer 300	307		G275505900020
448195N	Fendt	Schlepper / Farmer 300	307LS		G275505900020
448195N	Fendt	Schlepper / Farmer 300	307LSA		G275505900020
448195N	Fendt	Schlepper / Farmer 300	308		G275505900020
448195N	Fendt	Schlepper / Farmer 300	308LS		G275505900020
448195N	Fendt	Schlepper / Farmer 300	308LSA		G275505900020
448195N	Fendt	Schlepper / Farmer 300	309		G275505900020
448195N	Fendt	Schlepper / Farmer 300	309LS		G275505900020
448195N	Fendt	Schlepper / Farmer 300	309LSA		G275505900020
448172N	Fendt	Schlepper / Favorit 500	509		
448172N	Fendt	Schlepper / Favorit 500	510		
448172N	Fendt	Schlepper / Favorit 500	511		
448172N	Fendt	Schlepper / Favorit 500	512		
448172N	Fendt	Schlepper / Favorit 500	514		
448172N	Fendt	Schlepper / Favorit 500	515		
448195N	Fendt	Schlepper / Favorit 600	600		G275505900020
448195N	Fendt	Schlepper / Favorit 600	610		G275505900020
448195N	Fendt	Schlepper / Favorit 600	611		G275505900020

Dasis Nr.	Hersteller	Modell	Typ	Spannung [V]	für OE-Nummer
448195N	Fendt	Schlepper / Favorit 600	612		G275505900020
448195N	Fendt	Schlepper / Favorit 600	614		G275505900020
448195N	Fendt	Schlepper / Favorit 600	615		G275505900020
448172N	Fendt	Schlepper / Favorit 700	711		
448172N	Fendt	Schlepper / Favorit 700	712		
448172N	Fendt	Schlepper / Favorit 700	714		
448172N	Fendt	Schlepper / Favorit 700	716		
448172N	Fendt	Schlepper / Favorit 800	815		
740140N	Fendt	Schlepper / Favorit 800	816		
448172N	Fendt	Schlepper / Favorit 800	816		
448172N	Fendt	Schlepper / Favorit 800	817		
740140N	Fendt	Schlepper / Favorit 800	818		
448172N	Fendt	Schlepper / Favorit 800	818		
448172N	Fendt	Schlepper / Favorit 800	820		
448172N	Fendt	Schlepper / Favorit 800	822		
740140N	Fendt	Schlepper / Favorit 800	822		
448172N	Fendt	Schlepper / Favorit 800	824		
740140N	Fendt	Schlepper / Favorit 800	824		
448172N	Fendt	Schlepper / Favorit 900	916		
448172N	Fendt	Schlepper / Favorit 900	920		
448172N	Fendt	Schlepper / Favorit 900	924		
448172N	Fendt	Schlepper / Favorit 900	926		
448172N	Fendt	Schlepper / GT300	370		
448172N	Fendt	Schlepper / GT300	380		
448195N	Fendt	Schlepper / GT300	390		G275505900020
448195N	Fendt	Schlepper / GT300	395		G275505900020
448042N	Fendt	Schlepper / Vario	309		
448168N	Fendt	Schlepper / Vario	309		F339552070020
448042N	Fendt	Schlepper / Vario	310		
448168N	Fendt	Schlepper / Vario	310		F339552070020
448042N	Fendt	Schlepper / Vario	311		
448042N	Fendt	Schlepper / Vario	312		

Dasis Nr.	Hersteller	Modell	Typ	Spannung [V]	für OE-Nummer
448168N	Fendt	Schlepper / Vario	312		F339552070020
448042N	Fendt	Schlepper / Vario	313		
448168N	Fendt	Schlepper / Vario	313		F339552070020
448042N	Fendt	Schlepper / Vario	411		
448168N	Fendt	Schlepper / Vario	411		F339552070020
448042N	Fendt	Schlepper / Vario	412		
448168N	Fendt	Schlepper / Vario	412		F339552070020
448042N	Fendt	Schlepper / Vario	413		
448168N	Fendt	Schlepper / Vario	413		F339552070020
448042N	Fendt	Schlepper / Vario	414		
448168N	Fendt	Schlepper / Vario	414		F339552070020
448042N	Fendt	Schlepper / Vario	415		
448168N	Fendt	Schlepper / Vario	415		F339552070020
740185N	Fendt	Schlepper / Vario	512		
740185N	Fendt	Schlepper / Vario	513		
740185N	Fendt	Schlepper / Vario	514		
740185N	Fendt	Schlepper / Vario	516		
448168N	Fendt	Schlepper / Vario	712		F339552070020
448042N	Fendt	Schlepper / Vario	714		
448168N	Fendt	Schlepper / Vario	714		F339552070020
448042N	Fendt	Schlepper / Vario	716		
448168N	Fendt	Schlepper / Vario	716		F339552070020
448042N	Fendt	Schlepper / Vario	718		
448168N	Fendt	Schlepper / Vario	718		F339552070020
448042N	Fendt	Schlepper / Vario	815		
448042N	Fendt	Schlepper / Vario	817		
448042N	Fendt	Schlepper / Vario	818		
448168N	Fendt	Schlepper / Vario	818		F339552070020
448042N	Fendt	Schlepper / Vario	820		
740140N	Fendt	Schlepper / Vario	916		
448042N	Fendt	Schlepper / Vario	916		
740140N	Fendt	Schlepper / Vario	918A		

Dasis Nr.	Hersteller	Modell	Typ	Spannung [V]	für OE-Nummer
740140N	Fendt	Schlepper / Vario	920		
740140N	Fendt	Schlepper / Vario	924		
740140N	Fendt	Schlepper / Vario	926		
448042N	Fendt	Schlepper / Vario	926		
740140N	Fendt	Schlepper / Vario	930		
448172N	Fendt	Schlepper / Xylon	520		
448172N	Fendt	Schlepper / Xylon	522		
448172N	Fendt	Schlepper / Xylon	524		
740823N	Fiat / Hitachi	Schlepper / M	100		
740823N	Fiat / Hitachi	Schlepper / M	115		
740823N	Fiat / Hitachi	Schlepper / M	135		
740823N	Fiat / Hitachi	Schlepper / M	160		
740823N	Fiat / Hitachi	Schlepper / M	180		
448175N	Fiat / Hitachi	Schlepper Wein Obst / M	100		
448175N	Fiat / Hitachi	Schlepper Wein Obst / M	115		
448175N	Fiat / Hitachi	Schlepper Wein Obst / M	135		
448175N	Fiat / Hitachi	Schlepper Wein Obst / M	160		
740829N	JCB	Bagger 360 ° / 800	802		
740818N	JCB	Baggerlader	RTFL	12	
741955N	JCB	Schlepper / Fastrac 2000	2155		333G6583
741955N	JCB	Schlepper / Fastrac 2000	2170		333G6583
741957N	JCB	Schlepper / Fastrac 3000	3200-65	12	
741957N	JCB	Schlepper / Fastrac 3000	3200-80	12	
741957N	JCB	Schlepper / Fastrac 3000	3200 XTRA	12	
741957N	JCB	Schlepper / Fastrac 3000	3230-65	12	
741957N	JCB	Schlepper / Fastrac 3000	3230-80	12	
741957N	JCB	Schlepper / Fastrac 3000	3230 XTRA	12	
741956N	JCB	Schlepper / Fastrac 8000	8250		
740821N	JCB	Teleskopplader / 500 Serie	520HL		
740821N	JCB	Teleskopplader / 500 Serie	520M		
740821N	JCB	Teleskopplader / 500 Serie	520S		
740821N	JCB	Teleskopplader / 500 Serie	525		

Dasis Nr.	Hersteller	Modell	Typ	Spannung [V]	für OE-Nummer
740821N	JCB	Teleskoplader / 500 Serie	525B		
740829N	JCB	Teleskoplader / SXL	530		
740829N	JCB	Teleskoplader / SXL	540		
448171N	John Deere	Feldhäcksler / 5030-5730	5200		
740826N	John Deere	Mähdrescher / 900-1188	1155		
740826N	John Deere	Mähdrescher / 900-1188	1157		
740826N	John Deere	Mähdrescher / 900-1188	1158		
740826N	John Deere	Mähdrescher / 900-1188	1166		
740826N	John Deere	Mähdrescher / 900-1188	1169		
740826N	John Deere	Mähdrescher / 900-1188	1169H		
740826N	John Deere	Mähdrescher / 900-1188	1169H4		
740826N	John Deere	Mähdrescher / 900-1188	1170		
740826N	John Deere	Mähdrescher / 900-1188	1174		
740826N	John Deere	Mähdrescher / 900-1188	1175		
740826N	John Deere	Mähdrescher / 900-1188	1177		
740826N	John Deere	Mähdrescher / 900-1188	1177H4		
740826N	John Deere	Mähdrescher / 900-1188	1188		
740826N	John Deere	Mähdrescher / 900-1188	1188H4		
740826N	John Deere	Schlepper / 1000-1950	1350		
740826N	John Deere	Schlepper / 1000-1950	1550		
740826N	John Deere	Schlepper / 1000-1950	1750		
740826N	John Deere	Schlepper / 1000-1950	1850		
740826N	John Deere	Schlepper / 1000-1950	1950		
740826N	John Deere	Schlepper / 2000-2955	2250		
740826N	John Deere	Schlepper / 3000-3650	3150		
740826N	John Deere	Schlepper / 3000-3650	3350		
740826N	John Deere	Schlepper / 3000-3650	3650		
740826N	John Deere	Schlepper / 4000-4955	4050		
740826N	John Deere	Schlepper / 4000-4955	4250		
740826N	John Deere	Schlepper / 4000-4955	4350		
740826N	John Deere	Schlepper / 4000-4955	4450		
740826N	John Deere	Schlepper / 4000-4955	4650		

Dasis Nr.	Hersteller	Modell	Typ	Spannung [V]	für OE-Nummer
740826N	John Deere	Schlepper / 4000-4955	4850		
448171N	John Deere	Schlepper / 5000-5820	5200		
448171N	John Deere	Schlepper / 5000-5820	5220		
448171N	John Deere	Schlepper / 5000-5820	5300		
448171N	John Deere	Schlepper / 5000-5820	5420		
448171N	John Deere	Schlepper / 5000-5820	5500		
448171N	John Deere	Schlepper / 5000-5820	5520		
448171N	John Deere	Schlepper / 6000-6930	6010		
448171N	John Deere	Schlepper / 6000-6930	6100		
448171N	John Deere	Schlepper / 6000-6930	6110		
448171N	John Deere	Schlepper / 6000-6930	6120		
448171N	John Deere	Schlepper / 6000-6930	6200		
448171N	John Deere	Schlepper / 6000-6930	6205		
448171N	John Deere	Schlepper / 6000-6930	6210		
448171N	John Deere	Schlepper / 6000-6930	6220		
448171N	John Deere	Schlepper / 6000-6930	6300		
448171N	John Deere	Schlepper / 6000-6930	6310		
448171N	John Deere	Schlepper / 6000-6930	6320		
448171N	John Deere	Schlepper / 6000-6930	6400		
448171N	John Deere	Schlepper / 6000-6930	6410		
448171N	John Deere	Schlepper / 6000-6930	6420		
448171N	John Deere	Schlepper / 6000-6930	6505		
448171N	John Deere	Schlepper / 6000-6930	6506		
448171N	John Deere	Schlepper / 6000-6930	6510		
448171N	John Deere	Schlepper / 6000-6930	6520		
448171N	John Deere	Schlepper / 6000-6930	6600		
448171N	John Deere	Schlepper / 6000-6930	6610		
448171N	John Deere	Schlepper / 6000-6930	6620		
448171N	John Deere	Schlepper / 6000-6930	6800		
448171N	John Deere	Schlepper / 6000-6930	6810		
448171N	John Deere	Schlepper / 6000-6930	6820		
448171N	John Deere	Schlepper / 6000-6930	6900		



Dasis Nr.	Hersteller	Modell	Typ	Spannung [V]	für OE-Nummer
448171N	John Deere	Schlepper / 6000-6930	6910		
448171N	John Deere	Schlepper / 6000-6930	6920		
448171N	John Deere	Schlepper / 7000-7920	7200		
448171N	John Deere	Schlepper / 7000-7920	7220		
448171N	John Deere	Schlepper / 7000-7920	7320		
448171N	John Deere	Schlepper / 7000-7920	7400		
448171N	John Deere	Schlepper / 7000-7920	7420		
448171N	John Deere	Schlepper / 7000-7920	7520		
448171N	John Deere	Schlepper / 7000-7920	7600		
448171N	John Deere	Schlepper / 7000-7920	7610		
448171N	John Deere	Schlepper / 7000-7920	7700		
448171N	John Deere	Schlepper / 7000-7920	7710		
448171N	John Deere	Schlepper / 7000-7920	7800		
448171N	John Deere	Schlepper / 7000-7920	7810		
741952N	Kobelco	Blade Runner	ED150	24	AN5150010700 YN20M00107S011 YN20M00107S111
741952N	Kobelco	Blade Runner	ED160	24	AN5150010700 YN20M00107S011 YN20M00107S111
741952N	Kobelco	Blade Runner	ED195-8	24	AN5150010700 YN20M00107S011 YN20M00107S111
741952N	Kobelco	Kettenbagger	80CS	24	AN5150010700 YN20M00107S011 YN20M00107S111
741952N	Kobelco	Kettenbagger	140SR	24	AN5150010700 YN20M00107S011 YN20M00107S111
741952N	Kobelco	Kettenbagger / Sk	80CS-2	24	AN5150010700 YN20M00107S011 YN20M00107S111
741952N	Kobelco	Kettenbagger / Sk	100L	24	AN5150010700 YN20M00107S011 YN20M00107S111
741952N	Kobelco	Kettenbagger / Sk	140SRLC	24	AN5150010700 YN20M00107S011 YN20M00107S111
741952N	Kobelco	Kettenbagger / Sk	200-6E	24	AN5150010700 YN20M00107S011 YN20M00107S111
741952N	Kobelco	Kettenbagger / Sk	210-8	24	AN5150010700 YN20M00107S011 YN20M00107S111
741952N	Kobelco	Kettenbagger / Sk	210LC-8	24	AN5150010700 YN20M00107S011 YN20M00107S111
741952N	Kobelco	Kettenbagger / Sk	215SRLC	24	AN5150010700 YN20M00107S011 YN20M00107S111

Dasis Nr.	Hersteller	Modell	Typ	Spannung [V]	für OE-Nummer
741952N	Kobelco	Kettenbagger / Sk	235SRLC-2	24	AN5150010700 YN20M00107S011 YN20M00107S111
741952N	Kobelco	Kettenbagger / Sk	295-8	24	AN5150010700 YN20M00107S011 YN20M00107S111
741952N	Kobelco	Kettenbagger / Sk	350-8	24	AN5150010700 YN20M00107S011 YN20M00107S111
741952N	Kobelco	Kettenbagger / Sk	850	24	AN5150010700 YN20M00107S011 YN20M00107S111
740818N	Manitou	Teleskoplader / MLT/MLA	523S1	12	
740818N	Manitou	Teleskoplader / MLT/MLA	523S2-	12	
740818N	Manitou	Teleskoplader / MLT/MLA	523TS1	12	
740818N	Manitou	Teleskoplader / MLT/MLA	523TS2	12	
740818N	Manitou	Teleskoplader / MLT/MLA	524S1	12	
740818N	Manitou	Teleskoplader / MLT/MLA	524TS1	12	
740818N	Manitou	Teleskoplader / MLT/MLA	526A	12	
740818N	Manitou	Teleskoplader / MLT/MLA	526S1	12	
740818N	Manitou	Teleskoplader / MLT/MLA	526S2	12	
740818N	Manitou	Teleskoplader / MLT/MLA	526TA	12	
740818N	Manitou	Teleskoplader / MLT/MLA	526TACompact	12	
740818N	Manitou	Teleskoplader / MLT/MLA	526TS1	12	
740818N	Manitou	Teleskoplader / MLT/MLA	526TS2	12	
740818N	Manitou	Teleskoplader / MLT/MLA	527S1	12	
740818N	Manitou	Teleskoplader / MLT/MLA	527TS1	12	
740818N	Manitou	Teleskoplader / MLT/MLA	626S2	12	
740818N	Manitou	Teleskoplader / MLT/MLA	626S3	12	
740818N	Manitou	Teleskoplader / MLT/MLA	626TS2	12	
740818N	Manitou	Teleskoplader / MLT/MLA	626TS3	12	
740818N	Manitou	Teleskoplader / MLT/MLA	627S1	12	
740818N	Manitou	Teleskoplader / MLT/MLA	628-120S3-E2PSLS	12	
740818N	Manitou	Teleskoplader / MLT/MLA	628S1	12	
740818N	Manitou	Teleskoplader / MLT/MLA	628TS1	12	
740818N	Manitou	Teleskoplader / MLT/MLA	628TS2PS	12	
740818N	Manitou	Teleskoplader / MLT/MLA	628TS2PSLS	12	
740818N	Manitou	Teleskoplader / MLT/MLA	628TS3-E2PS	12	

Dasis Nr.	Hersteller	Modell	Typ	Spannung [V]	für OE-Nummer
740818N	Manitou	Teleskoplader / MLT/MLA	629-120ALS	12	
740818N	Manitou	Teleskoplader / MLT/MLA	629A	12	
740818N	Manitou	Teleskoplader / MLT/MLA	629S1	12	
740818N	Manitou	Teleskoplader / MLT/MLA	629TA	12	
740818N	Manitou	Teleskoplader / MLT/MLA	629TS1	12	
740818N	Manitou	Teleskoplader / MLT/MLA	630-120B-E2LS	12	
740818N	Manitou	Teleskoplader / MLT/MLA	630S3	12	
740818N	Manitou	Teleskoplader / MLT/MLA	630TB-E2	12	
740818N	Manitou	Teleskoplader / MLT/MLA	630TS3	12	
740818N	Manitou	Teleskoplader / MLT/MLA	632S1	12	
740818N	Manitou	Teleskoplader / MLT/MLA	632TS1	12	
740818N	Manitou	Teleskoplader / MLT/MLA	633-120APSLs	12	
740818N	Manitou	Teleskoplader / MLT/MLA	633-120S1LS	12	
740818N	Manitou	Teleskoplader / MLT/MLA	633-120S1PSLS	12	
740818N	Manitou	Teleskoplader / MLT/MLA	633TALS	12	
740818N	Manitou	Teleskoplader / MLT/MLA	633TS1LS	12	
740818N	Manitou	Teleskoplader / MLT/MLA	633TS1PS	12	
740818N	Manitou	Teleskoplader / MLT/MLA	634-120B-E2LS	12	
740818N	Manitou	Teleskoplader / MLT/MLA	634-120B-E2PSLS	12	
740818N	Manitou	Teleskoplader / MLT/MLA	634TB-E2LS	12	
740818N	Manitou	Teleskoplader / MLT/MLA	725S2	12	
740818N	Manitou	Teleskoplader / MLT/MLA	725S3	12	
740818N	Manitou	Teleskoplader / MLT/MLA	725TS2	12	
740818N	Manitou	Teleskoplader / MLT/MLA	725TS3	12	
740818N	Manitou	Teleskoplader / MLT/MLA	728S1	12	
740818N	Manitou	Teleskoplader / MLT/MLA	728TS1	12	
740818N	Manitou	Teleskoplader / MLT/MLA	730-120ALS	12	
740818N	Manitou	Teleskoplader / MLT/MLA	730-120APSLs	12	
740818N	Manitou	Teleskoplader / MLT/MLA	730-120S1LS	12	
740818N	Manitou	Teleskoplader / MLT/MLA	730-120S1PSLS	12	
740818N	Manitou	Teleskoplader / MLT/MLA	730A	12	
740818N	Manitou	Teleskoplader / MLT/MLA	730S1	12	

Dasis Nr.	Hersteller	Modell	Typ	Spannung [V]	für OE-Nummer
740818N	Manitou	Teleskoplader / MLT/MLA	730TA	12	
740818N	Manitou	Teleskoplader / MLT/MLA	730TALS	12	
740818N	Manitou	Teleskoplader / MLT/MLA	730TS1	12	
740818N	Manitou	Teleskoplader / MLT/MLA	730TS1LS	12	
740818N	Manitou	Teleskoplader / MLT/MLA	731TB-E2	12	
740818N	Manitou	Teleskoplader / MLT/MLA	731TB-E2LS	12	
740818N	Manitou	Teleskoplader / MLT/MLA	740TS1HLS	12	
740818N	Manitou	Teleskoplader / MLT/MLA	741-120S2-E2LS	12	
740818N	Manitou	Teleskoplader / MLT/MLA	741-120S2-E2PSLS	12	
740818N	Manitou	Teleskoplader / MLT/MLA	742TS2-E2	12	
740818N	Manitou	Teleskoplader / MLT/MLA	742TS2-E2HLS	12	
741958N	Massey Ferguson	Schlepper / 3000	3315	12	1021211 549330500 72277622
741958N	Massey Ferguson	Schlepper / 3000	3325	12	1021211 549330500 72277622
741958N	Massey Ferguson	Schlepper / 3000	3330	12	1021211 549330500 72277622
741958N	Massey Ferguson	Schlepper / 3000	3340	12	1021211 549330500 72277622
741958N	Massey Ferguson	Schlepper / 3000	3350	12	1021211 549330500 72277622
741958N	Massey Ferguson	Schlepper / 3000	3355	12	1021211 549330500 72277622
448176N	MC Cormick	Schlepper / CX	50		
448176N	MC Cormick	Schlepper / CX	60		
448176N	MC Cormick	Schlepper / CX	70		
448176N	MC Cormick	Schlepper / CX	75		
448176N	MC Cormick	Schlepper / CX	80		
448176N	MC Cormick	Schlepper / CX	85		
448176N	MC Cormick	Schlepper / CX	90		
448176N	MC Cormick	Schlepper / CX	95		
448176N	MC Cormick	Schlepper / CX	100		
448176N	MC Cormick	Schlepper / CX	105		
448176N	MC Cormick	Schlepper / CX	110		
448176N	MC Cormick	Schlepper / MC	95		
448176N	MC Cormick	Schlepper / MC	105		
448176N	MC Cormick	Schlepper / MC	115		
448176N	MC Cormick	Schlepper / MC	120		

Dasis Nr.	Hersteller	Modell	Typ	Spannung [V]	für OE-Nummer
448176N	MC Cormick	Schlepper / MC	135		
448176N	MC Cormick	Schlepper / MTX	110		
448176N	MC Cormick	Schlepper / MTX	120		
448176N	MC Cormick	Schlepper / MTX	125		
448176N	MC Cormick	Schlepper / MTX	135		
448176N	MC Cormick	Schlepper / MTX	150		
448176N	MC Cormick	Schlepper / MTX	155		
448176N	MC Cormick	Schlepper / MTX	165		
448176N	MC Cormick	Schlepper / MTX	175		
448176N	MC Cormick	Schlepper / MTX	185		
448176N	MC Cormick	Schlepper / MTX	200		
448176N	MC Cormick	Schlepper / ZTX	145		
448176N	MC Cormick	Schlepper / ZTX	165		
448176N	MC Cormick	Schlepper / ZTX	185		
448176N	MC Cormick	Schlepper / ZTX	200		
448176N	MC Cormick	Schlepper / ZTX	215		
448176N	MC Cormick	Schlepper / ZTX	230		
448176N	MC Cormick	Schlepper / ZTX	260		
448176N	MC Cormick	Schlepper / ZTX	280		
740827N	NEW HOLLAND	Mähdrescher / LMA	430	12	
740827N	NEW HOLLAND	Mähdrescher / LMA	435	12	
740827N	NEW HOLLAND	Mähdrescher / LMA	445	12	
740822N	NEW HOLLAND	Schlepper / 3435-7635	3435	24	
740822N	NEW HOLLAND	Schlepper / 3435-7635	3935	24	
740822N	NEW HOLLAND	Schlepper / 3435-7635	4135	24	
740822N	NEW HOLLAND	Schlepper / 3435-7635	4635	24	
740822N	NEW HOLLAND	Schlepper / 3435-7635	4835	24	
740822N	NEW HOLLAND	Schlepper / 3435-7635	5635	24	
740822N	NEW HOLLAND	Schlepper / 3435-7635	6635	24	
740822N	NEW HOLLAND	Schlepper / 3435-7635	7635	24	
740823N	NEW HOLLAND	Schlepper / 4140-8340	5640		
740823N	NEW HOLLAND	Schlepper / 4140-8340	6640		

Dasis Nr.	Hersteller	Modell	Typ	Spannung [V]	für OE-Nummer
740823N	NEW HOLLAND	Schlepper / 4140-8340	7740		
740823N	NEW HOLLAND	Schlepper / 4140-8340	7840		
740823N	NEW HOLLAND	Schlepper / 4140-8340	8240		
740823N	NEW HOLLAND	Schlepper / 4140-8340	8340		
740823N	NEW HOLLAND	Schlepper / 8160-8560	8160		
740823N	NEW HOLLAND	Schlepper / 8160-8560	8260		
740823N	NEW HOLLAND	Schlepper / 8160-8560	8360		
740823N	NEW HOLLAND	Schlepper / 8160-8560	8560		
740822N	NEW HOLLAND	Schlepper / TL	70	24	
740822N	NEW HOLLAND	Schlepper / TL	80	24	
740822N	NEW HOLLAND	Schlepper / TL	90	24	
740822N	NEW HOLLAND	Schlepper / TL	100	24	
740823N	NEW HOLLAND	Schlepper / TS	80		
740823N	NEW HOLLAND	Schlepper / TS	90		
740823N	NEW HOLLAND	Schlepper / TS	100		
740823N	NEW HOLLAND	Schlepper / TS	110		
740823N	NEW HOLLAND	Schlepper / TS	115		
740817N	NEW HOLLAND	Teleskoplader / 4400	4430		
740827N	NEW HOLLAND	Teleskoplader / LMA	410	12	
740827N	NEW HOLLAND	Teleskoplader / LMA	415	12	
740827N	NEW HOLLAND	Teleskoplader / LMA	420	12	
740827N	NEW HOLLAND	Teleskoplader / LMA	425A	12	
448173N	Renault	Schlepper / Ares 300	317		
448173N	Renault	Schlepper / Ares 500	540		
448194N	Renault	Schlepper / Ares 500	540		7700053496
448173N	Renault	Schlepper / Ares 500	546		
448194N	Renault	Schlepper / Ares 500	546		7700053496
448194N	Renault	Schlepper / Ares 500	546 RX/RZ		7700053496
448173N	Renault	Schlepper / Ares 500	547		
448173N	Renault	Schlepper / Ares 500	550		
448194N	Renault	Schlepper / Ares 500	550		7700053496
448173N	Renault	Schlepper / Ares 500	556		

Dasis Nr.	Hersteller	Modell	Typ	Spannung [V]	für OE-Nummer
448194N	Renault	Schlepper / Ares 500	556		7700053496
448194N	Renault	Schlepper / Ares 500	556 RX/RZ		7700053496
448173N	Renault	Schlepper / Ares 500	557		
448173N	Renault	Schlepper / Ares 500	566		
448194N	Renault	Schlepper / Ares 500	566		7700053496
448194N	Renault	Schlepper / Ares 500	566 RX/RZ		7700053496
448173N	Renault	Schlepper / Ares 500	567		
448173N	Renault	Schlepper / Ares 500	577		
448173N	Renault	Schlepper / Ares 600	610		
448194N	Renault	Schlepper / Ares 600	610		7700053496
448173N	Renault	Schlepper / Ares 600	616		
448194N	Renault	Schlepper / Ares 600	616		7700053496
448194N	Renault	Schlepper / Ares 600	616 RX/RZ		7700053496
448173N	Renault	Schlepper / Ares 600	617		
448173N	Renault	Schlepper / Ares 600	620		
448194N	Renault	Schlepper / Ares 600	620		7700053496
448173N	Renault	Schlepper / Ares 600	626		
448194N	Renault	Schlepper / Ares 600	626		7700053496
448194N	Renault	Schlepper / Ares 600	626 RX/RZ		7700053496
448173N	Renault	Schlepper / Ares 600	630		
448194N	Renault	Schlepper / Ares 600	630		7700053496
448173N	Renault	Schlepper / Ares 600	636		
448173N	Renault	Schlepper / Ares 600	640		
448194N	Renault	Schlepper / Ares 600	640		7700053496
448194N	Renault	Schlepper / Ares 600	656 RZ		7700053496
448173N	Renault	Schlepper / Ares 600	657		
448173N	Renault	Schlepper / Ares 600	696		
448194N	Renault	Schlepper / Ares 600	696		7700053496
448194N	Renault	Schlepper / Ares 600	696 RZ		7700053496
448173N	Renault	Schlepper / Ares 600	697		
448173N	Renault	Schlepper / Ares 700	710		
448194N	Renault	Schlepper / Ares 700	710		7700053496

Dasis Nr.	Hersteller	Modell	Typ	Spannung [V]	für OE-Nummer
448173N	Renault	Schlepper / Ares 700	715		
448194N	Renault	Schlepper / Ares 700	715		7700053496
448173N	Renault	Schlepper / Ares 700	720		
448194N	Renault	Schlepper / Ares 700	720		7700053496
448173N	Renault	Schlepper / Ares 700	735		
448173N	Renault	Schlepper / Ares 800	815		
448194N	Renault	Schlepper / Ares 800	815		7700053496
448173N	Renault	Schlepper / Ares 800	816		
448194N	Renault	Schlepper / Ares 800	816		7700053496
448173N	Renault	Schlepper / Ares 800	825		
448194N	Renault	Schlepper / Ares 800	825		7700053496
448173N	Renault	Schlepper / Ares 800	826		
448173N	Renault	Schlepper / Ares 800	836		
448194N	Renault	Schlepper / Ares 800	836		7700053496
448194N	Renault	Schlepper / Ares 900	915 RZ		7700053496
448194N	Renault	Schlepper / Ares 900	925 RZ		7700053496
448194N	Renault	Schlepper / Ares 900	926 RZ		7700053496
448194N	Renault	Schlepper / Ares 900	935 RZ		7700053496
448194N	Renault	Schlepper / Ares 900	936 RZ		7700053496
448173N	Renault	Schlepper / Atlas	915		
448173N	Renault	Schlepper / Atlas	925		
448173N	Renault	Schlepper / Atlas	926		
448173N	Renault	Schlepper / Atlas	936		
448173N	Renault	Schlepper / Axion	810		
448173N	Renault	Schlepper / Axion	820		
448173N	Renault	Schlepper / Axion	830		
448173N	Renault	Schlepper / Axion	840		
448173N	Renault	Schlepper / Axion	850		
448173N	Renault	Schlepper / Celits	426		
448173N	Renault	Schlepper / Celits	436		
448173N	Renault	Schlepper / Celits	446		
448173N	Renault	Schlepper / Celits	456		



Dasis Nr.	Hersteller	Modell	Typ	Spannung [V]	für OE-Nummer
448168N	Valtra Valmet	Schlepper / T1	191		F339552070020
741954N	Volvo	Radlader	L20F	24	15073261 VOE15073261
741954N	Volvo	Radlader	L25F	24	15073261 VOE15073261
741954N	Volvo	Radlader	L28F	24	15073261 VOE15073261
741954N	Volvo	Radlader	L50F	24	15073261 VOE15073261
741954N	Volvo	Radlader	L60F	24	15073261 VOE15073261
741954N	Volvo	Radlader	L70F	24	15073261 VOE15073261
741954N	Volvo	Radlader	L80F	24	15073261 VOE15073261
741954N	Volvo	Radlader	L90F	24	15073261 VOE15073261
741954N	Volvo	Radlader	L110F	24	15073261 VOE15073261
741954N	Volvo	Radlader	L200F	24	15073261 VOE15073261
741954N	Volvo	Radlader	L350F	24	15073261 VOE15073261
741962N	Volvo	Schaufellader / BL	60B		
741962N	Volvo	Schaufellader / BL	61B		
741962N	Volvo	Schaufellader / BL	70B		
741962N	Volvo	Schaufellader / BL	71B		

Dasis Nr.	Hersteller	Modell	Typ	KW	Herstellereinschränkung	Kompressor-ID	Riemenscheiben-Ø [mm]	Rippenanzahl	Spannung [V]	Zylinderkopf-ID (Kompressor)	Einlass-Ø [mm]	Auslass-Ø [mm]
850625N	Agco	Feldspritze DT	225	0	Sanden	SD7H15	132	2	12	QC	16	16
850883N	Agco	Raupen Dozer / MT	T425	0	Sanden	SD510	140	2	12	QC	16,4	16,4
850626N	Agco	Raupen Dozer / MT	T425B	0	Sanden	SD7H15	120	10	24	VE	17,8	11,8
850883N	Agco	Raupen Dozer / MT	T425B	0	Sanden	SD510	140	2	12	QC	16,4	16,4
850626N	Agco	Raupen Dozer / MT	T434	0	Sanden	SD7H15	120	10	24	VE	17,8	11,8
850883N	Agco	Raupen Dozer / MT	T434	0	Sanden	SD510	140	2	12	QC	16,4	16,4
850883N	Agco	Raupen Dozer / MT	T444	0	Sanden	SD510	140	2	12	QC	16,4	16,4
850626N	Agco	Raupen Dozer / MT	T445	0	Sanden	SD7H15	120	10	24	VE	17,8	11,8
850883N	Agco	Raupen Dozer / MT	T445	0	Sanden	SD510	140	2	12	QC	16,4	16,4
850626N	Agco	Raupen Dozer / MT	T445B	0	Sanden	SD7H15	120	10	24	VE	17,8	11,8
850883N	Agco	Raupen Dozer / MT	T445B	0	Sanden	SD510	140	2	12	QC	16,4	16,4
850883N	Agco	Raupen Dozer / MT	T454	0	Sanden	SD510	140	2	12	QC	16,4	16,4
850626N	Agco	Raupen Dozer / MT	T455	0	Sanden	SD7H15	120	10	24	VE	17,8	11,8
850883N	Agco	Raupen Dozer / MT	T455	0	Sanden	SD510	140	2	12	QC	16,4	16,4
850626N	Agco	Raupen Dozer / MT	T455B	0	Sanden	SD7H15	120	10	24	VE	17,8	11,8
850883N	Agco	Raupen Dozer / MT	T455B	0	Sanden	SD510	140	2	12	QC	16,4	16,4
850626N	Agco	Raupen Dozer / MT	T465	0	Sanden	SD7H15	120	10	24	VE	17,8	11,8
850883N	Agco	Raupen Dozer / MT	T465	0	Sanden	SD510	140	2	12	QC	16,4	16,4
850626N	Agco	Raupen Dozer / MT	T465B	0	Sanden	SD7H15	120	10	24	VE	17,8	11,8
850883N	Agco	Raupen Dozer / MT	T465B	0	Sanden	SD510	140	2	12	QC	16,4	16,4
851763N	Agco	Raupen Dozer / MT	T525B	0	Sanden	SD7H15	112	4	12		16	16
850626N	Agco	Raupen Dozer / MT	T535	0	Sanden	SD7H15	120	10	24	VE	17,8	11,8

Dasis Nr.	Hersteller	Modell	Typ	KW	Herstellereinschränkung	Kompressor-ID	Riemenscheiben-Ø [mm]	Rippenanzahl	Spannung [V]	Zylinderkopf-ID (Kompressor)	Einlass-Ø [mm]	Auslass-Ø [mm]
850883N	Agco	Raupen Dozer / MT	T535	0	Sanden	SD510	140	2	12	QC	16,4	16,4
850626N	Agco	Raupen Dozer / MT	T545	0	Sanden	SD7H15	120	10	24	VE	17,8	11,8
850883N	Agco	Raupen Dozer / MT	T545	0	Sanden	SD510	140	2	12	QC	16,4	16,4
851763N	Agco	Raupen Dozer / MT	T545B	0	Sanden	SD7H15	112	4	12		16	16
850626N	Agco	Raupen Dozer / MT	T545B	0	Sanden	SD7H15	120	10	24	VE	17,8	11,8
851763N	Agco	Raupen Dozer / MT	T553B	0	Sanden	SD7H15	112	4	12		16	16
850626N	Agco	Raupen Dozer / MT	T553B	0	Sanden	SD7H15	120	10	24	VE	17,8	11,8
851763N	Agco	Raupen Dozer / MT	T555B	0	Sanden	SD7H15	112	4	12		16	16
850626N	Agco	Raupen Dozer / MT	T555B	0	Sanden	SD7H15	120	10	24	VE	17,8	11,8
850883N	Agco	Raupen Dozer / MT	T565	0	Sanden	SD510	140	2	12	QC	16,4	16,4
851763N	Agco	Raupen Dozer / MT	T565B	0	Sanden	SD7H15	112	4	12		16	16
850626N	Agco	Raupen Dozer / MT	T565B	0	Sanden	SD7H15	120	10	24	VE	17,8	11,8
851763N	Agco	Raupen Dozer / MT	T575B	0	Sanden	SD7H15	112	4	12		16	16
850626N	Agco	Raupen Dozer / MT	T635	0	Sanden	SD7H15	120	10	24	VE	17,8	11,8
850883N	Agco	Raupen Dozer / MT	T635	0	Sanden	SD510	140	2	12	QC	16,4	16,4
851763N	Agco	Raupen Dozer / MT	T635B	0	Sanden	SD7H15	112	4	12		16	16
850626N	Agco	Raupen Dozer / MT	T635B	0	Sanden	SD7H15	120	10	24	VE	17,8	11,8
850626N	Agco	Raupen Dozer / MT	T645	0	Sanden	SD7H15	120	10	24	VE	17,8	11,8
850883N	Agco	Raupen Dozer / MT	T645	0	Sanden	SD510	140	2	12	QC	16,4	16,4
851763N	Agco	Raupen Dozer / MT	T645B	0	Sanden	SD7H15	112	4	12		16	16
850626N	Agco	Raupen Dozer / MT	T645B	0	Sanden	SD7H15	120	10	24	VE	17,8	11,8

Dasis Nr.	Hersteller	Modell	Typ	KW	Herstellereinschränkung	Kompressor-ID	Riemenscheiben-Ø [mm]	Rippenanzahl	Spannung [V]	Zylinderkopf-ID (Kompressor)	Einlass-Ø [mm]	Auslass-Ø [mm]
850626N	Agco	Raupen Dozer / MT	T655	0	Sanden	SD7H15	120	10	24	VE	17,8	11,8
850883N	Agco	Raupen Dozer / MT	T655	0	Sanden	SD510	140	2	12	QC	16,4	16,4
851763N	Agco	Raupen Dozer / MT	T655B	0	Sanden	SD7H15	112	4	12		16	16
850626N	Agco	Raupen Dozer / MT	T655B	0	Sanden	SD7H15	120	10	24	VE	17,8	11,8
850626N	Agco	Raupen Dozer / MT	T665	0	Sanden	SD7H15	120	10	24	VE	17,8	11,8
850883N	Agco	Raupen Dozer / MT	T665	0	Sanden	SD510	140	2	12	QC	16,4	16,4
851729N	Agco	Raupen Dozer / MT	T700	0	Sanden	SD7H15	132	8	12	KCA	13	15
851729N	Agco	Raupen Dozer / MT	T800	0	Sanden	SD7H15	132	8	12	KCA	13	15
851105N	Agco	Selbstfahrende Farbspritze / Rogator 600-874	654	0	Sanden	SD508	132	2	12	B	16	13
851105N	Agco	Selbstfahrende Farbspritze / Rogator 600-874	664	0	Sanden	SD508	132	2	12	B	16	13
851702N	Agco	Selbstfahrende Farbspritze / Rogator 600-874	844	0		SD5H14	132	2	12			
851702N	Agco	Selbstfahrende Farbspritze / Rogator 600-874	854	0		SD5H14	132	2	12			
851702N	Agco	Selbstfahrende Farbspritze / Rogator 600-874	864	0		SD5H14	132	2	12			
851702N	Agco	Selbstfahrende Farbspritze / Rogator 600-874	874	0		SD5H14	132	2	12			
851756N	Agco	Selbstfahrende Farbspritze / Rogator 1000	1054	0	Sanden	SD7H15	133	8	12	JD	16	12
851756N	Agco	Selbstfahrende Farbspritze / Rogator 1000	1064	0	Sanden	SD7H15	133	8	12	JD	16	12
851756N	Agco	Selbstfahrende Farbspritze / Rogator 1000	1074	0	Sanden	SD7H15	133	8	12	JD	16	12

Dasis Nr.	Hersteller	Modell	Typ	KW	Herstellereinschränkung	Kompressor-ID	Riemenscheiben-Ø [mm]	Rippenanzahl	Spannung [V]	Zylinderkopf-ID (Kompressor)	Einlass-Ø [mm]	Auslass-Ø [mm]
851756N	Agco	Selbstfahrende Farbspritze / Rogator 1000	1254	0	Sanden	SD7H15	133	8	12	JD	16	12
851756N	Agco	Selbstfahrende Farbspritze / Rogator 1000	1264	0	Sanden	SD7H15	133	8	12	JD	16	12
851756N	Agco	Selbstfahrende Farbspritze / Rogator 1000	1274	0	Sanden	SD7H15	133	8	12	JD	16	12
851702N	Agco	Selbstfahrende Farbspritze / Terragator 1000	1603	0		SD5H14	132	2	12			
858485N	Agco	Selbstfahrende Farbspritze / Terragator 1000	1603T	0	Sanden	SD5H14	132	2	12	B		
858485N	Agco	Selbstfahrende Farbspritze / Terragator 1000	1664T	0	Sanden	SD5H14	132	2	12	B		
858485N	Agco	Selbstfahrende Farbspritze / Terragator 1000	1803	0	Sanden	SD5H14	132	2	12	B		
851756N	Agco	Selbstfahrende Farbspritze / Terragator 1000	1844	0	Sanden	SD7H15	133	8	12	JD	16	12
851698N	Agco	Selbstfahrende Farbspritze / Terragator 1000	1903	0	Sanden	SD7H15	132	2	12			
851756N	Agco	Selbstfahrende Farbspritze / Terragator 8000	8103	0	Sanden	SD7H15	133	8	12	JD	16	12
851756N	Agco	Selbstfahrende Farbspritze / Terragator 8000	8104	0	Sanden	SD7H15	133	8	12	JD	16	12
851756N	Agco	Selbstfahrende Farbspritze / Terragator 9000	9103	0	Sanden	SD7H15	133	8	12	JD	16	12
851756N	Agco	Selbstfahrende Farbspritze / Terragator 9000	9105	0	Sanden	SD7H15	133	8	12	JD	16	12
851705N	Bateman	Selbstfahrende Farbspritze	Verschiedene Modelle	0	Sanden	SD5H09	125	2	12			
851698N	Bateman	Selbstfahrende Farbspritze / RB	15	0	Sanden	SD7H15	132	2	12			

Dasis Nr.	Hersteller	Modell	Typ	KW	Herstellereinschränkung	Kompressor-ID	Riemenscheiben-Ø [mm]	Rippenanzahl	Spannung [V]	Zylinderkopf-ID (Kompressor)	Einlass-Ø [mm]	Auslass-Ø [mm]
851698N	Bateman	Selbstfahrende Farbspritze / RB	16	0	Sanden	SD7H15	132	2	12			
851698N	Bateman	Selbstfahrende Farbspritze / RB	25	0	Sanden	SD7H15	132	2	12			
851107N	Braud NH	Selbstfahrende Farbspritze / SB	33	0	Sanden	SD7H15	132	2	12		22	19
851107N	Braud NH	Selbstfahrende Farbspritze / SB	35	0	Sanden	SD7H15	132	2	12		22	19
851107N	Braud NH	Selbstfahrende Farbspritze / SB	36	0	Sanden	SD7H15	132	2	12		22	19
851107N	Braud NH	Selbstfahrende Farbspritze / SB	52	0	Sanden	SD7H15	132	2	12		22	19
851107N	Braud NH	Selbstfahrende Farbspritze / SB	53	0	Sanden	SD7H15	132	2	12		22	19
851107N	Braud NH	Selbstfahrende Farbspritze / SB	54	0	Sanden	SD7H15	132	2	12		22	19
851107N	Braud NH	Selbstfahrende Farbspritze / SB	55	0	Sanden	SD7H15	132	2	12		22	19
851107N	Braud NH	Selbstfahrende Farbspritze / SB	56	0	Sanden	SD7H15	132	2	12		22	19
851107N	Braud NH	Selbstfahrende Farbspritze / SB	58	0	Sanden	SD7H15	132	2	12		22	19
851107N	Braud NH	Selbstfahrende Farbspritze / SB	60	0	Sanden	SD7H15	132	2	12		22	19
851107N	Braud NH	Selbstfahrende Farbspritze / SB	62	0	Sanden	SD7H15	132	2	12		22	19
851107N	Braud NH	Selbstfahrende Farbspritze / SB	64	0	Sanden	SD7H15	132	2	12		22	19
851107N	Braud NH	Selbstfahrende Farbspritze / SB	65	0	Sanden	SD7H15	132	2	12		22	19
851107N	Braud NH	Selbstfahrende Farbspritze / TB	10	0	Sanden	SD7H15	132	2	12		22	19
851699N	Braud NH	Selbstfahrende Farbspritze / TB	10	0	Sanden	SD7H15HD	132	2	12	CB	14	14
851107N	Braud NH	Selbstfahrende Farbspritze / TB	15	0	Sanden	SD7H15	132	2	12		22	19
851699N	Braud NH	Selbstfahrende Farbspritze / TB	15	0	Sanden	SD7H15HD	132	2	12	CB	14	14
851107N	Braud NH	Selbstfahrende Farbspritze / VL	610	0	Sanden	SD7H15	132	2	12		22	19
851699N	Braud NH	Selbstfahrende Farbspritze / VL	610	0	Sanden	SD7H15HD	132	2	12	CB	14	14

Dasis Nr.	Hersteller	Modell	Typ	KW	Herstellereinschränkung	Kompressor-ID	Riemenscheiben-Ø [mm]	Rippenanzahl	Spannung [V]	Zylinderkopf-ID (Kompressor)	Einlass-Ø [mm]	Auslass-Ø [mm]
851107N	Braud NH	Selbstfahrende Farbspritze / VL	620	0	Sanden	SD7H15	132	2	12		22	19
851699N	Braud NH	Selbstfahrende Farbspritze / VL	620	0	Sanden	SD7H15HD	132	2	12	CB	14	14
851107N	Braud NH	Selbstfahrende Farbspritze / VL	630	0	Sanden	SD7H15	132	2	12		22	19
851699N	Braud NH	Selbstfahrende Farbspritze / VL	630	0	Sanden	SD7H15HD	132	2	12	CB	14	14
851107N	Braud NH	Selbstfahrende Farbspritze / VL	640	0	Sanden	SD7H15	132	2	12		22	19
851699N	Braud NH	Selbstfahrende Farbspritze / VL	640	0	Sanden	SD7H15HD	132	2	12	CB	14	14
851107N	Braud NH	Selbstfahrende Farbspritze / VL	660	0	Sanden	SD7H15	132	2	12		22	19
851699N	Braud NH	Selbstfahrende Farbspritze / VL	660	0	Sanden	SD7H15HD	132	2	12	CB	14	14
851107N	Braud NH	Selbstfahrende Farbspritze / VN	240	0	Sanden	SD7H15	132	2	12		22	19
851699N	Braud NH	Selbstfahrende Farbspritze / VN	240	0	Sanden	SD7H15HD	132	2	12	CB	14	14
851107N	Braud NH	Selbstfahrende Farbspritze / VN	260	0	Sanden	SD7H15	132	2	12		22	19
851699N	Braud NH	Selbstfahrende Farbspritze / VN	260	0	Sanden	SD7H15HD	132	2	12	CB	14	14
850352N	Case International IHC	Baggerlader	580	0	York	T209/210L					14,9	14,9
850870N	Case International IHC	Baggerlader	580K	0	Sanden	SD5H14	132	2	12	FG	16	13
850874N	Case International IHC	Baggerlader	580L	0	Sanden	SD7H15HD	152	2	12	MD	14,5	14,5
850352N	Case International IHC	Baggerlader	580Super	0	York	T209/210L					14,9	14,9
850422N	Case International IHC	Baggerlader	580SuperE	0	York	R209/210R	ohne Riemenscheibe	ohne Riemenscheibe			13,5	13,5
850352N	Case International IHC	Baggerlader	580SuperE	0	York	T209/210L					14,9	14,9

Dasis Nr.	Hersteller	Modell	Typ	KW	Herstellereinschränkung	Kompressor-ID	Riemenscheiben-Ø [mm]	Rippenanzahl	Spannung [V]	Zylinderkopf-ID (Kompressor)	Einlass-Ø [mm]	Auslass-Ø [mm]
851746N	Case International IHC	Baggerlader	580SuperK	0	Sanden	SD508	152	2	12	M	20,5	20,5
850422N	Case International IHC	Baggerlader	581Super	0	York	R209/210R	ohne Riemenscheibe	ohne Riemenscheibe			13,5	13,5
851746N	Case International IHC	Baggerlader	581SuperK	0	Sanden	SD508	152	2	12	M	20,5	20,5
850874N	Case International IHC	Baggerlader	590SuperL	0	Sanden	SD7H15HD	152	2	12	MD	14,5	14,5
850874N	Case International IHC	Baggerlader	590Turbo	0	Sanden	SD7H15HD	152	2	12	MD	14,5	14,5
850874N	Case International IHC	Baggerlader	591Turbo	0	Sanden	SD7H15HD	152	2	12	MD	14,5	14,5
850352N	Case International IHC	Baggerlader	680K	0	York	T209/210L					14,9	14,9
850874N	Case International IHC	Baggerlader	680L	0	Sanden	SD7H15HD	152	2	12	MD	14,5	14,5
851746N	Case International IHC	Baggerlader	680L	0	Sanden	SD508	152	2	12	M	20,5	20,5
850352N	Case International IHC	Baggerlader	680L	0	York	T209/210L					14,9	14,9
851746N	Case International IHC	Baggerlader	780	0	Sanden	SD508	152	2	12	M	20,5	20,5
850352N	Case International IHC	Baggerlader	780	0	York	T209/210L					14,9	14,9
852647N	Case International IHC	Feldhäcksler / CHX	320	0	Denso	10PA17C	115	4	12		16	15
851769N	Case International IHC	Feldhäcksler / CHX	320	0	Sanden	SD7H15	119	4	12			



Dasis Nr.	Hersteller	Modell	Typ	KW	Herstellereinschränkung	Kompressor-ID	Riemenscheiben-Ø [mm]	Rippenanzahl	Spannung [V]	Zylinderkopf-ID (Kompressor)	Einlass-Ø [mm]	Auslass-Ø [mm]
852647N	Case International IHC	Feldhäcksler / CHX	420	0	Denso	10PA17C	115	4	12		16	15
851769N	Case International IHC	Feldhäcksler / CHX	420	0	Sanden	SD7H15	119	4	12			
852647N	Case International IHC	Feldhäcksler / CHX	520	0	Denso	10PA17C	115	4	12		16	15
851769N	Case International IHC	Feldhäcksler / CHX	520	0	Sanden	SD7H15	119	4	12			
851769N	Case International IHC	Feldhäcksler / CHX	620	0	Sanden	SD7H15	119	4	12			
850875N	Case International IHC	Feldhäcksler / CHX	620	0	Sanden	SD7H15	132	2	12	KG		
852922N	Case International IHC	Kompaktlader	SR175	0	Sanden	SD5H11	152	6	12	FL		
852922N	Case International IHC	Kompaktlader	SV185	0	Sanden	SD5H11	152	6	12	FL		
850422N	Case International IHC	Mähdrescher / 14	1420	0	York	R209/210R	ohne Riemenscheibe	ohne Riemenscheibe			13,5	13,5
850422N	Case International IHC	Mähdrescher / 14	1440	0	York	R209/210R	ohne Riemenscheibe	ohne Riemenscheibe			13,5	13,5
850422N	Case International IHC	Mähdrescher / 14	1460	0	York	R209/210R	ohne Riemenscheibe	ohne Riemenscheibe			13,5	13,5
850422N	Case International IHC	Mähdrescher / 14	1470	0	York	R209/210R	ohne Riemenscheibe	ohne Riemenscheibe			13,5	13,5
850422N	Case International IHC	Mähdrescher / 14	1480	0	York	R209/210R	ohne Riemenscheibe	ohne Riemenscheibe			13,5	13,5
851746N	Case International IHC	Mähdrescher / 16	1620	0	Sanden	SD508	152	2	12	M	20,5	20,5

Dasis Nr.	Hersteller	Modell	Typ	KW	Herstellereinschränkung	Kompressor-ID	Riemenscheiben-Ø [mm]	Rippenanzahl	Spannung [V]	Zylinderkopf-ID (Kompressor)	Einlass-Ø [mm]	Auslass-Ø [mm]
850423N	Case International IHC	Mähdrescher / 16	1620	0	York	T209/210R					16	16
851746N	Case International IHC	Mähdrescher / 16	1620E	0	Sanden	SD508	152	2	12	M	20,5	20,5
850423N	Case International IHC	Mähdrescher / 16	1620E	0	York	T209/210R					16	16
851746N	Case International IHC	Mähdrescher / 16	1640	0	Sanden	SD508	152	2	12	M	20,5	20,5
850423N	Case International IHC	Mähdrescher / 16	1640	0	York	T209/210R					16	16
851746N	Case International IHC	Mähdrescher / 16	1644	0	Sanden	SD508	152	2	12	M	20,5	20,5
851746N	Case International IHC	Mähdrescher / 16	1660	0	Sanden	SD508	152	2	12	M	20,5	20,5
851746N	Case International IHC	Mähdrescher / 16	1660E	0	Sanden	SD508	152	2	12	M	20,5	20,5
850423N	Case International IHC	Mähdrescher / 16	1660E	0	York	T209/210R					16	16
851746N	Case International IHC	Mähdrescher / 16	1666	0	Sanden	SD508	152	2	12	M	20,5	20,5
850423N	Case International IHC	Mähdrescher / 16	1666	0	York	T209/210R					16	16
851746N	Case International IHC	Mähdrescher / 16	1670	0	Sanden	SD508	152	2	12	M	20,5	20,5
850423N	Case International IHC	Mähdrescher / 16	1670	0	York	T209/210R					16	16
851746N	Case International IHC	Mähdrescher / 16	1680	0	Sanden	SD508	152	2	12	M	20,5	20,5

Dasis Nr.	Hersteller	Modell	Typ	KW	Herstellereinschränkung	Kompressor-ID	Riemenscheiben-Ø [mm]	Rippenanzahl	Spannung [V]	Zylinderkopf-ID (Kompressor)	Einlass-Ø [mm]	Auslass-Ø [mm]
851746N	Case International IHC	Mähdrescher / 16	1680E	0	Sanden	SD508	152	2	12	M	20,5	20,5
850423N	Case International IHC	Mähdrescher / 16	1680E	0	York	T209/210R					16	16
851746N	Case International IHC	Mähdrescher / 16	1688	0	Sanden	SD508	152	2	12	M	20,5	20,5
850874N	Case International IHC	Mähdrescher / 21	2144	0	Sanden	SD7H15HD	152	2	12	MD	14,5	14,5
850874N	Case International IHC	Mähdrescher / 21	2166	0	Sanden	SD7H15HD	152	2	12	MD	14,5	14,5
850874N	Case International IHC	Mähdrescher / 21	2188	0	Sanden	SD7H15HD	152	2	12	MD	14,5	14,5
850874N	Case International IHC	Mähdrescher / 23	2344	0	Sanden	SD7H15HD	152	2	12	MD	14,5	14,5
850874N	Case International IHC	Mähdrescher / 23	2365	0	Sanden	SD7H15HD	152	2	12	MD	14,5	14,5
850874N	Case International IHC	Mähdrescher / 23	2366	0	Sanden	SD7H15HD	152	2	12	MD	14,5	14,5
850874N	Case International IHC	Mähdrescher / 23	2388	0	Sanden	SD7H15HD	152	2	12	MD	14,5	14,5
851722N	Case International IHC	Mähdrescher / AFX	8010	0	Sanden	SD7H15HD	152	8	12	MD		
850875N	Case International IHC	Mähdrescher / CT	5050	0	Sanden	SD7H15	132	2	12	KG		
850875N	Case International IHC	Mähdrescher / CT	5060	0	Sanden	SD7H15	132	2	12	KG		
850875N	Case International IHC	Mähdrescher / CT	5070	0	Sanden	SD7H15	132	2	12	KG		

Dasis Nr.	Hersteller	Modell	Typ	KW	Herstellereinschränkung	Kompressor-ID	Riemenscheiben-Ø [mm]	Rippenanzahl	Spannung [V]	Zylinderkopf-ID (Kompressor)	Einlass-Ø [mm]	Auslass-Ø [mm]
850875N	Case International IHC	Mähdrescher / CT	5080	0	Sanden	SD7H15	132	2	12	KG		
850414N	Case International IHC	Mähdrescher / JXN	1060V	0	Sanden	SD5H14	132	2	12	M	13	11
850414N	Case International IHC	Mähdrescher / JXN	1070V	0	Sanden	SD5H14	132	2	12	M	13	11
850414N	Case International IHC	Mähdrescher / JXN	1075V	0	Sanden	SD5H14	132	2	12	M	13	11
850875N	Case International IHC	Mähdrescher 521-1150	525	0	Sanden	SD7H15	132	2	12	KG		
850875N	Case International IHC	Mähdrescher 521-1150	527	0	Sanden	SD7H15	132	2	12	KG		
850874N	Case International IHC	Raupen Dozer	750K	0	Sanden	SD7H15HD	152	2	12	MD	14,5	14,5
850874N	Case International IHC	Raupen Dozer	780	0	Sanden	SD7H15HD	152	2	12	MD	14,5	14,5
850874N	Case International IHC	Raupen Dozer	850E	0	Sanden	SD7H15HD	152	2	12	MD	14,5	14,5
850874N	Case International IHC	Raupen Dozer	850G	0	Sanden	SD7H15HD	152	2	12	MD	14,5	14,5
850874N	Case International IHC	Raupen Dozer	850H	0	Sanden	SD7H15HD	152	2	12	MD	14,5	14,5
850874N	Case International IHC	Raupen Dozer	850K	0	Sanden	SD7H15HD	152	2	12	MD	14,5	14,5
850874N	Case International IHC	Raupen Dozer / Quadtrac	Quadtrac	0	Sanden	SD7H15HD	152	2	12	MD	14,5	14,5
850874N	Case International IHC	Schaufellader	570L2	0	Sanden	SD7H15HD	152	2	12	MD	14,5	14,5

Dasis Nr.	Hersteller	Modell	Typ	KW	Herstellereinschränkung	Kompressor-ID	Riemenscheiben-Ø [mm]	Rippenanzahl	Spannung [V]	Zylinderkopf-ID (Kompressor)	Einlass-Ø [mm]	Auslass-Ø [mm]
850874N	Case International IHC	Schaufellader	1150H	0	Sanden	SD7H15HD	152	2	12	MD	14,5	14,5
850352N	Case International IHC	Schaufellader	W14	0	York	T209/210L					14,9	14,9
850352N	Case International IHC	Schaufellader	W18	0	York	T209/210L					14,9	14,9
850352N	Case International IHC	Schaufellader	W20	0	York	T209/210L					14,9	14,9
850352N	Case International IHC	Schaufellader	W20C	0	York	T209/210L					14,9	14,9
851746N	Case International IHC	Schlepper / 186-996	385	0	Sanden	SD508	152	2	12	M	20,5	20,5
851746N	Case International IHC	Schlepper / 186-996	395	0	Sanden	SD508	152	2	12	M	20,5	20,5
851746N	Case International IHC	Schlepper / 186-996	485	0	Sanden	SD508	152	2	12	M	20,5	20,5
851746N	Case International IHC	Schlepper / 186-996	495	0	Sanden	SD508	152	2	12	M	20,5	20,5
851746N	Case International IHC	Schlepper / 186-996	585	0	Sanden	SD508	152	2	12	M	20,5	20,5
858453N	Case International IHC	Schlepper / 186-996	595	0	Sanden	SD508	132	2	12			
851746N	Case International IHC	Schlepper / 186-996	685	0	Sanden	SD508	152	2	12	M	20,5	20,5
858453N	Case International IHC	Schlepper / 186-996	695	0	Sanden	SD508	132	2	12			
851746N	Case International IHC	Schlepper / 186-996	785	0	Sanden	SD508	152	2	12	M	20,5	20,5

Dasis Nr.	Hersteller	Modell	Typ	KW	Herstellereinschränkung	Kompressor-ID	Riemenscheiben-Ø [mm]	Rippenanzahl	Spannung [V]	Zylinderkopf-ID (Kompressor)	Einlass-Ø [mm]	Auslass-Ø [mm]
850422N	Case International IHC	Schlepper / 186-996	786	0	York	R209/210R	ohne Riemenscheibe	ohne Riemenscheibe			13,5	13,5
858453N	Case International IHC	Schlepper / 186-996	795	0	Sanden	SD508	132	2	12			
850873N	Case International IHC	Schlepper / 186-996	856	0	Sanden	SD510HD	132	2	12	M	13,5	13,5
851746N	Case International IHC	Schlepper / 186-996	885	0	Sanden	SD508	152	2	12	M	20,5	20,5
850422N	Case International IHC	Schlepper / 186-996	886	0	York	R209/210R	ohne Riemenscheibe	ohne Riemenscheibe			13,5	13,5
858453N	Case International IHC	Schlepper / 186-996	895	0	Sanden	SD508	132	2	12			
850873N	Case International IHC	Schlepper / 186-996	955	0	Sanden	SD510HD	132	2	12	M	13,5	13,5
850873N	Case International IHC	Schlepper / 186-996	956	0	Sanden	SD510HD	132	2	12	M	13,5	13,5
851746N	Case International IHC	Schlepper / 186-996	985	0	Sanden	SD508	152	2	12	M	20,5	20,5
850422N	Case International IHC	Schlepper / 186-996	986	0	York	R209/210R	ohne Riemenscheibe	ohne Riemenscheibe			13,5	13,5
858453N	Case International IHC	Schlepper / 186-996	995	0	Sanden	SD508	132	2	12			
850873N	Case International IHC	Schlepper / 1046-1896	1055	0	Sanden	SD510HD	132	2	12	M	13,5	13,5
850873N	Case International IHC	Schlepper / 1046-1896	1056	0	Sanden	SD510HD	132	2	12	M	13,5	13,5
850422N	Case International IHC	Schlepper / 1046-1896	1086	0	York	R209/210R	ohne Riemenscheibe	ohne Riemenscheibe			13,5	13,5

Dasis Nr.	Hersteller	Modell	Typ	KW	Herstellereinschränkung	Kompressor-ID	Riemenscheiben-Ø [mm]	Rippenanzahl	Spannung [V]	Zylinderkopf-ID (Kompressor)	Einlass-Ø [mm]	Auslass-Ø [mm]
850873N	Case International IHC	Schlepper / 1046-1896	1255	0	Sanden	SD510HD	132	2	12	M	13,5	13,5
858485N	Case International IHC	Schlepper / 1046-1896	1294	0	Sanden	SD5H14	132	2	12	B		
858485N	Case International IHC	Schlepper / 1046-1896	1394	0	Sanden	SD5H14	132	2	12	B		
850873N	Case International IHC	Schlepper / 1046-1896	1455	0	Sanden	SD510HD	132	2	12	M	13,5	13,5
850422N	Case International IHC	Schlepper / 1046-1896	1486	0	York	R209/210R	ohne Riemenscheibe	ohne Riemenscheibe			13,5	13,5
858485N	Case International IHC	Schlepper / 1046-1896	1494	0	Sanden	SD5H14	132	2	12	B		
850422N	Case International IHC	Schlepper / 1046-1896	1586	0	York	R209/210R	ohne Riemenscheibe	ohne Riemenscheibe			13,5	13,5
858485N	Case International IHC	Schlepper / 1046-1896	1594	0	Sanden	SD5H14	132	2	12	B		
850870N	Case International IHC	Schlepper / 1046-1896	1896	0	Sanden	SD5H14	132	2	12	FG	16	13
850870N	Case International IHC	Schlepper / 2096-2388	2096	0	Sanden	SD5H14	132	2	12	FG	16	13
850422N	Case International IHC	Schlepper / 3088-3788	3088	0	York	R209/210R	ohne Riemenscheibe	ohne Riemenscheibe			13,5	13,5
850874N	Case International IHC	Schlepper / 3088-3788	3210	0	Sanden	SD7H15HD	152	2	12	MD	14,5	14,5
850874N	Case International IHC	Schlepper / 3088-3788	3220	0	Sanden	SD7H15HD	152	2	12	MD	14,5	14,5
850874N	Case International IHC	Schlepper / 3088-3788	3230	0	Sanden	SD7H15HD	152	2	12	MD	14,5	14,5

Dasis Nr.	Hersteller	Modell	Typ	KW	Herstellereinschränkung	Kompressor-ID	Riemenscheiben-Ø [mm]	Rippenanzahl	Spannung [V]	Zylinderkopf-ID (Kompressor)	Einlass-Ø [mm]	Auslass-Ø [mm]
850422N	Case International IHC	Schlepper / 3088-3788	3288	0	York	R209/210R	ohne Riemenscheibe	ohne Riemenscheibe			13,5	13,5
850422N	Case International IHC	Schlepper / 3088-3788	3388	0	York	R209/210R	ohne Riemenscheibe	ohne Riemenscheibe			13,5	13,5
850422N	Case International IHC	Schlepper / 3088-3788	3488	0	York	R209/210R	ohne Riemenscheibe	ohne Riemenscheibe			13,5	13,5
850422N	Case International IHC	Schlepper / 3088-3788	3588	0	York	R209/210R	ohne Riemenscheibe	ohne Riemenscheibe			13,5	13,5
850422N	Case International IHC	Schlepper / 3088-3788	3688	0	York	R209/210R	ohne Riemenscheibe	ohne Riemenscheibe			13,5	13,5
850422N	Case International IHC	Schlepper / 3088-3788	3788	0	York	R209/210R	ohne Riemenscheibe	ohne Riemenscheibe			13,5	13,5
850422N	Case International IHC	Schlepper / 4000-4894	4186	0	York	R209/210R	ohne Riemenscheibe	ohne Riemenscheibe			13,5	13,5
850874N	Case International IHC	Schlepper / 4000-4894	4210	0	Sanden	SD7H15HD	152	2	12	MD	14,5	14,5
850874N	Case International IHC	Schlepper / 4000-4894	4220	0	Sanden	SD7H15HD	152	2	12	MD	14,5	14,5
850874N	Case International IHC	Schlepper / 4000-4894	4230	0	Sanden	SD7H15HD	152	2	12	MD	14,5	14,5
850874N	Case International IHC	Schlepper / 4000-4894	4240	0	Sanden	SD7H15HD	152	2	12	MD	14,5	14,5
850422N	Case International IHC	Schlepper / 4000-4894	4386	0	York	R209/210R	ohne Riemenscheibe	ohne Riemenscheibe			13,5	13,5
850870N	Case International IHC	Schlepper / 4000-4894	4494	0	Sanden	SD5H14	132	2	12	FG	16	13
850422N	Case International IHC	Schlepper / 4000-4894	4586	0	York	R209/210R	ohne Riemenscheibe	ohne Riemenscheibe			13,5	13,5



Dasis Nr.	Hersteller	Modell	Typ	KW	Herstellereinschränkung	Kompressor-ID	Riemenscheiben-Ø [mm]	Rippenanzahl	Spannung [V]	Zylinderkopf-ID (Kompressor)	Einlass-Ø [mm]	Auslass-Ø [mm]
850870N	Case International IHC	Schlepper / 4000-4894	4694	0	Sanden	SD5H14	132	2	12	FG	16	13
850422N	Case International IHC	Schlepper / 4000-4894	4786	0	York	R209/210R	ohne Riemenscheibe	ohne Riemenscheibe			13,5	13,5
850874N	Case International IHC	Schlepper / 5088-5488	5120	0	Sanden	SD7H15HD	152	2	12	MD	14,5	14,5
851746N	Case International IHC	Schlepper / 5088-5488	5120	0	Sanden	SD508	152	2	12	M	20,5	20,5
850874N	Case International IHC	Schlepper / 5088-5488	5130	0	Sanden	SD7H15HD	152	2	12	MD	14,5	14,5
851746N	Case International IHC	Schlepper / 5088-5488	5130	0	Sanden	SD508	152	2	12	M	20,5	20,5
850874N	Case International IHC	Schlepper / 5088-5488	5140	0	Sanden	SD7H15HD	152	2	12	MD	14,5	14,5
851746N	Case International IHC	Schlepper / 5088-5488	5140	0	Sanden	SD508	152	2	12	M	20,5	20,5
850874N	Case International IHC	Schlepper / 5088-5488	5150	0	Sanden	SD7H15HD	152	2	12	MD	14,5	14,5
851746N	Case International IHC	Schlepper / 5088-5488	5150	0	Sanden	SD508	152	2	12	M	20,5	20,5
850874N	Case International IHC	Schlepper / 5088-5488	5220	0	Sanden	SD7H15HD	152	2	12	MD	14,5	14,5
851746N	Case International IHC	Schlepper / 5088-5488	5220	0	Sanden	SD508	152	2	12	M	20,5	20,5
850874N	Case International IHC	Schlepper / 5088-5488	5230	0	Sanden	SD7H15HD	152	2	12	MD	14,5	14,5
851746N	Case International IHC	Schlepper / 5088-5488	5230	0	Sanden	SD508	152	2	12	M	20,5	20,5

Dasis Nr.	Hersteller	Modell	Typ	KW	Herstellereinschränkung	Kompressor-ID	Riemenscheiben-Ø [mm]	Rippenanzahl	Spannung [V]	Zylinderkopf-ID (Kompressor)	Einlass-Ø [mm]	Auslass-Ø [mm]
850874N	Case International IHC	Schlepper / 5088-5488	5240	0	Sanden	SD7H15HD	152	2	12	MD	14,5	14,5
851746N	Case International IHC	Schlepper / 5088-5488	5240	0	Sanden	SD508	152	2	12	M	20,5	20,5
850874N	Case International IHC	Schlepper / 5088-5488	5250	0	Sanden	SD7H15HD	152	2	12	MD	14,5	14,5
851746N	Case International IHC	Schlepper / 5088-5488	5250	0	Sanden	SD508	152	2	12	M	20,5	20,5
851746N	Case International IHC	Schlepper / 7110-7488	7110	0	Sanden	SD508	152	2	12	M	20,5	20,5
851746N	Case International IHC	Schlepper / 7110-7488	7110E	0	Sanden	SD508	152	2	12	M	20,5	20,5
851746N	Case International IHC	Schlepper / 7110-7488	7120	0	Sanden	SD508	152	2	12	M	20,5	20,5
851746N	Case International IHC	Schlepper / 7110-7488	7120E	0	Sanden	SD508	152	2	12	M	20,5	20,5
851746N	Case International IHC	Schlepper / 7110-7488	7130	0	Sanden	SD508	152	2	12	M	20,5	20,5
851746N	Case International IHC	Schlepper / 7110-7488	7140	0	Sanden	SD508	152	2	12	M	20,5	20,5
851746N	Case International IHC	Schlepper / 7110-7488	7150	0	Sanden	SD508	152	2	12	M	20,5	20,5
850874N	Case International IHC	Schlepper / 7110-7488	7210	0	Sanden	SD7H15HD	152	2	12	MD	14,5	14,5
850874N	Case International IHC	Schlepper / 7110-7488	7220	0	Sanden	SD7H15HD	152	2	12	MD	14,5	14,5
850874N	Case International IHC	Schlepper / 7110-7488	7230	0	Sanden	SD7H15HD	152	2	12	MD	14,5	14,5

Dasis Nr.	Hersteller	Modell	Typ	KW	Herstellereinschränkung	Kompressor-ID	Riemenscheiben-Ø [mm]	Rippenanzahl	Spannung [V]	Zylinderkopf-ID (Kompressor)	Einlass-Ø [mm]	Auslass-Ø [mm]
850874N	Case International IHC	Schlepper / 7110-7488	7240	0	Sanden	SD7H15HD	152	2	12	MD	14,5	14,5
850874N	Case International IHC	Schlepper / 7110-7488	7250	0	Sanden	SD7H15HD	152	2	12	MD	14,5	14,5
850874N	Case International IHC	Schlepper / 8910-8950	8910	0	Sanden	SD7H15HD	152	2	12	MD	14,5	14,5
850874N	Case International IHC	Schlepper / 8910-8950	8920	0	Sanden	SD7H15HD	152	2	12	MD	14,5	14,5
850874N	Case International IHC	Schlepper / 8910-8950	8930	0	Sanden	SD7H15HD	152	2	12	MD	14,5	14,5
850874N	Case International IHC	Schlepper / 8910-8950	8940	0	Sanden	SD7H15HD	152	2	12	MD	14,5	14,5
850874N	Case International IHC	Schlepper / 8910-8950	8950	0	Sanden	SD7H15HD	152	2	12	MD	14,5	14,5
850874N	Case International IHC	Schlepper / 9110-9390	9210	0	Sanden	SD7H15HD	152	2	12	MD	14,5	14,5
850874N	Case International IHC	Schlepper / 9110-9390	9230	0	Sanden	SD7H15HD	152	2	12	MD	14,5	14,5
850874N	Case International IHC	Schlepper / 9110-9390	9240	0	Sanden	SD7H15HD	152	2	12	MD	14,5	14,5
850874N	Case International IHC	Schlepper / 9110-9390	9250	0	Sanden	SD7H15HD	152	2	12	MD	14,5	14,5
850874N	Case International IHC	Schlepper / 9110-9390	9260	0	Sanden	SD7H15HD	152	2	12	MD	14,5	14,5
850874N	Case International IHC	Schlepper / 9110-9390	9270	0	Sanden	SD7H15HD	152	2	12	MD	14,5	14,5
850874N	Case International IHC	Schlepper / 9110-9390	9280	0	Sanden	SD7H15HD	152	2	12	MD	14,5	14,5

Dasis Nr.	Hersteller	Modell	Typ	KW	Herstellereinschränkung	Kompressor-ID	Riemenscheiben-Ø [mm]	Rippenanzahl	Spannung [V]	Zylinderkopf-ID (Kompressor)	Einlass-Ø [mm]	Auslass-Ø [mm]
850874N	Case International IHC	Schlepper / CS	75	0	Sanden	SD7H15HD	152	2	12	MD	14,5	14,5
851703N	Case International IHC	Schlepper / CS	75	0	Seltec	TM-16HD	135	2	12		13	16
850874N	Case International IHC	Schlepper / CS	78	0	Sanden	SD7H15HD	152	2	12	MD	14,5	14,5
851703N	Case International IHC	Schlepper / CS	78	0	Seltec	TM-16HD	135	2	12		13	16
850874N	Case International IHC	Schlepper / CS	86	0	Sanden	SD7H15HD	152	2	12	MD	14,5	14,5
851703N	Case International IHC	Schlepper / CS	86	0	Seltec	TM-16HD	135	2	12		13	16
850874N	Case International IHC	Schlepper / CS	94	0	Sanden	SD7H15HD	152	2	12	MD	14,5	14,5
851703N	Case International IHC	Schlepper / CS	94	0	Seltec	TM-16HD	135	2	12		13	16
850874N	Case International IHC	Schlepper / CS	100	0	Sanden	SD7H15HD	152	2	12	MD	14,5	14,5
851703N	Case International IHC	Schlepper / CS	100	0	Seltec	TM-16HD	135	2	12		13	16
850874N	Case International IHC	Schlepper / CS	110	0	Sanden	SD7H15HD	152	2	12	MD	14,5	14,5
851703N	Case International IHC	Schlepper / CS	110	0	Seltec	TM-16HD	135	2	12		13	16
850874N	Case International IHC	Schlepper / CS	120	0	Sanden	SD7H15HD	152	2	12	MD	14,5	14,5
851703N	Case International IHC	Schlepper / CS	120	0	Seltec	TM-16HD	135	2	12		13	16

Dasis Nr.	Hersteller	Modell	Typ	KW	Herstellereinschränkung	Kompressor-ID	Riemenscheiben-Ø [mm]	Rippenanzahl	Spannung [V]	Zylinderkopf-ID (Kompressor)	Einlass-Ø [mm]	Auslass-Ø [mm]
850874N	Case International IHC	Schlepper / CS	130	0	Sanden	SD7H15HD	152	2	12	MD	14,5	14,5
851703N	Case International IHC	Schlepper / CS	130	0	Seltec	TM-16HD	135	2	12		13	16
850874N	Case International IHC	Schlepper / CS	150	0	Sanden	SD7H15HD	152	2	12	MD	14,5	14,5
851703N	Case International IHC	Schlepper / CS	150	0	Seltec	TM-16HD	135	2	12		13	16
850874N	Case International IHC	Schlepper / CVX	V120	0	Sanden	SD7H15HD	152	2	12	MD	14,5	14,5
850874N	Case International IHC	Schlepper / CVX	V130	0	Sanden	SD7H15HD	152	2	12	MD	14,5	14,5
850874N	Case International IHC	Schlepper / CVX	V150	0	Sanden	SD7H15HD	152	2	12	MD	14,5	14,5
850874N	Case International IHC	Schlepper / CVX	V170	0	Sanden	SD7H15HD	152	2	12	MD	14,5	14,5
850874N	Case International IHC	Schlepper / CVX	V1135	0	Sanden	SD7H15HD	152	2	12	MD	14,5	14,5
850874N	Case International IHC	Schlepper / CVX	V1145	0	Sanden	SD7H15HD	152	2	12	MD	14,5	14,5
850874N	Case International IHC	Schlepper / CVX	V1155	0	Sanden	SD7H15HD	152	2	12	MD	14,5	14,5
850874N	Case International IHC	Schlepper / CVX	V1170	0	Sanden	SD7H15HD	152	2	12	MD	14,5	14,5
850874N	Case International IHC	Schlepper / CVX	V1190	0	Sanden	SD7H15HD	152	2	12	MD	14,5	14,5
850874N	Case International IHC	Schlepper / CX	50	0	Sanden	SD7H15HD	152	2	12	MD	14,5	14,5

Dasis Nr.	Hersteller	Modell	Typ	KW	Herstellereinschränkung	Kompressor-ID	Riemenscheiben-Ø [mm]	Rippenanzahl	Spannung [V]	Zylinderkopf-ID (Kompressor)	Einlass-Ø [mm]	Auslass-Ø [mm]
850874N	Case International IHC	Schlepper / CX	60	0	Sanden	SD7H15HD	152	2	12	MD	14,5	14,5
850874N	Case International IHC	Schlepper / CX	70	0	Sanden	SD7H15HD	152	2	12	MD	14,5	14,5
850874N	Case International IHC	Schlepper / CX	80	0	Sanden	SD7H15HD	152	2	12	MD	14,5	14,5
850874N	Case International IHC	Schlepper / CX	90	0	Sanden	SD7H15HD	152	2	12	MD	14,5	14,5
850874N	Case International IHC	Schlepper / CX	100	0	Sanden	SD7H15HD	152	2	12	MD	14,5	14,5
852992N	Case International IHC	Schlepper / Farmall U Serie	95U	0	Sanden	SD7H15	112	6	12		13	13
852992N	Case International IHC	Schlepper / Farmall U Serie	105U	0	Sanden	SD7H15	112	6	12		13	13
852992N	Case International IHC	Schlepper / Farmall U Serie	110U	0	Sanden	SD7H15	112	6	12		13	13
852992N	Case International IHC	Schlepper / Farmall U Serie	115U	0	Sanden	SD7H15	112	6	12		13	13
852992N	Case International IHC	Schlepper / Farmall U Serie	120U	0	Sanden	SD7H15	112	6	12		13	13
851756N	Case International IHC	Schlepper / FLX	3300B	0	Sanden	SD7H15	133	8	12	JD	16	12
851724N	Case International IHC	Schlepper / JX	55	0								
851724N	Case International IHC	Schlepper / JX	60	0								
851724N	Case International IHC	Schlepper / JX	65	0								

Dasis Nr.	Hersteller	Modell	Typ	KW	Herstellereinschränkung	Kompressor-ID	Riemenscheiben-Ø [mm]	Rippenanzahl	Spannung [V]	Zylinderkopf-ID (Kompressor)	Einlass-Ø [mm]	Auslass-Ø [mm]
851724N	Case International IHC	Schlepper / JX	70	0								
851724N	Case International IHC	Schlepper / JX	75	0								
851724N	Case International IHC	Schlepper / JX	80	0								
851724N	Case International IHC	Schlepper / JX	85	0								
851724N	Case International IHC	Schlepper / JX	90	0								
851724N	Case International IHC	Schlepper / JX	95	0								
850414N	Case International IHC	Schlepper / JX	1060	0	Sanden	SD5H14	132	2	12	M	13	11
850414N	Case International IHC	Schlepper / JX	1070	0	Sanden	SD5H14	132	2	12	M	13	11
852159N	Case International IHC	Schlepper / JX	1075	0	Sanden	SD7H15	125	2	12	OB	14,5	14,5
850414N	Case International IHC	Schlepper / JXU	1070U	0	Sanden	SD5H14	132	2	12	M	13	11
850414N	Case International IHC	Schlepper / JXU	1080U	0	Sanden	SD5H14	132	2	12	M	13	11
850414N	Case International IHC	Schlepper / JXU	1090U	0	Sanden	SD5H14	132	2	12	M	13	11
850414N	Case International IHC	Schlepper / JXU	1100U	0	Sanden	SD5H14	132	2	12	M	13	11
850874N	Case International IHC	Schlepper / MX	100	0	Sanden	SD7H15HD	152	2	12	MD	14,5	14,5

Dasis Nr.	Hersteller	Modell	Typ	KW	Herstellereinschränkung	Kompressor-ID	Riemenscheiben-Ø [mm]	Rippenanzahl	Spannung [V]	Zylinderkopf-ID (Kompressor)	Einlass-Ø [mm]	Auslass-Ø [mm]
850874N	Case International IHC	Schlepper / MX	110	0	Sanden	SD7H15HD	152	2	12	MD	14,5	14,5
850874N	Case International IHC	Schlepper / MX	120	0	Sanden	SD7H15HD	152	2	12	MD	14,5	14,5
850874N	Case International IHC	Schlepper / MX	135	0	Sanden	SD7H15HD	152	2	12	MD	14,5	14,5
850874N	Case International IHC	Schlepper / MX	150	0	Sanden	SD7H15HD	152	2	12	MD	14,5	14,5
851722N	Case International IHC	Schlepper / MX	210	0	Sanden	SD7H15HD	152	8	12	MD		
851722N	Case International IHC	Schlepper / MX	230	0	Sanden	SD7H15HD	152	8	12	MD		
851722N	Case International IHC	Schlepper / MX	255	0	Sanden	SD7H15HD	152	8	12	MD		
851722N	Case International IHC	Schlepper / MX	285	0	Sanden	SD7H15HD	152	8	12	MD		
850888N	Case International IHC	Schlepper / MXM	120	0								
850888N	Case International IHC	Schlepper / MXM	130	0								
851785N	Case International IHC	Schlepper / MXM	135	0	Sanden	SD7H15	120	8	12	JD	12,8	14,5
850888N	Case International IHC	Schlepper / MXM	140	0								
851785N	Case International IHC	Schlepper / MXM	150	0	Sanden	SD7H15	120	8	12	JD	12,8	14,5
850888N	Case International IHC	Schlepper / MXM	155	0								



Dasis Nr.	Hersteller	Modell	Typ	KW	Herstellereinschränkung	Kompressor-ID	Riemenscheiben-Ø [mm]	Rippenanzahl	Spannung [V]	Zylinderkopf-ID (Kompressor)	Einlass-Ø [mm]	Auslass-Ø [mm]
851785N	Case International IHC	Schlepper / MXM	165	0	Sanden	SD7H15	120	8	12	JD	12,8	14,5
850888N	Case International IHC	Schlepper / MXM	175	0								
851785N	Case International IHC	Schlepper / MXM	180	0	Sanden	SD7H15	120	8	12	JD	12,8	14,5
850888N	Case International IHC	Schlepper / MXM	190	0								
851786N	Case International IHC	Schlepper / MXU	100	0	Sanden	SD7H15	112	4	12	WV	17,7	14,5
851786N	Case International IHC	Schlepper / MXU	110	0	Sanden	SD7H15	112	4	12	WV	17,7	14,5
851786N	Case International IHC	Schlepper / MXU	115	0	Sanden	SD7H15	112	4	12	WV	17,7	14,5
851786N	Case International IHC	Schlepper / MXU	125	0	Sanden	SD7H15	112	4	12	WV	17,7	14,5
851786N	Case International IHC	Schlepper / MXU	135	0	Sanden	SD7H15	112	4	12	WV	17,7	14,5
850892N	Case International IHC	Schlepper / PJN	65	0	Sanden	7H15	132	2	12	MJ	15	15
850892N	Case International IHC	Schlepper / PJN	75	0	Sanden	7H15	132	2	12	MJ	15	15
850892N	Case International IHC	Schlepper / PJV	65	0	Sanden	7H15	132	2	12	MJ	15	15
850892N	Case International IHC	Schlepper / PJV	75	0	Sanden	7H15	132	2	12	MJ	15	15
850422N	Case International IHC	Schlepper / PJV Hydro	100	0	York	R209/210R	ohne Riemenscheibe	ohne Riemenscheibe			13,5	13,5

Dasis Nr.	Hersteller	Modell	Typ	KW	Herstellereinschränkung	Kompressor-ID	Riemenscheiben-Ø [mm]	Rippenanzahl	Spannung [V]	Zylinderkopf-ID (Kompressor)	Einlass-Ø [mm]	Auslass-Ø [mm]
850422N	Case International IHC	Schlepper / PJV Hydro	186	0	York	R209/210R	ohne Riemenscheibe	ohne Riemenscheibe			13,5	13,5
852996N	Case International IHC	Schlepper / Puma CVT Serie	185	0	Sanden	SD7H15	119	10	12		12	15
852996N	Case International IHC	Schlepper / Puma CVT Serie	200	0	Sanden	SD7H15	119	10	12		12	15
852996N	Case International IHC	Schlepper / Puma CVT Serie	220	0	Sanden	SD7H15	119	10	12		12	15
852996N	Case International IHC	Schlepper / Puma CVT Serie	240	0	Sanden	SD7H15	119	10	12		12	15
852996N	Case International IHC	Schlepper / Puma CVX Serie	185	0	Sanden	SD7H15	119	10	12		12	15
852996N	Case International IHC	Schlepper / Puma CVX Serie	200	0	Sanden	SD7H15	119	10	12		12	15
852996N	Case International IHC	Schlepper / Puma CVX Serie	220	0	Sanden	SD7H15	119	10	12		12	15
852996N	Case International IHC	Schlepper / Puma CVX Serie	240	0	Sanden	SD7H15	119	10	12		12	15
850874N	Case International IHC	Schlepper / STX	275	0	Sanden	SD7H15HD	152	2	12	MD	14,5	14,5
850874N	Case International IHC	Schlepper / STX	325	0	Sanden	SD7H15HD	152	2	12	MD	14,5	14,5
850874N	Case International IHC	Schlepper / STX	375	0	Sanden	SD7H15HD	152	2	12	MD	14,5	14,5
850874N	Case International IHC	Schlepper / STX	425	0	Sanden	SD7H15HD	152	2	12	MD	14,5	14,5
850874N	Case International IHC	Schlepper / STX	440	0	Sanden	SD7H15HD	152	2	12	MD	14,5	14,5

Dasis Nr.	Hersteller	Modell	Typ	KW	Herstellereinschränkung	Kompressor-ID	Riemenscheiben-Ø [mm]	Rippenanzahl	Spannung [V]	Zylinderkopf-ID (Kompressor)	Einlass-Ø [mm]	Auslass-Ø [mm]
850874N	Case International IHC	Schlepper / STX	450	0	Sanden	SD7H15HD	152	2	12	MD	14,5	14,5
850874N	Case International IHC	Schlepper / STX	500	0	Sanden	SD7H15HD	152	2	12	MD	14,5	14,5
850352N	Case International IHC	Schlepper / W	W36	0	York	T209/210L					14,9	14,9
850414N	Case International IHC	Schlepper Obstbau / JXN	1070	0	Sanden	SD5H14	132	2	12	M	13	11
850414N	Case International IHC	Schlepper Obstbau / JXN	1075	0	Sanden	SD5H14	132	2	12	M	13	11
850874N	Case International IHC	SPX	3150	0	Sanden	SD7H15HD	152	2	12	MD	14,5	14,5
850874N	Case International IHC	SPX	3200	0	Sanden	SD7H15HD	152	2	12	MD	14,5	14,5
850874N	Case International IHC	SPX	4260	0	Sanden	SD7H15HD	152	2	12	MD	14,5	14,5
851732N	Caterpillar	Bagger 360 Grad / 200	257B	0	Seltec	TM-08	125	2	12			
850897N	Caterpillar	Bagger 360 Grad / 300BL	345	0	Sanden	SD7H15HD	138	1	12	GK	18	18
852088N	Caterpillar	Bagger 360 Grad / 300CL	330	0	Denso	10S17C	145	8	24	JD	15	18
853131N	Caterpillar	Bagger 360 Grad / 300 Serie	307C	0	Mitsubishi	MSC90T	130	1	24			
853131N	Caterpillar	Bagger 360 Grad / 300 Serie	311C U	0	Mitsubishi	MSC90T	130	1	24			
853131N	Caterpillar	Bagger 360 Grad / 300 Serie	320C	0	Mitsubishi	MSC90T	130	1	24			
853131N	Caterpillar	Bagger 360 Grad / 300 Serie	320C U	0	Mitsubishi	MSC90T	130	1	24			
852915N	Caterpillar	Bagger 360 Grad / 300 Serie	320D	0	Sanden	SD7H15	126	12	24	WR	15	12
852915N	Caterpillar	Bagger 360 Grad / 300 Serie	320E	0	Sanden	SD7H15	126	12	24	WR	15	12

Dasis Nr.	Hersteller	Modell	Typ	KW	Herstellereinschränkung	Kompressor-ID	Riemenscheiben-Ø [mm]	Rippenanzahl	Spannung [V]	Zylinderkopf-ID (Kompressor)	Einlass-Ø [mm]	Auslass-Ø [mm]
852915N	Caterpillar	Bagger 360 Grad / 300 Serie	320E L	0	Sanden	SD7H15	126	12	24	WR	15	12
852915N	Caterpillar	Bagger 360 Grad / 300 Serie	320E LN	0	Sanden	SD7H15	126	12	24	WR	15	12
852915N	Caterpillar	Bagger 360 Grad / 300 Serie	320E LRR	0	Sanden	SD7H15	126	12	24	WR	15	12
852915N	Caterpillar	Bagger 360 Grad / 300 Serie	320E RR	0	Sanden	SD7H15	126	12	24	WR	15	12
852915N	Caterpillar	Bagger 360 Grad / 300 Serie	323D	0	Sanden	SD7H15	126	12	24	WR	15	12
852915N	Caterpillar	Bagger 360 Grad / 300 Serie	323E L	0	Sanden	SD7H15	126	12	24	WR	15	12
852915N	Caterpillar	Bagger 360 Grad / 300 Serie	323E LN	0	Sanden	SD7H15	126	12	24	WR	15	12
852915N	Caterpillar	Bagger 360 Grad / 300 Serie	323E SA	0	Sanden	SD7H15	126	12	24	WR	15	12
852915N	Caterpillar	Bagger 360 Grad / 300 Serie	323F	0	Sanden	SD7H15	126	12	24	WR	15	12
852915N	Caterpillar	Bagger 360 Grad / 300 Serie	324E	0	Sanden	SD7H15	126	12	24	WR	15	12
852915N	Caterpillar	Bagger 360 Grad / 300 Serie	324E L	0	Sanden	SD7H15	126	12	24	WR	15	12
852915N	Caterpillar	Bagger 360 Grad / 300 Serie	324E LN	0	Sanden	SD7H15	126	12	24	WR	15	12
852915N	Caterpillar	Bagger 360 Grad / 300 Serie	326D	0	Sanden	SD7H15	126	12	24	WR	15	12
852915N	Caterpillar	Bagger 360 Grad / 300 Serie	326F L	0	Sanden	SD7H15	126	12	24	WR	15	12
852915N	Caterpillar	Bagger 360 Grad / 300 Serie	329D	0	Sanden	SD7H15	126	12	24	WR	15	12
852915N	Caterpillar	Bagger 360 Grad / 300 Serie	329F	0	Sanden	SD7H15	126	12	24	WR	15	12
852890N	Caterpillar	Bagger 360 Grad / 300 Serie	336E	0	Sanden	SD7H15	152	8	24	WR		
852890N	Caterpillar	Bagger 360 Grad / 300 Serie	336E H	0	Sanden	SD7H15	152	8	24	WR		
852890N	Caterpillar	Bagger 360 Grad / 300 Serie	336E L	0	Sanden	SD7H15	152	8	24	WR		
852890N	Caterpillar	Bagger 360 Grad / 300 Serie	336E LH	0	Sanden	SD7H15	152	8	24	WR		
852890N	Caterpillar	Bagger 360 Grad / 300 Serie	336E LN	0	Sanden	SD7H15	152	8	24	WR		

Dasis Nr.	Hersteller	Modell	Typ	KW	Herstellereinschränkung	Kompressor-ID	Riemenscheiben-Ø [mm]	Rippenanzahl	Spannung [V]	Zylinderkopf-ID (Kompressor)	Einlass-Ø [mm]	Auslass-Ø [mm]
852890N	Caterpillar	Bagger 360 Grad / 300 Serie	336E LNH	0	Sanden	SD7H15	152	8	24	WR		
852890N	Caterpillar	Bagger 360 Grad / 300 Serie	336F L	0	Sanden	SD7H15	152	8	24	WR		
852890N	Caterpillar	Bagger 360 Grad / 300 Serie	349E	0	Sanden	SD7H15	152	8	24	WR		
852890N	Caterpillar	Bagger 360 Grad / 300 Serie	349E L	0	Sanden	SD7H15	152	8	24	WR		
852890N	Caterpillar	Bagger 360 Grad / 300 Serie	349F	0	Sanden	SD7H15	152	8	24	WR		
852890N	Caterpillar	Bagger 360 Grad / 300 Serie	349F L	0	Sanden	SD7H15	152	8	24	WR		
852890N	Caterpillar	Bagger 360 Grad / 300 Serie	374F L	0	Sanden	SD7H15	152	8	24	WR		
852890N	Caterpillar	Bagger 360 Grad / 300 Serie	390F L	0	Sanden	SD7H15	152	8	24	WR		
850897N	Caterpillar	Baggerlader / 400	416	0	Sanden	SD7H15HD	138	1	12	GK	18	18
850897N	Caterpillar	Baggerlader / 400	416B	0	Sanden	SD7H15HD	138	1	12	GK	18	18
850897N	Caterpillar	Baggerlader / 400	426B	0	Sanden	SD7H15HD	138	1	12	GK	18	18
850897N	Caterpillar	Baggerlader / 400	428	0	Sanden	SD7H15HD	138	1	12	GK	18	18
850897N	Caterpillar	Baggerlader / 400	430	0	Sanden	SD7H15HD	138	1	12	GK	18	18
850897N	Caterpillar	Baggerlader / 400	436	0	Sanden	SD7H15HD	138	1	12	GK	18	18
850897N	Caterpillar	Baggerlader / 400	438	0	Sanden	SD7H15HD	138	1	12	GK	18	18
850897N	Caterpillar	Baggerlader / 400	442	0	Sanden	SD7H15HD	138	1	12	GK	18	18
850897N	Caterpillar	Baggerlader / 400B	416	0	Sanden	SD7H15HD	138	1	12	GK	18	18
850897N	Caterpillar	Baggerlader / 400C	436	0	Sanden	SD7H15HD	138	1	12	GK	18	18
850897N	Caterpillar	Baggerlader / 400C	438	0	Sanden	SD7H15HD	138	1	12	GK	18	18
850897N	Caterpillar	Baggerlader / 400D	428	0	Sanden	SD7H15HD	138	1	12	GK	18	18
850897N	Caterpillar	Baggerlader / 400D	430	0	Sanden	SD7H15HD	138	1	12	GK	18	18

Dasis Nr.	Hersteller	Modell	Typ	KW	Herstellereinschränkung	Kompressor-ID	Riemenscheiben-Ø [mm]	Rippenanzahl	Spannung [V]	Zylinderkopf-ID (Kompressor)	Einlass-Ø [mm]	Auslass-Ø [mm]
850897N	Caterpillar	Baggerlader / 400D	442	0	Sanden	SD7H15HD	138	1	12	GK	18	18
852993N	Caterpillar	Baggerlader / 400E	416E	0	Sanden	SD7H15	119	8	12		16	16
852993N	Caterpillar	Baggerlader / 400E	420E	0	Sanden	SD7H15	119	8	12		16	16
852993N	Caterpillar	Baggerlader / 400E	422E	0	Sanden	SD7H15	119	8	12		16	16
852993N	Caterpillar	Baggerlader / 400E	428E	0	Sanden	SD7H15	119	8	12		16	16
852993N	Caterpillar	Baggerlader / 400E	430E	0	Sanden	SD7H15	119	8	12		16	16
852993N	Caterpillar	Baggerlader / 400E	432E	0	Sanden	SD7H15	119	8	12		16	16
852993N	Caterpillar	Baggerlader / 400E	434E	0	Sanden	SD7H15	119	8	12		16	16
852993N	Caterpillar	Baggerlader / 400E	444E	0	Sanden	SD7H15	119	8	12		16	16
852993N	Caterpillar	Baggerlader / 400F	420F	0	Sanden	SD7H15	119	8	12		16	16
852993N	Caterpillar	Baggerlader / 400F	428F	0	Sanden	SD7H15	119	8	12		16	16
852993N	Caterpillar	Baggerlader / 400F	430F	0	Sanden	SD7H15	119	8	12		16	16
852993N	Caterpillar	Baggerlader / 400F	432F	0	Sanden	SD7H15	119	8	12		16	16
852993N	Caterpillar	Baggerlader / 400F	434F	0	Sanden	SD7H15	119	8	12		16	16
852993N	Caterpillar	Baggerlader / 400F	444F	0	Sanden	SD7H15	119	8	12		16	16
851725N	Caterpillar	Kniekgelenke Truck / 700	725	0	Sanden	SD7H15	133	8	24			
851725N	Caterpillar	Kniekgelenke Truck / 700	730	0	Sanden	SD7H15	133	8	24			
851725N	Caterpillar	Kniekgelenke Truck / 700	735	0	Sanden	SD7H15	133	8	24			
851725N	Caterpillar	Kniekgelenke Truck / 700	740	0	Sanden	SD7H15	133	8	24			
851736N	Caterpillar	Kniekgelenke Truck / D	25	0	Sanden	SD7H15HD	138	1	24	GK	16,4	16,4
851736N	Caterpillar	Kniekgelenke Truck / D	30	0	Sanden	SD7H15HD	138	1	24	GK	16,4	16,4

Dasis Nr.	Hersteller	Modell	Typ	KW	Herstellereinschränkung	Kompressor-ID	Riemenscheiben-Ø [mm]	Rippenanzahl	Spannung [V]	Zylinderkopf-ID (Kompressor)	Einlass-Ø [mm]	Auslass-Ø [mm]
851736N	Caterpillar	Kniegelenke Truck / D	350	0	Sanden	SD7H15HD	138	1	24	GK	16,4	16,4
851753N	Caterpillar	Kompressor Harrison	GMA6	0	GM Harrison	A6	139	1	12		16	16
851097N	Caterpillar	Kompressor Harrison	GMA6	0	GM Harrison	A6	172	1	12			
850685N	Caterpillar	Kompressor Harrison	GMA6 24V	0								
851760N	Caterpillar	Kompressor Nippondenso	10S17C	0	Denso	10S17C	135	1	24		14	16
851748N	Caterpillar	Kompressor Sanden	SD7H15	0	Sanden	SD7H15	125	2	12	SJA		
851756N	Caterpillar	Kompressor Sanden	SD7H15	0	Sanden	SD7H15	133	8	12	JD	16	12
851774N	Caterpillar	Kompressor Sanden	SD7H15	0	Sanden	SD7H15	133	8	12		16,5	16,5
851749N	Caterpillar	Kompressor Sanden	SD7H15	0	Sanden	SD7H15HD	152	8	24	MD	18	18
850456N	Caterpillar	Kompressor Sanden	SD508	0	Sanden	SD508	132	2	12			
858485N	Caterpillar	Kompressor Sanden	SD510	0	Sanden	SD5H14	132	2	12	B		
851744N	Caterpillar	Kompressor Sanden	SD510HD	0								
851717N	Caterpillar	Kompressor Sanden FLX	FLX7	0	Sanden	SD7H15-FLX7	135	2	12	GV	15	15
851723N	Caterpillar	Kompressor Sanden FLX	FLX7	0	Sanden	SD7H15-FLX7	135	2	24	GV	14	14
851779N	Caterpillar	Kompressor TE	HG850-1000	0	Tecumseh	HG850-1000						
851732N	Caterpillar	Minibagger / 200B	216	0	Seltec	TM-08	125	2	12			
851732N	Caterpillar	Minibagger / 200B	226	0	Seltec	TM-08	125	2	12			
851732N	Caterpillar	Minibagger / 200B	232	0	Seltec	TM-08	125	2	12			
851732N	Caterpillar	Minibagger / 200B	242	0	Seltec	TM-08	125	2	12			
851736N	Caterpillar	Motorgrader / H	14	0	Sanden	SD7H15HD	138	1	24	GK	16,4	16,4
851725N	Caterpillar	Motorgrader / H	16	0	Sanden	SD7H15	133	8	24			
851725N	Caterpillar	Motorgrader / H	120	0	Sanden	SD7H15	133	8	24			
851736N	Caterpillar	Motorgrader / H	135	0	Sanden	SD7H15HD	138	1	24	GK	16,4	16,4

Dasis Nr.	Hersteller	Modell	Typ	KW	Herstellereinschränkung	Kompressor-ID	Riemenscheiben-Ø [mm]	Rippenanzahl	Spannung [V]	Zylinderkopf-ID (Kompressor)	Einlass-Ø [mm]	Auslass-Ø [mm]
851725N	Caterpillar	Motorgrader / H	140	0	Sanden	SD7H15	133	8	24			
851725N	Caterpillar	Motorgrader / H	143	0	Sanden	SD7H15	133	8	24			
851725N	Caterpillar	Motorgrader / H	163	0	Sanden	SD7H15	133	8	24			
851736N	Caterpillar	Muldenkipper / 700	769	0	Sanden	SD7H15HD	138	1	24	GK	16,4	16,4
851736N	Caterpillar	Muldenkipper / 700	771	0	Sanden	SD7H15HD	138	1	24	GK	16,4	16,4
852841N	Caterpillar	Muldenkipper / 700	772G	0	Sanden	SD7H15HD	133	8	24		12,5	12,5
852841N	Caterpillar	Muldenkipper / 700	773G	0	Sanden	SD7H15HD	133	8	24		12,5	12,5
851736N	Caterpillar	Muldenkipper / 700	775	0	Sanden	SD7H15HD	138	1	24	GK	16,4	16,4
852841N	Caterpillar	Muldenkipper / 700	777G	0	Sanden	SD7H15HD	133	8	24		12,5	12,5
852841N	Caterpillar	Muldenkipper / 700	7745G	0	Sanden	SD7H15HD	133	8	24		12,5	12,5
850897N	Caterpillar	Raupen Dozer / 900	939	0	Sanden	SD7H15HD	138	1	12	GK	18	18
851790N	Caterpillar	Raupen Dozer / 900	951B	0		S6	170	1	24			
851731N	Caterpillar	Raupen Dozer / 900	955	0	Sanden	SD7H15	152	8	24		16,2	16,2
851731N	Caterpillar	Raupen Dozer / 900	963	0	Sanden	SD7H15	152	8	24		16,2	16,2
851790N	Caterpillar	Raupen Dozer / 900	992	0		S6	170	1	24			
851736N	Caterpillar	Raupen Dozer / D	10R	0	Sanden	SD7H15HD	138	1	24	GK	16,4	16,4
851778N	Caterpillar	Raupen Dozer / D	6	0	Delphi	V5	131	1	24			
851736N	Caterpillar	Raupen Dozer / D	9R	0	Sanden	SD7H15HD	138	1	24	GK	16,4	16,4
850897N	Caterpillar	Raupen Schlepper / Challenger	65E	0	Sanden	SD7H15HD	138	1	12	GK	18	18
851736N	Caterpillar	Raupen Schlepper / Challenger	65E	0	Sanden	SD7H15HD	138	1	24	GK	16,4	16,4
850897N	Caterpillar	Raupen Schlepper / Challenger	75E	0	Sanden	SD7H15HD	138	1	12	GK	18	18



Dasis Nr.	Hersteller	Modell	Typ	KW	Herstellereinschränkung	Kompressor-ID	Riemenscheiben-Ø [mm]	Rippenanzahl	Spannung [V]	Zylinderkopf-ID (Kompressor)	Einlass-Ø [mm]	Auslass-Ø [mm]
851736N	Caterpillar	Raupen Schlepper / Challenger	75E	0	Sanden	SD7H15HD	138	1	24	GK	16,4	16,4
850897N	Caterpillar	Raupen Schlepper / Challenger	85E	0	Sanden	SD7H15HD	138	1	12	GK	18	18
851736N	Caterpillar	Raupen Schlepper / Challenger	85E	0	Sanden	SD7H15HD	138	1	24	GK	16,4	16,4
850897N	Caterpillar	Raupen Schlepper / Challenger	95E	0	Sanden	SD7H15HD	138	1	12	GK	18	18
851736N	Caterpillar	Raupen Schlepper / Challenger	95E	0	Sanden	SD7H15HD	138	1	24	GK	16,4	16,4
850897N	Caterpillar	Schaufellader / 900	906	0	Sanden	SD7H15HD	138	1	12	GK	18	18
850897N	Caterpillar	Schaufellader / 900	908	0	Sanden	SD7H15HD	138	1	12	GK	18	18
851736N	Caterpillar	Schaufellader / 900	910G	0	Sanden	SD7H15HD	138	1	24	GK	16,4	16,4
851736N	Caterpillar	Schaufellader / 900	914G	0	Sanden	SD7H15HD	138	1	24	GK	16,4	16,4
851736N	Caterpillar	Schaufellader / 900	916	0	Sanden	SD7H15HD	138	1	24	GK	16,4	16,4
851790N	Caterpillar	Schaufellader / 900	920	0		S6	170	1	24			
851736N	Caterpillar	Schaufellader / 900	924G	0	Sanden	SD7H15HD	138	1	24	GK	16,4	16,4
851790N	Caterpillar	Schaufellader / 900	950	0		S6	170	1	24			
852841N	Caterpillar	Schaufellader / 900	962K	0	Sanden	SD7H15HD	133	8	24		12,5	12,5
851736N	Caterpillar	Schaufellader / 900	966G	0	Sanden	SD7H15HD	138	1	24	GK	16,4	16,4
851736N	Caterpillar	Schaufellader / 900	972G	0	Sanden	SD7H15HD	138	1	24	GK	16,4	16,4
851721N	Caterpillar	Schaufellader / 900	980H	0	Sanden	SD7H15	133	8	24		16,5	16,5
852841N	Caterpillar	Schaufellader / 900	980K	0	Sanden	SD7H15HD	133	8	24		12,5	12,5
852841N	Caterpillar	Schaufellader / 900	988K	0	Sanden	SD7H15HD	133	8	24		12,5	12,5

Dasis Nr.	Hersteller	Modell	Typ	KW	Herstellereinschränkung	Kompressor-ID	Riemenscheiben-Ø [mm]	Rippenanzahl	Spannung [V]	Zylinderkopf-ID (Kompressor)	Einlass-Ø [mm]	Auslass-Ø [mm]
851731N	Caterpillar	Schaufellader / 900	990H	0	Sanden	SD7H15	152	8	24		16,2	16,2
851729N	Caterpillar	Schaufellader / Challenger	65E	0	Sanden	SD7H15	132	8	12	KCA	13	15
851729N	Caterpillar	Schaufellader / Challenger	75E	0	Sanden	SD7H15	132	8	12	KCA	13	15
851729N	Caterpillar	Schaufellader / Challenger	85E	0	Sanden	SD7H15	132	8	12	KCA	13	15
851729N	Caterpillar	Schaufellader / Challenger	95E	0	Sanden	SD7H15	132	8	12	KCA	13	15
851725N	Caterpillar	Schürfzüge / H	163	0	Sanden	SD7H15	133	8	24			
850856N	Claas	Feldhäcksler / Jaguar	685	0	York	ET206R						
850422N	Claas	Feldhäcksler / Jaguar	685	0	York	R209/210R	ohne Riemenscheibe	ohne Riemenscheibe			13,5	13,5
850856N	Claas	Feldhäcksler / Jaguar	690	0	York	ET206R						
850422N	Claas	Feldhäcksler / Jaguar	690	0	York	R209/210R	ohne Riemenscheibe	ohne Riemenscheibe			13,5	13,5
850856N	Claas	Feldhäcksler / Jaguar	695	0	York	ET206R						
850422N	Claas	Feldhäcksler / Jaguar	695	0	York	R209/210R	ohne Riemenscheibe	ohne Riemenscheibe			13,5	13,5
850877N	Claas	Feldhäcksler / Jaguar	860	0								
858477T	Claas	Feldhäcksler / Jaguar	860	0	York	ET210R						
850423N	Claas	Feldhäcksler / Jaguar	860	0	York	T209/210R					16	16
852924N	Claas	Feldhäcksler / Jaguar	870	0	Denso	10S15C	152	8	12			
850877N	Claas	Feldhäcksler / Jaguar	880	0								
858477T	Claas	Feldhäcksler / Jaguar	880	0	York	ET210R						
850423N	Claas	Feldhäcksler / Jaguar	880	0	York	T209/210R					16	16
852924N	Claas	Feldhäcksler / Jaguar	950	0	Denso	10S15C	152	8	12			
852924N	Claas	Feldhäcksler / Jaguar	960	0	Denso	10S15C	152	8	12			
850876N	Claas	Feldhäcksler / Mega	202	0	Sanden	SD5H14	152	2	12		16	14

Dasis Nr.	Hersteller	Modell	Typ	KW	Herstellereinschränkung	Kompressor-ID	Riemenscheiben-Ø [mm]	Rippenanzahl	Spannung [V]	Zylinderkopf-ID (Kompressor)	Einlass-Ø [mm]	Auslass-Ø [mm]
850876N	Claas	Feldhäcksler / Mega	203	0	Sanden	SD5H14	152	2	12		16	14
850876N	Claas	Feldhäcksler / Mega	204	0	Sanden	SD5H14	152	2	12		16	14
850876N	Claas	Feldhäcksler / Mega	208	0	Sanden	SD5H14	152	2	12		16	14
850876N	Claas	Feldhäcksler / Mega	218	0	Sanden	SD5H14	152	2	12		16	14
850897N	Claas	Mähdrescher / Challenger	65	0	Sanden	SD7H15HD	138	1	12	GK	18	18
850897N	Claas	Mähdrescher / Challenger	75	0	Sanden	SD7H15HD	138	1	12	GK	18	18
850897N	Claas	Mähdrescher / Challenger	85	0	Sanden	SD7H15HD	138	1	12	GK	18	18
850897N	Claas	Mähdrescher / Challenger	95E	0	Sanden	SD7H15HD	138	1	12	GK	18	18
850422N	Claas	Mähdrescher / Dominator 6	56	0	York	R209/210R	ohne Riemenscheibe	ohne Riemenscheibe			13,5	13,5
850422N	Claas	Mähdrescher / Dominator 6	66	0	York	R209/210R	ohne Riemenscheibe	ohne Riemenscheibe			13,5	13,5
850422N	Claas	Mähdrescher / Dominator 6	76	0	York	R209/210R	ohne Riemenscheibe	ohne Riemenscheibe			13,5	13,5
850422N	Claas	Mähdrescher / Dominator 6	86	0	York	R209/210R	ohne Riemenscheibe	ohne Riemenscheibe			13,5	13,5
850422N	Claas	Mähdrescher / Dominator 6	96	0	York	R209/210R	ohne Riemenscheibe	ohne Riemenscheibe			13,5	13,5
850422N	Claas	Mähdrescher / Dominator 6	106	0	York	R209/210R	ohne Riemenscheibe	ohne Riemenscheibe			13,5	13,5
850422N	Claas	Mähdrescher / Dominator 6	116	0	York	R209/210R	ohne Riemenscheibe	ohne Riemenscheibe			13,5	13,5
851746N	Claas	Mähdrescher / Dominator 8	98	0	Sanden	SD508	152	2	12	M	20,5	20,5
850856N	Claas	Mähdrescher / Dominator 8	98	0	York	ET206R						
850422N	Claas	Mähdrescher / Dominator 8	98	0	York	R209/210R	ohne Riemenscheibe	ohne Riemenscheibe			13,5	13,5
850877N	Claas	Mähdrescher / Lexion	410	0								
858477T	Claas	Mähdrescher / Lexion	410	0	York	ET210R						
850423N	Claas	Mähdrescher / Lexion	410	0	York	T209/210R					16	16

Dasis Nr.	Hersteller	Modell	Typ	KW	Herstellereinschränkung	Kompressor-ID	Riemenscheiben-Ø [mm]	Rippenanzahl	Spannung [V]	Zylinderkopf-ID (Kompressor)	Einlass-Ø [mm]	Auslass-Ø [mm]
850877N	Claas	Mähdrescher / Lexion	420	0								
858477T	Claas	Mähdrescher / Lexion	420	0	York	ET210R						
850423N	Claas	Mähdrescher / Lexion	420	0	York	T209/210R					16	16
850877N	Claas	Mähdrescher / Lexion	430	0								
858477T	Claas	Mähdrescher / Lexion	430	0	York	ET210R						
850423N	Claas	Mähdrescher / Lexion	430	0	York	T209/210R					16	16
850877N	Claas	Mähdrescher / Lexion	450	0								
858477T	Claas	Mähdrescher / Lexion	450	0	York	ET210R						
850423N	Claas	Mähdrescher / Lexion	450	0	York	T209/210R					16	16
850877N	Claas	Mähdrescher / Lexion	460	0								
858477T	Claas	Mähdrescher / Lexion	460	0	York	ET210R						
850423N	Claas	Mähdrescher / Lexion	460	0	York	T209/210R					16	16
850877N	Claas	Mähdrescher / Lexion	480	0								
858477T	Claas	Mähdrescher / Lexion	480	0	York	ET210R						
850423N	Claas	Mähdrescher / Lexion	480	0	York	T209/210R					16	16
852649N	Claas	Mähdrescher / Lexion	580	0	Denso	7SBU16C	130	9	12		13	27
853135N	Claas	Mähdrescher / Lexion	620	0	Sanden	SD7H15SHD	152	8	12		11	16
853135N	Claas	Mähdrescher / Lexion	630	0	Sanden	SD7H15SHD	152	8	12		11	16
852924N	Claas	Mähdrescher / Lexion	770	0	Denso	10S15C	152	8	12			
852924N	Claas	Mähdrescher / Lexion	780	0	Denso	10S15C	152	8	12			
850856N	Claas	Mähdrescher / Mega	202	0	York	ET206R						

Dasis Nr.	Hersteller	Modell	Typ	KW	Herstellereinschränkung	Kompressor-ID	Riemenscheiben-Ø [mm]	Rippenanzahl	Spannung [V]	Zylinderkopf-ID (Kompressor)	Einlass-Ø [mm]	Auslass-Ø [mm]
850856N	Claas	Mähdrescher / Mega	203	0	York	ET206R						
850856N	Claas	Mähdrescher / Mega	204	0	York	ET206R						
850856N	Claas	Mähdrescher / Mega	208	0	York	ET206R						
850856N	Claas	Mähdrescher / Mega	218	0	York	ET206R						
850878N	Claas	Raupen Dozer / Challenger	35	0	Sanden	SD7H15HD	138	1	12	KC		
850878N	Claas	Raupen Dozer / Challenger	45	0	Sanden	SD7H15HD	138	1	12	KC		
850878N	Claas	Raupen Dozer / Challenger	55	0	Sanden	SD7H15HD	138	1	12	KC		
851729N	Claas	Raupen Dozer / Xerion	3000	0	Sanden	SD7H15	132	8	12	KCA	13	15
851729N	Claas	Raupen Dozer / Xerion	3300	0	Sanden	SD7H15	132	8	12	KCA	13	15
850340N	Claas	Schlepper / Ares 500	547	0	Denso	10PA15C	125	8	12			
850340N	Claas	Schlepper / Ares 500	557	0	Denso	10PA15C	125	8	12			
850340N	Claas	Schlepper / Ares 500	567	0	Denso	10PA15C	125	8	12			
850340N	Claas	Schlepper / Ares 500	577	0	Denso	10PA15C	125	8	12			
850340N	Claas	Schlepper / Ares 600	617	0	Denso	10PA15C	125	8	12			
850340N	Claas	Schlepper / Ares 600	657	0	Denso	10PA15C	125	8	12			
850340N	Claas	Schlepper / Ares 600	697	0	Denso	10PA15C	125	8	12			
850340N	Claas	Schlepper / Ares 800	816	0	Denso	10PA15C	125	8	12			
850340N	Claas	Schlepper / Ares 800	826	0	Denso	10PA15C	125	8	12			
850340N	Claas	Schlepper / Ares 800	836	0	Denso	10PA15C	125	8	12			
853133N	Claas	Schlepper / Arion 400 Serie	410	0	Denso	10S15C	120	4	12		15	18
853133N	Claas	Schlepper / Arion 400 Serie	420	0	Denso	10S15C	120	4	12		15	18

Dasis Nr.	Hersteller	Modell	Typ	KW	Herstellereinschränkung	Kompressor-ID	Riemenscheiben-Ø [mm]	Rippenanzahl	Spannung [V]	Zylinderkopf-ID (Kompressor)	Einlass-Ø [mm]	Auslass-Ø [mm]
853133N	Claas	Schlepper / Arion 400 Serie	430	0	Denso	10S15C	120	4	12		15	18
853133N	Claas	Schlepper / Arion 400 Serie	440	0	Denso	10S15C	120	4	12		15	18
853133N	Claas	Schlepper / Arion 400 Serie	450	0	Denso	10S15C	120	4	12		15	18
853133N	Claas	Schlepper / Arion 400 Serie	460	0	Denso	10S15C	120	4	12		15	18
853132N	Claas	Schlepper / Arion 500 Serie	530	98	Denso	10S15C	120	4	12		15	18
853132N	Claas	Schlepper / Arion 500 Serie	540	96	Denso	10S15C	120	4	12		15	18
853132N	Claas	Schlepper / Arion 500 Serie	550	0	Denso	10S15C	120	4	12		15	18
853132N	Claas	Schlepper / Arion 600 Serie	620	103	Denso	10S15C	120	4	12		15	18
853132N	Claas	Schlepper / Arion 600 Serie	630	114	Denso	10S15C	120	4	12		15	18
853132N	Claas	Schlepper / Arion 600 Serie	640	129	Denso	10S15C	120	4	12		15	18
853132N	Claas	Schlepper / Arion 600 Serie	650	0	Denso	10S15C	120	4	12		15	18
850340N	Claas	Schlepper / Atlas	926	0	Denso	10PA15C	125	8	12			
850340N	Claas	Schlepper / Atlas	936	0	Denso	10PA15C	125	8	12			
853134N	Claas	Schlepper / Axion 800 Serie	800	0	Denso	10S15C	144	8	12		14	16
853134N	Claas	Schlepper / Axion 800 Serie	820	0	Denso	10S15C	144	8	12		14	16
853134N	Claas	Schlepper / Axion 800 Serie	830	0	Denso	10S15C	144	8	12		14	16
853134N	Claas	Schlepper / Axion 800 Serie	840	0	Denso	10S15C	144	8	12		14	16
853134N	Claas	Schlepper / Axion 800 Serie	850	0	Denso	10S15C	144	8	12		14	16
853134N	Claas	Schlepper / Axion 800 Serie	870	0	Denso	10S15C	144	8	12		14	16
853134N	Claas	Schlepper / Axion 800 Serie	880	0	Denso	10S15C	144	8	12		14	16
850875N	Claas	Schlepper / Celtis	426	0	Sanden	SD7H15	132	2	12	KG		
850875N	Claas	Schlepper / Celtis	436	0	Sanden	SD7H15	132	2	12	KG		
850875N	Claas	Schlepper / Celtis	446	0	Sanden	SD7H15	132	2	12	KG		

Dasis Nr.	Hersteller	Modell	Typ	KW	Herstellereinschränkung	Kompressor-ID	Riemenscheiben-Ø [mm]	Rippenanzahl	Spannung [V]	Zylinderkopf-ID (Kompressor)	Einlass-Ø [mm]	Auslass-Ø [mm]
850340N	Claas	Schlepper / Celtis	456	0	Denso	10PA15C	125	8	12			
850497N	Claas	Targo	40	0	Seltec	TM-15HD	135	2	12		18	15,4
850497N	Claas	Targo	50	0	Seltec	TM-15HD	135	2	12		18	15,4
850497N	Claas	Targo	K50	0	Seltec	TM-15HD	135	2	12		18	15,4
850497N	Claas	Targo	K60	0	Seltec	TM-15HD	135	2	12		18	15,4
850497N	Claas	Targo	K70	0	Seltec	TM-15HD	135	2	12		18	15,4
851406N	Claas	Teleskoplader	Maxi Swather	0	Sanden	SD7H15	132	2	12			
851406N	Claas	Teleskoplader / Ranger	920	0	Sanden	SD7H15	132	2	12			
850883N	Claas	Teleskoplader / Ranger	920	0	Sanden	SD510	140	2	12	QC	16,4	16,4
850626N	Claas	Teleskoplader / Ranger	925	0	Sanden	SD7H15	120	10	24	VE	17,8	11,8
851406N	Claas	Teleskoplader / Ranger	925	0	Sanden	SD7H15	132	2	12			
850883N	Claas	Teleskoplader / Ranger	925	0	Sanden	SD510	140	2	12	QC	16,4	16,4
850626N	Claas	Teleskoplader / Ranger	928	0	Sanden	SD7H15	120	10	24	VE	17,8	11,8
851406N	Claas	Teleskoplader / Ranger	928	0	Sanden	SD7H15	132	2	12			
850883N	Claas	Teleskoplader / Ranger	928	0	Sanden	SD510	140	2	12	QC	16,4	16,4
850626N	Claas	Teleskoplader / Ranger	964	0	Sanden	SD7H15	120	10	24	VE	17,8	11,8
851406N	Claas	Teleskoplader / Ranger	964	0	Sanden	SD7H15	132	2	12			
850883N	Claas	Teleskoplader / Ranger	964	0	Sanden	SD510	140	2	12	QC	16,4	16,4
850626N	Claas	Teleskoplader / Ranger	965	0	Sanden	SD7H15	120	10	24	VE	17,8	11,8
851406N	Claas	Teleskoplader / Ranger	965	0	Sanden	SD7H15	132	2	12			
850883N	Claas	Teleskoplader / Ranger	965	0	Sanden	SD510	140	2	12	QC	16,4	16,4
850626N	Claas	Teleskoplader / Ranger	974	0	Sanden	SD7H15	120	10	24	VE	17,8	11,8
851406N	Claas	Teleskoplader / Ranger	974	0	Sanden	SD7H15	132	2	12			
850883N	Claas	Teleskoplader / Ranger	974	0	Sanden	SD510	140	2	12	QC	16,4	16,4

Dasis Nr.	Hersteller	Modell	Typ	KW	Herstellereinschränkung	Kompressor-ID	Riemenscheiben-Ø [mm]	Rippenanzahl	Spannung [V]	Zylinderkopf-ID (Kompressor)	Einlass-Ø [mm]	Auslass-Ø [mm]
850626N	Claas	Teleskoplader / Ranger	975	0	Sanden	SD7H15	120	10	24	VE	17,8	11,8
851406N	Claas	Teleskoplader / Ranger	975	0	Sanden	SD7H15	132	2	12			
850883N	Claas	Teleskoplader / Ranger	975	0	Sanden	SD510	140	2	12	QC	16,4	16,4
850875N	Deutz	Mähdrescher / Agrovector	266	0	Sanden	SD7H15	132	2	12	KG		
850875N	Deutz	Mähdrescher / Agrovector	307	0	Sanden	SD7H15	132	2	12	KG		
850456N	Deutz	Schlepper / 4000	4065	0	Sanden	SD508	132	2	12			
850456N	Deutz	Schlepper / 4000	4075	0	Sanden	SD508	132	2	12			
850456N	Deutz	Schlepper / 4000	4080	0	Sanden	SD508	132	2	12			
850456N	Deutz	Schlepper / 4000	4090	0	Sanden	SD508	132	2	12			
850456N	Deutz	Schlepper / 8000	8500	0	Sanden	SD508	132	2	12			
850456N	Deutz	Schlepper / 8000	8600	0	Sanden	SD508	132	2	12			
850456N	Deutz	Schlepper / 9000	9800	0	Sanden	SD508	132	2	12			
850892N	Deutz	Schlepper / Agropius mk1	60Plus	0	Sanden	7H15	132	2	12	MJ	15	15
850892N	Deutz	Schlepper / Agropius mk1	70Plus	0	Sanden	7H15	132	2	12	MJ	15	15
850892N	Deutz	Schlepper / Agropius mk1	80Plus	0	Sanden	7H15	132	2	12	MJ	15	15
850892N	Deutz	Schlepper / Agropius mk2	75Plus	0	Sanden	7H15	132	2	12	MJ	15	15
850892N	Deutz	Schlepper / Agropius mk2	85Plus	0	Sanden	7H15	132	2	12	MJ	15	15
850892N	Deutz	Schlepper / Agropius mk2	95Plus	0	Sanden	7H15	132	2	12	MJ	15	15
850892N	Deutz	Schlepper / Agropius mk2	100Plus	0	Sanden	7H15	132	2	12	MJ	15	15
850893N	Deutz	Schlepper / AgroPrima DX	4.31	0	Sanden	SD508	152	2	12	B	19,1	22,2
850893N	Deutz	Schlepper / AgroPrima DX	4.51	0	Sanden	SD508	152	2	12	B	19,1	22,2
850893N	Deutz	Schlepper / AgroPrima DX	4.56	0	Sanden	SD508	152	2	12	B	19,1	22,2
850893N	Deutz	Schlepper / AgroPrima DX	6.06	0	Sanden	SD508	152	2	12	B	19,1	22,2
850893N	Deutz	Schlepper / AgroPrima DX	6.16	0	Sanden	SD508	152	2	12	B	19,1	22,2



Dasis Nr.	Hersteller	Modell	Typ	KW	Herstellereinschränkung	Kompressor-ID	Riemenscheiben-Ø [mm]	Rippenanzahl	Spannung [V]	Zylinderkopf-ID (Kompressor)	Einlass-Ø [mm]	Auslass-Ø [mm]
858020N	Deutz	Schlepper / AgroStar	4.61	0	Sanden	SD7H15HD	132	2	12	JD	13	16
858020N	Deutz	Schlepper / AgroStar	4.71	0	Sanden	SD7H15HD	132	2	12	JD	13	16
858020N	Deutz	Schlepper / AgroStar	6.11	0	Sanden	SD7H15HD	132	2	12	JD	13	16
858020N	Deutz	Schlepper / AgroStar	6.21	0	Sanden	SD7H15HD	132	2	12	JD	13	16
858020N	Deutz	Schlepper / AgroStar	6.31	0	Sanden	SD7H15HD	132	2	12	JD	13	16
858020N	Deutz	Schlepper / AgroStar	6.61	0	Sanden	SD7H15HD	132	2	12	JD	13	16
850456N	Deutz	Schlepper / AgroStar	8360	0	Sanden	SD508	132	2	12			
850456N	Deutz	Schlepper / AgroStar	8425	0	Sanden	SD508	132	2	12			
850893N	Deutz	Schlepper / AgroStar Freisicht S.	4.68	0	Sanden	SD508	152	2	12	B	19,1	22,2
850893N	Deutz	Schlepper / AgroStar Freisicht S.	4.78	0	Sanden	SD508	152	2	12	B	19,1	22,2
850893N	Deutz	Schlepper / AgroStar Freisicht S.	6.08	0	Sanden	SD508	152	2	12	B	19,1	22,2
850893N	Deutz	Schlepper / AgroStar Freisicht S.	6.28	0	Sanden	SD508	152	2	12	B	19,1	22,2
850893N	Deutz	Schlepper / AgroStar Freisicht S.	6.38	0	Sanden	SD508	152	2	12	B	19,1	22,2
850893N	Deutz	Schlepper / AgroStar TG	6.71	0	Sanden	SD508	152	2	12	B	19,1	22,2
850893N	Deutz	Schlepper / AgroStar TG	6.81	0	Sanden	SD508	152	2	12	B	19,1	22,2
851719N	Deutz	Schlepper / Agrottron mk1	4.70	0	Sanden	SD7H15	150	2	12	KG		1
851719N	Deutz	Schlepper / Agrottron mk1	4.80	0	Sanden	SD7H15	150	2	12	KG		1
851719N	Deutz	Schlepper / Agrottron mk1	4.85	0	Sanden	SD7H15	150	2	12	KG		1
851719N	Deutz	Schlepper / Agrottron mk1	4.90	0	Sanden	SD7H15	150	2	12	KG		1

Dasis Nr.	Hersteller	Modell	Typ	KW	Herstellereinschränkung	Kompressor-ID	Riemenscheiben-Ø [mm]	Rippenanzahl	Spannung [V]	Zylinderkopf-ID (Kompressor)	Einlass-Ø [mm]	Auslass-Ø [mm]
851719N	Deutz	Schlepper / Agrottron mk1	4.95	0	Sanden	SD7H15	150	2	12	KG		1
851719N	Deutz	Schlepper / Agrottron mk1	6.00	0	Sanden	SD7H15	150	2	12	KG		1
851719N	Deutz	Schlepper / Agrottron mk1	6.01	0	Sanden	SD7H15	150	2	12	KG		1
851719N	Deutz	Schlepper / Agrottron mk1	6.05	0	Sanden	SD7H15	150	2	12	KG		1
851719N	Deutz	Schlepper / Agrottron mk1	6.15	0	Sanden	SD7H15	150	2	12	KG		1
851719N	Deutz	Schlepper / Agrottron mk1	6.20	0	Sanden	SD7H15	150	2	12	KG		1
851719N	Deutz	Schlepper / Agrottron mk1	6.30	0	Sanden	SD7H15	150	2	12	KG		1
851719N	Deutz	Schlepper / Agrottron mk1	6.45	0	Sanden	SD7H15	150	2	12	KG		1
851719N	Deutz	Schlepper / Agrottron mk2	80	0	Sanden	SD7H15	150	2	12	KG		1
851719N	Deutz	Schlepper / Agrottron mk2	85	0	Sanden	SD7H15	150	2	12	KG		1
851719N	Deutz	Schlepper / Agrottron mk2	90	0	Sanden	SD7H15	150	2	12	KG		1
851719N	Deutz	Schlepper / Agrottron mk2	100	0	Sanden	SD7H15	150	2	12	KG		1
851719N	Deutz	Schlepper / Agrottron mk2	105	0	Sanden	SD7H15	150	2	12	KG		1
851719N	Deutz	Schlepper / Agrottron mk2	106	0	Sanden	SD7H15	150	2	12	KG		1
851719N	Deutz	Schlepper / Agrottron mk2	110	0	Sanden	SD7H15	150	2	12	KG		1
851719N	Deutz	Schlepper / Agrottron mk2	115	0	Sanden	SD7H15	150	2	12	KG		1
851719N	Deutz	Schlepper / Agrottron mk2	120	0	Sanden	SD7H15	150	2	12	KG		1
851719N	Deutz	Schlepper / Agrottron mk2	135	0	Sanden	SD7H15	150	2	12	KG		1
851719N	Deutz	Schlepper / Agrottron mk2	150	0	Sanden	SD7H15	150	2	12	KG		1
851719N	Deutz	Schlepper / Agrottron mk2	160	0	Sanden	SD7H15	150	2	12	KG		1
851719N	Deutz	Schlepper / Agrottron mk2	175	0	Sanden	SD7H15	150	2	12	KG		1

Dasis Nr.	Hersteller	Modell	Typ	KW	Herstellereinschränkung	Kompressor-ID	Riemenscheiben-Ø [mm]	Rippenanzahl	Spannung [V]	Zylinderkopf-ID (Kompressor)	Einlass-Ø [mm]	Auslass-Ø [mm]
851719N	Deutz	Schlepper / Agrottron mk2	200	0	Sanden	SD7H15	150	2	12	KG		1
850875N	Deutz	Schlepper / Agrottron mk2	230	0	Sanden	SD7H15	132	2	12	KG		
850875N	Deutz	Schlepper / Agrottron mk2	260	0	Sanden	SD7H15	132	2	12	KG		
851719N	Deutz	Schlepper / Agrottron mk3	80	0	Sanden	SD7H15	150	2	12	KG		1
851719N	Deutz	Schlepper / Agrottron mk3	85	0	Sanden	SD7H15	150	2	12	KG		1
851719N	Deutz	Schlepper / Agrottron mk3	90	0	Sanden	SD7H15	150	2	12	KG		1
851719N	Deutz	Schlepper / Agrottron mk3	100	0	Sanden	SD7H15	150	2	12	KG		1
851719N	Deutz	Schlepper / Agrottron mk3	105	0	Sanden	SD7H15	150	2	12	KG		1
851719N	Deutz	Schlepper / Agrottron mk3	106	0	Sanden	SD7H15	150	2	12	KG		1
851719N	Deutz	Schlepper / Agrottron mk3	110	0	Sanden	SD7H15	150	2	12	KG		1
851719N	Deutz	Schlepper / Agrottron mk3	115	0	Sanden	SD7H15	150	2	12	KG		1
851719N	Deutz	Schlepper / Agrottron mk3	120	0	Sanden	SD7H15	150	2	12	KG		1
851719N	Deutz	Schlepper / Agrottron mk3	135	0	Sanden	SD7H15	150	2	12	KG		1
851719N	Deutz	Schlepper / Agrottron mk3	150	0	Sanden	SD7H15	150	2	12	KG		1
851719N	Deutz	Schlepper / Agrottron mk3	160	0	Sanden	SD7H15	150	2	12	KG		1
851719N	Deutz	Schlepper / Agrottron mk3	175	0	Sanden	SD7H15	150	2	12	KG		1
851719N	Deutz	Schlepper / Agrottron mk3	200	0	Sanden	SD7H15	150	2	12	KG		1
850875N	Deutz	Schlepper / Agrottron mk3	230	0	Sanden	SD7H15	132	2	12	KG		
850875N	Deutz	Schlepper / Agrottron mk3	260	0	Sanden	SD7H15	132	2	12	KG		
850893N	Deutz	Schlepper / AgroXtra	3.57	0	Sanden	SD508	152	2	12	B	19,1	22,2
850893N	Deutz	Schlepper / AgroXtra	4.07	0	Sanden	SD508	152	2	12	B	19,1	22,2

Dasis Nr.	Hersteller	Modell	Typ	KW	Herstellereinschränkung	Kompressor-ID	Riemenscheiben-Ø [mm]	Rippenanzahl	Spannung [V]	Zylinderkopf-ID (Kompressor)	Einlass-Ø [mm]	Auslass-Ø [mm]
850893N	Deutz	Schlepper / AgroXtra	4.17	0	Sanden	SD508	152	2	12	B	19,1	22,2
850893N	Deutz	Schlepper / AgroXtra	4.47	0	Sanden	SD508	152	2	12	B	19,1	22,2
850893N	Deutz	Schlepper / AgroXtra	4.57	0	Sanden	SD508	152	2	12	B	19,1	22,2
850893N	Deutz	Schlepper / AgroXtra	6.07	0	Sanden	SD508	152	2	12	B	19,1	22,2
850893N	Deutz	Schlepper / AgroXtra	6.17	0	Sanden	SD508	152	2	12	B	19,1	22,2
850893N	Deutz	Schlepper / DO7	2807	0	Sanden	SD508	152	2	12	B	19,1	22,2
850893N	Deutz	Schlepper / DO7	3607	0	Sanden	SD508	152	2	12	B	19,1	22,2
850893N	Deutz	Schlepper / DO7	4007	0	Sanden	SD508	152	2	12	B	19,1	22,2
850893N	Deutz	Schlepper / DO7	4507	0	Sanden	SD508	152	2	12	B	19,1	22,2
850893N	Deutz	Schlepper / DO7	4807	0	Sanden	SD508	152	2	12	B	19,1	22,2
850893N	Deutz	Schlepper / DO7	5207	0	Sanden	SD508	152	2	12	B	19,1	22,2
850893N	Deutz	Schlepper / DO7	6007	0	Sanden	SD508	152	2	12	B	19,1	22,2
850893N	Deutz	Schlepper / DO7	6207	0	Sanden	SD508	152	2	12	B	19,1	22,2
850893N	Deutz	Schlepper / DO7	6507	0	Sanden	SD508	152	2	12	B	19,1	22,2
850893N	Deutz	Schlepper / DO7	6807	0	Sanden	SD508	152	2	12	B	19,1	22,2
850893N	Deutz	Schlepper / DO7	6907	0	Sanden	SD508	152	2	12	B	19,1	22,2
850893N	Deutz	Schlepper / DO7	7007	0	Sanden	SD508	152	2	12	B	19,1	22,2
850893N	Deutz	Schlepper / DO7	7207	0	Sanden	SD508	152	2	12	B	19,1	22,2
850893N	Deutz	Schlepper / DO7	7807	0	Sanden	SD508	152	2	12	B	19,1	22,2
850893N	Deutz	Schlepper / DO7C	4507	0	Sanden	SD508	152	2	12	B	19,1	22,2
850893N	Deutz	Schlepper / DO7C	4807	0	Sanden	SD508	152	2	12	B	19,1	22,2
850893N	Deutz	Schlepper / DO7C	5207	0	Sanden	SD508	152	2	12	B	19,1	22,2
850893N	Deutz	Schlepper / DO7C	6007	0	Sanden	SD508	152	2	12	B	19,1	22,2
850893N	Deutz	Schlepper / DO7C	6207	0	Sanden	SD508	152	2	12	B	19,1	22,2
850893N	Deutz	Schlepper / DO7C	6507	0	Sanden	SD508	152	2	12	B	19,1	22,2
850893N	Deutz	Schlepper / DO7C	6807	0	Sanden	SD508	152	2	12	B	19,1	22,2

Dasis Nr.	Hersteller	Modell	Typ	KW	Herstellereinschränkung	Kompressor-ID	Riemenscheiben-Ø [mm]	Rippenanzahl	Spannung [V]	Zylinderkopf-ID (Kompressor)	Einlass-Ø [mm]	Auslass-Ø [mm]
850893N	Deutz	Schlepper / DO7C	6907	0	Sanden	SD508	152	2	12	B	19,1	22,2
850893N	Deutz	Schlepper / DO7C	7007	0	Sanden	SD508	152	2	12	B	19,1	22,2
850893N	Deutz	Schlepper / DO7C	7207	0	Sanden	SD508	152	2	12	B	19,1	22,2
850893N	Deutz	Schlepper / DO7C	7807	0	Sanden	SD508	152	2	12	B	19,1	22,2
850893N	Deutz	Schlepper / DX	80	0	Sanden	SD508	152	2	12	B	19,1	22,2
850893N	Deutz	Schlepper / DX	85	0	Sanden	SD508	152	2	12	B	19,1	22,2
858454N	Deutz	Schlepper / DX	85	0	Sanden	SD510	132	2	12	M	14	13
850893N	Deutz	Schlepper / DX	86	0	Sanden	SD508	152	2	12	B	19,1	22,2
850893N	Deutz	Schlepper / DX	90	0	Sanden	SD508	152	2	12	B	19,1	22,2
858454N	Deutz	Schlepper / DX	90	0	Sanden	SD510	132	2	12	M	14	13
850893N	Deutz	Schlepper / DX	92	0	Sanden	SD508	152	2	12	B	19,1	22,2
858454N	Deutz	Schlepper / DX	92	0	Sanden	SD510	132	2	12	M	14	13
850893N	Deutz	Schlepper / DX	110	0	Sanden	SD508	152	2	12	B	19,1	22,2
858454N	Deutz	Schlepper / DX	110	0	Sanden	SD510	132	2	12	M	14	13
850893N	Deutz	Schlepper / DX	120	0	Sanden	SD508	152	2	12	B	19,1	22,2
858454N	Deutz	Schlepper / DX	120	0	Sanden	SD510	132	2	12	M	14	13
858454N	Deutz	Schlepper / DX	140	0	Sanden	SD510	132	2	12	M	14	13
850893N	Deutz	Schlepper / DX	145	0	Sanden	SD508	152	2	12	B	19,1	22,2
858454N	Deutz	Schlepper / DX	145	0	Sanden	SD510	132	2	12	M	14	13
850893N	Deutz	Schlepper / DX	160	0	Sanden	SD508	152	2	12	B	19,1	22,2
858454N	Deutz	Schlepper / DX	160	0	Sanden	SD510	132	2	12	M	14	13
850893N	Deutz	Schlepper / DX	250	0	Sanden	SD508	152	2	12	B	19,1	22,2
850893N	Deutz	Schlepper / DX3	3.10	0	Sanden	SD508	152	2	12	B	19,1	22,2
850893N	Deutz	Schlepper / DX3	3.30	0	Sanden	SD508	152	2	12	B	19,1	22,2
850893N	Deutz	Schlepper / DX3	3.50	0	Sanden	SD508	152	2	12	B	19,1	22,2
850893N	Deutz	Schlepper / DX3	3.60	0	Sanden	SD508	152	2	12	B	19,1	22,2
850893N	Deutz	Schlepper / DX3	3.65	0	Sanden	SD508	152	2	12	B	19,1	22,2
850893N	Deutz	Schlepper / DX3	3.70	0	Sanden	SD508	152	2	12	B	19,1	22,2
850893N	Deutz	Schlepper / DX3	3.80	0	Sanden	SD508	152	2	12	B	19,1	22,2
850893N	Deutz	Schlepper / DX3	3.90	0	Sanden	SD508	152	2	12	B	19,1	22,2

Dasis Nr.	Hersteller	Modell	Typ	KW	Herstellereinschränkung	Kompressor-ID	Riemenscheiben-Ø [mm]	Rippenanzahl	Spannung [V]	Zylinderkopf-ID (Kompressor)	Einlass-Ø [mm]	Auslass-Ø [mm]
850893N	Deutz	Schlepper / DX4	4.10	0	Sanden	SD508	152	2	12	B	19,1	22,2
850893N	Deutz	Schlepper / DX4	4.30	0	Sanden	SD508	152	2	12	B	19,1	22,2
850893N	Deutz	Schlepper / DX4	4.50	0	Sanden	SD508	152	2	12	B	19,1	22,2
850893N	Deutz	Schlepper / DX4	4.70	0	Sanden	SD508	152	2	12	B	19,1	22,2
850893N	Deutz	Schlepper / DX6	6.05	0	Sanden	SD508	152	2	12	B	19,1	22,2
850893N	Deutz	Schlepper / DX6	6.10	0	Sanden	SD508	152	2	12	B	19,1	22,2
850893N	Deutz	Schlepper / DX6	6.30	0	Sanden	SD508	152	2	12	B	19,1	22,2
850893N	Deutz	Schlepper / DX6	6.50	0	Sanden	SD508	152	2	12	B	19,1	22,2
850893N	Deutz	Schlepper / DX7	7.10	0	Sanden	SD508	152	2	12	B	19,1	22,2
851097N	Deutz	Schlepper / DX8	8.30	0	GM Harrison	A6	172	1	12			
851790N	Deutz	Schlepper / DX8	11171	0		S6	170	1	24			
850893N	Deutz	Schlepper / Hopfen	4.17	0	Sanden	SD508	152	2	12	B	19,1	22,2
850893N	Deutz	Schlepper / Hopfen	4.57	0	Sanden	SD508	152	2	12	B	19,1	22,2
850893N	Deutz	Schlepper / Intrac	6.30	0	Sanden	SD508	152	2	12	B	19,1	22,2
850893N	Deutz	Schlepper / Intrac	6.60	0	Sanden	SD508	152	2	12	B	19,1	22,2
850893N	Deutz	Schlepper / Intrac	2002	0	Sanden	SD508	152	2	12	B	19,1	22,2
850893N	Deutz	Schlepper / Intrac	2003	0	Sanden	SD508	152	2	12	B	19,1	22,2
850893N	Deutz	Schlepper / Intrac	2004	0	Sanden	SD508	152	2	12	B	19,1	22,2
850327N	Deutz	Schlepper Wein Obst / Agrocompac	90F	0	Sanden	SD7B10	115	2	12		14,9	12,2
850885N	Fendt	Mähdrescher / 5220- 5275	5220	0	Sanden	SD508	132	2	12	FL	16	14
850885N	Fendt	Mähdrescher / 5220- 5275	5250	0	Sanden	SD508	132	2	12	FL	16	14
850885N	Fendt	Mähdrescher / 6270-6350	6300	0	Sanden	SD508	132	2	12	FL	16	14
850885N	Fendt	Mähdrescher / 6270-6350	6350	0	Sanden	SD508	132	2	12	FL	16	14
850859N	Fendt	Mähdrescher / Farmer 200	275V	0								

Dasis Nr.	Hersteller	Modell	Typ	KW	Herstellereinschränkung	Kompressor-ID	Riemenscheiben-Ø [mm]	Rippenanzahl	Spannung [V]	Zylinderkopf-ID (Kompressor)	Einlass-Ø [mm]	Auslass-Ø [mm]
850859N	Fendt	Mähdrescher / Farmer 200	275VA	0								
850859N	Fendt	Mähdrescher / Farmer 200	280VA	0								
852070N	Fendt	Mähdrescher / Forage / Katana	65	0	Denso	10PA15C	129	9	24		16,1	15,3
851762N	Fendt	Schlepper / Farmer 200	205P	0	Denso	10S15C	132	1	12		18,3	15,5
851762N	Fendt	Schlepper / Farmer 200	205PA	0	Denso	10S15C	132	1	12		18,3	15,5
850859N	Fendt	Schlepper / Farmer 200	206V	0								
850859N	Fendt	Schlepper / Farmer 200	206VA	0								
850859N	Fendt	Schlepper / Farmer 200	207V	0								
850859N	Fendt	Schlepper / Farmer 200	207VA	0								
851762N	Fendt	Schlepper / Farmer 200	208PA	0	Denso	10S15C	132	1	12		18,3	15,5
851762N	Fendt	Schlepper / Farmer 200	209PA	0	Denso	10S15C	132	1	12		18,3	15,5
851762N	Fendt	Schlepper / Farmer 200	209VA	0	Denso	10S15C	132	1	12		18,3	15,5
850859N	Fendt	Schlepper / Farmer 200	250K	0								
850700N	Fendt	Schlepper / Farmer 200	250K	0	Denso	10P15C	140	1	12			
850859N	Fendt	Schlepper / Farmer 200	250KA	0								
850700N	Fendt	Schlepper / Farmer 200	250KA	0	Denso	10P15C	140	1	12			
850859N	Fendt	Schlepper / Farmer 200	250LE	0								
850700N	Fendt	Schlepper / Farmer 200	250LE	0	Denso	10P15C	140	1	12			
850859N	Fendt	Schlepper / Farmer 200	250S	0								
850700N	Fendt	Schlepper / Farmer 200	250S	0	Denso	10P15C	140	1	12			
850859N	Fendt	Schlepper / Farmer 200	250SA	0								

Dasis Nr.	Hersteller	Modell	Typ	KW	Herstellereinschränkung	Kompressor-ID	Riemenscheiben-Ø [mm]	Rippenanzahl	Spannung [V]	Zylinderkopf-ID (Kompressor)	Einlass-Ø [mm]	Auslass-Ø [mm]
850700N	Fendt	Schlepper / Farmer 200	250SA	0	Denso	10P15C	140	1	12			
850859N	Fendt	Schlepper / Farmer 200	250V	0								
850859N	Fendt	Schlepper / Farmer 200	250VA	0								
851762N	Fendt	Schlepper / Farmer 200	260P	0	Denso	10S15C	132	1	12		18,3	15,5
851762N	Fendt	Schlepper / Farmer 200	260PA	0	Denso	10S15C	132	1	12		18,3	15,5
850859N	Fendt	Schlepper / Farmer 200	260S	0								
850700N	Fendt	Schlepper / Farmer 200	260S	0	Denso	10P15C	140	1	12			
850859N	Fendt	Schlepper / Farmer 200	260SA	0								
850700N	Fendt	Schlepper / Farmer 200	260SA	0	Denso	10P15C	140	1	12			
850859N	Fendt	Schlepper / Farmer 200	260V	0								
850859N	Fendt	Schlepper / Farmer 200	260VA	0								
851762N	Fendt	Schlepper / Farmer 200	270P	0	Denso	10S15C	132	1	12		18,3	15,5
851762N	Fendt	Schlepper / Farmer 200	270PA	0	Denso	10S15C	132	1	12		18,3	15,5
850859N	Fendt	Schlepper / Farmer 200	270V	0								
850859N	Fendt	Schlepper / Farmer 200	270VA	0								
850859N	Fendt	Schlepper / Farmer 200	275SA	0								
850700N	Fendt	Schlepper / Farmer 200	275SA	0	Denso	10P15C	140	1	12			
851762N	Fendt	Schlepper / Farmer 200	280P	0	Denso	10S15C	132	1	12		18,3	15,5
851762N	Fendt	Schlepper / Farmer 200	280PA	0	Denso	10S15C	132	1	12		18,3	15,5
850859N	Fendt	Schlepper / Farmer 200	280S	0								
850700N	Fendt	Schlepper / Farmer 200	280S	0	Denso	10P15C	140	1	12			



Dasis Nr.	Hersteller	Modell	Typ	KW	Herstellereinschränkung	Kompressor-ID	Riemenscheiben-Ø [mm]	Rippenanzahl	Spannung [V]	Zylinderkopf-ID (Kompressor)	Einlass-Ø [mm]	Auslass-Ø [mm]
850859N	Fendt	Schlepper / Farmer 200	280SA	0								
850700N	Fendt	Schlepper / Farmer 200	280SA	0	Denso	10P15C	140	1	12			
850700N	Fendt	Schlepper / Farmer 300	303LS	0	Denso	10P15C	140	1	12			
850700N	Fendt	Schlepper / Farmer 300	303LSA	0	Denso	10P15C	140	1	12			
850700N	Fendt	Schlepper / Farmer 300	304LS	0	Denso	10P15C	140	1	12			
850700N	Fendt	Schlepper / Farmer 300	304LSA	0	Denso	10P15C	140	1	12			
850700N	Fendt	Schlepper / Farmer 300	305LS	0	Denso	10P15C	140	1	12			
850700N	Fendt	Schlepper / Farmer 300	305LSA	0	Denso	10P15C	140	1	12			
850700N	Fendt	Schlepper / Farmer 300	306LS	0	Denso	10P15C	140	1	12			
850700N	Fendt	Schlepper / Farmer 300	306LSA	0	Denso	10P15C	140	1	12			
851762N	Fendt	Schlepper / Farmer 300	307	0	Denso	10S15C	132	1	12		18,3	15,5
850859N	Fendt	Schlepper / Farmer 300	307LS	0								
850700N	Fendt	Schlepper / Farmer 300	307LS	0	Denso	10P15C	140	1	12			
851745N	Fendt	Schlepper / Farmer 300	307LS	0	Denso	10PA15C	133	1	12		10,5	14,5
850700N	Fendt	Schlepper / Farmer 300	307LSA	0	Denso	10P15C	140	1	12			
851745N	Fendt	Schlepper / Farmer 300	307LSA	0	Denso	10PA15C	133	1	12		10,5	14,5
851745N	Fendt	Schlepper / Farmer 300	307LSE	0	Denso	10PA15C	133	1	12		10,5	14,5
850700N	Fendt	Schlepper / Farmer 300	308	0	Denso	10P15C	140	1	12			
851745N	Fendt	Schlepper / Farmer 300	308	0	Denso	10PA15C	133	1	12		10,5	14,5
851762N	Fendt	Schlepper / Farmer 300	308	0	Denso	10S15C	132	1	12		18,3	15,5
850700N	Fendt	Schlepper / Farmer 300	308LS	0	Denso	10P15C	140	1	12			

Dasis Nr.	Hersteller	Modell	Typ	KW	Herstellereinschränkung	Kompressor-ID	Riemenscheiben-Ø [mm]	Rippenanzahl	Spannung [V]	Zylinderkopf-ID (Kompressor)	Einlass-Ø [mm]	Auslass-Ø [mm]
851745N	Fendt	Schlepper / Farmer 300	308LS	0	Denso	10PA15C	133	1	12		10,5	14,5
850859N	Fendt	Schlepper / Farmer 300	308LSA	0								
850700N	Fendt	Schlepper / Farmer 300	308LSA	0	Denso	10P15C	140	1	12			
851745N	Fendt	Schlepper / Farmer 300	308LSA	0	Denso	10PA15C	133	1	12		10,5	14,5
850859N	Fendt	Schlepper / Farmer 300	308LSE	0								
850700N	Fendt	Schlepper / Farmer 300	308LSE	0	Denso	10P15C	140	1	12			
851745N	Fendt	Schlepper / Farmer 300	308LSE	0	Denso	10PA15C	133	1	12		10,5	14,5
851762N	Fendt	Schlepper / Farmer 300	309	0	Denso	10S15C	132	1	12		18,3	15,5
850859N	Fendt	Schlepper / Farmer 300	309LS	0								
850700N	Fendt	Schlepper / Farmer 300	309LS	0	Denso	10P15C	140	1	12			
851745N	Fendt	Schlepper / Farmer 300	309LS	0	Denso	10PA15C	133	1	12		10,5	14,5
850859N	Fendt	Schlepper / Farmer 300	309LSA	0								
850700N	Fendt	Schlepper / Farmer 300	309LSA	0	Denso	10P15C	140	1	12			
851745N	Fendt	Schlepper / Farmer 300	309LSA	0	Denso	10PA15C	133	1	12		10,5	14,5
850859N	Fendt	Schlepper / Farmer 300	309LSE	0								
850700N	Fendt	Schlepper / Farmer 300	309LSE	0	Denso	10P15C	140	1	12			
851745N	Fendt	Schlepper / Farmer 300	309LSE	0	Denso	10PA15C	133	1	12		10,5	14,5
850859N	Fendt	Schlepper / Farmer 300	310LSA	0								
850700N	Fendt	Schlepper / Farmer 300	310LSA	0	Denso	10P15C	140	1	12			
851745N	Fendt	Schlepper / Farmer 300	310LSA	0	Denso	10PA15C	133	1	12		10,5	14,5
850859N	Fendt	Schlepper / Farmer 300	310LSE	0								

Dasis Nr.	Hersteller	Modell	Typ	KW	Herstellereinschränkung	Kompressor-ID	Riemenscheiben-Ø [mm]	Rippenanzahl	Spannung [V]	Zylinderkopf-ID (Kompressor)	Einlass-Ø [mm]	Auslass-Ø [mm]
850700N	Fendt	Schlepper / Farmer 300	310LSE	0	Denso	10P15C	140	1	12			
851745N	Fendt	Schlepper / Farmer 300	310LSE	0	Denso	10PA15C	133	1	12		10,5	14,5
850859N	Fendt	Schlepper / Farmer 300	311LSA	0								
850700N	Fendt	Schlepper / Farmer 300	311LSA	0	Denso	10P15C	140	1	12			
851745N	Fendt	Schlepper / Farmer 300	311LSA	0	Denso	10PA15C	133	1	12		10,5	14,5
850859N	Fendt	Schlepper / Farmer 300	311LSE	0								
850700N	Fendt	Schlepper / Farmer 300	311LSE	0	Denso	10P15C	140	1	12			
851745N	Fendt	Schlepper / Farmer 300	311LSE	0	Denso	10PA15C	133	1	12		10,5	14,5
850859N	Fendt	Schlepper / Farmer 300	312LSA	0								
850700N	Fendt	Schlepper / Farmer 300	312LSA	0	Denso	10P15C	140	1	12			
851745N	Fendt	Schlepper / Farmer 300	312LSA	0	Denso	10PA15C	133	1	12		10,5	14,5
850859N	Fendt	Schlepper / Farmer 300	312LSE	0								
850700N	Fendt	Schlepper / Farmer 300	312LSE	0	Denso	10P15C	140	1	12			
851745N	Fendt	Schlepper / Farmer 300	312LSE	0	Denso	10PA15C	133	1	12		10,5	14,5
850859N	Fendt	Schlepper / Farmer 400	409	0								
850859N	Fendt	Schlepper / Farmer 400	410	0								
850859N	Fendt	Schlepper / Farmer 400	411	0								
850859N	Fendt	Schlepper / Farmer 400	412	0								
850859N	Fendt	Schlepper / Favorit 500	509	0								
851745N	Fendt	Schlepper / Favorit 500	509	0	Denso	10PA15C	133	1	12		10,5	14,5
850859N	Fendt	Schlepper / Favorit 500	510	0								

Dasis Nr.	Hersteller	Modell	Typ	KW	Herstellereinschränkung	Kompressor-ID	Riemenscheiben-Ø [mm]	Rippenanzahl	Spannung [V]	Zylinderkopf-ID (Kompressor)	Einlass-Ø [mm]	Auslass-Ø [mm]
851745N	Fendt	Schlepper / Favorit 500	510	0	Denso	10PA15C	133	1	12		10,5	14,5
850859N	Fendt	Schlepper / Favorit 500	511	0								
851745N	Fendt	Schlepper / Favorit 500	511	0	Denso	10PA15C	133	1	12		10,5	14,5
850859N	Fendt	Schlepper / Favorit 500	512	0								
851745N	Fendt	Schlepper / Favorit 500	512	0	Denso	10PA15C	133	1	12		10,5	14,5
850859N	Fendt	Schlepper / Favorit 500	514	0								
851745N	Fendt	Schlepper / Favorit 500	514	0	Denso	10PA15C	133	1	12		10,5	14,5
850859N	Fendt	Schlepper / Favorit 500	515	0								
851745N	Fendt	Schlepper / Favorit 500	515	0	Denso	10PA15C	133	1	12		10,5	14,5
851753N	Fendt	Schlepper / Favorit 600	611LS	0	GM Harrison	A6	139	1	12		16	16
851753N	Fendt	Schlepper / Favorit 600	611LSA	0	GM Harrison	A6	139	1	12		16	16
851753N	Fendt	Schlepper / Favorit 600	611S	0	GM Harrison	A6	139	1	12		16	16
851753N	Fendt	Schlepper / Favorit 600	611SA	0	GM Harrison	A6	139	1	12		16	16
851753N	Fendt	Schlepper / Favorit 600	612LSA	0	GM Harrison	A6	139	1	12		16	16
851753N	Fendt	Schlepper / Favorit 600	612SA	0	GM Harrison	A6	139	1	12		16	16
851753N	Fendt	Schlepper / Favorit 600	614LSA	0	GM Harrison	A6	139	1	12		16	16
851753N	Fendt	Schlepper / Favorit 600	614SA	0	GM Harrison	A6	139	1	12		16	16
851753N	Fendt	Schlepper / Favorit 600	615LSA	0	GM Harrison	A6	139	1	12		16	16
851753N	Fendt	Schlepper / Favorit 600	615SA	0	GM Harrison	A6	139	1	12		16	16
850859N	Fendt	Schlepper / Favorit 700	711	0								
851762N	Fendt	Schlepper / Favorit 700	711	0	Denso	10S15C	132	1	12		18,3	15,5

Dasis Nr.	Hersteller	Modell	Typ	KW	Herstellereinschränkung	Kompressor-ID	Riemenscheiben-Ø [mm]	Rippenanzahl	Spannung [V]	Zylinderkopf-ID (Kompressor)	Einlass-Ø [mm]	Auslass-Ø [mm]
850859N	Fendt	Schlepper / Favorit 700	712	0								
851762N	Fendt	Schlepper / Favorit 700	712	0	Denso	10S15C	132	1	12		18,3	15,5
850859N	Fendt	Schlepper / Favorit 700	714	0								
851762N	Fendt	Schlepper / Favorit 700	714	0	Denso	10S15C	132	1	12		18,3	15,5
850859N	Fendt	Schlepper / Favorit 700	716	0								
851762N	Fendt	Schlepper / Favorit 700	716	0	Denso	10S15C	132	1	12		18,3	15,5
850859N	Fendt	Schlepper / Favorit 800	815	0								
850700N	Fendt	Schlepper / Favorit 800	815	0	Denso	10P15C	140	1	12			
851762N	Fendt	Schlepper / Favorit 800	815	0	Denso	10S15C	132	1	12		18,3	15,5
850859N	Fendt	Schlepper / Favorit 800	816	0								
850700N	Fendt	Schlepper / Favorit 800	816	0	Denso	10P15C	140	1	12			
851762N	Fendt	Schlepper / Favorit 800	816	0	Denso	10S15C	132	1	12		18,3	15,5
850859N	Fendt	Schlepper / Favorit 800	817	0								
850700N	Fendt	Schlepper / Favorit 800	817	0	Denso	10P15C	140	1	12			
851762N	Fendt	Schlepper / Favorit 800	817	0	Denso	10S15C	132	1	12		18,3	15,5
850859N	Fendt	Schlepper / Favorit 800	818	0								
850700N	Fendt	Schlepper / Favorit 800	818	0	Denso	10P15C	140	1	12			
851762N	Fendt	Schlepper / Favorit 800	818	0	Denso	10S15C	132	1	12		18,3	15,5
850859N	Fendt	Schlepper / Favorit 900	916	0								
850859N	Fendt	Schlepper / Favorit 900	918	0								
850859N	Fendt	Schlepper / Favorit 900	920	0								

Dasis Nr.	Hersteller	Modell	Typ	KW	Herstellereinschränkung	Kompressor-ID	Riemenscheiben-Ø [mm]	Rippenanzahl	Spannung [V]	Zylinderkopf-ID (Kompressor)	Einlass-Ø [mm]	Auslass-Ø [mm]
850859N	Fendt	Schlepper / Favorit 900	924	0								
850859N	Fendt	Schlepper / Favorit 900	926	0								
850859N	Fendt	Schlepper / Favorit 900	926PL	0								
851762N	Fendt	Schlepper / Favorit 900	930	0	Denso	10S15C	132	1	12		18,3	15,5
850859N	Fendt	Schlepper / GT300	370	0								
850859N	Fendt	Schlepper / GT300	380	0								
851745N	Fendt	Schlepper / GT300	390	0	Denso	10PA15C	133	1	12		10,5	14,5
851745N	Fendt	Schlepper / GT300	395	0	Denso	10PA15C	133	1	12		10,5	14,5
850859N	Fendt	Schlepper / GT300	A370	0								
850859N	Fendt	Schlepper / GT300	A380	0								
851745N	Fendt	Schlepper / GT300	A390	0	Denso	10PA15C	133	1	12		10,5	14,5
851745N	Fendt	Schlepper / GT300	A395	0	Denso	10PA15C	133	1	12		10,5	14,5
853136N	Fendt	Schlepper / MT	1149MT	0	Sanden	SD7H15	137	8	12			
853136N	Fendt	Schlepper / MT	1154MT	0	Sanden	SD7H15	137	8	12			
853136N	Fendt	Schlepper / MT	1159MT	0	Sanden	SD7H15	137	8	12			
853136N	Fendt	Schlepper / MT	1165MT	0	Sanden	SD7H15	137	8	12			
852916N	Fendt	Schlepper / Vario	309	0	Denso	10S17C	133	1	12		15	18
852916N	Fendt	Schlepper / Vario	310	0	Denso	10S17C	133	1	12		15	18
852916N	Fendt	Schlepper / Vario	311	0	Denso	10S17C	133	1	12		15	18
852916N	Fendt	Schlepper / Vario	312	0	Denso	10S17C	133	1	12		15	18
852916N	Fendt	Schlepper / Vario	313	0	Denso	10S17C	133	1	12		15	18
852916N	Fendt	Schlepper / Vario	720	0	Denso	10S17C	133	1	12		15	18
852916N	Fendt	Schlepper / Vario	722	0	Denso	10S17C	133	1	12		15	18
852916N	Fendt	Schlepper / Vario	724	0	Denso	10S17C	133	1	12		15	18
853136N	Fendt	Schlepper / Vario 900 MT	938	0	Sanden	SD7H15	137	8	12			

Dasis Nr.	Hersteller	Modell	Typ	KW	Herstellereinschränkung	Kompressor-ID	Riemenscheiben-Ø [mm]	Rippenanzahl	Spannung [V]	Zylinderkopf-ID (Kompressor)	Einlass-Ø [mm]	Auslass-Ø [mm]
853136N	Fendt	Schlepper / Vario 900 MT	940	0	Sanden	SD7H15	137	8	12			
853136N	Fendt	Schlepper / Vario 900 MT	943	0	Sanden	SD7H15	137	8	12			
850859N	Fendt	Schlepper / Xylon	520	0								
850859N	Fendt	Schlepper / Xylon	522	0								
850859N	Fendt	Schlepper / Xylon	524	0								
850889N	Fiat / Hitachi	Feldhäcksler ....-70	670	0	Sanden	SD7H15	133	8	12	KC	13	15
850889N	Fiat / Hitachi	Feldhäcksler ....-70	670T	0	Sanden	SD7H15	133	8	12	KC	13	15
850884N	Fiat / Hitachi	Schlepper ....-90	55-90DT	0	Sanden	SD5H14	132	2	12	N	13,5	13,5
850884N	Fiat / Hitachi	Schlepper ....-90	60-90DT	0	Sanden	SD5H14	132	2	12	N	13,5	13,5
850884N	Fiat / Hitachi	Schlepper ....-90	65-90DT	0	Sanden	SD5H14	132	2	12	N	13,5	13,5
850884N	Fiat / Hitachi	Schlepper ....-90	70-90DT	0	Sanden	SD5H14	132	2	12	N	13,5	13,5
850884N	Fiat / Hitachi	Schlepper ....-90	80-90DT	0	Sanden	SD5H14	132	2	12	N	13,5	13,5
850884N	Fiat / Hitachi	Schlepper ....-90	85-90DT	0	Sanden	SD5H14	132	2	12	N	13,5	13,5
850884N	Fiat / Hitachi	Schlepper ....-90	90-90DT	0	Sanden	SD5H14	132	2	12	N	13,5	13,5
850884N	Fiat / Hitachi	Schlepper ....-90	95-90DT	0	Sanden	SD5H14	132	2	12	N	13,5	13,5
850884N	Fiat / Hitachi	Schlepper ....-90	100-90DT	0	Sanden	SD5H14	132	2	12	N	13,5	13,5
850884N	Fiat / Hitachi	Schlepper ....-90	115-90DT	0	Sanden	SD5H14	132	2	12	N	13,5	13,5
850884N	Fiat / Hitachi	Schlepper ....-90	130-90	0	Sanden	SD5H14	132	2	12	N	13,5	13,5
850884N	Fiat / Hitachi	Schlepper ....-90	130-90DT	0	Sanden	SD5H14	132	2	12	N	13,5	13,5
850884N	Fiat / Hitachi	Schlepper ....-90	140-90	0	Sanden	SD5H14	132	2	12	N	13,5	13,5
850884N	Fiat / Hitachi	Schlepper ....-90	140-90DT	0	Sanden	SD5H14	132	2	12	N	13,5	13,5
850884N	Fiat / Hitachi	Schlepper ....-90	160-90	0	Sanden	SD5H14	132	2	12	N	13,5	13,5
850884N	Fiat / Hitachi	Schlepper ....-90	160-90DT	0	Sanden	SD5H14	132	2	12	N	13,5	13,5
850884N	Fiat / Hitachi	Schlepper ....-90	180-90	0	Sanden	SD5H14	132	2	12	N	13,5	13,5
850884N	Fiat / Hitachi	Schlepper ....-90	180-90DT	0	Sanden	SD5H14	132	2	12	N	13,5	13,5
850875N	Fiat / Hitachi	Schlepper / 9600	9630	0	Sanden	SD7H15	132	2	12	KG		
850875N	Fiat / Hitachi	Schlepper / 9600	9640	0	Sanden	SD7H15	132	2	12	KG		
850875N	Fiat / Hitachi	Schlepper / 9600	9645	0	Sanden	SD7H15	132	2	12	KG		

Dasis Nr.	Hersteller	Modell	Typ	KW	Herstellereinschränkung	Kompressor-ID	Riemenscheiben-Ø [mm]	Rippenanzahl	Spannung [V]	Zylinderkopf-ID (Kompressor)	Einlass-Ø [mm]	Auslass-Ø [mm]
850884N	Fiat / Hitachi	Schlepper / F	100	0	Sanden	SD5H14	132	2	12	N	13,5	13,5
851699N	Fiat / Hitachi	Schlepper / F	100	0	Sanden	SD7H15HD	132	2	12	CB	14	14
850884N	Fiat / Hitachi	Schlepper / F	100DT	0	Sanden	SD5H14	132	2	12	N	13,5	13,5
851699N	Fiat / Hitachi	Schlepper / F	100DT	0	Sanden	SD7H15HD	132	2	12	CB	14	14
850884N	Fiat / Hitachi	Schlepper / F	110	0	Sanden	SD5H14	132	2	12	N	13,5	13,5
851699N	Fiat / Hitachi	Schlepper / F	110	0	Sanden	SD7H15HD	132	2	12	CB	14	14
851699N	Fiat / Hitachi	Schlepper / F	110DT	0	Sanden	SD7H15HD	132	2	12	CB	14	14
850884N	Fiat / Hitachi	Schlepper / F	115	0	Sanden	SD5H14	132	2	12	N	13,5	13,5
851699N	Fiat / Hitachi	Schlepper / F	115	0	Sanden	SD7H15HD	132	2	12	CB	14	14
850884N	Fiat / Hitachi	Schlepper / F	115DT	0	Sanden	SD5H14	132	2	12	N	13,5	13,5
851699N	Fiat / Hitachi	Schlepper / F	115DT	0	Sanden	SD7H15HD	132	2	12	CB	14	14
850884N	Fiat / Hitachi	Schlepper / F	120	0	Sanden	SD5H14	132	2	12	N	13,5	13,5
851699N	Fiat / Hitachi	Schlepper / F	120	0	Sanden	SD7H15HD	132	2	12	CB	14	14
851699N	Fiat / Hitachi	Schlepper / F	120DT	0	Sanden	SD7H15HD	132	2	12	CB	14	14
850884N	Fiat / Hitachi	Schlepper / F	130	0	Sanden	SD5H14	132	2	12	N	13,5	13,5
851699N	Fiat / Hitachi	Schlepper / F	130	0	Sanden	SD7H15HD	132	2	12	CB	14	14
850884N	Fiat / Hitachi	Schlepper / F	130DT	0	Sanden	SD5H14	132	2	12	N	13,5	13,5
851699N	Fiat / Hitachi	Schlepper / F	130DT	0	Sanden	SD7H15HD	132	2	12	CB	14	14
850884N	Fiat / Hitachi	Schlepper / F	140	0	Sanden	SD5H14	132	2	12	N	13,5	13,5
851699N	Fiat / Hitachi	Schlepper / F	140	0	Sanden	SD7H15HD	132	2	12	CB	14	14
850884N	Fiat / Hitachi	Schlepper / F	140DT	0	Sanden	SD5H14	132	2	12	N	13,5	13,5
851699N	Fiat / Hitachi	Schlepper / F	140DT	0	Sanden	SD7H15HD	132	2	12	CB	14	14
850889N	Fiat / Hitachi	Schlepper / G	170	0	Sanden	SD7H15	133	8	12	KC	13	15
850889N	Fiat / Hitachi	Schlepper / G	190	0	Sanden	SD7H15	133	8	12	KC	13	15
850889N	Fiat / Hitachi	Schlepper / G	210	0	Sanden	SD7H15	133	8	12	KC	13	15
850889N	Fiat / Hitachi	Schlepper / G	240	0	Sanden	SD7H15	133	8	12	KC	13	15
851699N	Fiat / Hitachi	Schlepper / L	60	0	Sanden	SD7H15HD	132	2	12	CB	14	14
851699N	Fiat / Hitachi	Schlepper / L	65	0	Sanden	SD7H15HD	132	2	12	CB	14	14
851699N	Fiat / Hitachi	Schlepper / L	75	0	Sanden	SD7H15HD	132	2	12	CB	14	14
851699N	Fiat / Hitachi	Schlepper / L	85	0	Sanden	SD7H15HD	132	2	12	CB	14	14
851699N	Fiat / Hitachi	Schlepper / L	95	0	Sanden	SD7H15HD	132	2	12	CB	14	14



Dasis Nr.	Hersteller	Modell	Typ	KW	Herstellereinschränkung	Kompressor-ID	Riemenscheiben-Ø [mm]	Rippenanzahl	Spannung [V]	Zylinderkopf-ID (Kompressor)	Einlass-Ø [mm]	Auslass-Ø [mm]
851785N	Fiat / Hitachi	Schlepper / M	100	0	Sanden	SD7H15	120	8	12	JD	12,8	14,5
851785N	Fiat / Hitachi	Schlepper / M	115	0	Sanden	SD7H15	120	8	12	JD	12,8	14,5
851785N	Fiat / Hitachi	Schlepper / M	135	0	Sanden	SD7H15	120	8	12	JD	12,8	14,5
851785N	Fiat / Hitachi	Schlepper / M	160	0	Sanden	SD7H15	120	8	12	JD	12,8	14,5
851785N	Fiat / Hitachi	Schlepper / M	180	0	Sanden	SD7H15	120	8	12	JD	12,8	14,5
851107N	Gregoire	Schlepper / G	G10	0	Sanden	SD7H15	132	2	12		22	19
851107N	Gregoire	Schlepper / G	G84	0	Sanden	SD7H15	132	2	12		22	19
850327N	HÜRLIMANN	Bagger / XS	70	0	Sanden	SD7B10	115	2	12		14,9	12,2
850327N	HÜRLIMANN	Bagger / XS	75	0	Sanden	SD7B10	115	2	12		14,9	12,2
850327N	HÜRLIMANN	Bagger / XS	90	0	Sanden	SD7B10	115	2	12		14,9	12,2
850327N	HÜRLIMANN	Bagger / XS	100	0	Sanden	SD7B10	115	2	12		14,9	12,2
850892N	HÜRLIMANN	Schlepper / SX	1600	0	Sanden	7H15	132	2	12	MJ	15	15
850892N	HÜRLIMANN	Schlepper / SX	1800	0	Sanden	7H15	132	2	12	MJ	15	15
851111N	HÜRLIMANN	Schlepper / XB	6135	0	Sanden	SD5H14	132	2	12		14	14
850327N	HÜRLIMANN	Schlepper / XN	708	0	Sanden	SD7B10	115	2	12		14,9	12,2
850327N	HÜRLIMANN	Schlepper / XN	709	0	Sanden	SD7B10	115	2	12		14,9	12,2
853087N	Hyundai	Bagger / Robex	250LC-7	0	Delphi	V5	133	1	24		16	16
851726N	Hyundai	Schaufellader / HL	17	0	Seltec	TM15HD	120	8	12			
851726N	Hyundai	Schaufellader / HL	25	0	Seltec	TM15HD	120	8	12			
853087N	Hyundai	Schaufellader / HL	740-9	0	Delphi	V5	133	1	24		16	16
853087N	Hyundai	Schaufellader / HL	770-7A	0	Delphi	V5	133	1	24		16	16
853087N	Hyundai	Schaufellader / HL	960	0	Delphi	V5	133	1	24		16	16
851698N	JCB	Baggerlader	RTFL	0	Sanden	SD7H15	132	2	12			
851727N	JCB	Baggerlader / 400	406	0	Sanden	SD5H14	132	2	24	B	16	19
851727N	JCB	Baggerlader / 400	407	0	Sanden	SD5H14	132	2	24	B	16	19
851727N	JCB	Baggerlader / 400	409	0	Sanden	SD5H14	132	2	24	B	16	19
851727N	JCB	Baggerlader / 400	411	0	Sanden	SD5H14	132	2	24	B	16	19

Dasis Nr.	Hersteller	Modell	Typ	KW	Herstellereinschränkung	Kompressor-ID	Riemenscheiben-Ø [mm]	Rippenanzahl	Spannung [V]	Zylinderkopf-ID (Kompressor)	Einlass-Ø [mm]	Auslass-Ø [mm]
851727N	JCB	Baggerlader / 400	411B	0	Sanden	SD5H14	132	2	24	B	16	19
851727N	JCB	Baggerlader / 400	412	0	Sanden	SD5H14	132	2	24	B	16	19
851727N	JCB	Baggerlader / 400	412S	0	Sanden	SD5H14	132	2	24	B	16	19
851727N	JCB	Baggerlader / 400	414S	0	Sanden	SD5H14	132	2	24	B	16	19
851727N	JCB	Baggerlader / 400	415	0	Sanden	SD5H14	132	2	24	B	16	19
851727N	JCB	Baggerlader / 400	416	0	Sanden	SD5H14	132	2	24	B	16	19
851727N	JCB	Baggerlader / 400	416B	0	Sanden	SD5H14	132	2	24	B	16	19
851727N	JCB	Baggerlader / 400	416S	0	Sanden	SD5H14	132	2	24	B	16	19
851727N	JCB	Baggerlader / 400	420	0	Sanden	SD5H14	132	2	24	B	16	19
851727N	JCB	Baggerlader / 400	425	0	Sanden	SD5H14	132	2	24	B	16	19
851727N	JCB	Baggerlader / 400	426	0	Sanden	SD5H14	132	2	24	B	16	19
851727N	JCB	Baggerlader / 400	426B	0	Sanden	SD5H14	132	2	24	B	16	19
851727N	JCB	Baggerlader / 400	430	0	Sanden	SD5H14	132	2	24	B	16	19
851727N	JCB	Baggerlader / 400	435	0	Sanden	SD5H14	132	2	24	B	16	19
851727N	JCB	Baggerlader / 400	436	0	Sanden	SD5H14	132	2	24	B	16	19
851727N	JCB	Baggerlader / 400	436B	0	Sanden	SD5H14	132	2	24	B	16	19
851727N	JCB	Baggerlader / 400	446	0	Sanden	SD5H14	132	2	24	B	16	19
851727N	JCB	Baggerlader / 400	446B	0	Sanden	SD5H14	132	2	24	B	16	19
850851N	JCB	Baggerlader / 400	456	0	Sanden	SD7H15	125	2	24		13	16
851718N	JCB	Baggerlader / 400	456	0	Sanden	SD7H15	132	2	24	JD	16	14
858020N	JCB	Schlepper / Fastrac 100	125	0	Sanden	SD7H15HD	132	2	12	JD	13	16

Dasis Nr.	Hersteller	Modell	Typ	KW	Herstellereinschränkung	Kompressor-ID	Riemenscheiben-Ø [mm]	Rippenanzahl	Spannung [V]	Zylinderkopf-ID (Kompressor)	Einlass-Ø [mm]	Auslass-Ø [mm]
850456N	JCB	Schlepper / Fastrac 100	125	0	Sanden	SD508	132	2	12			
858020N	JCB	Schlepper / Fastrac 100	125-65	0	Sanden	SD7H15HD	132	2	12	JD	13	16
850456N	JCB	Schlepper / Fastrac 100	125-65	0	Sanden	SD508	132	2	12			
858020N	JCB	Schlepper / Fastrac 100	130	0	Sanden	SD7H15HD	132	2	12	JD	13	16
850456N	JCB	Schlepper / Fastrac 100	130	0	Sanden	SD508	132	2	12			
858020N	JCB	Schlepper / Fastrac 100	130-65	0	Sanden	SD7H15HD	132	2	12	JD	13	16
850456N	JCB	Schlepper / Fastrac 100	130-65	0	Sanden	SD508	132	2	12			
858020N	JCB	Schlepper / Fastrac 100	135	0	Sanden	SD7H15HD	132	2	12	JD	13	16
850456N	JCB	Schlepper / Fastrac 100	135	0	Sanden	SD508	132	2	12			
858020N	JCB	Schlepper / Fastrac 100	145	0	Sanden	SD7H15HD	132	2	12	JD	13	16
850456N	JCB	Schlepper / Fastrac 100	145	0	Sanden	SD508	132	2	12			
858020N	JCB	Schlepper / Fastrac 100	145-65	0	Sanden	SD7H15HD	132	2	12	JD	13	16
850456N	JCB	Schlepper / Fastrac 100	145-65	0	Sanden	SD508	132	2	12			
858020N	JCB	Schlepper / Fastrac 100	150	0	Sanden	SD7H15HD	132	2	12	JD	13	16
850456N	JCB	Schlepper / Fastrac 100	150	0	Sanden	SD508	132	2	12			
858020N	JCB	Schlepper / Fastrac 100	150-65	0	Sanden	SD7H15HD	132	2	12	JD	13	16
850456N	JCB	Schlepper / Fastrac 100	150-65	0	Sanden	SD508	132	2	12			
858020N	JCB	Schlepper / Fastrac 100	155	0	Sanden	SD7H15HD	132	2	12	JD	13	16
850456N	JCB	Schlepper / Fastrac 100	155	0	Sanden	SD508	132	2	12			
858020N	JCB	Schlepper / Fastrac 100	185	0	Sanden	SD7H15HD	132	2	12	JD	13	16
850456N	JCB	Schlepper / Fastrac 100	185	0	Sanden	SD508	132	2	12			

Dasis Nr.	Hersteller	Modell	Typ	KW	Herstellereinschränkung	Kompressor-ID	Riemenscheiben-Ø [mm]	Rippenanzahl	Spannung [V]	Zylinderkopf-ID (Kompressor)	Einlass-Ø [mm]	Auslass-Ø [mm]
858020N	JCB	Schlepper / Fastrac 1000	1115	0	Sanden	SD7H15HD	132	2	12	JD	13	16
858020N	JCB	Schlepper / Fastrac 1000	1115S	0	Sanden	SD7H15HD	132	2	12	JD	13	16
858020N	JCB	Schlepper / Fastrac 1000	1125	0	Sanden	SD7H15HD	132	2	12	JD	13	16
858020N	JCB	Schlepper / Fastrac 1000	1135	0	Sanden	SD7H15HD	132	2	12	JD	13	16
858020N	JCB	Schlepper / Fastrac 2000	2115	0	Sanden	SD7H15HD	132	2	12	JD	13	16
858020N	JCB	Schlepper / Fastrac 2000	2125	0	Sanden	SD7H15HD	132	2	12	JD	13	16
858020N	JCB	Schlepper / Fastrac 2000	2135	0	Sanden	SD7H15HD	132	2	12	JD	13	16
858020N	JCB	Schlepper / Fastrac 2000	2150	0	Sanden	SD7H15HD	132	2	12	JD	13	16
850896N	JCB	Teleskoplader / 500 Serie	504B	0	Sanden	SD7H15HD	125	2	12		13	16
850896N	JCB	Teleskoplader / 500 Serie	506	0	Sanden	SD7H15HD	125	2	12		13	16
850896N	JCB	Teleskoplader / 500 Serie	506B	0	Sanden	SD7H15HD	125	2	12		13	16
850896N	JCB	Teleskoplader / 500 Serie	506C	0	Sanden	SD7H15HD	125	2	12		13	16
850896N	JCB	Teleskoplader / 500 Serie	506CHL	0	Sanden	SD7H15HD	125	2	12		13	16
850896N	JCB	Teleskoplader / 500 Serie	506HL	0	Sanden	SD7H15HD	125	2	12		13	16
850896N	JCB	Teleskoplader / 500 Serie	508C	0	Sanden	SD7H15HD	125	2	12		13	16
850896N	JCB	Teleskoplader / 500 Serie	520	0	Sanden	SD7H15HD	125	2	12		13	16
850896N	JCB	Teleskoplader / 500 Serie	520HL	0	Sanden	SD7H15HD	125	2	12		13	16
850896N	JCB	Teleskoplader / 500 Serie	520M	0	Sanden	SD7H15HD	125	2	12		13	16
850896N	JCB	Teleskoplader / 500 Serie	520S	0	Sanden	SD7H15HD	125	2	12		13	16
850896N	JCB	Teleskoplader / 500 Serie	525	0	Sanden	SD7H15HD	125	2	12		13	16
850896N	JCB	Teleskoplader / 500 Serie	525B	0	Sanden	SD7H15HD	125	2	12		13	16

Dasis Nr.	Hersteller	Modell	Typ	KW	Herstellereinschränkung	Kompressor-ID	Riemenscheiben-Ø [mm]	Rippenanzahl	Spannung [V]	Zylinderkopf-ID (Kompressor)	Einlass-Ø [mm]	Auslass-Ø [mm]
850896N	JCB	Teleskoplader / 500 Serie	525BHL	0	Sanden	SD7H15HD	125	2	12		13	16
850896N	JCB	Teleskoplader / 500 Serie	525HL	0	Sanden	SD7H15HD	125	2	12		13	16
850896N	JCB	Teleskoplader / 500 Serie	526	0	Sanden	SD7H15HD	125	2	12		13	16
850896N	JCB	Teleskoplader / 500 Serie	526S	0	Sanden	SD7H15HD	125	2	12		13	16
850896N	JCB	Teleskoplader / 500 Serie	528AG	0	Sanden	SD7H15HD	125	2	12		13	16
850698N	JCB	Teleskoplader / 500 Serie	528S	0	Zexel	DKS17CH	120	6	12		14,6	14,6
850896N	JCB	Teleskoplader / 500 Serie	530	0	Sanden	SD7H15HD	125	2	12		13	16
850896N	JCB	Teleskoplader / 500 Serie	530B	0	Sanden	SD7H15HD	125	2	12		13	16
850896N	JCB	Teleskoplader / 500 Serie	530BHL	0	Sanden	SD7H15HD	125	2	12		13	16
850896N	JCB	Teleskoplader / 500 Serie	530FS	0	Sanden	SD7H15HD	125	2	12		13	16
850896N	JCB	Teleskoplader / 500 Serie	530FSPlus	0	Sanden	SD7H15HD	125	2	12		13	16
850896N	JCB	Teleskoplader / 500 Serie	530FSSUPER	0	Sanden	SD7H15HD	125	2	12		13	16
850896N	JCB	Teleskoplader / 500 Serie	530HL	0	Sanden	SD7H15HD	125	2	12		13	16
850896N	JCB	Teleskoplader / 500 Serie	530S	0	Sanden	SD7H15HD	125	2	12		13	16
850896N	JCB	Teleskoplader / 500 Serie	530SL	0	Sanden	SD7H15HD	125	2	12		13	16
850896N	JCB	Teleskoplader / 500 Serie	530SUPERAG	0	Sanden	SD7H15HD	125	2	12		13	16
850896N	JCB	Teleskoplader / 500 Serie	530S XL	0	Sanden	SD7H15HD	125	2	12		13	16
850896N	JCB	Teleskoplader / 500 Serie	531S	0	Sanden	SD7H15HD	125	2	12		13	16
850896N	JCB	Teleskoplader / 500 Serie	532	0	Sanden	SD7H15HD	125	2	12		13	16
850896N	JCB	Teleskoplader / 500 Serie	532H	0	Sanden	SD7H15HD	125	2	12		13	16
850896N	JCB	Teleskoplader / 500 Serie	535	0	Sanden	SD7H15HD	125	2	12		13	16

Dasis Nr.	Hersteller	Modell	Typ	KW	Herstellereinschränkung	Kompressor-ID	Riemenscheiben-Ø [mm]	Rippenanzahl	Spannung [V]	Zylinderkopf-ID (Kompressor)	Einlass-Ø [mm]	Auslass-Ø [mm]
850896N	JCB	Teleskopklader / 500 Serie	537	0	Sanden	SD7H15HD	125	2	12		13	16
850896N	JCB	Teleskopklader / 500 Serie	537H	0	Sanden	SD7H15HD	125	2	12		13	16
850896N	JCB	Teleskopklader / 500 Serie	540	0	Sanden	SD7H15HD	125	2	12		13	16
850896N	JCB	Teleskopklader / 500 Serie	540B	0	Sanden	SD7H15HD	125	2	12		13	16
850896N	JCB	Teleskopklader / 500 Serie	540BM	0	Sanden	SD7H15HD	125	2	12		13	16
850896N	JCB	Teleskopklader / 500 Serie	540FS	0	Sanden	SD7H15HD	125	2	12		13	16
850896N	JCB	Teleskopklader / 500 Serie	540FSPlus	0	Sanden	SD7H15HD	125	2	12		13	16
850896N	JCB	Teleskopklader / 500 Serie	540FSSUPER	0	Sanden	SD7H15HD	125	2	12		13	16
850896N	JCB	Teleskopklader / 500 Serie	540S	0	Sanden	SD7H15HD	125	2	12		13	16
850896N	JCB	Teleskopklader / 500 Serie	540SL	0	Sanden	SD7H15HD	125	2	12		13	16
850896N	JCB	Teleskopklader / 500 Serie	540SUPERAG	0	Sanden	SD7H15HD	125	2	12		13	16
850896N	JCB	Teleskopklader / 500 Serie	540S XL	0	Sanden	SD7H15HD	125	2	12		13	16
850896N	JCB	Teleskopklader / 500 Serie	550	0	Sanden	SD7H15HD	125	2	12		13	16
850896N	JCB	Teleskopklader / 500 Serie	5508	0	Sanden	SD7H15HD	125	2	12		13	16
851698N	JCB	Teleskopklader / Fastrac 3000	3155	0	Sanden	SD7H15	132	2	12			
851698N	JCB	Teleskopklader / Fastrac 3000	3185	0	Sanden	SD7H15	132	2	12			
851698N	JCB	Teleskopklader / Fastrac 3000	3190	0	Sanden	SD7H15	132	2	12			
851698N	JCB	Teleskopklader / Fastrac 3000	3220	0	Sanden	SD7H15	132	2	12			
851698N	JCB	Teleskopklader / SXL	530	0	Sanden	SD7H15	132	2	12			
851698N	JCB	Teleskopklader / SXL	540	0	Sanden	SD7H15	132	2	12			
851698N	JCB	Teleskopklader / TM	300	0	Sanden	SD7H15	132	2	12			

Dasis Nr.	Hersteller	Modell	Typ	KW	Herstellereinschränkung	Kompressor-ID	Riemenscheiben-Ø [mm]	Rippenanzahl	Spannung [V]	Zylinderkopf-ID (Kompressor)	Einlass-Ø [mm]	Auslass-Ø [mm]
851755N	John Deere	Baggerlader / 110-726B	300	0	Denso	10PA17C	146	1	12			
851099N	John Deere	Baggerlader / 110-726B	300	0	Denso	10PA17C	146	8	12		16	21
850516N	John Deere	Baggerlader / 110-726B	310	0	Denso	6E171	146	1	12			
851755N	John Deere	Baggerlader / 110-726B	310	0	Denso	10PA17C	146	1	12			
851099N	John Deere	Baggerlader / 110-726B	310	0	Denso	10PA17C	146	8	12		16	21
851099N	John Deere	Baggerlader / 110-726B	310E	0	Denso	10PA17C	146	8	12		16	21
851099N	John Deere	Baggerlader / 110-726B	310G	0	Denso	10PA17C	146	8	12		16	21
851099N	John Deere	Baggerlader / 110-726B	310SE	0	Denso	10PA17C	146	8	12		16	21
851099N	John Deere	Baggerlader / 110-726B	310SG	0	Denso	10PA17C	146	8	12		16	21
850516N	John Deere	Baggerlader / 110-726B	315	0	Denso	6E171	146	1	12			
851755N	John Deere	Baggerlader / 110-726B	315	0	Denso	10PA17C	146	1	12			
851099N	John Deere	Baggerlader / 110-726B	315	0	Denso	10PA17C	146	8	12		16	21
851099N	John Deere	Baggerlader / 110-726B	315SG	0	Denso	10PA17C	146	8	12		16	21
851755N	John Deere	Baggerlader / 110-726B	410	0	Denso	10PA17C	146	1	12			
851099N	John Deere	Baggerlader / 110-726B	410	0	Denso	10PA17C	146	8	12		16	21
850516N	John Deere	Baggerlader / 110-726B	410B	0	Denso	6E171	146	1	12			
851755N	John Deere	Baggerlader / 110-726B	410E	0	Denso	10PA17C	146	1	12			
851099N	John Deere	Baggerlader / 110-726B	410E	0	Denso	10PA17C	146	8	12		16	21
851099N	John Deere	Baggerlader / 110-726B	410G	0	Denso	10PA17C	146	8	12		16	21
850516N	John Deere	Baggerlader / 110-726B	510	0	Denso	6E171	146	1	12			
851755N	John Deere	Baggerlader / 110-726B	510	0	Denso	10PA17C	146	1	12			

Dasis Nr.	Hersteller	Modell	Typ	KW	Herstellereinschränkung	Kompressor-ID	Riemenscheiben-Ø [mm]	Rippenanzahl	Spannung [V]	Zylinderkopf-ID (Kompressor)	Einlass-Ø [mm]	Auslass-Ø [mm]
851099N	John Deere	Baggerlader / 110-726B	510	0	Denso	10PA17C	146	8	12		16	21
850516N	John Deere	Baggerlader / 110-726B	510B	0	Denso	6E171	146	1	12			
851754N	John Deere	Baggerlader / 110-726B	544J	0	Denso	10PA17C	146	8	24			
851755N	John Deere	Baggerlader / 110-726B	624G	0	Denso	10PA17C	146	1	12			
851755N	John Deere	Baggerlader / 110-726B	710	0	Denso	10PA17C	146	1	12			
850409N	John Deere	Baggerlader / 110-726B	726B	0	GM Harrison	A6	139	1	12			
851753N	John Deere	Baggerlader / 110-726B	726B	0	GM Harrison	A6	139	1	12		16	16
850340N	John Deere	Feldhäcksler / 3400-3420	3400	0	Denso	10PA15C	125	8	12			
850340N	John Deere	Feldhäcksler / 3400-3420	3415	0	Denso	10PA15C	125	8	12			
850340N	John Deere	Feldhäcksler / 3400-3420	3420	0	Denso	10PA15C	125	8	12			
850863N	John Deere	Feldhäcksler / 5030-5730	5200	0	Denso	10PA15C	135	2	12			
850863N	John Deere	Feldhäcksler / 5030-5730	5400	0	Denso	10PA15C	135	2	12			
850516N	John Deere	Feldhäcksler / 5030-5730	5720	0	Denso	6E171	146	1	12			
850516N	John Deere	Feldhäcksler / 5030-5730	5730	0	Denso	6E171	146	1	12			
850863N	John Deere	Feldhäcksler / 6010-6950	6610	0	Denso	10PA15C	135	2	12			
850863N	John Deere	Feldhäcksler / 6010-6950	6650	0	Denso	10PA15C	135	2	12			
850863N	John Deere	Feldhäcksler / 6010-6950	6710	0	Denso	10PA15C	135	2	12			
850863N	John Deere	Feldhäcksler / 6010-6950	6750	0	Denso	10PA15C	135	2	12			
850863N	John Deere	Feldhäcksler / 6010-6950	6810	0	Denso	10PA15C	135	2	12			
850863N	John Deere	Feldhäcksler / 6010-6950	6850	0	Denso	10PA15C	135	2	12			
850863N	John Deere	Feldhäcksler / 6010-6950	6910	0	Denso	10PA15C	135	2	12			



Dasis Nr.	Hersteller	Modell	Typ	KW	Herstellereinschränkung	Kompressor-ID	Riemenscheiben-Ø [mm]	Rippenanzahl	Spannung [V]	Zylinderkopf-ID (Kompressor)	Einlass-Ø [mm]	Auslass-Ø [mm]
850863N	John Deere	Feldhäcksler / 6010-6950	6950	0	Denso	10PA15C	135	2	12			
852991N	John Deere	Forstmaschine / 800-900	803M	0	Denso	10SRE18C	125	8	24			
852991N	John Deere	Forstmaschine / 800-900	853M	0	Denso	10SRE18C	125	8	24			
852991N	John Deere	Forstmaschine / 800-900	859M	0	Denso	10SRE18C	125	8	24			
852991N	John Deere	Forstmaschine / 800-900	903M	0	Denso	10SRE18C	125	8	24			
852991N	John Deere	Forstmaschine / 800-900	909M	0	Denso	10SRE18C	125	8	24			
852991N	John Deere	Forstmaschine / 800-900	953M	0	Denso	10SRE18C	125	8	24			
852991N	John Deere	Forstmaschine / 800-900	959M	0	Denso	10SRE18C	125	8	24			
851784N	John Deere	Forstmaschine / 5025-5525	5025	0	Harrison	HR6	120	8	12		16	16
851784N	John Deere	Forstmaschine / 5025-5525	5425	0	Harrison	HR6	120	8	12		16	16
851784N	John Deere	Forstmaschine / 5025-5525	5525	0	Harrison	HR6	120	8	12		16	16
850409N	John Deere	Mähdrescher / 900-1188	955	0	GM Harrison	A6	139	1	12			
851753N	John Deere	Mähdrescher / 900-1188	955	0	GM Harrison	A6	139	1	12		16	16
850409N	John Deere	Mähdrescher / 900-1188	965	0	GM Harrison	A6	139	1	12			
851753N	John Deere	Mähdrescher / 900-1188	965	0	GM Harrison	A6	139	1	12		16	16
850409N	John Deere	Mähdrescher / 900-1188	975	0	GM Harrison	A6	139	1	12			
851753N	John Deere	Mähdrescher / 900-1188	975	0	GM Harrison	A6	139	1	12		16	16
850409N	John Deere	Mähdrescher / 900-1188	985	0	GM Harrison	A6	139	1	12			
851753N	John Deere	Mähdrescher / 900-1188	985	0	GM Harrison	A6	139	1	12		16	16
850409N	John Deere	Mähdrescher / 900-1188	1052	0	GM Harrison	A6	139	1	12			
851753N	John Deere	Mähdrescher / 900-1188	1052	0	GM Harrison	A6	139	1	12		16	16

Dasis Nr.	Hersteller	Modell	Typ	KW	Herstellereinschränkung	Kompressor-ID	Riemenscheiben-Ø [mm]	Rippenanzahl	Spannung [V]	Zylinderkopf-ID (Kompressor)	Einlass-Ø [mm]	Auslass-Ø [mm]
850409N	John Deere	Mähdrescher / 900-1188	1055	0	GM Harrison	A6	139	1	12			
851753N	John Deere	Mähdrescher / 900-1188	1055	0	GM Harrison	A6	139	1	12		16	16
850409N	John Deere	Mähdrescher / 900-1188	1065	0	GM Harrison	A6	139	1	12			
851753N	John Deere	Mähdrescher / 900-1188	1065	0	GM Harrison	A6	139	1	12		16	16
850409N	John Deere	Mähdrescher / 900-1188	1068H	0	GM Harrison	A6	139	1	12			
851753N	John Deere	Mähdrescher / 900-1188	1068H	0	GM Harrison	A6	139	1	12		16	16
850409N	John Deere	Mähdrescher / 900-1188	1072	0	GM Harrison	A6	139	1	12			
851753N	John Deere	Mähdrescher / 900-1188	1072	0	GM Harrison	A6	139	1	12		16	16
850409N	John Deere	Mähdrescher / 900-1188	1075	0	GM Harrison	A6	139	1	12			
851753N	John Deere	Mähdrescher / 900-1188	1075	0	GM Harrison	A6	139	1	12		16	16
850409N	John Deere	Mähdrescher / 900-1188	1075H4	0	GM Harrison	A6	139	1	12			
851753N	John Deere	Mähdrescher / 900-1188	1075H4	0	GM Harrison	A6	139	1	12		16	16
850409N	John Deere	Mähdrescher / 900-1188	1085	0	GM Harrison	A6	139	1	12			
851753N	John Deere	Mähdrescher / 900-1188	1085	0	GM Harrison	A6	139	1	12		16	16
850409N	John Deere	Mähdrescher / 900-1188	1085H4	0	GM Harrison	A6	139	1	12			
851753N	John Deere	Mähdrescher / 900-1188	1085H4	0	GM Harrison	A6	139	1	12		16	16
850516N	John Deere	Mähdrescher / 900-1188	1155	0	Denso	6E171	146	1	12			
850516N	John Deere	Mähdrescher / 900-1188	1157	0	Denso	6E171	146	1	12			
850516N	John Deere	Mähdrescher / 900-1188	1158	0	Denso	6E171	146	1	12			
850516N	John Deere	Mähdrescher / 900-1188	1166	0	Denso	6E171	146	1	12			
850516N	John Deere	Mähdrescher / 900-1188	1169	0	Denso	6E171	146	1	12			

Dasis Nr.	Hersteller	Modell	Typ	KW	Herstellereinschränkung	Kompressor-ID	Riemenscheiben-Ø [mm]	Rippenanzahl	Spannung [V]	Zylinderkopf-ID (Kompressor)	Einlass-Ø [mm]	Auslass-Ø [mm]
850516N	John Deere	Mähdrescher / 900-1188	1169H	0	Denso	6E171	146	1	12			
850516N	John Deere	Mähdrescher / 900-1188	1169H4	0	Denso	6E171	146	1	12			
850516N	John Deere	Mähdrescher / 900-1188	1170	0	Denso	6E171	146	1	12			
850516N	John Deere	Mähdrescher / 900-1188	1174	0	Denso	6E171	146	1	12			
850516N	John Deere	Mähdrescher / 900-1188	1175	0	Denso	6E171	146	1	12			
850516N	John Deere	Mähdrescher / 900-1188	1177	0	Denso	6E171	146	1	12			
850516N	John Deere	Mähdrescher / 900-1188	1177H4	0	Denso	6E171	146	1	12			
850516N	John Deere	Mähdrescher / 900-1188	1188	0	Denso	6E171	146	1	12			
850516N	John Deere	Mähdrescher / 900-1188	1188H4	0	Denso	6E171	146	1	12			
852991N	John Deere	Mähdrescher / 1000-2000	1070E	0	Denso	10SRE18C	125	8	24			
852991N	John Deere	Mähdrescher / 1000-2000	1170E	0	Denso	10SRE18C	125	8	24			
852991N	John Deere	Mähdrescher / 1000-2000	1270E	0	Denso	10SRE18C	125	8	24			
852991N	John Deere	Mähdrescher / 1000-2000	1470E	0	Denso	10SRE18C	125	8	24			
850863N	John Deere	Mähdrescher / 2000-2266	2054	0	Denso	10PA15C	135	2	12			
850863N	John Deere	Mähdrescher / 2000-2266	2056	0	Denso	10PA15C	135	2	12			
850863N	John Deere	Mähdrescher / 2000-2266	2058	0	Denso	10PA15C	135	2	12			
850863N	John Deere	Mähdrescher / 2000-2266	2064	0	Denso	10PA15C	135	2	12			
850863N	John Deere	Mähdrescher / 2000-2266	2066	0	Denso	10PA15C	135	2	12			
850863N	John Deere	Mähdrescher / 2000-2266	2254	0	Denso	10PA15C	135	2	12			
850863N	John Deere	Mähdrescher / 2000-2266	2256	0	Denso	10PA15C	135	2	12			
850863N	John Deere	Mähdrescher / 2000-2266	2258	0	Denso	10PA15C	135	2	12			

Dasis Nr.	Hersteller	Modell	Typ	KW	Herstellereinschränkung	Kompressor-ID	Riemenscheiben-Ø [mm]	Rippenanzahl	Spannung [V]	Zylinderkopf-ID (Kompressor)	Einlass-Ø [mm]	Auslass-Ø [mm]
850863N	John Deere	Mähdrescher / 2000-2266	2264	0	Denso	10PA15C	135	2	12			
850863N	John Deere	Mähdrescher / 2000-2266	2266	0	Denso	10PA15C	135	2	12			
850863N	John Deere	Mähdrescher / 2000-2266	2266Extra	0	Denso	10PA15C	135	2	12			
850421N	John Deere	Mähdrescher / 4000-8850	4400	0	York	F209/210R			12		14	11,9
850422N	John Deere	Mähdrescher / 4000-8850	4400	0	York	R209/210R	ohne Riemenscheibe	ohne Riemenscheibe			13,5	13,5
850421N	John Deere	Mähdrescher / 4000-8850	6600	0	York	F209/210R			12		14	11,9
850422N	John Deere	Mähdrescher / 4000-8850	6600	0	York	R209/210R	ohne Riemenscheibe	ohne Riemenscheibe			13,5	13,5
851779N	John Deere	Mähdrescher / 4000-8850	6620	0	Tecumseh	HG850-1000						
851779N	John Deere	Mähdrescher / 4000-8850	6622	0	Tecumseh	HG850-1000						
851755N	John Deere	Mähdrescher / 4000-8850	7455	0	Denso	10PA17C	146	1	12			
850516N	John Deere	Mähdrescher / 4000-8850	7700	0	Denso	6E171	146	1	12			
850409N	John Deere	Mähdrescher / 4000-8850	7700	0	GM Harrison	A6	139	1	12			
851753N	John Deere	Mähdrescher / 4000-8850	7700	0	GM Harrison	A6	139	1	12		16	16
850516N	John Deere	Mähdrescher / 4000-8850	7720	0	Denso	6E171	146	1	12			
851753N	John Deere	Mähdrescher / 4000-8850	7720	0	GM Harrison	A6	139	1	12		16	16
850516N	John Deere	Mähdrescher / 4000-8850	7722	0	Denso	6E171	146	1	12			
851753N	John Deere	Mähdrescher / 4000-8850	7722	0	GM Harrison	A6	139	1	12		16	16
850516N	John Deere	Mähdrescher / 4000-8850	8820	0	Denso	6E171	146	1	12			
850409N	John Deere	Mähdrescher / 4000-8850	8820	0	GM Harrison	A6	139	1	12			
851753N	John Deere	Mähdrescher / 4000-8850	8820	0	GM Harrison	A6	139	1	12		16	16
850516N	John Deere	Mähdrescher / 9000-9980	9400	0	Denso	6E171	146	1	12			

Dasis Nr.	Hersteller	Modell	Typ	KW	Herstellereinschränkung	Kompressor-ID	Riemenscheiben-Ø [mm]	Rippenanzahl	Spannung [V]	Zylinderkopf-ID (Kompressor)	Einlass-Ø [mm]	Auslass-Ø [mm]
851755N	John Deere	Mähdrescher / 9000-9980	9400	0	Denso	10PA17C	146	1	12			
850409N	John Deere	Mähdrescher / 9000-9980	9400	0	GM Harrison	A6	139	1	12			
851753N	John Deere	Mähdrescher / 9000-9980	9400	0	GM Harrison	A6	139	1	12		16	16
851099N	John Deere	Mähdrescher / 9000-9980	9410	0	Denso	10PA17C	146	8	12		16	21
851099N	John Deere	Mähdrescher / 9000-9980	9450	0	Denso	10PA17C	146	8	12		16	21
850516N	John Deere	Mähdrescher / 9000-9980	9500	0	Denso	6E171	146	1	12			
851755N	John Deere	Mähdrescher / 9000-9980	9500	0	Denso	10PA17C	146	1	12			
850409N	John Deere	Mähdrescher / 9000-9980	9500	0	GM Harrison	A6	139	1	12			
851753N	John Deere	Mähdrescher / 9000-9980	9500	0	GM Harrison	A6	139	1	12		16	16
851099N	John Deere	Mähdrescher / 9000-9980	9510	0	Denso	10PA17C	146	8	12		16	21
851099N	John Deere	Mähdrescher / 9000-9980	9540	0	Denso	10PA17C	146	8	12		16	21
851099N	John Deere	Mähdrescher / 9000-9980	9550	0	Denso	10PA17C	146	8	12		16	21
851099N	John Deere	Mähdrescher / 9000-9980	9560	0	Denso	10PA17C	146	8	12		16	21
850516N	John Deere	Mähdrescher / 9000-9980	9600	0	Denso	6E171	146	1	12			
851755N	John Deere	Mähdrescher / 9000-9980	9600	0	Denso	10PA17C	146	1	12			
850409N	John Deere	Mähdrescher / 9000-9980	9600	0	GM Harrison	A6	139	1	12			
851753N	John Deere	Mähdrescher / 9000-9980	9600	0	GM Harrison	A6	139	1	12		16	16
851099N	John Deere	Mähdrescher / 9000-9980	9640	0	Denso	10PA17C	146	8	12		16	21
851099N	John Deere	Mähdrescher / 9000-9980	9650	0	Denso	10PA17C	146	8	12		16	21
851099N	John Deere	Mähdrescher / 9000-9980	9750	0	Denso	10PA17C	146	8	12		16	21
851099N	John Deere	Mähdrescher / 9000-9980	9930	0	Denso	10PA17C	146	8	12		16	21

Dasis Nr.	Hersteller	Modell	Typ	KW	Herstellereinschränkung	Kompressor-ID	Riemenscheiben-Ø [mm]	Rippenanzahl	Spannung [V]	Zylinderkopf-ID (Kompressor)	Einlass-Ø [mm]	Auslass-Ø [mm]
851099N	John Deere	Mähdrescher / 9000-9980	9950	0	Denso	10PA17C	146	8	12		16	21
851099N	John Deere	Mähdrescher / 9000-9980	9960	0	Denso	10PA17C	146	8	12		16	21
851099N	John Deere	Mähdrescher / 9000-9980	9980	0	Denso	10PA17C	146	8	12		16	21
851753N	John Deere	Mähdrescher / CTS	CTS II	0	GM Harrison	A6	139	1	12		16	16
850421N	John Deere	Mähdrescher / CTS	CTS II	0	York	F209/210R			12		14	11,9
851099N	John Deere	Minibagger / 200-800	280	0	Denso	10PA17C	146	8	12		16	21
851099N	John Deere	Minibagger / 200-800	317	0	Denso	10PA17C	146	8	12		16	21
851099N	John Deere	Minibagger / 200-800	320	0	Denso	10PA17C	146	8	12		16	21
851099N	John Deere	Minibagger / 200-800	325	0	Denso	10PA17C	146	8	12		16	21
851099N	John Deere	Minibagger / 200-800	328	0	Denso	10PA17C	146	8	12		16	21
851755N	John Deere	Minibagger / 200-800	531S	0	Denso	10PA17C	146	1	12			
851755N	John Deere	Minibagger / 200-800	540E	0	Denso	10PA17C	146	1	12			
851755N	John Deere	Minibagger / 200-800	540G	0	Denso	10PA17C	146	1	12			
851755N	John Deere	Minibagger / 200-800	548E	0	Denso	10PA17C	146	1	12			
851755N	John Deere	Minibagger / 200-800	640E	0	Denso	10PA17C	146	1	12			
851755N	John Deere	Minibagger / 200-800	640G	0	Denso	10PA17C	146	1	12			
851755N	John Deere	Minibagger / 200-800	648E	0	Denso	10PA17C	146	1	12			
851755N	John Deere	Minibagger / 200-800	740E	0	Denso	10PA17C	146	1	12			
851755N	John Deere	Minibagger / 200-800	740G	0	Denso	10PA17C	146	1	12			
851754N	John Deere	Motorgrader / 400-800	400	0	Denso	10PA17C	146	8	24			
851759N	John Deere	Motorgrader / 400-800	670	0	Denso	10PA17C	146	1	24			

Dasis Nr.	Hersteller	Modell	Typ	KW	Herstellereinschränkung	Kompressor-ID	Riemenscheiben-Ø [mm]	Rippenanzahl	Spannung [V]	Zylinderkopf-ID (Kompressor)	Einlass-Ø [mm]	Auslass-Ø [mm]
851754N	John Deere	Motorgrader / 400-800	670	0	Denso	10PA17C	146	8	24			
851759N	John Deere	Motorgrader / 400-800	670B	0	Denso	10PA17C	146	1	24			
851754N	John Deere	Motorgrader / 400-800	670H	0	Denso	10PA17C	146	8	24			
851759N	John Deere	Motorgrader / 400-800	672	0	Denso	10PA17C	146	1	24			
851759N	John Deere	Motorgrader / 400-800	672B	0	Denso	10PA17C	146	1	24			
851754N	John Deere	Motorgrader / 400-800	672H	0	Denso	10PA17C	146	8	24			
851759N	John Deere	Motorgrader / 400-800	770	0	Denso	10PA17C	146	1	24			
851759N	John Deere	Motorgrader / 400-800	770B	0	Denso	10PA17C	146	1	24			
851759N	John Deere	Motorgrader / 400-800	770BH	0	Denso	10PA17C	146	1	24			
851754N	John Deere	Motorgrader / 400-800	772	0	Denso	10PA17C	146	8	24			
851759N	John Deere	Motorgrader / 400-800	772B	0	Denso	10PA17C	146	1	24			
851759N	John Deere	Motorgrader / 400-800	772BH	0	Denso	10PA17C	146	1	24			
851754N	John Deere	Motorgrader / 400-800	870	0	Denso	10PA17C	146	8	24			
852991N	John Deere	Motor Grader / G / GP Serie	670	0	Denso	10SRE18C	125	8	24			
852991N	John Deere	Motor Grader / G / GP Serie	672	0	Denso	10SRE18C	125	8	24			
852991N	John Deere	Motor Grader / G / GP Serie	770	0	Denso	10SRE18C	125	8	24			
852991N	John Deere	Motor Grader / G / GP Serie	772	0	Denso	10SRE18C	125	8	24			
852991N	John Deere	Motor Grader / G / GP Serie	870	0	Denso	10SRE18C	125	8	24			
852991N	John Deere	Motor Grader / G / GP Serie	872	0	Denso	10SRE18C	125	8	24			
851754N	John Deere	Muldenkipper / 200-700	250	0	Denso	10PA17C	146	8	24			
852991N	John Deere	Muldenkipper / 200-700	250D	0	Denso	10SRE18C	125	8	24			

Dasis Nr.	Hersteller	Modell	Typ	KW	Herstellereinschränkung	Kompressor-ID	Riemenscheiben-Ø [mm]	Rippenanzahl	Spannung [V]	Zylinderkopf-ID (Kompressor)	Einlass-Ø [mm]	Auslass-Ø [mm]
851754N	John Deere	Muldenkipper / 200-700	300	0	Denso	10PA17C	146	8	24			
852991N	John Deere	Muldenkipper / 200-700	300D	0	Denso	10SRE18C	125	8	24			
851754N	John Deere	Muldenkipper / 200-700	350	0	Denso	10PA17C	146	8	24			
852991N	John Deere	Muldenkipper / 200-700	370E	0	Denso	10SRE18C	125	8	24			
852991N	John Deere	Muldenkipper / 200-700	410E	0	Denso	10SRE18C	125	8	24			
852991N	John Deere	Muldenkipper / 200-700	460E	0	Denso	10SRE18C	125	8	24			
851755N	John Deere	Muldenkipper / 200-700	748E	0	Denso	10PA17C	146	1	12			
851099N	John Deere	Raupen Dozer / 400-850	450H	0	Denso	10PA17C	146	8	12		16	21
851099N	John Deere	Raupen Dozer / 400-850	550H	0	Denso	10PA17C	146	8	12		16	21
852991N	John Deere	Raupen Dozer / 400-850	550K	0	Denso	10SRE18C	125	8	24			
852991N	John Deere	Raupen Dozer / 400-850	605K	0	Denso	10SRE18C	125	8	24			
851099N	John Deere	Raupen Dozer / 400-850	650H	0	Denso	10PA17C	146	8	12		16	21
852991N	John Deere	Raupen Dozer / 400-850	650K	0	Denso	10SRE18C	125	8	24			
851790N	John Deere	Raupen Dozer / 400-850	655B	0		S6	170	1	24			
851759N	John Deere	Raupen Dozer / 400-850	655B	0	Denso	10PA17C	146	1	24			
852991N	John Deere	Raupen Dozer / 400-850	655K	0	Denso	10SRE18C	125	8	24			
851754N	John Deere	Raupen Dozer / 400-850	700H	0	Denso	10PA17C	146	8	24			
851099N	John Deere	Raupen Dozer / 400-850	710	0	Denso	10PA17C	146	8	12		16	21
851759N	John Deere	Raupen Dozer / 400-850	750	0	Denso	10PA17C	146	1	24			
851754N	John Deere	Raupen Dozer / 400-850	750	0	Denso	10PA17C	146	8	24			
851759N	John Deere	Raupen Dozer / 400-850	750B	0	Denso	10PA17C	146	1	24			



Dasis Nr.	Hersteller	Modell	Typ	KW	Herstellereinschränkung	Kompressor-ID	Riemenscheiben-Ø [mm]	Rippenanzahl	Spannung [V]	Zylinderkopf-ID (Kompressor)	Einlass-Ø [mm]	Auslass-Ø [mm]
851099N	John Deere	Raupen Dozer / 400-850	750H	0	Denso	10PA17C	146	8	12		16	21
851754N	John Deere	Raupen Dozer / 400-850	750J	0	Denso	10PA17C	146	8	24			
851759N	John Deere	Raupen Dozer / 400-850	755	0	Denso	10PA17C	146	1	24			
851790N	John Deere	Raupen Dozer / 400-850	755B	0		S6	170	1	24			
851759N	John Deere	Raupen Dozer / 400-850	755B	0	Denso	10PA17C	146	1	24			
851759N	John Deere	Raupen Dozer / 400-850	850	0	Denso	10PA17C	146	1	24			
851754N	John Deere	Raupen Dozer / 400-850	850	0	Denso	10PA17C	146	8	24			
851759N	John Deere	Raupen Dozer / 400-850	850B	0	Denso	10PA17C	146	1	24			
851754N	John Deere	Raupen Dozer / 400-850	850J	0	Denso	10PA17C	146	8	24			
852991N	John Deere	Rückezug	1210E	0	Denso	10SRE18C	125	8	24			
852991N	John Deere	Rückezug	1510E	0	Denso	10SRE18C	125	8	24			
851754N	John Deere	Schaufellader / 400-800 Serie	444J	0	Denso	10PA17C	146	8	24			
852991N	John Deere	Schaufellader / 400-800 Serie	444K	0	Denso	10SRE18C	125	8	24			
852991N	John Deere	Schaufellader / 400-800 Serie	524K	0	Denso	10SRE18C	125	8	24			
851755N	John Deere	Schaufellader / 400-800 Serie	544G	0	Denso	10PA17C	146	1	12			
852991N	John Deere	Schaufellader / 400-800 Serie	544K	0	Denso	10SRE18C	125	8	24			
852991N	John Deere	Schaufellader / 400-800 Serie	644K	0	Denso	10SRE18C	125	8	24			
852991N	John Deere	Schaufellader / 400-800 Serie	724K	0	Denso	10SRE18C	125	8	24			
852991N	John Deere	Schaufellader / 400-800 Serie	744K	0	Denso	10SRE18C	125	8	24			
852991N	John Deere	Schaufellader / 400-800 Serie	824K	0	Denso	10SRE18C	125	8	24			
852991N	John Deere	Schaufellader / 400-800 Serie	844K	0	Denso	10SRE18C	125	8	24			
851099N	John Deere	Schaufellader / 400-800 Serie	4890	0	Denso	10PA17C	146	8	12		16	21

Dasis Nr.	Hersteller	Modell	Typ	KW	Herstellereinschränkung	Kompressor-ID	Riemenscheiben-Ø [mm]	Rippenanzahl	Spannung [V]	Zylinderkopf-ID (Kompressor)	Einlass-Ø [mm]	Auslass-Ø [mm]
851099N	John Deere	Schaufellader / 400-800 Serie	4895	0	Denso	10PA17C	146	8	12		16	21
851099N	John Deere	Schaufellader / 400-800 Serie	4990	0	Denso	10PA17C	146	8	12		16	21
851099N	John Deere	Schaufellader / 400-800 Serie	4995	0	Denso	10PA17C	146	8	12		16	21
851754N	John Deere	Schaufellader / 400-800 Serie	T44H	0	Denso	10PA17C	146	8	24			
851754N	John Deere	Schaufellader / 400-800 Serie	T54H	0	Denso	10PA17C	146	8	24			
850409N	John Deere	Schlepper / 300-955	830	0	GM Harrison	A6	139	1	12			
851753N	John Deere	Schlepper / 300-955	830	0	GM Harrison	A6	139	1	12		16	16
850409N	John Deere	Schlepper / 300-955	840	0	GM Harrison	A6	139	1	12			
851753N	John Deere	Schlepper / 300-955	840	0	GM Harrison	A6	139	1	12		16	16
850409N	John Deere	Schlepper / 300-955	930	0	GM Harrison	A6	139	1	12			
851753N	John Deere	Schlepper / 300-955	930	0	GM Harrison	A6	139	1	12		16	16
850409N	John Deere	Schlepper / 300-955	940	0	GM Harrison	A6	139	1	12			
851753N	John Deere	Schlepper / 300-955	940	0	GM Harrison	A6	139	1	12		16	16
850409N	John Deere	Schlepper / 1000-1950	1030	0	GM Harrison	A6	139	1	12			
851753N	John Deere	Schlepper / 1000-1950	1030	0	GM Harrison	A6	139	1	12		16	16
850409N	John Deere	Schlepper / 1000-1950	1040	0	GM Harrison	A6	139	1	12			
851753N	John Deere	Schlepper / 1000-1950	1040	0	GM Harrison	A6	139	1	12		16	16
850409N	John Deere	Schlepper / 1000-1950	1130	0	GM Harrison	A6	139	1	12			
851753N	John Deere	Schlepper / 1000-1950	1130	0	GM Harrison	A6	139	1	12		16	16
850409N	John Deere	Schlepper / 1000-1950	1140	0	GM Harrison	A6	139	1	12			
851753N	John Deere	Schlepper / 1000-1950	1140	0	GM Harrison	A6	139	1	12		16	16

Dasis Nr.	Hersteller	Modell	Typ	KW	Herstellereinschränkung	Kompressor-ID	Riemenscheiben-Ø [mm]	Rippenanzahl	Spannung [V]	Zylinderkopf-ID (Kompressor)	Einlass-Ø [mm]	Auslass-Ø [mm]
850516N	John Deere	Schlepper / 1000-1950	1350	0	Denso	6E171	146	1	12			
850409N	John Deere	Schlepper / 1000-1950	1350	0	GM Harrison	A6	139	1	12			
851753N	John Deere	Schlepper / 1000-1950	1350	0	GM Harrison	A6	139	1	12		16	16
850409N	John Deere	Schlepper / 1000-1950	1530	0	GM Harrison	A6	139	1	12			
851753N	John Deere	Schlepper / 1000-1950	1530	0	GM Harrison	A6	139	1	12		16	16
850516N	John Deere	Schlepper / 1000-1950	1550	0	Denso	6E171	146	1	12			
850409N	John Deere	Schlepper / 1000-1950	1550	0	GM Harrison	A6	139	1	12			
851753N	John Deere	Schlepper / 1000-1950	1550	0	GM Harrison	A6	139	1	12		16	16
850409N	John Deere	Schlepper / 1000-1950	1630	0	GM Harrison	A6	139	1	12			
851753N	John Deere	Schlepper / 1000-1950	1630	0	GM Harrison	A6	139	1	12		16	16
850409N	John Deere	Schlepper / 1000-1950	1640	0	GM Harrison	A6	139	1	12			
851753N	John Deere	Schlepper / 1000-1950	1640	0	GM Harrison	A6	139	1	12		16	16
850516N	John Deere	Schlepper / 1000-1950	1750	0	Denso	6E171	146	1	12			
850409N	John Deere	Schlepper / 1000-1950	1750	0	GM Harrison	A6	139	1	12			
851753N	John Deere	Schlepper / 1000-1950	1750	0	GM Harrison	A6	139	1	12		16	16
850409N	John Deere	Schlepper / 1000-1950	1830	0	GM Harrison	A6	139	1	12			
851753N	John Deere	Schlepper / 1000-1950	1830	0	GM Harrison	A6	139	1	12		16	16
850409N	John Deere	Schlepper / 1000-1950	1840	0	GM Harrison	A6	139	1	12			
851753N	John Deere	Schlepper / 1000-1950	1840	0	GM Harrison	A6	139	1	12		16	16
850516N	John Deere	Schlepper / 1000-1950	1850	0	Denso	6E171	146	1	12			
850409N	John Deere	Schlepper / 1000-1950	1850	0	GM Harrison	A6	139	1	12			

Dasis Nr.	Hersteller	Modell	Typ	KW	Herstellereinschränkung	Kompressor-ID	Riemenscheiben-Ø [mm]	Rippenanzahl	Spannung [V]	Zylinderkopf-ID (Kompressor)	Einlass-Ø [mm]	Auslass-Ø [mm]
851753N	John Deere	Schlepper / 1000-1950	1850	0	GM Harrison	A6	139	1	12		16	16
850516N	John Deere	Schlepper / 1000-1950	1950	0	Denso	6E171	146	1	12			
850409N	John Deere	Schlepper / 1000-1950	1950	0	GM Harrison	A6	139	1	12			
851753N	John Deere	Schlepper / 1000-1950	1950	0	GM Harrison	A6	139	1	12		16	16
850409N	John Deere	Schlepper / 2000-2955	2030	0	GM Harrison	A6	139	1	12			
851753N	John Deere	Schlepper / 2000-2955	2030	0	GM Harrison	A6	139	1	12		16	16
850409N	John Deere	Schlepper / 2000-2955	2040	0	GM Harrison	A6	139	1	12			
851753N	John Deere	Schlepper / 2000-2955	2040	0	GM Harrison	A6	139	1	12		16	16
850409N	John Deere	Schlepper / 2000-2955	2040S	0	GM Harrison	A6	139	1	12			
851753N	John Deere	Schlepper / 2000-2955	2040S	0	GM Harrison	A6	139	1	12		16	16
850409N	John Deere	Schlepper / 2000-2955	2130	0	GM Harrison	A6	139	1	12			
851753N	John Deere	Schlepper / 2000-2955	2130	0	GM Harrison	A6	139	1	12		16	16
850409N	John Deere	Schlepper / 2000-2955	2140	0	GM Harrison	A6	139	1	12			
851753N	John Deere	Schlepper / 2000-2955	2140	0	GM Harrison	A6	139	1	12		16	16
850409N	John Deere	Schlepper / 2000-2955	2240	0	GM Harrison	A6	139	1	12			
851753N	John Deere	Schlepper / 2000-2955	2240	0	GM Harrison	A6	139	1	12		16	16
850516N	John Deere	Schlepper / 2000-2955	2250	0	Denso	6E171	146	1	12			
850409N	John Deere	Schlepper / 2000-2955	2250	0	GM Harrison	A6	139	1	12			
851753N	John Deere	Schlepper / 2000-2955	2250	0	GM Harrison	A6	139	1	12		16	16
850516N	John Deere	Schlepper / 2000-2955	2450	0	Denso	6E171	146	1	12			
851753N	John Deere	Schlepper / 2000-2955	2450	0	GM Harrison	A6	139	1	12		16	16

Dasis Nr.	Hersteller	Modell	Typ	KW	Herstellereinschränkung	Kompressor-ID	Riemenscheiben-Ø [mm]	Rippenanzahl	Spannung [V]	Zylinderkopf-ID (Kompressor)	Einlass-Ø [mm]	Auslass-Ø [mm]
850516N	John Deere	Schlepper / 2000-2955	2550	0	Denso	6E171	146	1	12			
851753N	John Deere	Schlepper / 2000-2955	2550	0	GM Harrison	A6	139	1	12		16	16
850516N	John Deere	Schlepper / 2000-2955	2650	0	Denso	6E171	146	1	12			
851753N	John Deere	Schlepper / 2000-2955	2650	0	GM Harrison	A6	139	1	12		16	16
850516N	John Deere	Schlepper / 2000-2955	2850	0	Denso	6E171	146	1	12			
851753N	John Deere	Schlepper / 2000-2955	2850	0	GM Harrison	A6	139	1	12		16	16
850409N	John Deere	Schlepper / 3000-3650	3030	0	GM Harrison	A6	139	1	12			
851753N	John Deere	Schlepper / 3000-3650	3030	0	GM Harrison	A6	139	1	12		16	16
850409N	John Deere	Schlepper / 3000-3650	3040	0	GM Harrison	A6	139	1	12			
851753N	John Deere	Schlepper / 3000-3650	3040	0	GM Harrison	A6	139	1	12		16	16
850516N	John Deere	Schlepper / 3000-3650	3050	0	Denso	6E171	146	1	12			
851753N	John Deere	Schlepper / 3000-3650	3050	0	GM Harrison	A6	139	1	12		16	16
850409N	John Deere	Schlepper / 3000-3650	3130	0	GM Harrison	A6	139	1	12			
851753N	John Deere	Schlepper / 3000-3650	3130	0	GM Harrison	A6	139	1	12		16	16
850409N	John Deere	Schlepper / 3000-3650	3140	0	GM Harrison	A6	139	1	12			
851753N	John Deere	Schlepper / 3000-3650	3140	0	GM Harrison	A6	139	1	12		16	16
850516N	John Deere	Schlepper / 3000-3650	3150	0	Denso	6E171	146	1	12			
850409N	John Deere	Schlepper / 3000-3650	3150	0	GM Harrison	A6	139	1	12			
851753N	John Deere	Schlepper / 3000-3650	3150	0	GM Harrison	A6	139	1	12		16	16
850409N	John Deere	Schlepper / 3000-3650	3340	0	GM Harrison	A6	139	1	12			
851753N	John Deere	Schlepper / 3000-3650	3340	0	GM Harrison	A6	139	1	12		16	16

Dasis Nr.	Hersteller	Modell	Typ	KW	Herstellereinschränkung	Kompressor-ID	Riemenscheiben-Ø [mm]	Rippenanzahl	Spannung [V]	Zylinderkopf-ID (Kompressor)	Einlass-Ø [mm]	Auslass-Ø [mm]
850516N	John Deere	Schlepper / 3000-3650	3350	0	Denso	6E171	146	1	12			
850409N	John Deere	Schlepper / 3000-3650	3350	0	GM Harrison	A6	139	1	12			
851753N	John Deere	Schlepper / 3000-3650	3350	0	GM Harrison	A6	139	1	12		16	16
851755N	John Deere	Schlepper / 3000-3650	3430	0	Denso	10PA17C	146	1	12			
850409N	John Deere	Schlepper / 3000-3650	3640	0	GM Harrison	A6	139	1	12			
851753N	John Deere	Schlepper / 3000-3650	3640	0	GM Harrison	A6	139	1	12		16	16
850516N	John Deere	Schlepper / 3000-3650	3650	0	Denso	6E171	146	1	12			
850409N	John Deere	Schlepper / 3000-3650	3650	0	GM Harrison	A6	139	1	12			
851753N	John Deere	Schlepper / 3000-3650	3650	0	GM Harrison	A6	139	1	12		16	16
851755N	John Deere	Schlepper / 3000-3650	3830	0	Denso	10PA17C	146	1	12			
850409N	John Deere	Schlepper / 4000-4955	4040	0	GM Harrison	A6	139	1	12			
851753N	John Deere	Schlepper / 4000-4955	4040	0	GM Harrison	A6	139	1	12		16	16
850409N	John Deere	Schlepper / 4000-4955	4040S	0	GM Harrison	A6	139	1	12			
851753N	John Deere	Schlepper / 4000-4955	4040S	0	GM Harrison	A6	139	1	12		16	16
850516N	John Deere	Schlepper / 4000-4955	4050	0	Denso	6E171	146	1	12			
850409N	John Deere	Schlepper / 4000-4955	4050	0	GM Harrison	A6	139	1	12			
851753N	John Deere	Schlepper / 4000-4955	4050	0	GM Harrison	A6	139	1	12		16	16
850516N	John Deere	Schlepper / 4000-4955	4055	0	Denso	6E171	146	1	12			
850409N	John Deere	Schlepper / 4000-4955	4230	0	GM Harrison	A6	139	1	12			
851753N	John Deere	Schlepper / 4000-4955	4230	0	GM Harrison	A6	139	1	12		16	16
850409N	John Deere	Schlepper / 4000-4955	4240	0	GM Harrison	A6	139	1	12			

Dasis Nr.	Hersteller	Modell	Typ	KW	Herstellereinschränkung	Kompressor-ID	Riemenscheiben-Ø [mm]	Rippenanzahl	Spannung [V]	Zylinderkopf-ID (Kompressor)	Einlass-Ø [mm]	Auslass-Ø [mm]
851753N	John Deere	Schlepper / 4000-4955	4240	0	GM Harrison	A6	139	1	12		16	16
850409N	John Deere	Schlepper / 4000-4955	4240S	0	GM Harrison	A6	139	1	12			
851753N	John Deere	Schlepper / 4000-4955	4240S	0	GM Harrison	A6	139	1	12		16	16
850516N	John Deere	Schlepper / 4000-4955	4250	0	Denso	6E171	146	1	12			
850409N	John Deere	Schlepper / 4000-4955	4250	0	GM Harrison	A6	139	1	12			
851753N	John Deere	Schlepper / 4000-4955	4250	0	GM Harrison	A6	139	1	12		16	16
850516N	John Deere	Schlepper / 4000-4955	4255	0	Denso	6E171	146	1	12			
850516N	John Deere	Schlepper / 4000-4955	4350	0	Denso	6E171	146	1	12			
850409N	John Deere	Schlepper / 4000-4955	4350	0	GM Harrison	A6	139	1	12			
851753N	John Deere	Schlepper / 4000-4955	4350	0	GM Harrison	A6	139	1	12		16	16
850409N	John Deere	Schlepper / 4000-4955	4430	0	GM Harrison	A6	139	1	12			
851753N	John Deere	Schlepper / 4000-4955	4430	0	GM Harrison	A6	139	1	12		16	16
850409N	John Deere	Schlepper / 4000-4955	4440	0	GM Harrison	A6	139	1	12			
851753N	John Deere	Schlepper / 4000-4955	4440	0	GM Harrison	A6	139	1	12		16	16
850516N	John Deere	Schlepper / 4000-4955	4450	0	Denso	6E171	146	1	12			
850409N	John Deere	Schlepper / 4000-4955	4450	0	GM Harrison	A6	139	1	12			
851753N	John Deere	Schlepper / 4000-4955	4450	0	GM Harrison	A6	139	1	12		16	16
850516N	John Deere	Schlepper / 4000-4955	4455	0	Denso	6E171	146	1	12			
850516N	John Deere	Schlepper / 4000-4955	4555	0	Denso	6E171	146	1	12			
850409N	John Deere	Schlepper / 4000-4955	4630	0	GM Harrison	A6	139	1	12			
851753N	John Deere	Schlepper / 4000-4955	4630	0	GM Harrison	A6	139	1	12		16	16

Dasis Nr.	Hersteller	Modell	Typ	KW	Herstellereinschränkung	Kompressor-ID	Riemenscheiben-Ø [mm]	Rippenanzahl	Spannung [V]	Zylinderkopf-ID (Kompressor)	Einlass-Ø [mm]	Auslass-Ø [mm]
850409N	John Deere	Schlepper / 4000-4955	4640	0	GM Harrison	A6	139	1	12			
851753N	John Deere	Schlepper / 4000-4955	4640	0	GM Harrison	A6	139	1	12		16	16
850516N	John Deere	Schlepper / 4000-4955	4650	0	Denso	6E171	146	1	12			
850409N	John Deere	Schlepper / 4000-4955	4650	0	GM Harrison	A6	139	1	12			
851753N	John Deere	Schlepper / 4000-4955	4650	0	GM Harrison	A6	139	1	12		16	16
850516N	John Deere	Schlepper / 4000-4955	4755	0	Denso	6E171	146	1	12			
850409N	John Deere	Schlepper / 4000-4955	4840	0	GM Harrison	A6	139	1	12			
851753N	John Deere	Schlepper / 4000-4955	4840	0	GM Harrison	A6	139	1	12		16	16
850516N	John Deere	Schlepper / 4000-4955	4850	0	Denso	6E171	146	1	12			
850409N	John Deere	Schlepper / 4000-4955	4850	0	GM Harrison	A6	139	1	12			
851753N	John Deere	Schlepper / 4000-4955	4850	0	GM Harrison	A6	139	1	12		16	16
850516N	John Deere	Schlepper / 4000-4955	4955	0	Denso	6E171	146	1	12			
852648N	John Deere	Schlepper / 5000-5820	5000M	0	Denso	10PA17C	124	6	12			
852648N	John Deere	Schlepper / 5000-5820	5025	0	Denso	10PA17C	124	6	12			
852995N	John Deere	Schlepper / 5000-5820	5065	0	Denso	10SRE18C	125	8	12		15	17
852648N	John Deere	Schlepper / 5000-5820	5065M	0	Denso	10PA17C	124	6	12			
850945N	John Deere	Schlepper / 5000-5820	5065M	0	Denso	10PA17C	132	6				
852648N	John Deere	Schlepper / 5000-5820	5075M	0	Denso	10PA17C	124	6	12			
850945N	John Deere	Schlepper / 5000-5820	5075M	0	Denso	10PA17C	132	6				
850956N	John Deere	Schlepper / 5000-5820	5080R/N	0	Denso	10PA15C	125	8	12		ohne	ohne
852995N	John Deere	Schlepper / 5000-5820	5083EN	0	Denso	10SRE18C	125	8	12		15	17



Dasis Nr.	Hersteller	Modell	Typ	KW	Herstellereinschränkung	Kompressor-ID	Riemenscheiben-Ø [mm]	Rippenanzahl	Spannung [V]	Zylinderkopf-ID (Kompressor)	Einlass-Ø [mm]	Auslass-Ø [mm]
852648N	John Deere	Schlepper / 5000-5820	5085M	0	Denso	10PA17C	124	6	12			
850945N	John Deere	Schlepper / 5000-5820	5085M	0	Denso	10PA17C	132	6				
852995N	John Deere	Schlepper / 5000-5820	5085M	0	Denso	10SRE18C	125	8	12		15	17
850956N	John Deere	Schlepper / 5000-5820	5090R/N	0	Denso	10PA15C	125	8	12		ohne	ohne
852995N	John Deere	Schlepper / 5000-5820	5093EN	0	Denso	10SRE18C	125	8	12		15	17
852648N	John Deere	Schlepper / 5000-5820	5095M	0	Denso	10PA17C	124	6	12			
850945N	John Deere	Schlepper / 5000-5820	5095M	0	Denso	10PA17C	132	6				
852995N	John Deere	Schlepper / 5000-5820	5095M	0	Denso	10SRE18C	125	8	12		15	17
852648N	John Deere	Schlepper / 5000-5820	5095MH	0	Denso	10PA17C	124	6	12			
850945N	John Deere	Schlepper / 5000-5820	5095MH	0	Denso	10PA17C	132	6				
852995N	John Deere	Schlepper / 5000-5820	5100E	0	Denso	10SRE18C	125	8	12		15	17
852995N	John Deere	Schlepper / 5000-5820	5100M	0	Denso	10SRE18C	125	8	12		15	17
852995N	John Deere	Schlepper / 5000-5820	5100MH	0	Denso	10SRE18C	125	8	12		15	17
850956N	John Deere	Schlepper / 5000-5820	5100R/N	0	Denso	10PA15C	125	8	12		ohne	ohne
852995N	John Deere	Schlepper / 5000-5820	5101E	0	Denso	10SRE18C	125	8	12		15	17
852995N	John Deere	Schlepper / 5000-5820	5101EN	0	Denso	10SRE18C	125	8	12		15	17
852648N	John Deere	Schlepper / 5000-5820	5105M	0	Denso	10PA17C	124	6	12			
850945N	John Deere	Schlepper / 5000-5820	5105M	0	Denso	10PA17C	132	6				
852995N	John Deere	Schlepper / 5000-5820	5105M	0	Denso	10SRE18C	125	8	12		15	17
852995N	John Deere	Schlepper / 5000-5820	5115M	0	Denso	10SRE18C	125	8	12		15	17
851761N	John Deere	Schlepper / 5000-5820	5200	0	Denso	10PA17C	146	1	12			

Dasis Nr.	Hersteller	Modell	Typ	KW	Herstellereinschränkung	Kompressor-ID	Riemenscheiben-Ø [mm]	Rippenanzahl	Spannung [V]	Zylinderkopf-ID (Kompressor)	Einlass-Ø [mm]	Auslass-Ø [mm]
851099N	John Deere	Schlepper / 5000-5820	5220	0	Denso	10PA17C	146	8	12		16	21
852648N	John Deere	Schlepper / 5000-5820	5225	0	Denso	10PA17C	124	6	12			
850945N	John Deere	Schlepper / 5000-5820	5225	0	Denso	10PA17C	132	6				
851761N	John Deere	Schlepper / 5000-5820	5300	0	Denso	10PA17C	146	1	12			
851761N	John Deere	Schlepper / 5000-5820	5310	0	Denso	10PA17C	146	1	12			
851099N	John Deere	Schlepper / 5000-5820	5320	0	Denso	10PA17C	146	8	12		16	21
852648N	John Deere	Schlepper / 5000-5820	5325	0	Denso	10PA17C	124	6	12			
850945N	John Deere	Schlepper / 5000-5820	5325	0	Denso	10PA17C	132	6				
851761N	John Deere	Schlepper / 5000-5820	5400	0	Denso	10PA17C	146	1	12			
851761N	John Deere	Schlepper / 5000-5820	5410	0	Denso	10PA17C	146	1	12			
851099N	John Deere	Schlepper / 5000-5820	5420	0	Denso	10PA17C	146	8	12		16	21
852648N	John Deere	Schlepper / 5000-5820	5425	0	Denso	10PA17C	124	6	12			
850945N	John Deere	Schlepper / 5000-5820	5425	0	Denso	10PA17C	132	6				
851761N	John Deere	Schlepper / 5000-5820	5500	0	Denso	10PA17C	146	1	12			
851761N	John Deere	Schlepper / 5000-5820	5510	0	Denso	10PA17C	146	1	12			
851099N	John Deere	Schlepper / 5000-5820	5520	0	Denso	10PA17C	146	8	12		16	21
852648N	John Deere	Schlepper / 5000-5820	5525	0	Denso	10PA17C	124	6	12			
850945N	John Deere	Schlepper / 5000-5820	5525	0	Denso	10PA17C	132	6				
850956N	John Deere	Schlepper / 5000-5820	5620	0	Denso	10PA15C	125	8	12		ohne	ohne
852648N	John Deere	Schlepper / 5000-5820	5625	0	Denso	10PA17C	124	6	12			
850945N	John Deere	Schlepper / 5000-5820	5625	0	Denso	10PA17C	132	6				

Dasis Nr.	Hersteller	Modell	Typ	KW	Herstellereinschränkung	Kompressor-ID	Riemenscheiben-Ø [mm]	Rippenanzahl	Spannung [V]	Zylinderkopf-ID (Kompressor)	Einlass-Ø [mm]	Auslass-Ø [mm]
850956N	John Deere	Schlepper / 5000-5820	5720	0	Denso	10PA15C	125	8	12		ohne	ohne
850340N	John Deere	Schlepper / 6000-6930	6010	0	Denso	10PA15C	125	8	12			
850340N	John Deere	Schlepper / 6000-6930	6020	0	Denso	10PA15C	125	8	12			
852995N	John Deere	Schlepper / 6000-6930	6090RC	0	Denso	10SRE18C	125	8	12		15	17
850340N	John Deere	Schlepper / 6000-6930	6100	0	Denso	10PA15C	125	8	12			
851755N	John Deere	Schlepper / 6000-6930	6100	0	Denso	10PA17C	146	1	12			
852995N	John Deere	Schlepper / 6000-6930	6100MC	0	Denso	10SRE18C	125	8	12		15	17
852995N	John Deere	Schlepper / 6000-6930	6100RC	0	Denso	10SRE18C	125	8	12		15	17
852995N	John Deere	Schlepper / 6000-6930	6105D	0	Denso	10SRE18C	125	8	12		15	17
852995N	John Deere	Schlepper / 6000-6930	6105M	0	Denso	10SRE18C	125	8	12		15	17
852995N	John Deere	Schlepper / 6000-6930	6105R	0	Denso	10SRE18C	125	8	12		15	17
850340N	John Deere	Schlepper / 6000-6930	6110	0	Denso	10PA15C	125	8	12			
852995N	John Deere	Schlepper / 6000-6930	6110RC	0	Denso	10SRE18C	125	8	12		15	17
852995N	John Deere	Schlepper / 6000-6930	6115D	0	Denso	10SRE18C	125	8	12		15	17
852995N	John Deere	Schlepper / 6000-6930	6115M	0	Denso	10SRE18C	125	8	12		15	17
852995N	John Deere	Schlepper / 6000-6930	6115R	0	Denso	10SRE18C	125	8	12		15	17
850340N	John Deere	Schlepper / 6000-6930	6120	0	Denso	10PA15C	125	8	12			
852995N	John Deere	Schlepper / 6000-6930	6125M	0	Denso	10SRE18C	125	8	12		15	17
852995N	John Deere	Schlepper / 6000-6930	6125R	0	Denso	10SRE18C	125	8	12		15	17
850956N	John Deere	Schlepper / 6000-6930	6130	0	Denso	10PA15C	125	8	12		ohne	ohne
852995N	John Deere	Schlepper / 6000-6930	6130M	0	Denso	10SRE18C	125	8	12		15	17

Dasis Nr.	Hersteller	Modell	Typ	KW	Herstellereinschränkung	Kompressor-ID	Riemenscheiben-Ø [mm]	Rippenanzahl	Spannung [V]	Zylinderkopf-ID (Kompressor)	Einlass-Ø [mm]	Auslass-Ø [mm]
852995N	John Deere	Schlepper / 6000-6930	6130R	0	Denso	10SRE18C	125	8	12		15	17
852995N	John Deere	Schlepper / 6000-6930	6140D	0	Denso	10SRE18C	125	8	12		15	17
852995N	John Deere	Schlepper / 6000-6930	6140M	0	Denso	10SRE18C	125	8	12		15	17
852995N	John Deere	Schlepper / 6000-6930	6140R	0	Denso	10SRE18C	125	8	12		15	17
852995N	John Deere	Schlepper / 6000-6930	6150M	0	Denso	10SRE18C	125	8	12		15	17
852995N	John Deere	Schlepper / 6000-6930	6150R	0	Denso	10SRE18C	125	8	12		15	17
852995N	John Deere	Schlepper / 6000-6930	6170M	0	Denso	10SRE18C	125	8	12		15	17
852995N	John Deere	Schlepper / 6000-6930	6170R	0	Denso	10SRE18C	125	8	12		15	17
852995N	John Deere	Schlepper / 6000-6930	6190R	0	Denso	10SRE18C	125	8	12		15	17
850340N	John Deere	Schlepper / 6000-6930	6200	0	Denso	10PA15C	125	8	12			
850340N	John Deere	Schlepper / 6000-6930	6210	0	Denso	10PA15C	125	8	12			
852995N	John Deere	Schlepper / 6000-6930	6210R	0	Denso	10SRE18C	125	8	12		15	17
850340N	John Deere	Schlepper / 6000-6930	6220	0	Denso	10PA15C	125	8	12			
850956N	John Deere	Schlepper / 6000-6930	6230	0	Denso	10PA15C	125	8	12		ohne	ohne
850340N	John Deere	Schlepper / 6000-6930	6300	0	Denso	10PA15C	125	8	12			
850340N	John Deere	Schlepper / 6000-6930	6310	0	Denso	10PA15C	125	8	12			
850340N	John Deere	Schlepper / 6000-6930	6320	0	Denso	10PA15C	125	8	12			
850956N	John Deere	Schlepper / 6000-6930	6330	0	Denso	10PA15C	125	8	12		ohne	ohne
850340N	John Deere	Schlepper / 6000-6930	6400	0	Denso	10PA15C	125	8	12			
850340N	John Deere	Schlepper / 6000-6930	6410	0	Denso	10PA15C	125	8	12			
850340N	John Deere	Schlepper / 6000-6930	6420	0	Denso	10PA15C	125	8	12			

Dasis Nr.	Hersteller	Modell	Typ	KW	Herstellereinschränkung	Kompressor-ID	Riemenscheiben-Ø [mm]	Rippenanzahl	Spannung [V]	Zylinderkopf-ID (Kompressor)	Einlass-Ø [mm]	Auslass-Ø [mm]
850340N	John Deere	Schlepper / 6000-6930	6420S	0	Denso	10PA15C	125	8	12			
850956N	John Deere	Schlepper / 6000-6930	6430	0	Denso	10PA15C	125	8	12		ohne	ohne
850956N	John Deere	Schlepper / 6000-6930	6430PR	0	Denso	10PA15C	125	8	12		ohne	ohne
851755N	John Deere	Schlepper / 6000-6930	6500	0	Denso	10PA17C	146	1	12			
850340N	John Deere	Schlepper / 6000-6930	6506	0	Denso	10PA15C	125	8	12			
850340N	John Deere	Schlepper / 6000-6930	6510	0	Denso	10PA15C	125	8	12			
850340N	John Deere	Schlepper / 6000-6930	6520	0	Denso	10PA15C	125	8	12			
850956N	John Deere	Schlepper / 6000-6930	6530	0	Denso	10PA15C	125	8	12		ohne	ohne
850340N	John Deere	Schlepper / 6000-6930	6600	0	Denso	10PA15C	125	8	12			
851755N	John Deere	Schlepper / 6000-6930	6600	0	Denso	10PA17C	146	1	12			
850340N	John Deere	Schlepper / 6000-6930	6610	0	Denso	10PA15C	125	8	12			
850340N	John Deere	Schlepper / 6000-6930	6620	0	Denso	10PA15C	125	8	12			
850956N	John Deere	Schlepper / 6000-6930	6630	0	Denso	10PA15C	125	8	12		ohne	ohne
850956N	John Deere	Schlepper / 6000-6930	6630PR	0	Denso	10PA15C	125	8	12		ohne	ohne
850956N	John Deere	Schlepper / 6000-6930	6633	0	Denso	10PA15C	125	8	12		ohne	ohne
851755N	John Deere	Schlepper / 6000-6930	6700	0	Denso	10PA17C	146	1	12			
850340N	John Deere	Schlepper / 6000-6930	6800	0	Denso	10PA15C	125	8	12			
850340N	John Deere	Schlepper / 6000-6930	6810	0	Denso	10PA15C	125	8	12			
850340N	John Deere	Schlepper / 6000-6930	6820	0	Denso	10PA15C	125	8	12			
850956N	John Deere	Schlepper / 6000-6930	6830	0	Denso	10PA15C	125	8	12		ohne	ohne
850956N	John Deere	Schlepper / 6000-6930	6830PR	0	Denso	10PA15C	125	8	12		ohne	ohne

Dasis Nr.	Hersteller	Modell	Typ	KW	Herstellereinschränkung	Kompressor-ID	Riemenscheiben-Ø [mm]	Rippenanzahl	Spannung [V]	Zylinderkopf-ID (Kompressor)	Einlass-Ø [mm]	Auslass-Ø [mm]
850340N	John Deere	Schlepper / 6000-6930	6900	0	Denso	10PA15C	125	8	12			
850340N	John Deere	Schlepper / 6000-6930	6910	0	Denso	10PA15C	125	8	12			
850340N	John Deere	Schlepper / 6000-6930	6910S	0	Denso	10PA15C	125	8	12			
850340N	John Deere	Schlepper / 6000-6930	6920	0	Denso	10PA15C	125	8	12			
850340N	John Deere	Schlepper / 6000-6930	6920S	0	Denso	10PA15C	125	8	12			
850956N	John Deere	Schlepper / 6000-6930	6930	0	Denso	10PA15C	125	8	12		ohne	ohne
850956N	John Deere	Schlepper / 6000-6930	6930PR	0	Denso	10PA15C	125	8	12		ohne	ohne
850956N	John Deere	Schlepper / 7000-7920	7130	0	Denso	10PA15C	125	8	12		ohne	ohne
850956N	John Deere	Schlepper / 7000-7920	7230	0	Denso	10PA15C	125	8	12		ohne	ohne
850956N	John Deere	Schlepper / 7000-7920	7330	0	Denso	10PA15C	125	8	12		ohne	ohne
850956N	John Deere	Schlepper / 7000-7920	7430	0	Denso	10PA15C	125	8	12		ohne	ohne
850956N	John Deere	Schlepper / 7000-7920	7530	0	Denso	10PA15C	125	8	12		ohne	ohne
851099N	John Deere	Schlepper / 7000-7920	7600	0	Denso	10PA17C	146	8	12		16	21
851099N	John Deere	Schlepper / 7000-7920	7610	0	Denso	10PA17C	146	8	12		16	21
851099N	John Deere	Schlepper / 7000-7920	7700	0	Denso	10PA17C	146	8	12		16	21
851099N	John Deere	Schlepper / 7000-7920	7710	0	Denso	10PA17C	146	8	12		16	21
851099N	John Deere	Schlepper / 7000-7920	7800	0	Denso	10PA17C	146	8	12		16	21
851099N	John Deere	Schlepper / 7000-7920	7810	0	Denso	10PA17C	146	8	12		16	21
851099N	John Deere	Schlepper / 8000-8640	8100	0	Denso	10PA17C	146	8	12		16	21
851099N	John Deere	Schlepper / 8000-8640	8110	0	Denso	10PA17C	146	8	12		16	21
851099N	John Deere	Schlepper / 8000-8640	8130	0	Denso	10PA17C	146	8	12		16	21

Dasis Nr.	Hersteller	Modell	Typ	KW	Herstellereinschränkung	Kompressor-ID	Riemenscheiben-Ø [mm]	Rippenanzahl	Spannung [V]	Zylinderkopf-ID (Kompressor)	Einlass-Ø [mm]	Auslass-Ø [mm]
851099N	John Deere	Schlepper / 8000-8640	8200	0	Denso	10PA17C	146	8	12		16	21
851099N	John Deere	Schlepper / 8000-8640	8210	0	Denso	10PA17C	146	8	12		16	21
851099N	John Deere	Schlepper / 8000-8640	8230	0	Denso	10PA17C	146	8	12		16	21
851099N	John Deere	Schlepper / 8000-8640	8300	0	Denso	10PA17C	146	8	12		16	21
851099N	John Deere	Schlepper / 8000-8640	8310	0	Denso	10PA17C	146	8	12		16	21
851099N	John Deere	Schlepper / 8000-8640	8330	0	Denso	10PA17C	146	8	12		16	21
851099N	John Deere	Schlepper / 8000-8640	8400	0	Denso	10PA17C	146	8	12		16	21
851099N	John Deere	Schlepper / 8000-8640	8410	0	Denso	10PA17C	146	8	12		16	21
850409N	John Deere	Schlepper / 8000-8640	8430	0	GM Harrison	A6	139	1	12			
851753N	John Deere	Schlepper / 8000-8640	8430	0	GM Harrison	A6	139	1	12		16	16
850409N	John Deere	Schlepper / 8000-8640	8440	0	GM Harrison	A6	139	1	12			
851753N	John Deere	Schlepper / 8000-8640	8440	0	GM Harrison	A6	139	1	12		16	16
850956N	John Deere	Schlepper / 8000-8640	8520	0	Denso	10PA15C	125	8	12		ohne	ohne
851099N	John Deere	Schlepper / 8000-8640	8530	0	Denso	10PA17C	146	8	12		16	21
851755N	John Deere	Schlepper / 8000-8640	8570	0	Denso	10PA17C	146	1	12			
850409N	John Deere	Schlepper / 8000-8640	8640	0	GM Harrison	A6	139	1	12			
851753N	John Deere	Schlepper / 8000-8640	8640	0	GM Harrison	A6	139	1	12		16	16
851099N	John Deere	Schlepper / 9000-9620	9100	0	Denso	10PA17C	146	8	12		16	21
851099N	John Deere	Schlepper / 9000-9620	9200	0	Denso	10PA17C	146	8	12		16	21
851099N	John Deere	Schlepper / 9000-9620	9300	0	Denso	10PA17C	146	8	12		16	21
851099N	John Deere	Schlepper / 9000-9620	9400	0	Denso	10PA17C	146	8	12		16	21

Dasis Nr.	Hersteller	Modell	Typ	KW	Herstellereinschränkung	Kompressor-ID	Riemenscheiben-Ø [mm]	Rippenanzahl	Spannung [V]	Zylinderkopf-ID (Kompressor)	Einlass-Ø [mm]	Auslass-Ø [mm]
852995N	John Deere	Schlepper / 9000-9620	9410R	0	Denso	10SRE18C	125	8	12		15	17
852995N	John Deere	Schlepper / 9000-9620	9460RT	0	Denso	10SRE18C	125	8	12		15	17
852995N	John Deere	Schlepper / 9000-9620	9510R	0	Denso	10SRE18C	125	8	12		15	17
852995N	John Deere	Schlepper / 9000-9620	9510RT	0	Denso	10SRE18C	125	8	12		15	17
852995N	John Deere	Schlepper / 9000-9620	9560R	0	Denso	10SRE18C	125	8	12		15	17
852995N	John Deere	Schlepper / 9000-9620	9560RT	0	Denso	10SRE18C	125	8	12		15	17
851755N	John Deere	Schlepper / CTS	CTS II	0	Denso	10PA17C	146	1	12			
851753N	John Deere	Schlepper / CTS	CTS II	0	GM Harrison	A6	139	1	12		16	16
850421N	John Deere	Schlepper / CTS	CTS II	0	York	F209/210R			12		14	11,9
851098N	John Deere	Schlepper Wein Obst / 5000N-9620	5215F	0	Harrison	HR6	132	1	12			
851098N	John Deere	Schlepper Wein Obst / 5000N-9620	5215V	0	Harrison	HR6	132	1	12			
851098N	John Deere	Schlepper Wein Obst / 5000N-9620	5300	0	Harrison	HR6	132	1	12			
851098N	John Deere	Schlepper Wein Obst / 5000N-9620	5310	0	Harrison	HR6	132	1	12			
851098N	John Deere	Schlepper Wein Obst / 5000N-9620	5315F	0	Harrison	HR6	132	1	12			
851098N	John Deere	Schlepper Wein Obst / 5000N-9620	5315V	0	Harrison	HR6	132	1	12			
851098N	John Deere	Schlepper Wein Obst / 5000N-9620	5400	0	Harrison	HR6	132	1	12			
851098N	John Deere	Schlepper Wein Obst / 5000N-9620	5410	0	Harrison	HR6	132	1	12			
851784N	John Deere	Schlepper Wein Obst / 5000N-9620	5415	0	Harrison	HR6	120	8	12		16	16



Dasis Nr.	Hersteller	Modell	Typ	KW	Herstellereinschränkung	Kompressor-ID	Riemenscheiben-Ø [mm]	Rippenanzahl	Spannung [V]	Zylinderkopf-ID (Kompressor)	Einlass-Ø [mm]	Auslass-Ø [mm]
851784N	John Deere	Schlepper Wein Obst / 5000N-9620	5420	0	Harrison	HR6	120	8	12		16	16
851098N	John Deere	Schlepper Wein Obst / 5000N-9620	5500	0	Harrison	HR6	132	1	12			
851784N	John Deere	Schlepper Wein Obst / 5000N-9620	5510	0	Harrison	HR6	120	8	12		16	16
851784N	John Deere	Schlepper Wein Obst / 5000N-9620	5515	0	Harrison	HR6	120	8	12		16	16
851784N	John Deere	Schlepper Wein Obst / 5000N-9620	5515F	0	Harrison	HR6	120	8	12		16	16
851784N	John Deere	Schlepper Wein Obst / 5000N-9620	5515V	0	Harrison	HR6	120	8	12		16	16
851784N	John Deere	Schlepper Wein Obst / 5000N-9620	5520	0	Harrison	HR6	120	8	12		16	16
851784N	John Deere	Schlepper Wein Obst / 5000N-9620	5615F	0	Harrison	HR6	120	8	12		16	16
851784N	John Deere	Schlepper Wein Obst / 5000N-9620	5615V	0	Harrison	HR6	120	8	12		16	16
851099N	John Deere	Schlepper Wein Obst / 5000N-9620	9120	0	Denso	10PA17C	146	8	12		16	21
851099N	John Deere	Schlepper Wein Obst / 5000N-9620	9220	0	Denso	10PA17C	146	8	12		16	21
851099N	John Deere	Schlepper Wein Obst / 5000N-9620	9320	0	Denso	10PA17C	146	8	12		16	21
851099N	John Deere	Schlepper Wein Obst / 5000N-9620	9420	0	Denso	10PA17C	146	8	12		16	21
851099N	John Deere	Schlepper Wein Obst / 5000N-9620	9520	0	Denso	10PA17C	146	8	12		16	21

Dasis Nr.	Hersteller	Modell	Typ	KW	Herstellereinschränkung	Kompressor-ID	Riemenscheiben-Ø [mm]	Rippenanzahl	Spannung [V]	Zylinderkopf-ID (Kompressor)	Einlass-Ø [mm]	Auslass-Ø [mm]
851099N	John Deere	Schlepper Wein Obst / 5000N-9620	9620	0	Denso	10PA17C	146	8	12		16	21
851754N	John Deere	Schürfzüge / 800	872	0	Denso	10PA17C	146	8	24			
851099N	John Deere	Selbstfahrende Feldspritze	4700	0	Denso	10PA17C	146	8	12		16	21
851099N	John Deere	Selbstfahrende Feldspritze	4710	0	Denso	10PA17C	146	8	12		16	21
851099N	John Deere	Selbstfahrende Feldspritze	4920	0	Denso	10PA17C	146	8	12		16	21
851099N	John Deere	Selbstfahrende Feldspritze	4930	0	Denso	10PA17C	146	8	12		16	21
850863N	John Deere	Selbstfahrende Feldspritze	5440	0	Denso	10PA15C	135	2	12			
850516N	John Deere	Selbstfahrende Feldspritze	6000	0	Denso	6E171	146	1	12			
851755N	John Deere	Selbstfahrende Feldspritze	6100	0	Denso	10PA17C	146	1	12			
850516N	John Deere	Selbstfahrende Feldspritze	6500	0	Denso	6E171	146	1	12			
851755N	John Deere	Selbstfahrende Feldspritze	6500	0	Denso	10PA17C	146	1	12			
851755N	John Deere	Selbstfahrende Feldspritze	6600	0	Denso	10PA17C	146	1	12			
850516N	John Deere	Selbstfahrende Feldspritze	6700	0	Denso	6E171	146	1	12			
851755N	John Deere	Selbstfahrende Feldspritze	6700	0	Denso	10PA17C	146	1	12			
850863N	John Deere	Selbstfahrende Feldspritze	7200	0	Denso	10PA15C	135	2	12			
850863N	John Deere	Selbstfahrende Feldspritze	7300	0	Denso	10PA15C	135	2	12			
850863N	John Deere	Selbstfahrende Feldspritze	7400	0	Denso	10PA15C	135	2	12			
850863N	John Deere	Selbstfahrende Feldspritze	7500	0	Denso	10PA15C	135	2	12			
850863N	John Deere	Selbstfahrende Feldspritze	7700	0	Denso	10PA15C	135	2	12			
850863N	John Deere	Selbstfahrende Feldspritze	7800	0	Denso	10PA15C	135	2	12			
851753N	John Deere	Selbstfahrende Schwadmäher / 2200-6670	2250	0	GM Harrison	A6	139	1	12		16	16

Dasis Nr.	Hersteller	Modell	Typ	KW	Herstellereinschränkung	Kompressor-ID	Riemenscheiben-Ø [mm]	Rippenanzahl	Spannung [V]	Zylinderkopf-ID (Kompressor)	Einlass-Ø [mm]	Auslass-Ø [mm]
850409N	John Deere	Selbstfahrende Schwadmäher / 2200-6670	2270	0	GM Harrison	A6	139	1	12			
851753N	John Deere	Selbstfahrende Schwadmäher / 2200-6670	2270	0	GM Harrison	A6	139	1	12		16	16
850409N	John Deere	Selbstfahrende Schwadmäher / 2200-6670	2280	0	GM Harrison	A6	139	1	12			
851753N	John Deere	Selbstfahrende Schwadmäher / 2200-6670	2280	0	GM Harrison	A6	139	1	12		16	16
850409N	John Deere	Selbstfahrende Schwadmäher / 2200-6670	2320	0	GM Harrison	A6	139	1	12			
851753N	John Deere	Selbstfahrende Schwadmäher / 2200-6670	2320	0	GM Harrison	A6	139	1	12		16	16
858485N	John Deere	Selbstfahrende Schwadmäher / 2200-6670	2360	0	Sanden	SD5H14	132	2	12	B		
850409N	John Deere	Selbstfahrende Schwadmäher / 2200-6670	2420	0	GM Harrison	A6	139	1	12			
851753N	John Deere	Selbstfahrende Schwadmäher / 2200-6670	2420	0	GM Harrison	A6	139	1	12		16	16
850516N	John Deere	Selbstfahrende Schwadmäher / 2200-6670	3430	0	Denso	6E171	146	1	12			
851755N	John Deere	Selbstfahrende Schwadmäher / 2200-6670	3430	0	Denso	10PA17C	146	1	12			
851099N	John Deere	Selbstfahrende Schwadmäher / 2200-6670	3430	0	Denso	10PA17C	146	8	12		16	21
850516N	John Deere	Selbstfahrende Schwadmäher / 2200-6670	3830	0	Denso	6E171	146	1	12			
851755N	John Deere	Selbstfahrende Schwadmäher / 2200-6670	3830	0	Denso	10PA17C	146	1	12			

Dasis Nr.	Hersteller	Modell	Typ	KW	Herstellereinschränkung	Kompressor-ID	Riemenscheiben-Ø [mm]	Rippenanzahl	Spannung [V]	Zylinderkopf-ID (Kompressor)	Einlass-Ø [mm]	Auslass-Ø [mm]
851099N	John Deere	Selbstfahrende Schwadmäher / 2200-6670	3830	0	Denso	10PA17C	146	8	12		16	21
851755N	John Deere	Selbstfahrende Schwadmäher / 2200-6670	6670	0	Denso	10PA17C	146	1	12			
851099N	John Deere	Selbstfahrende Schwadmäher / 2200-6670	6670	0	Denso	10PA17C	146	8	12		16	21
850340N	John Deere	Teleskoplader / 3200-3400	3200	0	Denso	10PA15C	125	8	12			
850340N	John Deere	Teleskoplader / 3200-3400	3215	0	Denso	10PA15C	125	8	12			
850340N	John Deere	Teleskoplader / 3200-3400	3220	0	Denso	10PA15C	125	8	12			
851755N	John Deere	Teleskoplader / CTS	CTS	0	Denso	10PA17C	146	1	12			
852843N	Kioti	Traktor DK	35	0	Delphi	SP10	125	1	12			
852843N	Kioti	Traktor DK	45	0	Delphi	SP10	125	1	12			
852843N	Kioti	Traktor DK	50	0	Delphi	SP10	125	1	12			
852843N	Kioti	Traktor RX	6010	0	Delphi	SP10	125	1	12			
851777N	Kobelco	Kettenbagger / Sk	135	0	Sanden	SD7H13	146	1	24		18,3	15,5
851777N	Kobelco	Kettenbagger / SKSR	200	0	Sanden	SD7H13	146	1	24		18,3	15,5
851777N	Kobelco	Kettenbagger / SKSR	235	0	Sanden	SD7H13	146	1	24		18,3	15,5
851777N	Kobelco	Kettenbagger / SKUR	130	0	Sanden	SD7H13	146	1	24		18,3	15,5
851775N	Kobelco	Schauffellader	Sonstige	0	Zexel	DKV14C	115	1	24			
851776N	Kobelco	Schlepper	Sonstige	0	Denso	10S15C	152	1	24		15	18
851781N	Kobelco	Schlepper	Sonstige	0	Zexel	DKS15CH	138	1	24			
851783N	Kobelco	Schlepper	Sonstige	0	Zexel	DKS15CH	139	1	24			
851782N	Kobelco	Schlepper	Sonstige	0	Zexel	DKS15CH	139	1	24		11	15
851766N	Komatsu	Muldenkipper / 65	65	0	Denso	10PA15C	152	1	24			
852742N	Komatsu	Muldenkipper / HD	325-6	0			140	1			15	12
851766N	Komatsu	Muldenkipper / HD	325-6	0	Denso	10PA15C	152	1	24			

Dasis Nr.	Hersteller	Modell	Typ	KW	Herstellereinschränkung	Kompressor-ID	Riemenscheiben-Ø [mm]	Rippenanzahl	Spannung [V]	Zylinderkopf-ID (Kompressor)	Einlass-Ø [mm]	Auslass-Ø [mm]
852742N	Komatsu	Muldenkipper / HD	785-7	0			140	1			15	12
852742N	Komatsu	Muldenkipper / HM	Diverse	0			140	1			15	12
851766N	Komatsu	Raupen Dozer / D	41E	0	Denso	10PA15C	152	1	24			
851747N	Komatsu	Raupen Dozer / D	155-1	0	Seltec	TM-15HD	135	2	24			
851747N	Komatsu	Raupen Dozer / D	355A-3	0	Seltec	TM-15HD	135	2	24			
852742N	Komatsu	Schaufellader / WA	500-6	0			140	1			15	12
851766N	Komatsu	Schaufellader / WA	600-3L	0	Denso	10PA15C	152	1	24			
851752N	Komatsu	Schlepper	SonstigeModelle	0			160	1	24			
851776N	Komatsu	Schlepper	SonstigeModelle	0	Denso	10S15C	152	1	24		15	18
851098N	Komatsu	Schlepper	SonstigeModelle	0	Harrison	HR6	132	1	12			
851727N	Komatsu	Schlepper	SonstigeModelle	0	Sanden	SD5H14	132	2	24	B	16	19
851608N	Komatsu	Schlepper	SonstigeModelle	0	Sanden	SD510		2	24			
851743N	Komatsu	Schlepper	SonstigeModelle	0	Sanden	SD510	165	1	24			
851747N	Komatsu	Schlepper	SonstigeModelle	0	Seltec	TM-15HD	135	2	24			
851779N	Komatsu	Schlepper	SonstigeModelle	0	Tecumseh	HG850-1000						
850352N	Komatsu	Schlepper	SonstigeModelle	0	York	T209/210L					14,9	14,9
851781N	Komatsu	Schlepper	SonstigeModelle	0	Zexel	DKS15CH	138	1	24			
851783N	Komatsu	Schlepper	SonstigeModelle	0	Zexel	DKS15CH	139	1	24			
851782N	Komatsu	Schlepper	SonstigeModelle	0	Zexel	DKS15CH	139	1	24		11	15
851775N	Komatsu	Schlepper	SonstigeModelle	0	Zexel	DKV14C	115	1	24			
851406N	Krone	Mährescher BIG M	BIGM	0	Sanden	SD7H15	132	2	12			
852994N	Kubota	Tractor M Serie	M96	0	Denso	SVO7E	118	1	12		15	17
852994N	Kubota	Tractor M Serie	M100	0	Denso	SVO7E	118	1	12		15	17
852994N	Kubota	Tractor M Serie	M110	0	Denso	SVO7E	118	1	12		15	17
852994N	Kubota	Tractor M Serie	M5040	0	Denso	SVO7E	118	1	12		15	17
852994N	Kubota	Tractor M Serie	M5140	0	Denso	SVO7E	118	1	12		15	17
852994N	Kubota	Tractor M Serie	M6040	0	Denso	SVO7E	118	1	12		15	17
852994N	Kubota	Tractor M Serie	M7040	0	Denso	SVO7E	118	1	12		15	17

Dasis Nr.	Hersteller	Modell	Typ	KW	Herstellereinschränkung	Kompressor-ID	Riemenscheiben-Ø [mm]	Rippenanzahl	Spannung [V]	Zylinderkopf-ID (Kompressor)	Einlass-Ø [mm]	Auslass-Ø [mm]
852994N	Kubota	Tractor M Serie	M8540	0	Denso	SVO7E	118	1	12		15	17
850327N	Lamborghini	Schlepper / Agile RS/RV	70	0	Sanden	SD7B10	115	2	12		14,9	12,2
850327N	Lamborghini	Schlepper / Agile RS/RV	75	0	Sanden	SD7B10	115	2	12		14,9	12,2
850327N	Lamborghini	Schlepper / Agile RS/RV	90	0	Sanden	SD7B10	115	2	12		14,9	12,2
850327N	Lamborghini	Schlepper / Agile RS/RV	100	0	Sanden	SD7B10	115	2	12		14,9	12,2
850327N	Lamborghini	Schlepper / Agile RS/RV	660F	0	Sanden	SD7B10	115	2	12		14,9	12,2
850327N	Lamborghini	Schlepper / Agile RS/RV	770F	0	Sanden	SD7B10	115	2	12		14,9	12,2
850327N	Lamborghini	Schlepper / Agile RS/RV	880F	0	Sanden	SD7B10	115	2	12		14,9	12,2
850327N	Lamborghini	Schlepper / Agile RS/RV	980F	0	Sanden	SD7B10	115	2	12		14,9	12,2
850892N	Lamborghini	Schlepper / Champion	180	0	Sanden	7H15	132	2	12	MJ	15	15
851699N	Lamborghini	Schlepper / Premium	105	0	Sanden	SD7H15HD	132	2	12	CB	14	14
851699N	Lamborghini	Schlepper / Premium	1600	0	Sanden	SD7H15HD	132	2	12	CB	14	14
851699N	Lamborghini	Schlepper / Premium	R4	0	Sanden	SD7H15HD	132	2	12	CB	14	14
851699N	Lamborghini	Schlepper / Sprint	684	0	Sanden	SD7H15HD	132	2	12	CB	14	14
851699N	Lamborghini	Schlepper / Sprint	685	0	Sanden	SD7H15HD	132	2	12	CB	14	14
851714N	Landini	Mähdrescher / Rex	75V	0	Delphi	SP-10	121	2	12		18	15
851714N	Landini	Mähdrescher / Rex	85V	0	Delphi	SP-10	121	2	12		18	15
851714N	Landini	Mähdrescher / Rex	90GT	0	Delphi	SP-10	121	2	12		18	15
851714N	Landini	Mähdrescher / Rex	95F	0	Delphi	SP-10	121	2	12		18	15
851714N	Landini	Schlepper / Globus	50	0	Delphi	SP-10	121	2	12		18	15
851714N	Landini	Schlepper / Globus	55	0	Delphi	SP-10	121	2	12		18	15
851714N	Landini	Schlepper / Globus	60	0	Delphi	SP-10	121	2	12		18	15

Dasis Nr.	Hersteller	Modell	Typ	KW	Herstellereinschränkung	Kompressor-ID	Riemenscheiben-Ø [mm]	Rippenanzahl	Spannung [V]	Zylinderkopf-ID (Kompressor)	Einlass-Ø [mm]	Auslass-Ø [mm]
851714N	Landini	Schlepper / Globus	65	0	Delphi	SP-10	121	2	12		18	15
851714N	Landini	Schlepper / Globus	70	0	Delphi	SP-10	121	2	12		18	15
851714N	Landini	Schlepper / Globus	75	0	Delphi	SP-10	121	2	12		18	15
851714N	Landini	Schlepper / Globus	80	0	Delphi	SP-10	121	2	12		18	15
850457N	Landini	Schlepper / Large	10000	0	Sanden	SD510	152	2	12	Q	16,3	16,3
850457N	Landini	Schlepper / Large	10000S	0	Sanden	SD510	152	2	12	Q	16,3	16,3
850457N	Landini	Schlepper / Large	12500	0	Sanden	SD510	152	2	12	Q	16,3	16,3
850457N	Landini	Schlepper / Large	13000	0	Sanden	SD510	152	2	12	Q	16,3	16,3
850457N	Landini	Schlepper / Large	14500	0	Sanden	SD510	152	2	12	Q	16,3	16,3
851408N	Landini	Schlepper / Legend	105	0	Sanden	SD7H15HD	132	2	12		17	17
851408N	Landini	Schlepper / Legend	115	0	Sanden	SD7H15HD	132	2	12		17	17
851408N	Landini	Schlepper / Legend	130	0	Sanden	SD7H15HD	132	2	12		17	17
851408N	Landini	Schlepper / Legend	145	0	Sanden	SD7H15HD	132	2	12		17	17
851408N	Landini	Schlepper / Legend	165	0	Sanden	SD7H15HD	132	2	12		17	17
851714N	Landini	Schlepper / Mythos	90	0	Delphi	SP-10	121	2	12		18	15
851714N	Landini	Schlepper / Mythos	100	0	Delphi	SP-10	121	2	12		18	15
851714N	Landini	Schlepper / Mythos	110	0	Delphi	SP-10	121	2	12		18	15
851408N	Landini	Schlepper / Mythos	115	0	Sanden	SD7H15HD	132	2	12		17	17
851787N	Landini	Schlepper / Power Farm	95	0								
851787N	Landini	Schlepper / Power Farm	105	0								
851714N	Landini	Schlepper / Vision New Räder 2	85	0	Delphi	SP-10	121	2	12		18	15
851714N	Landini	Schlepper / Vision New Räder 2	95	0	Delphi	SP-10	121	2	12		18	15

Dasis Nr.	Hersteller	Modell	Typ	KW	Herstellereinschränkung	Kompressor-ID	Riemenscheiben-Ø [mm]	Rippenanzahl	Spannung [V]	Zylinderkopf-ID (Kompressor)	Einlass-Ø [mm]	Auslass-Ø [mm]
851714N	Landini	Schlepper / Vision New Räder 2	105	0	Delphi	SP-10	121	2	12		18	15
851742N	Landini	Schlepper Wein Obst	Sonstige	0	Delphi	V5	132	2	12			
851408N	Landini	Schlepper Wein Obst / Advantage	55F	0	Sanden	SD7H15HD	132	2	12		17	17
851408N	Landini	Schlepper Wein Obst / Advantage	60F	0	Sanden	SD7H15HD	132	2	12		17	17
851408N	Landini	Schlepper Wein Obst / Advantage	65F	0	Sanden	SD7H15HD	132	2	12		17	17
851408N	Landini	Schlepper Wein Obst / Advantage	75F	0	Sanden	SD7H15HD	132	2	12		17	17
851408N	Landini	Schlepper Wein Obst / Advantage	85F	0	Sanden	SD7H15HD	132	2	12		17	17
850414N	Laverda	Bagger 360°	Sonstige	0	Sanden	SD5H14	132	2	12	M	13	11
850421N	Laverda	Mähdrescher / 3000	3000	0	York	F209/210R			12		14	11,9
850421N	Laverda	Mähdrescher / 3000	3700	0	York	F209/210R			12		14	11,9
851109N	Laverda	Mähdrescher / 3000	3850	0	Sanden	SD508	132	2	12	N	20,4	17,5
851699N	Laverda	Mähdrescher / REV	225	0	Sanden	SD7H15HD	132	2	12	CB	14	14
852921N	Liebherr	Liebherr Bagger 360° / 300	A314	0	Sanden	SD7H15	119	8	24	KG		
851709N	Liebherr	Liebherr Bagger 360° / 500	554	0		SD7H14	119	8	12			
851709N	Liebherr	Liebherr Bagger 360° / 500	564	0		SD7H14	119	8	12			
851709N	Liebherr	Liebherr Bagger 360° / 900	914	0		SD7H14	119	8	12			
851704N	Liebherr	Liebherr Bagger 360° / 900	954	0	Sanden	SD5H14	132	2	12		16	13
851764N	Liebherr	Schlepper	SonstigeModelle	0	Sanden	SD7H15	119	8	24			
851699N	Manitou	Schlepper / MLT 7B-E2	731T B-E2	0	Sanden	SD7H15HD	132	2	12	CB	14	14
851699N	Manitou	Schlepper / MLT 7B-E2	731T B-E2 LS	0	Sanden	SD7H15HD	132	2	12	CB	14	14
851699N	Manitou	Teleskoplader / MLT/MLA	523S1	0	Sanden	SD7H15HD	132	2	12	CB	14	14
851699N	Manitou	Teleskoplader / MLT/MLA	523S2-	0	Sanden	SD7H15HD	132	2	12	CB	14	14



Dasis Nr.	Hersteller	Modell	Typ	KW	Herstellereinschränkung	Kompressor-ID	Riemenscheiben-Ø [mm]	Rippenanzahl	Spannung [V]	Zylinderkopf-ID (Kompressor)	Einlass-Ø [mm]	Auslass-Ø [mm]
851699N	Manitou	Teleskopklader / MLT/MLA	523TS1	0	Sanden	SD7H15HD	132	2	12	CB	14	14
851699N	Manitou	Teleskopklader / MLT/MLA	523TS2	0	Sanden	SD7H15HD	132	2	12	CB	14	14
851699N	Manitou	Teleskopklader / MLT/MLA	524S1	0	Sanden	SD7H15HD	132	2	12	CB	14	14
851699N	Manitou	Teleskopklader / MLT/MLA	524TS1	0	Sanden	SD7H15HD	132	2	12	CB	14	14
851699N	Manitou	Teleskopklader / MLT/MLA	526A	0	Sanden	SD7H15HD	132	2	12	CB	14	14
851699N	Manitou	Teleskopklader / MLT/MLA	526S1	0	Sanden	SD7H15HD	132	2	12	CB	14	14
851699N	Manitou	Teleskopklader / MLT/MLA	526S2	0	Sanden	SD7H15HD	132	2	12	CB	14	14
851699N	Manitou	Teleskopklader / MLT/MLA	526TA	0	Sanden	SD7H15HD	132	2	12	CB	14	14
851699N	Manitou	Teleskopklader / MLT/MLA	526TACompact	0	Sanden	SD7H15HD	132	2	12	CB	14	14
851699N	Manitou	Teleskopklader / MLT/MLA	526TS1	0	Sanden	SD7H15HD	132	2	12	CB	14	14
851699N	Manitou	Teleskopklader / MLT/MLA	526TS2	0	Sanden	SD7H15HD	132	2	12	CB	14	14
851699N	Manitou	Teleskopklader / MLT/MLA	527S1	0	Sanden	SD7H15HD	132	2	12	CB	14	14
851699N	Manitou	Teleskopklader / MLT/MLA	527TS1	0	Sanden	SD7H15HD	132	2	12	CB	14	14
851699N	Manitou	Teleskopklader / MLT/MLA	626S2	0	Sanden	SD7H15HD	132	2	12	CB	14	14
851699N	Manitou	Teleskopklader / MLT/MLA	626S3	0	Sanden	SD7H15HD	132	2	12	CB	14	14
851699N	Manitou	Teleskopklader / MLT/MLA	626TS2	0	Sanden	SD7H15HD	132	2	12	CB	14	14
851699N	Manitou	Teleskopklader / MLT/MLA	626TS3	0	Sanden	SD7H15HD	132	2	12	CB	14	14
851699N	Manitou	Teleskopklader / MLT/MLA	627S1	0	Sanden	SD7H15HD	132	2	12	CB	14	14
851699N	Manitou	Teleskopklader / MLT/MLA	628-120S3-E2PSLS	0	Sanden	SD7H15HD	132	2	12	CB	14	14
851699N	Manitou	Teleskopklader / MLT/MLA	628S1	0	Sanden	SD7H15HD	132	2	12	CB	14	14
851699N	Manitou	Teleskopklader / MLT/MLA	628TS1	0	Sanden	SD7H15HD	132	2	12	CB	14	14

Dasis Nr.	Hersteller	Modell	Typ	KW	Herstellereinschränkung	Kompressor-ID	Riemenscheiben-Ø [mm]	Rippenanzahl	Spannung [V]	Zylinderkopf-ID (Kompressor)	Einlass-Ø [mm]	Auslass-Ø [mm]
851699N	Manitou	Teleskopklader / MLT/MLA	628TS2PS	0	Sanden	SD7H15HD	132	2	12	CB	14	14
851699N	Manitou	Teleskopklader / MLT/MLA	628TS2PSLS	0	Sanden	SD7H15HD	132	2	12	CB	14	14
851699N	Manitou	Teleskopklader / MLT/MLA	628TS3-E2PS	0	Sanden	SD7H15HD	132	2	12	CB	14	14
851699N	Manitou	Teleskopklader / MLT/MLA	629-120ALS	0	Sanden	SD7H15HD	132	2	12	CB	14	14
851699N	Manitou	Teleskopklader / MLT/MLA	629A	0	Sanden	SD7H15HD	132	2	12	CB	14	14
851699N	Manitou	Teleskopklader / MLT/MLA	629S1	0	Sanden	SD7H15HD	132	2	12	CB	14	14
851699N	Manitou	Teleskopklader / MLT/MLA	629TA	0	Sanden	SD7H15HD	132	2	12	CB	14	14
851699N	Manitou	Teleskopklader / MLT/MLA	629TS1	0	Sanden	SD7H15HD	132	2	12	CB	14	14
851699N	Manitou	Teleskopklader / MLT/MLA	630-120B-E2LS	0	Sanden	SD7H15HD	132	2	12	CB	14	14
851699N	Manitou	Teleskopklader / MLT/MLA	630S3	0	Sanden	SD7H15HD	132	2	12	CB	14	14
851699N	Manitou	Teleskopklader / MLT/MLA	630TB-E2	0	Sanden	SD7H15HD	132	2	12	CB	14	14
851699N	Manitou	Teleskopklader / MLT/MLA	630TS3	0	Sanden	SD7H15HD	132	2	12	CB	14	14
851699N	Manitou	Teleskopklader / MLT/MLA	632S1	0	Sanden	SD7H15HD	132	2	12	CB	14	14
851699N	Manitou	Teleskopklader / MLT/MLA	632TS1	0	Sanden	SD7H15HD	132	2	12	CB	14	14
851699N	Manitou	Teleskopklader / MLT/MLA	633-120APSL	0	Sanden	SD7H15HD	132	2	12	CB	14	14
851699N	Manitou	Teleskopklader / MLT/MLA	633-120S1LS	0	Sanden	SD7H15HD	132	2	12	CB	14	14
851699N	Manitou	Teleskopklader / MLT/MLA	633-120S1PSLS	0	Sanden	SD7H15HD	132	2	12	CB	14	14
851699N	Manitou	Teleskopklader / MLT/MLA	633TALS	0	Sanden	SD7H15HD	132	2	12	CB	14	14
851699N	Manitou	Teleskopklader / MLT/MLA	633TS1LS	0	Sanden	SD7H15HD	132	2	12	CB	14	14
851699N	Manitou	Teleskopklader / MLT/MLA	633TS1PS	0	Sanden	SD7H15HD	132	2	12	CB	14	14
851699N	Manitou	Teleskopklader / MLT/MLA	634-120B-E2LS	0	Sanden	SD7H15HD	132	2	12	CB	14	14

Dasis Nr.	Hersteller	Modell	Typ	KW	Herstellereinschränkung	Kompressor-ID	Riemenscheiben-Ø [mm]	Rippenanzahl	Spannung [V]	Zylinderkopf-ID (Kompressor)	Einlass-Ø [mm]	Auslass-Ø [mm]
851699N	Manitou	Teleskopklader / MLT/MLA	634-120B-E2PSLS	0	Sanden	SD7H15HD	132	2	12	CB	14	14
851699N	Manitou	Teleskopklader / MLT/MLA	634TB-E2LS	0	Sanden	SD7H15HD	132	2	12	CB	14	14
851699N	Manitou	Teleskopklader / MLT/MLA	725S2	0	Sanden	SD7H15HD	132	2	12	CB	14	14
851699N	Manitou	Teleskopklader / MLT/MLA	725S3	0	Sanden	SD7H15HD	132	2	12	CB	14	14
851699N	Manitou	Teleskopklader / MLT/MLA	725TS2	0	Sanden	SD7H15HD	132	2	12	CB	14	14
851699N	Manitou	Teleskopklader / MLT/MLA	725TS3	0	Sanden	SD7H15HD	132	2	12	CB	14	14
851699N	Manitou	Teleskopklader / MLT/MLA	728S1	0	Sanden	SD7H15HD	132	2	12	CB	14	14
851699N	Manitou	Teleskopklader / MLT/MLA	728TS1	0	Sanden	SD7H15HD	132	2	12	CB	14	14
851699N	Manitou	Teleskopklader / MLT/MLA	730-120ALS	0	Sanden	SD7H15HD	132	2	12	CB	14	14
851699N	Manitou	Teleskopklader / MLT/MLA	730-120APSL	0	Sanden	SD7H15HD	132	2	12	CB	14	14
851699N	Manitou	Teleskopklader / MLT/MLA	730-120S1LS	0	Sanden	SD7H15HD	132	2	12	CB	14	14
851699N	Manitou	Teleskopklader / MLT/MLA	730-120S1PSLS	0	Sanden	SD7H15HD	132	2	12	CB	14	14
851699N	Manitou	Teleskopklader / MLT/MLA	730A	0	Sanden	SD7H15HD	132	2	12	CB	14	14
851699N	Manitou	Teleskopklader / MLT/MLA	730S1	0	Sanden	SD7H15HD	132	2	12	CB	14	14
851699N	Manitou	Teleskopklader / MLT/MLA	730TA	0	Sanden	SD7H15HD	132	2	12	CB	14	14
851699N	Manitou	Teleskopklader / MLT/MLA	730TALS	0	Sanden	SD7H15HD	132	2	12	CB	14	14
851699N	Manitou	Teleskopklader / MLT/MLA	730TS1	0	Sanden	SD7H15HD	132	2	12	CB	14	14
851699N	Manitou	Teleskopklader / MLT/MLA	730TS1LS	0	Sanden	SD7H15HD	132	2	12	CB	14	14
851699N	Manitou	Teleskopklader / MLT/MLA	731TB-E2	0	Sanden	SD7H15HD	132	2	12	CB	14	14
851699N	Manitou	Teleskopklader / MLT/MLA	731TB-E2LS	0	Sanden	SD7H15HD	132	2	12	CB	14	14
851699N	Manitou	Teleskopklader / MLT/MLA	740TS1HLS	0	Sanden	SD7H15HD	132	2	12	CB	14	14

Dasis Nr.	Hersteller	Modell	Typ	KW	Herstellereinschränkung	Kompressor-ID	Riemenscheiben-Ø [mm]	Rippenanzahl	Spannung [V]	Zylinderkopf-ID (Kompressor)	Einlass-Ø [mm]	Auslass-Ø [mm]
851699N	Manitou	Teleskoplader / MLT/MLA	741-120S2-E2LS	0	Sanden	SD7H15HD	132	2	12	CB	14	14
851699N	Manitou	Teleskoplader / MLT/MLA	741-120S2-E2PSLS	0	Sanden	SD7H15HD	132	2	12	CB	14	14
851699N	Manitou	Teleskoplader / MLT/MLA	742TS2-E2	0	Sanden	SD7H15HD	132	2	12	CB	14	14
851699N	Manitou	Teleskoplader / MLT/MLA	742TS2-E2HLS	0	Sanden	SD7H15HD	132	2	12	CB	14	14
850409N	Massey Ferguson	Mähdrescher / 10-900	740	0	GM Harrison	A6	139	1	12			
851753N	Massey Ferguson	Mähdrescher / 10-900	740	0	GM Harrison	A6	139	1	12		16	16
850409N	Massey Ferguson	Mähdrescher / 10-900	750	0	GM Harrison	A6	139	1	12			
851753N	Massey Ferguson	Mähdrescher / 10-900	750	0	GM Harrison	A6	139	1	12		16	16
850409N	Massey Ferguson	Mähdrescher / 10-900	760	0	GM Harrison	A6	139	1	12			
851753N	Massey Ferguson	Mähdrescher / 10-900	760	0	GM Harrison	A6	139	1	12		16	16
850409N	Massey Ferguson	Mähdrescher / 10-900	800	0	GM Harrison	A6	139	1	12			
851753N	Massey Ferguson	Mähdrescher / 10-900	800	0	GM Harrison	A6	139	1	12		16	16
850409N	Massey Ferguson	Mähdrescher / 10-900	805	0	GM Harrison	A6	139	1	12			
851753N	Massey Ferguson	Mähdrescher / 10-900	805	0	GM Harrison	A6	139	1	12		16	16
850409N	Massey Ferguson	Mähdrescher / 10-900	810	0	GM Harrison	A6	139	1	12			
851753N	Massey Ferguson	Mähdrescher / 10-900	810	0	GM Harrison	A6	139	1	12		16	16
850409N	Massey Ferguson	Mähdrescher / 10-900	815	0	GM Harrison	A6	139	1	12			
851753N	Massey Ferguson	Mähdrescher / 10-900	815	0	GM Harrison	A6	139	1	12		16	16
850409N	Massey Ferguson	Mähdrescher / 10-900	820	0	GM Harrison	A6	139	1	12			
851753N	Massey Ferguson	Mähdrescher / 10-900	820	0	GM Harrison	A6	139	1	12		16	16
851753N	Massey Ferguson	Mähdrescher / 10-900	830	0	GM Harrison	A6	139	1	12		16	16

Dasis Nr.	Hersteller	Modell	Typ	KW	Herstellereinschränkung	Kompressor-ID	Riemenscheiben-Ø [mm]	Rippenanzahl	Spannung [V]	Zylinderkopf-ID (Kompressor)	Einlass-Ø [mm]	Auslass-Ø [mm]
851753N	Massey Ferguson	Mähdrescher / 10-900	835	0	GM Harrison	A6	139	1	12		16	16
851753N	Massey Ferguson	Mähdrescher / 10-900	840	0	GM Harrison	A6	139	1	12		16	16
851753N	Massey Ferguson	Mähdrescher / 10-900	845	0	GM Harrison	A6	139	1	12		16	16
851753N	Massey Ferguson	Mähdrescher / 10-900	850	0	GM Harrison	A6	139	1	12		16	16
850409N	Massey Ferguson	Mähdrescher / 10-900	860	0	GM Harrison	A6	139	1	12			
851753N	Massey Ferguson	Mähdrescher / 10-900	860	0	GM Harrison	A6	139	1	12		16	16
850409N	Massey Ferguson	Mähdrescher / 10-900	865	0	GM Harrison	A6	139	1	12			
851753N	Massey Ferguson	Mähdrescher / 10-900	865	0	GM Harrison	A6	139	1	12		16	16
850327N	Massey Ferguson	Mähdrescher / 3400-9790	3425V	0	Sanden	SD7B10	115	2	12		14,9	12,2
850327N	Massey Ferguson	Mähdrescher / 3400-9790	3435V	0	Sanden	SD7B10	115	2	12		14,9	12,2
850327N	Massey Ferguson	Mähdrescher / 3400-9790	3445V	0	Sanden	SD7B10	115	2	12		14,9	12,2
850327N	Massey Ferguson	Mähdrescher / 3400-9790	3455V	0	Sanden	SD7B10	115	2	12		14,9	12,2
851699N	Massey Ferguson	Mähdrescher / 3400-9790	7244	0	Sanden	SD7H15HD	132	2	12	CB	14	14
850885N	Massey Ferguson	Mähdrescher / 3400-9790	7250	0	Sanden	SD508	132	2	12	FL	16	14
850885N	Massey Ferguson	Mähdrescher / 3400-9790	7252	0	Sanden	SD508	132	2	12	FL	16	14
850885N	Massey Ferguson	Mähdrescher / 3400-9790	7254	0	Sanden	SD508	132	2	12	FL	16	14
850885N	Massey Ferguson	Mähdrescher / 3400-9790	7256	0	Sanden	SD508	132	2	12	FL	16	14
850885N	Massey Ferguson	Mähdrescher / 3400-9790	7272	0	Sanden	SD508	132	2	12	FL	16	14
850885N	Massey Ferguson	Mähdrescher / 3400-9790	7274	0	Sanden	SD508	132	2	12	FL	16	14
850885N	Massey Ferguson	Mähdrescher / 3400-9790	7276	0	Sanden	SD508	132	2	12	FL	16	14
850885N	Massey Ferguson	Mähdrescher / 3400-9790	7278	0	Sanden	SD508	132	2	12	FL	16	14

Dasis Nr.	Hersteller	Modell	Typ	KW	Herstellereinschränkung	Kompressor-ID	Riemenscheiben-Ø [mm]	Rippenanzahl	Spannung [V]	Zylinderkopf-ID (Kompressor)	Einlass-Ø [mm]	Auslass-Ø [mm]
850422N	Massey Ferguson	Mähdrescher / 3400-9790	8450	0	York	R209/210R	ohne Riemenscheibe	ohne Riemenscheibe			13,5	13,5
850422N	Massey Ferguson	Mähdrescher / 3400-9790	8460	0	York	R209/210R	ohne Riemenscheibe	ohne Riemenscheibe			13,5	13,5
850426N	Massey Ferguson	Mähdrescher / 3400-9790	8570	0	Harrison	R4	136	1	12			
850426N	Massey Ferguson	Mähdrescher / 3400-9790	8590	0	Harrison	R4	136	1	12			
851699N	Massey Ferguson	Mähdrescher / 3400-9790	8680	0	Sanden	SD7H15HD	132	2	12	CB	14	14
850352N	Massey Ferguson	Mähdrescher / 3400-9790	8680	0	York	T209/210L					14,9	14,9
850426N	Massey Ferguson	Mähdrescher / 3400-9790	8780	0	Harrison	R4	136	1	12			
851699N	Massey Ferguson	Mähdrescher / 3400-9790	8780	0	Sanden	SD7H15HD	132	2	12	CB	14	14
852923N	Massey Ferguson	Mähdrescher / 3400-9790	9520	0	Sanden	SD7H15	133	6	12			
852923N	Massey Ferguson	Mähdrescher / 3400-9790	9530	0	Sanden	SD7H15	133	6	12			
852923N	Massey Ferguson	Mähdrescher / 3400-9790	9540	0	Sanden	SD7H15	133	6	12			
852923N	Massey Ferguson	Mähdrescher / 3400-9790	9550	0	Sanden	SD7H15	133	6	12			
852923N	Massey Ferguson	Mähdrescher / 3400-9790	9560	0	Sanden	SD7H15	133	6	12			
850422N	Massey Ferguson	Mähdrescher / 3400-9790	9720	0	York	R209/210R	ohne Riemenscheibe	ohne Riemenscheibe			13,5	13,5
850352N	Massey Ferguson	Mähdrescher / 3400-9790	9720	0	York	T209/210L					14,9	14,9
851699N	Massey Ferguson	Mähdrescher / 3400-9790	9790	0	Sanden	SD7H15HD	132	2	12	CB	14	14
858485N	Massey Ferguson	Mähdrescher / MF 24-40	24	0	Sanden	SD5H14	132	2	12	B		
850422N	Massey Ferguson	Mähdrescher / MF 24-40	27	0	York	R209/210R	ohne Riemenscheibe	ohne Riemenscheibe			13,5	13,5
850422N	Massey Ferguson	Mähdrescher / MF 24-40	29	0	York	R209/210R	ohne Riemenscheibe	ohne Riemenscheibe			13,5	13,5
858485N	Massey Ferguson	Mähdrescher / MF 24-40	29XP	0	Sanden	SD5H14	132	2	12	B		
858485N	Massey Ferguson	Mähdrescher / MF 24-40	30	0	Sanden	SD5H14	132	2	12	B		

Dasis Nr.	Hersteller	Modell	Typ	KW	Herstellereinschränkung	Kompressor-ID	Riemenscheiben-Ø [mm]	Rippenanzahl	Spannung [V]	Zylinderkopf-ID (Kompressor)	Einlass-Ø [mm]	Auslass-Ø [mm]
850422N	Massey Ferguson	Mähdrescher / MF 24-40	31	0	York	R209/210R	ohne Riemenscheibe	ohne Riemenscheibe			13,5	13,5
858485N	Massey Ferguson	Mähdrescher / MF 24-40	31XP	0	Sanden	SD5H14	132	2	12	B		
858485N	Massey Ferguson	Mähdrescher / MF 24-40	32	0	Sanden	SD5H14	132	2	12	B		
858485N	Massey Ferguson	Mähdrescher / MF 24-40	34	0	Sanden	SD5H14	132	2	12	B		
858485N	Massey Ferguson	Mähdrescher / MF 24-40	36	0	Sanden	SD5H14	132	2	12	B		
858485N	Massey Ferguson	Mähdrescher / MF 24-40	38	0	Sanden	SD5H14	132	2	12	B		
858485N	Massey Ferguson	Mähdrescher / MF 24-40	40	0	Sanden	SD5H14	132	2	12	B		
852923N	Massey Ferguson	Mähdrescher / WR	9740	0	Sanden	SD7H15	133	6	12			
852923N	Massey Ferguson	Mähdrescher / WR	9760	0	Sanden	SD7H15	133	6	12			
852923N	Massey Ferguson	Mähdrescher / WR	9770	0	Sanden	SD7H15	133	6	12			
852923N	Massey Ferguson	Mähdrescher / WR	9860	0	Sanden	SD7H15	133	6	12			
852923N	Massey Ferguson	Mähdrescher / WR	9870	0	Sanden	SD7H15	133	6	12			
850626N	Massey Ferguson	Schlepper / 300	340	0	Sanden	SD7H15	120	10	24	VE	17,8	11,8
850625N	Massey Ferguson	Schlepper / 300	340	0	Sanden	SD7H15	132	2	12	QC	16	16
850882N	Massey Ferguson	Schlepper / 300	340	0	Sanden	SD510	132	2	12		15	17
850625N	Massey Ferguson	Schlepper / 300	342	0	Sanden	SD7H15	132	2	12	QC	16	16
850882N	Massey Ferguson	Schlepper / 300	342	0	Sanden	SD510	132	2	12		15	17
850626N	Massey Ferguson	Schlepper / 300	350	0	Sanden	SD7H15	120	10	24	VE	17,8	11,8
850625N	Massey Ferguson	Schlepper / 300	350	0	Sanden	SD7H15	132	2	12	QC	16	16
850882N	Massey Ferguson	Schlepper / 300	350	0	Sanden	SD510	132	2	12		15	17
850626N	Massey Ferguson	Schlepper / 300	352	0	Sanden	SD7H15	120	10	24	VE	17,8	11,8

Dasis Nr.	Hersteller	Modell	Typ	KW	Herstellereinschränkung	Kompressor-ID	Riemenscheiben-Ø [mm]	Rippenanzahl	Spannung [V]	Zylinderkopf-ID (Kompressor)	Einlass-Ø [mm]	Auslass-Ø [mm]
850625N	Massey Ferguson	Schlepper / 300	352	0	Sanden	SD7H15	132	2	12	QC	16	16
850882N	Massey Ferguson	Schlepper / 300	352	0	Sanden	SD510	132	2	12		15	17
850626N	Massey Ferguson	Schlepper / 300	353	0	Sanden	SD7H15	120	10	24	VE	17,8	11,8
850625N	Massey Ferguson	Schlepper / 300	353	0	Sanden	SD7H15	132	2	12	QC	16	16
850882N	Massey Ferguson	Schlepper / 300	353	0	Sanden	SD510	132	2	12		15	17
850625N	Massey Ferguson	Schlepper / 300	354	0	Sanden	SD7H15	132	2	12	QC	16	16
850882N	Massey Ferguson	Schlepper / 300	354	0	Sanden	SD510	132	2	12		15	17
850626N	Massey Ferguson	Schlepper / 300	355	0	Sanden	SD7H15	120	10	24	VE	17,8	11,8
850625N	Massey Ferguson	Schlepper / 300	355	0	Sanden	SD7H15	132	2	12	QC	16	16
850882N	Massey Ferguson	Schlepper / 300	355	0	Sanden	SD510	132	2	12		15	17
850625N	Massey Ferguson	Schlepper / 300	360	0	Sanden	SD7H15	132	2	12	QC	16	16
850882N	Massey Ferguson	Schlepper / 300	360	0	Sanden	SD510	132	2	12		15	17
850625N	Massey Ferguson	Schlepper / 300	362	0	Sanden	SD7H15	132	2	12	QC	16	16
850882N	Massey Ferguson	Schlepper / 300	362	0	Sanden	SD510	132	2	12		15	17
850882N	Massey Ferguson	Schlepper / 300	362N	0	Sanden	SD510	132	2	12		15	17
850625N	Massey Ferguson	Schlepper / 300	363	0	Sanden	SD7H15	132	2	12	QC	16	16
850882N	Massey Ferguson	Schlepper / 300	363	0	Sanden	SD510	132	2	12		15	17
850626N	Massey Ferguson	Schlepper / 300	363S	0	Sanden	SD7H15	120	10	24	VE	17,8	11,8
850626N	Massey Ferguson	Schlepper / 300	365	0	Sanden	SD7H15	120	10	24	VE	17,8	11,8
850625N	Massey Ferguson	Schlepper / 300	365	0	Sanden	SD7H15	132	2	12	QC	16	16
850882N	Massey Ferguson	Schlepper / 300	365	0	Sanden	SD510	132	2	12		15	17



Dasis Nr.	Hersteller	Modell	Typ	KW	Herstellereinschränkung	Kompressor-ID	Riemenscheiben-Ø [mm]	Rippenanzahl	Spannung [V]	Zylinderkopf-ID (Kompressor)	Einlass-Ø [mm]	Auslass-Ø [mm]
850625N	Massey Ferguson	Schlepper / 300	372	0	Sanden	SD7H15	132	2	12	QC	16	16
850882N	Massey Ferguson	Schlepper / 300	372	0	Sanden	SD510	132	2	12		15	17
850626N	Massey Ferguson	Schlepper / 300	372N	0	Sanden	SD7H15	120	10	24	VE	17,8	11,8
850892N	Massey Ferguson	Schlepper / 300	373	0	Sanden	7H15	132	2	12	MJ	15	15
850626N	Massey Ferguson	Schlepper / 300	373	0	Sanden	SD7H15	120	10	24	VE	17,8	11,8
850892N	Massey Ferguson	Schlepper / 300	373S	0	Sanden	7H15	132	2	12	MJ	15	15
850892N	Massey Ferguson	Schlepper / 300	374	0	Sanden	7H15	132	2	12	MJ	15	15
850892N	Massey Ferguson	Schlepper / 300	374S	0	Sanden	7H15	132	2	12	MJ	15	15
850625N	Massey Ferguson	Schlepper / 300	375	0	Sanden	SD7H15	132	2	12	QC	16	16
850882N	Massey Ferguson	Schlepper / 300	375	0	Sanden	SD510	132	2	12		15	17
850625N	Massey Ferguson	Schlepper / 300	377	0	Sanden	SD7H15	132	2	12	QC	16	16
850882N	Massey Ferguson	Schlepper / 300	377	0	Sanden	SD510	132	2	12		15	17
850625N	Massey Ferguson	Schlepper / 300	382	0	Sanden	SD7H15	132	2	12	QC	16	16
850882N	Massey Ferguson	Schlepper / 300	382	0	Sanden	SD510	132	2	12		15	17
850892N	Massey Ferguson	Schlepper / 300	383	0	Sanden	7H15	132	2	12	MJ	15	15
850892N	Massey Ferguson	Schlepper / 300	383S	0	Sanden	7H15	132	2	12	MJ	15	15
850892N	Massey Ferguson	Schlepper / 300	384	0	Sanden	7H15	132	2	12	MJ	15	15
850892N	Massey Ferguson	Schlepper / 300	384F	0	Sanden	7H15	132	2	12	MJ	15	15
850625N	Massey Ferguson	Schlepper / 300	384S	0	Sanden	SD7H15	132	2	12	QC	16	16
850882N	Massey Ferguson	Schlepper / 300	384S	0	Sanden	SD510	132	2	12		15	17
850625N	Massey Ferguson	Schlepper / 300	387	0	Sanden	SD7H15	132	2	12	QC	16	16

Dasis Nr.	Hersteller	Modell	Typ	KW	Herstellereinschränkung	Kompressor-ID	Riemenscheiben-Ø [mm]	Rippenanzahl	Spannung [V]	Zylinderkopf-ID (Kompressor)	Einlass-Ø [mm]	Auslass-Ø [mm]
850882N	Massey Ferguson	Schlepper / 300	387	0	Sanden	SD510	132	2	12		15	17
850625N	Massey Ferguson	Schlepper / 300	390	0	Sanden	SD7H15	132	2	12	QC	16	16
850882N	Massey Ferguson	Schlepper / 300	390	0	Sanden	SD510	132	2	12		15	17
850882N	Massey Ferguson	Schlepper / 300	390T	0	Sanden	SD510	132	2	12		15	17
850892N	Massey Ferguson	Schlepper / 300	393	0	Sanden	7H15	132	2	12	MJ	15	15
850892N	Massey Ferguson	Schlepper / 300	393S	0	Sanden	7H15	132	2	12	MJ	15	15
850892N	Massey Ferguson	Schlepper / 300	394	0	Sanden	7H15	132	2	12	MJ	15	15
850892N	Massey Ferguson	Schlepper / 300	394F	0	Sanden	7H15	132	2	12	MJ	15	15
850892N	Massey Ferguson	Schlepper / 300	394S	0	Sanden	7H15	132	2	12	MJ	15	15
850625N	Massey Ferguson	Schlepper / 300	397	0	Sanden	SD7H15	132	2	12	QC	16	16
850882N	Massey Ferguson	Schlepper / 300	397	0	Sanden	SD510	132	2	12		15	17
850625N	Massey Ferguson	Schlepper / 300	398	0	Sanden	SD7H15	132	2	12	QC	16	16
850882N	Massey Ferguson	Schlepper / 300	398	0	Sanden	SD510	132	2	12		15	17
850626N	Massey Ferguson	Schlepper / 300	399	0	Sanden	SD7H15	120	10	24	VE	17,8	11,8
850625N	Massey Ferguson	Schlepper / 300	399	0	Sanden	SD7H15	132	2	12	QC	16	16
850882N	Massey Ferguson	Schlepper / 300	399	0	Sanden	SD510	132	2	12		15	17
850426N	Massey Ferguson	Schlepper / 500	550	0	Harrison	R4	136	1	12			
850426N	Massey Ferguson	Schlepper / 500	560	0	Harrison	R4	136	1	12			
850426N	Massey Ferguson	Schlepper / 500	565	0	Harrison	R4	136	1	12			
850426N	Massey Ferguson	Schlepper / 500	575	0	Harrison	R4	136	1	12			
850426N	Massey Ferguson	Schlepper / 500	590	0	Harrison	R4	136	1	12			

Dasis Nr.	Hersteller	Modell	Typ	KW	Herstellereinschränkung	Kompressor-ID	Riemenscheiben-Ø [mm]	Rippenanzahl	Spannung [V]	Zylinderkopf-ID (Kompressor)	Einlass-Ø [mm]	Auslass-Ø [mm]
850426N	Massey Ferguson	Schlepper / 500	592	0	Harrison	R4	136	1	12			
850426N	Massey Ferguson	Schlepper / 500	595	0	Harrison	R4	136	1	12			
850426N	Massey Ferguson	Schlepper / 500	595K	0	Harrison	R4	136	1	12			
850870N	Massey Ferguson	Schlepper / 600-800	670	0	Sanden	SD5H14	132	2	12	FG	16	13
850870N	Massey Ferguson	Schlepper / 600-800	675	0	Sanden	SD5H14	132	2	12	FG	16	13
850870N	Massey Ferguson	Schlepper / 600-800	690	0	Sanden	SD5H14	132	2	12	FG	16	13
850870N	Massey Ferguson	Schlepper / 600-800	698	0	Sanden	SD5H14	132	2	12	FG	16	13
850870N	Massey Ferguson	Schlepper / 600-800	698T	0	Sanden	SD5H14	132	2	12	FG	16	13
850870N	Massey Ferguson	Schlepper / 600-800	699	0	Sanden	SD5H14	132	2	12	FG	16	13
850457N	Massey Ferguson	Schlepper / 1000	1004	0	Sanden	SD510	152	2	12	Q	16,3	16,3
850457N	Massey Ferguson	Schlepper / 1000	1007	0	Sanden	SD510	152	2	12	Q	16,3	16,3
850457N	Massey Ferguson	Schlepper / 1000	1014	0	Sanden	SD510	152	2	12	Q	16,3	16,3
850457N	Massey Ferguson	Schlepper / 1000	1080	0	Sanden	SD510	152	2	12	Q	16,3	16,3
850457N	Massey Ferguson	Schlepper / 1000	1085	0	Sanden	SD510	152	2	12	Q	16,3	16,3
850457N	Massey Ferguson	Schlepper / 1000	1100	0	Sanden	SD510	152	2	12	Q	16,3	16,3
850457N	Massey Ferguson	Schlepper / 1000	1105	0	Sanden	SD510	152	2	12	Q	16,3	16,3
850457N	Massey Ferguson	Schlepper / 1000	1114	0	Sanden	SD510	152	2	12	Q	16,3	16,3
850457N	Massey Ferguson	Schlepper / 1000	1130	0	Sanden	SD510	152	2	12	Q	16,3	16,3
850457N	Massey Ferguson	Schlepper / 1000	1134	0	Sanden	SD510	152	2	12	Q	16,3	16,3
850457N	Massey Ferguson	Schlepper / 1000	1135	0	Sanden	SD510	152	2	12	Q	16,3	16,3
850457N	Massey Ferguson	Schlepper / 1000	1155	0	Sanden	SD510	152	2	12	Q	16,3	16,3

Dasis Nr.	Hersteller	Modell	Typ	KW	Herstellereinschränkung	Kompressor-ID	Riemenscheiben-Ø [mm]	Rippenanzahl	Spannung [V]	Zylinderkopf-ID (Kompressor)	Einlass-Ø [mm]	Auslass-Ø [mm]
850457N	Massey Ferguson	Schlepper / 1000	1200	0	Sanden	SD510	152	2	12	Q	16,3	16,3
850457N	Massey Ferguson	Schlepper / 1000	1250	0	Sanden	SD510	152	2	12	Q	16,3	16,3
851714N	Massey Ferguson	Schlepper / 2000	2210	0	Delphi	SP-10	121	2	12		18	15
851714N	Massey Ferguson	Schlepper / 2000	2220	0	Delphi	SP-10	121	2	12		18	15
851714N	Massey Ferguson	Schlepper / 2000	2225	0	Delphi	SP-10	121	2	12		18	15
851714N	Massey Ferguson	Schlepper / 2000	2230	0	Delphi	SP-10	121	2	12		18	15
851714N	Massey Ferguson	Schlepper / 2000	2235	0	Delphi	SP-10	121	2	12		18	15
850409N	Massey Ferguson	Schlepper / 2000	2620	0	GM Harrison	A6	139	1	12			
851753N	Massey Ferguson	Schlepper / 2000	2620	0	GM Harrison	A6	139	1	12		16	16
850457N	Massey Ferguson	Schlepper / 2000	2620	0	Sanden	SD510	152	2	12	Q	16,3	16,3
850409N	Massey Ferguson	Schlepper / 2000	2625	0	GM Harrison	A6	139	1	12			
851753N	Massey Ferguson	Schlepper / 2000	2625	0	GM Harrison	A6	139	1	12		16	16
850457N	Massey Ferguson	Schlepper / 2000	2625	0	Sanden	SD510	152	2	12	Q	16,3	16,3
850409N	Massey Ferguson	Schlepper / 2000	2640	0	GM Harrison	A6	139	1	12			
851753N	Massey Ferguson	Schlepper / 2000	2640	0	GM Harrison	A6	139	1	12		16	16
850457N	Massey Ferguson	Schlepper / 2000	2640	0	Sanden	SD510	152	2	12	Q	16,3	16,3
850409N	Massey Ferguson	Schlepper / 2000	2645	0	GM Harrison	A6	139	1	12			
851753N	Massey Ferguson	Schlepper / 2000	2645	0	GM Harrison	A6	139	1	12		16	16
850457N	Massey Ferguson	Schlepper / 2000	2645	0	Sanden	SD510	152	2	12	Q	16,3	16,3
850409N	Massey Ferguson	Schlepper / 2000	2675	0	GM Harrison	A6	139	1	12			
851753N	Massey Ferguson	Schlepper / 2000	2675	0	GM Harrison	A6	139	1	12		16	16

Dasis Nr.	Hersteller	Modell	Typ	KW	Herstellereinschränkung	Kompressor-ID	Riemenscheiben-Ø [mm]	Rippenanzahl	Spannung [V]	Zylinderkopf-ID (Kompressor)	Einlass-Ø [mm]	Auslass-Ø [mm]
850457N	Massey Ferguson	Schlepper / 2000	2675	0	Sanden	SD510	152	2	12	Q	16,3	16,3
850409N	Massey Ferguson	Schlepper / 2000	2680	0	GM Harrison	A6	139	1	12			
851753N	Massey Ferguson	Schlepper / 2000	2680	0	GM Harrison	A6	139	1	12		16	16
850457N	Massey Ferguson	Schlepper / 2000	2680	0	Sanden	SD510	152	2	12	Q	16,3	16,3
850409N	Massey Ferguson	Schlepper / 2000	2685	0	GM Harrison	A6	139	1	12			
851753N	Massey Ferguson	Schlepper / 2000	2685	0	GM Harrison	A6	139	1	12		16	16
850457N	Massey Ferguson	Schlepper / 2000	2685	0	Sanden	SD510	152	2	12	Q	16,3	16,3
850409N	Massey Ferguson	Schlepper / 2000	2705	0	GM Harrison	A6	139	1	12			
851753N	Massey Ferguson	Schlepper / 2000	2705	0	GM Harrison	A6	139	1	12		16	16
850457N	Massey Ferguson	Schlepper / 2000	2705	0	Sanden	SD510	152	2	12	Q	16,3	16,3
851753N	Massey Ferguson	Schlepper / 2000	2720	0	GM Harrison	A6	139	1	12		16	16
850457N	Massey Ferguson	Schlepper / 2000	2720	0	Sanden	SD510	152	2	12	Q	16,3	16,3
851753N	Massey Ferguson	Schlepper / 2000	2725	0	GM Harrison	A6	139	1	12		16	16
850457N	Massey Ferguson	Schlepper / 2000	2725	0	Sanden	SD510	152	2	12	Q	16,3	16,3
851753N	Massey Ferguson	Schlepper / 2000	2775	0	GM Harrison	A6	139	1	12		16	16
850457N	Massey Ferguson	Schlepper / 2000	2775	0	Sanden	SD510	152	2	12	Q	16,3	16,3
850409N	Massey Ferguson	Schlepper / 2000	2805	0	GM Harrison	A6	139	1	12			
851753N	Massey Ferguson	Schlepper / 2000	2805	0	GM Harrison	A6	139	1	12		16	16
850883N	Massey Ferguson	Schlepper / 3000	3050	0	Sanden	SD510	140	2	12	QC	16,4	16,4
850457N	Massey Ferguson	Schlepper / 3000	3050	0	Sanden	SD510	152	2	12	Q	16,3	16,3
850883N	Massey Ferguson	Schlepper / 3000	3060	0	Sanden	SD510	140	2	12	QC	16,4	16,4

Dasis Nr.	Hersteller	Modell	Typ	KW	Herstellereinschränkung	Kompressor-ID	Riemenscheiben-Ø [mm]	Rippenanzahl	Spannung [V]	Zylinderkopf-ID (Kompressor)	Einlass-Ø [mm]	Auslass-Ø [mm]
850457N	Massey Ferguson	Schlepper / 3000	3060	0	Sanden	SD510	152	2	12	Q	16,3	16,3
850883N	Massey Ferguson	Schlepper / 3000	3065	0	Sanden	SD510	140	2	12	QC	16,4	16,4
850457N	Massey Ferguson	Schlepper / 3000	3065	0	Sanden	SD510	152	2	12	Q	16,3	16,3
850457N	Massey Ferguson	Schlepper / 3000	3070	0	Sanden	SD510	152	2	12	Q	16,3	16,3
850883N	Massey Ferguson	Schlepper / 3000	3075	0	Sanden	SD510	140	2	12	QC	16,4	16,4
850457N	Massey Ferguson	Schlepper / 3000	3075	0	Sanden	SD510	152	2	12	Q	16,3	16,3
850457N	Massey Ferguson	Schlepper / 3000	3080	0	Sanden	SD510	152	2	12	Q	16,3	16,3
850883N	Massey Ferguson	Schlepper / 3000	3085	0	Sanden	SD510	140	2	12	QC	16,4	16,4
850457N	Massey Ferguson	Schlepper / 3000	3085	0	Sanden	SD510	152	2	12	Q	16,3	16,3
850457N	Massey Ferguson	Schlepper / 3000	3090	0	Sanden	SD510	152	2	12	Q	16,3	16,3
850883N	Massey Ferguson	Schlepper / 3000	3095	0	Sanden	SD510	140	2	12	QC	16,4	16,4
850457N	Massey Ferguson	Schlepper / 3000	3095	0	Sanden	SD510	152	2	12	Q	16,3	16,3
850457N	Massey Ferguson	Schlepper / 3000	3115	0	Sanden	SD510	152	2	12	Q	16,3	16,3
850883N	Massey Ferguson	Schlepper / 3000	3120	0	Sanden	SD510	140	2	12	QC	16,4	16,4
850457N	Massey Ferguson	Schlepper / 3000	3120	0	Sanden	SD510	152	2	12	Q	16,3	16,3
850457N	Massey Ferguson	Schlepper / 3000	3120T	0	Sanden	SD510	152	2	12	Q	16,3	16,3
850883N	Massey Ferguson	Schlepper / 3000	3125	0	Sanden	SD510	140	2	12	QC	16,4	16,4
850457N	Massey Ferguson	Schlepper / 3000	3125	0	Sanden	SD510	152	2	12	Q	16,3	16,3
850457N	Massey Ferguson	Schlepper / 3000	3140	0	Sanden	SD510	152	2	12	Q	16,3	16,3
851714N	Massey Ferguson	Schlepper / 3000	3225	0	Delphi	SP-10	121	2	12		18	15
850327N	Massey Ferguson	Schlepper / 3000	3425S	0	Sanden	SD7B10	115	2	12		14,9	12,2

Dasis Nr.	Hersteller	Modell	Typ	KW	Herstellereinschränkung	Kompressor-ID	Riemenscheiben-Ø [mm]	Rippenanzahl	Spannung [V]	Zylinderkopf-ID (Kompressor)	Einlass-Ø [mm]	Auslass-Ø [mm]
850327N	Massey Ferguson	Schlepper / 3000	3435S	0	Sanden	SD7B10	115	2	12		14,9	12,2
850327N	Massey Ferguson	Schlepper / 3000	3445S	0	Sanden	SD7B10	115	2	12		14,9	12,2
850327N	Massey Ferguson	Schlepper / 3000	3455S	0	Sanden	SD7B10	115	2	12		14,9	12,2
850457N	Massey Ferguson	Schlepper / 3000	3505	0	Sanden	SD510	152	2	12	Q	16,3	16,3
850457N	Massey Ferguson	Schlepper / 3000	3525	0	Sanden	SD510	152	2	12	Q	16,3	16,3
850457N	Massey Ferguson	Schlepper / 3000	3545	0	Sanden	SD510	152	2	12	Q	16,3	16,3
850457N	Massey Ferguson	Schlepper / 3000	3610	0	Sanden	SD510	152	2	12	Q	16,3	16,3
850457N	Massey Ferguson	Schlepper / 3000	3630	0	Sanden	SD510	152	2	12	Q	16,3	16,3
850883N	Massey Ferguson	Schlepper / 3000	3635	0	Sanden	SD510	140	2	12	QC	16,4	16,4
850457N	Massey Ferguson	Schlepper / 3000	3635	0	Sanden	SD510	152	2	12	Q	16,3	16,3
850883N	Massey Ferguson	Schlepper / 3000	3645	0	Sanden	SD510	140	2	12	QC	16,4	16,4
850457N	Massey Ferguson	Schlepper / 3000	3645	0	Sanden	SD510	152	2	12	Q	16,3	16,3
850457N	Massey Ferguson	Schlepper / 3000	3650	0	Sanden	SD510	152	2	12	Q	16,3	16,3
850883N	Massey Ferguson	Schlepper / 3000	3655	0	Sanden	SD510	140	2	12	QC	16,4	16,4
850457N	Massey Ferguson	Schlepper / 3000	3655	0	Sanden	SD510	152	2	12	Q	16,3	16,3
850457N	Massey Ferguson	Schlepper / 3000	3660	0	Sanden	SD510	152	2	12	Q	16,3	16,3
850457N	Massey Ferguson	Schlepper / 3000	3670	0	Sanden	SD510	152	2	12	Q	16,3	16,3
850457N	Massey Ferguson	Schlepper / 3000	3680	0	Sanden	SD510	152	2	12	Q	16,3	16,3
850883N	Massey Ferguson	Schlepper / 3000	3690	0	Sanden	SD510	140	2	12	QC	16,4	16,4
850457N	Massey Ferguson	Schlepper / 3000	3690	0	Sanden	SD510	152	2	12	Q	16,3	16,3
850883N	Massey Ferguson	Schlepper / 4000	4225	0	Sanden	SD510	140	2	12	QC	16,4	16,4

Dasis Nr.	Hersteller	Modell	Typ	KW	Herstellereinschränkung	Kompressor-ID	Riemenscheiben-Ø [mm]	Rippenanzahl	Spannung [V]	Zylinderkopf-ID (Kompressor)	Einlass-Ø [mm]	Auslass-Ø [mm]
850883N	Massey Ferguson	Schlepper / 4000	4235	0	Sanden	SD510	140	2	12	QC	16,4	16,4
850883N	Massey Ferguson	Schlepper / 4000	4240	0	Sanden	SD510	140	2	12	QC	16,4	16,4
850883N	Massey Ferguson	Schlepper / 4000	4245	0	Sanden	SD510	140	2	12	QC	16,4	16,4
850883N	Massey Ferguson	Schlepper / 4000	4255	0	Sanden	SD510	140	2	12	QC	16,4	16,4
850883N	Massey Ferguson	Schlepper / 4000	4260	0	Sanden	SD510	140	2	12	QC	16,4	16,4
850883N	Massey Ferguson	Schlepper / 4000	4270	0	Sanden	SD510	140	2	12	QC	16,4	16,4
850883N	Massey Ferguson	Schlepper / 4000	4325	0	Sanden	SD510	140	2	12	QC	16,4	16,4
850883N	Massey Ferguson	Schlepper / 4000	4335	0	Sanden	SD510	140	2	12	QC	16,4	16,4
850883N	Massey Ferguson	Schlepper / 4000	4345	0	Sanden	SD510	140	2	12	QC	16,4	16,4
850883N	Massey Ferguson	Schlepper / 4000	4355	0	Sanden	SD510	140	2	12	QC	16,4	16,4
850883N	Massey Ferguson	Schlepper / 4000	4360	0	Sanden	SD510	140	2	12	QC	16,4	16,4
850883N	Massey Ferguson	Schlepper / 4000	4370	0	Sanden	SD510	140	2	12	QC	16,4	16,4
851763N	Massey Ferguson	Schlepper / 5000	5425	0	Sanden	SD7H15	112	4	12		16	16
850883N	Massey Ferguson	Schlepper / 5000	5425	0	Sanden	SD510	140	2	12	QC	16,4	16,4
851763N	Massey Ferguson	Schlepper / 5000	5435	0	Sanden	SD7H15	112	4	12		16	16
850883N	Massey Ferguson	Schlepper / 5000	5435	0	Sanden	SD510	140	2	12	QC	16,4	16,4
851763N	Massey Ferguson	Schlepper / 5000	5445	0	Sanden	SD7H15	112	4	12		16	16
850883N	Massey Ferguson	Schlepper / 5000	5445	0	Sanden	SD510	140	2	12	QC	16,4	16,4
851763N	Massey Ferguson	Schlepper / 5000	5455	0	Sanden	SD7H15	112	4	12		16	16
850883N	Massey Ferguson	Schlepper / 5000	5455	0	Sanden	SD510	140	2	12	QC	16,4	16,4
851763N	Massey Ferguson	Schlepper / 5000	5460	0	Sanden	SD7H15	112	4	12		16	16



Dasis Nr.	Hersteller	Modell	Typ	KW	Herstellereinschränkung	Kompressor-ID	Riemenscheiben-Ø [mm]	Rippenanzahl	Spannung [V]	Zylinderkopf-ID (Kompressor)	Einlass-Ø [mm]	Auslass-Ø [mm]
850883N	Massey Ferguson	Schlepper / 5000	5460	0	Sanden	SD510	140	2	12	QC	16,4	16,4
850883N	Massey Ferguson	Schlepper / 5000	5465	0	Sanden	SD510	140	2	12	QC	16,4	16,4
851763N	Massey Ferguson	Schlepper / 5000	5470	0	Sanden	SD7H15	112	4	12		16	16
850883N	Massey Ferguson	Schlepper / 5000	5470	0	Sanden	SD510	140	2	12	QC	16,4	16,4
851763N	Massey Ferguson	Schlepper / 5000	5480	0	Sanden	SD7H15	112	4	12		16	16
850883N	Massey Ferguson	Schlepper / 5000	5480	0	Sanden	SD510	140	2	12	QC	16,4	16,4
850883N	Massey Ferguson	Schlepper / 6000	6120	0	Sanden	SD510	140	2	12	QC	16,4	16,4
850883N	Massey Ferguson	Schlepper / 6000	6130	0	Sanden	SD510	140	2	12	QC	16,4	16,4
850883N	Massey Ferguson	Schlepper / 6000	6140	0	Sanden	SD510	140	2	12	QC	16,4	16,4
850883N	Massey Ferguson	Schlepper / 6000	6150	0	Sanden	SD510	140	2	12	QC	16,4	16,4
850883N	Massey Ferguson	Schlepper / 6000	6160	0	Sanden	SD510	140	2	12	QC	16,4	16,4
850883N	Massey Ferguson	Schlepper / 6000	6170	0	Sanden	SD510	140	2	12	QC	16,4	16,4
850883N	Massey Ferguson	Schlepper / 6000	6180	0	Sanden	SD510	140	2	12	QC	16,4	16,4
850883N	Massey Ferguson	Schlepper / 6000	6190	0	Sanden	SD510	140	2	12	QC	16,4	16,4
850883N	Massey Ferguson	Schlepper / 6000	6235	0	Sanden	SD510	140	2	12	QC	16,4	16,4
850883N	Massey Ferguson	Schlepper / 6000	6245	0	Sanden	SD510	140	2	12	QC	16,4	16,4
850883N	Massey Ferguson	Schlepper / 6000	6255	0	Sanden	SD510	140	2	12	QC	16,4	16,4
850883N	Massey Ferguson	Schlepper / 6000	6260	0	Sanden	SD510	140	2	12	QC	16,4	16,4
850883N	Massey Ferguson	Schlepper / 6000	6265	0	Sanden	SD510	140	2	12	QC	16,4	16,4
850883N	Massey Ferguson	Schlepper / 6000	6270	0	Sanden	SD510	140	2	12	QC	16,4	16,4
850883N	Massey Ferguson	Schlepper / 6000	6280	0	Sanden	SD510	140	2	12	QC	16,4	16,4

Dasis Nr.	Hersteller	Modell	Typ	KW	Herstellereinschränkung	Kompressor-ID	Riemenscheiben-Ø [mm]	Rippenanzahl	Spannung [V]	Zylinderkopf-ID (Kompressor)	Einlass-Ø [mm]	Auslass-Ø [mm]
850883N	Massey Ferguson	Schlepper / 6000	6290	0	Sanden	SD510	140	2	12	QC	16,4	16,4
851763N	Massey Ferguson	Schlepper / 6000	6445	0	Sanden	SD7H15	112	4	12		16	16
851763N	Massey Ferguson	Schlepper / 6000	6455	0	Sanden	SD7H15	112	4	12		16	16
851763N	Massey Ferguson	Schlepper / 6000	6460	0	Sanden	SD7H15	112	4	12		16	16
851763N	Massey Ferguson	Schlepper / 6000	6465	0	Sanden	SD7H15	112	4	12		16	16
851713N	Massey Ferguson	Schlepper / 6000	6465	0	Sanden	SD7H15	120	6	12		17,4	14,4
851763N	Massey Ferguson	Schlepper / 6000	6470	0	Sanden	SD7H15	112	4	12		16	16
851763N	Massey Ferguson	Schlepper / 6000	6475	0	Sanden	SD7H15	112	4	12		16	16
851713N	Massey Ferguson	Schlepper / 6000	6475	0	Sanden	SD7H15	120	6	12		17,4	14,4
851763N	Massey Ferguson	Schlepper / 6000	6480	0	Sanden	SD7H15	112	4	12		16	16
851713N	Massey Ferguson	Schlepper / 6000	6480	0	Sanden	SD7H15	120	6	12		17,4	14,4
851763N	Massey Ferguson	Schlepper / 6000	6485	0	Sanden	SD7H15	112	4	12		16	16
851713N	Massey Ferguson	Schlepper / 6000	6485	0	Sanden	SD7H15	120	6	12		17,4	14,4
851763N	Massey Ferguson	Schlepper / 6000	6490	0	Sanden	SD7H15	112	4	12		16	16
851713N	Massey Ferguson	Schlepper / 6000	6490	0	Sanden	SD7H15	120	6	12		17,4	14,4
851763N	Massey Ferguson	Schlepper / 6000	6495	0	Sanden	SD7H15	112	4	12		16	16
851713N	Massey Ferguson	Schlepper / 6000	6495	0	Sanden	SD7H15	120	6	12		17,4	14,4
851763N	Massey Ferguson	Schlepper / 6000	6497	0	Sanden	SD7H15	112	4	12		16	16
851763N	Massey Ferguson	Schlepper / 6000	6499	0	Sanden	SD7H15	112	4	12		16	16
851763N	Massey Ferguson	Schlepper / 7000	7465	0	Sanden	SD7H15	112	4	12		16	16
851713N	Massey Ferguson	Schlepper / 7000	7465	0	Sanden	SD7H15	120	6	12		17,4	14,4

Dasis Nr.	Hersteller	Modell	Typ	KW	Herstellereinschränkung	Kompressor-ID	Riemenscheiben-Ø [mm]	Rippenanzahl	Spannung [V]	Zylinderkopf-ID (Kompressor)	Einlass-Ø [mm]	Auslass-Ø [mm]
851763N	Massey Ferguson	Schlepper / 7000	7475	0	Sanden	SD7H15	112	4	12		16	16
851713N	Massey Ferguson	Schlepper / 7000	7475	0	Sanden	SD7H15	120	6	12		17,4	14,4
851763N	Massey Ferguson	Schlepper / 7000	7480	0	Sanden	SD7H15	112	4	12		16	16
851713N	Massey Ferguson	Schlepper / 7000	7480	0	Sanden	SD7H15	120	6	12		17,4	14,4
851763N	Massey Ferguson	Schlepper / 7000	7485	0	Sanden	SD7H15	112	4	12		16	16
851713N	Massey Ferguson	Schlepper / 7000	7485	0	Sanden	SD7H15	120	6	12		17,4	14,4
851763N	Massey Ferguson	Schlepper / 7000	7490	0	Sanden	SD7H15	112	4	12		16	16
851713N	Massey Ferguson	Schlepper / 7000	7490	0	Sanden	SD7H15	120	6	12		17,4	14,4
851763N	Massey Ferguson	Schlepper / 7000	7495	0	Sanden	SD7H15	112	4	12		16	16
851713N	Massey Ferguson	Schlepper / 7000	7495	0	Sanden	SD7H15	120	6	12		17,4	14,4
851763N	Massey Ferguson	Schlepper / 7000	7495Räder3	0	Sanden	SD7H15	112	4	12		16	16
851713N	Massey Ferguson	Schlepper / 7000	7495Räder3	0	Sanden	SD7H15	120	6	12		17,4	14,4
850883N	Massey Ferguson	Schlepper / 8000	8110	0	Sanden	SD510	140	2	12	QC	16,4	16,4
850883N	Massey Ferguson	Schlepper / 8000	8120	0	Sanden	SD510	140	2	12	QC	16,4	16,4
850883N	Massey Ferguson	Schlepper / 8000	8130	0	Sanden	SD510	140	2	12	QC	16,4	16,4
850883N	Massey Ferguson	Schlepper / 8000	8140	0	Sanden	SD510	140	2	12	QC	16,4	16,4
850883N	Massey Ferguson	Schlepper / 8000	8150	0	Sanden	SD510	140	2	12	QC	16,4	16,4
850883N	Massey Ferguson	Schlepper / 8000	8160	0	Sanden	SD510	140	2	12	QC	16,4	16,4
850883N	Massey Ferguson	Schlepper / 8000	8170	0	Sanden	SD510	140	2	12	QC	16,4	16,4
850883N	Massey Ferguson	Schlepper / 8000	8180	0	Sanden	SD510	140	2	12	QC	16,4	16,4
850883N	Massey Ferguson	Schlepper / 8000	8210	0	Sanden	SD510	140	2	12	QC	16,4	16,4

Dasis Nr.	Hersteller	Modell	Typ	KW	Herstellereinschränkung	Kompressor-ID	Riemenscheiben-Ø [mm]	Rippenanzahl	Spannung [V]	Zylinderkopf-ID (Kompressor)	Einlass-Ø [mm]	Auslass-Ø [mm]
850883N	Massey Ferguson	Schlepper / 8000	8220	0	Sanden	SD510	140	2	12	QC	16,4	16,4
850883N	Massey Ferguson	Schlepper / 8000	8240	0	Sanden	SD510	140	2	12	QC	16,4	16,4
850883N	Massey Ferguson	Schlepper / 8000	8250	0	Sanden	SD510	140	2	12	QC	16,4	16,4
850883N	Massey Ferguson	Schlepper / 8000	8260	0	Sanden	SD510	140	2	12	QC	16,4	16,4
850883N	Massey Ferguson	Schlepper / 8000	8270	0	Sanden	SD510	140	2	12	QC	16,4	16,4
850883N	Massey Ferguson	Schlepper / 8000	8280	0	Sanden	SD510	140	2	12	QC	16,4	16,4
851763N	Massey Ferguson	Schlepper / 8000	8450	0	Sanden	SD7H15	112	4	12		16	16
851763N	Massey Ferguson	Schlepper / 8000	8460	0	Sanden	SD7H15	112	4	12		16	16
851763N	Massey Ferguson	Schlepper / 8000	8470	0	Sanden	SD7H15	112	4	12		16	16
851763N	Massey Ferguson	Schlepper / 8000	8480	0	Sanden	SD7H15	112	4	12		16	16
850892N	Massey Ferguson	Schlepper / 8000	8939	0	Sanden	7H15	132	2	12	MJ	15	15
850885N	Massey Ferguson	Schlepper / Dronningborg	24	0	Sanden	SD508	132	2	12	FL	16	14
850885N	Massey Ferguson	Schlepper / Dronningborg	29P	0	Sanden	SD508	132	2	12	FL	16	14
850885N	Massey Ferguson	Schlepper / Dronningborg	30	0	Sanden	SD508	132	2	12	FL	16	14
850885N	Massey Ferguson	Schlepper / Dronningborg	31P	0	Sanden	SD508	132	2	12	FL	16	14
850885N	Massey Ferguson	Schlepper / Dronningborg	32	0	Sanden	SD508	132	2	12	FL	16	14
850885N	Massey Ferguson	Schlepper / Dronningborg	34	0	Sanden	SD508	132	2	12	FL	16	14
850885N	Massey Ferguson	Schlepper / Dronningborg	36	0	Sanden	SD508	132	2	12	FL	16	14
850885N	Massey Ferguson	Schlepper / Dronningborg	38	0	Sanden	SD508	132	2	12	FL	16	14
850885N	Massey Ferguson	Schlepper / Dronningborg	40	0	Sanden	SD508	132	2	12	FL	16	14
850327N	Massey Ferguson	Schlepper Obst Wein / 3300F	3315F	0	Sanden	SD7B10	115	2	12		14,9	12,2

Dasis Nr.	Hersteller	Modell	Typ	KW	Herstellereinschränkung	Kompressor-ID	Riemenscheiben-Ø [mm]	Rippenanzahl	Spannung [V]	Zylinderkopf-ID (Kompressor)	Einlass-Ø [mm]	Auslass-Ø [mm]
850327N	Massey Ferguson	Schlepper Obst Wein / 3300F	3325F	0	Sanden	SD7B10	115	2	12		14,9	12,2
850327N	Massey Ferguson	Schlepper Obst Wein / 3300F	3330F	0	Sanden	SD7B10	115	2	12		14,9	12,2
850327N	Massey Ferguson	Schlepper Obst Wein / 3300F	3340F	0	Sanden	SD7B10	115	2	12		14,9	12,2
850327N	Massey Ferguson	Schlepper Obst Wein / 3300F	3350F	0	Sanden	SD7B10	115	2	12		14,9	12,2
850327N	Massey Ferguson	Schlepper Obst Wein / 3300F	3355F	0	Sanden	SD7B10	115	2	12		14,9	12,2
850327N	Massey Ferguson	Schlepper Obst Wein / 3300S	3315S	0	Sanden	SD7B10	115	2	12		14,9	12,2
850327N	Massey Ferguson	Schlepper Obst Wein / 3300S	3325S	0	Sanden	SD7B10	115	2	12		14,9	12,2
850327N	Massey Ferguson	Schlepper Obst Wein / 3300S	3330S	0	Sanden	SD7B10	115	2	12		14,9	12,2
850327N	Massey Ferguson	Schlepper Obst Wein / 3300S	3340S	0	Sanden	SD7B10	115	2	12		14,9	12,2
850327N	Massey Ferguson	Schlepper Obst Wein / 3300S	3350S	0	Sanden	SD7B10	115	2	12		14,9	12,2
850327N	Massey Ferguson	Schlepper Obst Wein / 3300S	3355S	0	Sanden	SD7B10	115	2	12		14,9	12,2
850327N	Massey Ferguson	Schlepper Obst Wein / 3300V	3315V	0	Sanden	SD7B10	115	2	12		14,9	12,2
850327N	Massey Ferguson	Schlepper Obst Wein / 3300V	3325V	0	Sanden	SD7B10	115	2	12		14,9	12,2
850327N	Massey Ferguson	Schlepper Obst Wein / 3300V	3330V	0	Sanden	SD7B10	115	2	12		14,9	12,2
850327N	Massey Ferguson	Schlepper Obst Wein / 3300V	3340V	0	Sanden	SD7B10	115	2	12		14,9	12,2
850327N	Massey Ferguson	Schlepper Obst Wein / 3300V	3350V	0	Sanden	SD7B10	115	2	12		14,9	12,2
850327N	Massey Ferguson	Schlepper Obst Wein / 3300V	3355V	0	Sanden	SD7B10	115	2	12		14,9	12,2
850327N	Massey Ferguson	Schlepper Obst Wein / 3400F	3425F	0	Sanden	SD7B10	115	2	12		14,9	12,2
850327N	Massey Ferguson	Schlepper Obst Wein / 3400F	3435F	0	Sanden	SD7B10	115	2	12		14,9	12,2
850327N	Massey Ferguson	Schlepper Obst Wein / 3400F	3445F	0	Sanden	SD7B10	115	2	12		14,9	12,2
850327N	Massey Ferguson	Schlepper Obst Wein / 3400F	3455F	0	Sanden	SD7B10	115	2	12		14,9	12,2

Dasis Nr.	Hersteller	Modell	Typ	KW	Herstellereinschränkung	Kompressor-ID	Riemenscheiben-Ø [mm]	Rippenanzahl	Spannung [V]	Zylinderkopf-ID (Kompressor)	Einlass-Ø [mm]	Auslass-Ø [mm]
850327N	Massey Ferguson	Schlepper Obst Wein / 3400S	3425S	0	Sanden	SD7B10	115	2	12		14,9	12,2
850327N	Massey Ferguson	Schlepper Obst Wein / 3400S	3435S	0	Sanden	SD7B10	115	2	12		14,9	12,2
850327N	Massey Ferguson	Schlepper Obst Wein / 3400S	3445S	0	Sanden	SD7B10	115	2	12		14,9	12,2
850327N	Massey Ferguson	Schlepper Obst Wein / 3400S	3455S	0	Sanden	SD7B10	115	2	12		14,9	12,2
851763N	Massey Ferguson	Schlepper Obst Wein / 8400	8450	0	Sanden	SD7H15	112	4	12		16	16
851763N	Massey Ferguson	Schlepper Obst Wein / 8400	8460	0	Sanden	SD7H15	112	4	12		16	16
851763N	Massey Ferguson	Schlepper Obst Wein / 8400	8470	0	Sanden	SD7H15	112	4	12		16	16
851763N	Massey Ferguson	Schlepper Obst Wein / 8400	8480	0	Sanden	SD7H15	112	4	12		16	16
851714N	MC Cormick	Schlepper / CMAX	85	0	Delphi	SP-10	121	2	12		18	15
850874N	MC Cormick	Schlepper / CX	70	0	Sanden	SD7H15HD	152	2	12	MD	14,5	14,5
850874N	MC Cormick	Schlepper / CX	80	0	Sanden	SD7H15HD	152	2	12	MD	14,5	14,5
850874N	MC Cormick	Schlepper / CX	90	0	Sanden	SD7H15HD	152	2	12	MD	14,5	14,5
850874N	MC Cormick	Schlepper / CX	100	0	Sanden	SD7H15HD	152	2	12	MD	14,5	14,5
851714N	MC Cormick	Schlepper / F	85	0	Delphi	SP-10	121	2	12		18	15
851714N	MC Cormick	Schlepper / F	90	0	Delphi	SP-10	121	2	12		18	15
850874N	MC Cormick	Schlepper / MC	80	0	Sanden	SD7H15HD	152	2	12	MD	14,5	14,5
850874N	MC Cormick	Schlepper / MC	90	0	Sanden	SD7H15HD	152	2	12	MD	14,5	14,5
850874N	MC Cormick	Schlepper / MC	100	0	Sanden	SD7H15HD	152	2	12	MD	14,5	14,5
850874N	MC Cormick	Schlepper / MC	115	0	Sanden	SD7H15HD	152	2	12	MD	14,5	14,5
850874N	MC Cormick	Schlepper / MC	120	0	Sanden	SD7H15HD	152	2	12	MD	14,5	14,5
850874N	MC Cormick	Schlepper / MC	135	0	Sanden	SD7H15HD	152	2	12	MD	14,5	14,5
850874N	MC Cormick	Schlepper / MTX	110	0	Sanden	SD7H15HD	152	2	12	MD	14,5	14,5
851772N	MC Cormick	Schlepper / MTX	120	0	Sanden	SD7H15	120	4	12		17	17
850874N	MC Cormick	Schlepper / MTX	125	0	Sanden	SD7H15HD	152	2	12	MD	14,5	14,5
851772N	MC Cormick	Schlepper / MTX	135	0	Sanden	SD7H15	120	4	12		17	17
850874N	MC Cormick	Schlepper / MTX	140	0	Sanden	SD7H15HD	152	2	12	MD	14,5	14,5
851772N	MC Cormick	Schlepper / MTX	150	0	Sanden	SD7H15	120	4	12		17	17

Dasis Nr.	Hersteller	Modell	Typ	KW	Herstellereinschränkung	Kompressor-ID	Riemenscheiben-Ø [mm]	Rippenanzahl	Spannung [V]	Zylinderkopf-ID (Kompressor)	Einlass-Ø [mm]	Auslass-Ø [mm]
850874N	MC Cormick	Schlepper / MTX	155	0	Sanden	SD7H15HD	152	2	12	MD	14,5	14,5
851772N	MC Cormick	Schlepper / MTX	165	0	Sanden	SD7H15	120	4	12		17	17
850874N	MC Cormick	Schlepper / MTX	175	0	Sanden	SD7H15HD	152	2	12	MD	14,5	14,5
851772N	MC Cormick	Schlepper / MTX	185	0	Sanden	SD7H15	120	4	12		17	17
851712N	MC Cormick	Schlepper / XTX	185	0	Delphi	V5	132	2	12			
851765N	MC Cormick	Schlepper / XTX	200	0	Sanden	SD7H15	145	4	12		16	18
851765N	MC Cormick	Schlepper / XTX	215	0	Sanden	SD7H15	145	4	12		16	18
851714N	MC Cormick	Teleskoplader / GXH	50	0	Delphi	SP-10	121	2	12		18	15
851714N	MC Cormick	Teleskoplader / GXH	G50H	0	Delphi	SP-10	121	2	12		18	15
851714N	Merlo	Teleskoplader	25.9	0	Delphi	SP-10	121	2	12		18	15
851712N	Merlo	Teleskoplader	25.9	0	Delphi	V5	132	2	12			
851714N	Merlo	Teleskoplader	27.9	0	Delphi	SP-10	121	2	12		18	15
851712N	Merlo	Teleskoplader	27.9	0	Delphi	V5	132	2	12			
851714N	Merlo	Teleskoplader	28.7	0	Delphi	SP-10	121	2	12		18	15
851712N	Merlo	Teleskoplader	28.7	0	Delphi	V5	132	2	12			
851714N	Merlo	Teleskoplader	28.9	0	Delphi	SP-10	121	2	12		18	15
851712N	Merlo	Teleskoplader	28.9	0	Delphi	V5	132	2	12			
851714N	Merlo	Teleskoplader	30.7	0	Delphi	SP-10	121	2	12		18	15
851712N	Merlo	Teleskoplader	30.7	0	Delphi	V5	132	2	12			
851714N	Merlo	Teleskoplader	32.7	0	Delphi	SP-10	121	2	12		18	15
851712N	Merlo	Teleskoplader	32.7	0	Delphi	V5	132	2	12			
851714N	Merlo	Teleskoplader	35.7	0	Delphi	SP-10	121	2	12		18	15
851712N	Merlo	Teleskoplader	35.7	0	Delphi	V5	132	2	12			
851714N	Merlo	Teleskoplader	40.8	0	Delphi	SP-10	121	2	12		18	15
851712N	Merlo	Teleskoplader	40.8	0	Delphi	V5	132	2	12			
850574N	Merlo	Teleskoplader	KabineK	0	Denso	5SL12CJ	135	6	12			
850422N	NEW HOLLAND	Baggerlader / 550-575E	550	0	York	R209/210R	ohne Riemenscheibe	ohne Riemenscheibe			13,5	13,5
850352N	NEW HOLLAND	Baggerlader / 550-575E	550	0	York	T209/210L					14,9	14,9
858454N	NEW HOLLAND	Baggerlader / 550-575E	555	0	Sanden	SD510	132	2	12	M	14	13

Dasis Nr.	Hersteller	Modell	Typ	KW	Herstellereinschränkung	Kompressor-ID	Riemenscheiben-Ø [mm]	Rippenanzahl	Spannung [V]	Zylinderkopf-ID (Kompressor)	Einlass-Ø [mm]	Auslass-Ø [mm]
850422N	NEW HOLLAND	Baggerlader / 550-575E	555	0	York	R209/210R	ohne Riemenscheibe	ohne Riemenscheibe			13,5	13,5
850352N	NEW HOLLAND	Baggerlader / 550-575E	555	0	York	T209/210L					14,9	14,9
850422N	NEW HOLLAND	Baggerlader / 550-575E	555A	0	York	R209/210R	ohne Riemenscheibe	ohne Riemenscheibe			13,5	13,5
850352N	NEW HOLLAND	Baggerlader / 550-575E	555A	0	York	T209/210L					14,9	14,9
850422N	NEW HOLLAND	Baggerlader / 550-575E	555B	0	York	R209/210R	ohne Riemenscheibe	ohne Riemenscheibe			13,5	13,5
850352N	NEW HOLLAND	Baggerlader / 550-575E	555B	0	York	T209/210L					14,9	14,9
851733N	NEW HOLLAND	Baggerlader / 550-575E	555E	0	Sanden	SD7H15HD	140	2	12	GV	16	16
858454N	NEW HOLLAND	Baggerlader / 550-575E	575	0	Sanden	SD510	132	2	12	M	14	13
851733N	NEW HOLLAND	Baggerlader / 550-575E	575E	0	Sanden	SD7H15HD	140	2	12	GV	16	16
858454N	NEW HOLLAND	Baggerlader / 655-755A	655	0	Sanden	SD510	132	2	12	M	14	13
850422N	NEW HOLLAND	Baggerlader / 655-755A	655	0	York	R209/210R	ohne Riemenscheibe	ohne Riemenscheibe			13,5	13,5
850352N	NEW HOLLAND	Baggerlader / 655-755A	655	0	York	T209/210L					14,9	14,9
850422N	NEW HOLLAND	Baggerlader / 655-755A	655A	0	York	R209/210R	ohne Riemenscheibe	ohne Riemenscheibe			13,5	13,5
850352N	NEW HOLLAND	Baggerlader / 655-755A	655A	0	York	T209/210L					14,9	14,9
851733N	NEW HOLLAND	Baggerlader / 655-755A	655E	0	Sanden	SD7H15HD	140	2	12	GV	16	16
850327N	NEW HOLLAND	Baggerlader / 655-755A	675	0	Sanden	SD7B10	115	2	12		14,9	12,2
851733N	NEW HOLLAND	Baggerlader / 655-755A	675	0	Sanden	SD7H15HD	140	2	12	GV	16	16
858454N	NEW HOLLAND	Baggerlader / 655-755A	675	0	Sanden	SD510	132	2	12	M	14	13
850327N	NEW HOLLAND	Baggerlader / 655-755A	675E	0	Sanden	SD7B10	115	2	12		14,9	12,2
851733N	NEW HOLLAND	Baggerlader / 655-755A	675E	0	Sanden	SD7H15HD	140	2	12	GV	16	16
850422N	NEW HOLLAND	Baggerlader / 655-755A	755A	0	York	R209/210R	ohne Riemenscheibe	ohne Riemenscheibe			13,5	13,5



Dasis Nr.	Hersteller	Modell	Typ	KW	Herstellereinschränkung	Kompressor-ID	Riemenscheiben-Ø [mm]	Rippenanzahl	Spannung [V]	Zylinderkopf-ID (Kompressor)	Einlass-Ø [mm]	Auslass-Ø [mm]
850352N	NEW HOLLAND	Baggerlader / 655-755A	755A	0	York	T209/210L					14,9	14,9
851733N	NEW HOLLAND	Baggerlader / LB	75	0	Sanden	SD7H15HD	140	2	12	GV	16	16
851733N	NEW HOLLAND	Baggerlader / LB	90	0	Sanden	SD7H15HD	140	2	12	GV	16	16
851733N	NEW HOLLAND	Baggerlader / LB	110	0	Sanden	SD7H15HD	140	2	12	GV	16	16
850352N	NEW HOLLAND	Baggerlader / TR	96	0	York	T209/210L					14,9	14,9
852922N	NEW HOLLAND	Kompaktlader	L218	0	Sanden	SD5H11	152	6	12	FL		
852922N	NEW HOLLAND	Kompaktlader	L220	0	Sanden	SD5H11	152	6	12	FL		
850422N	NEW HOLLAND	Mähdrescher / 8000	8030	0	York	R209/210R	ohne Riemenscheibe	ohne Riemenscheibe			13,5	13,5
850352N	NEW HOLLAND	Mähdrescher / 8000	8030	0	York	T209/210L					14,9	14,9
850422N	NEW HOLLAND	Mähdrescher / 8000	8040	0	York	R209/210R	ohne Riemenscheibe	ohne Riemenscheibe			13,5	13,5
850352N	NEW HOLLAND	Mähdrescher / 8000	8040	0	York	T209/210L					14,9	14,9
850422N	NEW HOLLAND	Mähdrescher / 8000	8050	0	York	R209/210R	ohne Riemenscheibe	ohne Riemenscheibe			13,5	13,5
850352N	NEW HOLLAND	Mähdrescher / 8000	8050	0	York	T209/210L					14,9	14,9
850422N	NEW HOLLAND	Mähdrescher / 8000	8055	0	York	R209/210R	ohne Riemenscheibe	ohne Riemenscheibe			13,5	13,5
850352N	NEW HOLLAND	Mähdrescher / 8000	8055	0	York	T209/210L					14,9	14,9
850422N	NEW HOLLAND	Mähdrescher / 8000	8060	0	York	R209/210R	ohne Riemenscheibe	ohne Riemenscheibe			13,5	13,5
850352N	NEW HOLLAND	Mähdrescher / 8000	8060	0	York	T209/210L					14,9	14,9
850422N	NEW HOLLAND	Mähdrescher / 8000	8070	0	York	R209/210R	ohne Riemenscheibe	ohne Riemenscheibe			13,5	13,5
850352N	NEW HOLLAND	Mähdrescher / 8000	8070	0	York	T209/210L					14,9	14,9
850422N	NEW HOLLAND	Mähdrescher / 8000	8080	0	York	R209/210R	ohne Riemenscheibe	ohne Riemenscheibe			13,5	13,5
850352N	NEW HOLLAND	Mähdrescher / 8000	8080	0	York	T209/210L					14,9	14,9
851769N	NEW HOLLAND	Mähdrescher / CR	920	0	Sanden	SD7H15	119	4	12			
851769N	NEW HOLLAND	Mähdrescher / CR	940	0	Sanden	SD7H15	119	4	12			

Dasis Nr.	Hersteller	Modell	Typ	KW	Herstellereinschränkung	Kompressor-ID	Riemenscheiben-Ø [mm]	Rippenanzahl	Spannung [V]	Zylinderkopf-ID (Kompressor)	Einlass-Ø [mm]	Auslass-Ø [mm]
851769N	NEW HOLLAND	Mähdrescher / CR	960	0	Sanden	SD7H15	119	4	12			
851769N	NEW HOLLAND	Mähdrescher / CR	970	0	Sanden	SD7H15	119	4	12			
851769N	NEW HOLLAND	Mähdrescher / CR	980	0	Sanden	SD7H15	119	4	12			
851716N	NEW HOLLAND	Mähdrescher / CS	520	0	Sanden	SD7H15	119	8	12		14	16
851716N	NEW HOLLAND	Mähdrescher / CS	540	0	Sanden	SD7H15	119	8	12		14	16
851716N	NEW HOLLAND	Mähdrescher / CS	640	0	Sanden	SD7H15	119	8	12		14	16
851716N	NEW HOLLAND	Mähdrescher / CS	660	0	Sanden	SD7H15	119	8	12		14	16
851716N	NEW HOLLAND	Mähdrescher / CX	720	0	Sanden	SD7H15	119	8	12		14	16
851716N	NEW HOLLAND	Mähdrescher / CX	740	0	Sanden	SD7H15	119	8	12		14	16
851716N	NEW HOLLAND	Mähdrescher / CX	760	0	Sanden	SD7H15	119	8	12		14	16
851716N	NEW HOLLAND	Mähdrescher / CX	780	0	Sanden	SD7H15	119	8	12		14	16
851716N	NEW HOLLAND	Mähdrescher / CX	820	0	Sanden	SD7H15	119	8	12		14	16
851716N	NEW HOLLAND	Mähdrescher / CX	840	0	Sanden	SD7H15	119	8	12		14	16
851716N	NEW HOLLAND	Mähdrescher / CX	860	0	Sanden	SD7H15	119	8	12		14	16
851769N	NEW HOLLAND	Mähdrescher / CX	880	0	Sanden	SD7H15	119	4	12			
851741N	NEW HOLLAND	Mähdrescher / LMA	430	0	Sanden	SD7H15	135	1	12		14	14
851741N	NEW HOLLAND	Mähdrescher / LMA	435	0	Sanden	SD7H15	135	1	12		14	14
851741N	NEW HOLLAND	Mähdrescher / LMA	445	0	Sanden	SD7H15	135	1	12		14	14
850875N	NEW HOLLAND	Mähdrescher / TC	52	0	Sanden	SD7H15	132	2	12	KG		
850875N	NEW HOLLAND	Mähdrescher / TC	54	0	Sanden	SD7H15	132	2	12	KG		
850875N	NEW HOLLAND	Mähdrescher / TC	56	0	Sanden	SD7H15	132	2	12	KG		

Dasis Nr.	Hersteller	Modell	Typ	KW	Herstellereinschränkung	Kompressor-ID	Riemenscheiben-Ø [mm]	Rippenanzahl	Spannung [V]	Zylinderkopf-ID (Kompressor)	Einlass-Ø [mm]	Auslass-Ø [mm]
850873N	NEW HOLLAND	Mähdrescher / TF	42	0	Sanden	SD510HD	132	2	12	M	13,5	13,5
850422N	NEW HOLLAND	Mähdrescher / TF	42	0	York	R209/210R	ohne Riemenscheibe	ohne Riemenscheibe			13,5	13,5
850873N	NEW HOLLAND	Mähdrescher / TF	44	0	Sanden	SD510HD	132	2	12	M	13,5	13,5
850422N	NEW HOLLAND	Mähdrescher / TF	44	0	York	R209/210R	ohne Riemenscheibe	ohne Riemenscheibe			13,5	13,5
850873N	NEW HOLLAND	Mähdrescher / TF	46	0	Sanden	SD510HD	132	2	12	M	13,5	13,5
850422N	NEW HOLLAND	Mähdrescher / TF	46	0	York	R209/210R	ohne Riemenscheibe	ohne Riemenscheibe			13,5	13,5
850422N	NEW HOLLAND	Mähdrescher / TF	76	0	York	R209/210R	ohne Riemenscheibe	ohne Riemenscheibe			13,5	13,5
850422N	NEW HOLLAND	Mähdrescher / TF	78	0	York	R209/210R	ohne Riemenscheibe	ohne Riemenscheibe			13,5	13,5
850422N	NEW HOLLAND	Mähdrescher / TR	70	0	York	R209/210R	ohne Riemenscheibe	ohne Riemenscheibe			13,5	13,5
850422N	NEW HOLLAND	Mähdrescher / TR	75	0	York	R209/210R	ohne Riemenscheibe	ohne Riemenscheibe			13,5	13,5
850873N	NEW HOLLAND	Mähdrescher / TR	76	0	Sanden	SD510HD	132	2	12	M	13,5	13,5
850422N	NEW HOLLAND	Mähdrescher / TR	76	0	York	R209/210R	ohne Riemenscheibe	ohne Riemenscheibe			13,5	13,5
850873N	NEW HOLLAND	Mähdrescher / TR	85	0	Sanden	SD510HD	132	2	12	M	13,5	13,5
850422N	NEW HOLLAND	Mähdrescher / TR	85	0	York	R209/210R	ohne Riemenscheibe	ohne Riemenscheibe			13,5	13,5
850873N	NEW HOLLAND	Mähdrescher / TR	86	0	Sanden	SD510HD	132	2	12	M	13,5	13,5
850422N	NEW HOLLAND	Mähdrescher / TR	86	0	York	R209/210R	ohne Riemenscheibe	ohne Riemenscheibe			13,5	13,5
850873N	NEW HOLLAND	Mähdrescher / TR	98	0	Sanden	SD510HD	132	2	12	M	13,5	13,5
850422N	NEW HOLLAND	Mähdrescher / TR	98	0	York	R209/210R	ohne Riemenscheibe	ohne Riemenscheibe			13,5	13,5
850889N	NEW HOLLAND	Schlepper / 670-8970	8670	0	Sanden	SD7H15	133	8	12	KC	13	15
850889N	NEW HOLLAND	Schlepper / 670-8970	8770	0	Sanden	SD7H15	133	8	12	KC	13	15
850889N	NEW HOLLAND	Schlepper / 670-8970	8870	0	Sanden	SD7H15	133	8	12	KC	13	15

Dasis Nr.	Hersteller	Modell	Typ	KW	Herstellereinschränkung	Kompressor-ID	Riemenscheiben-Ø [mm]	Rippenanzahl	Spannung [V]	Zylinderkopf-ID (Kompressor)	Einlass-Ø [mm]	Auslass-Ø [mm]
850889N	NEW HOLLAND	Schlepper / 670-8970	8970	0	Sanden	SD7H15	133	8	12	KC	13	15
850422N	NEW HOLLAND	Schlepper / 1905-2405	1905	0	York	R209/210R	ohne Riemenscheibe	ohne Riemenscheibe			13,5	13,5
850422N	NEW HOLLAND	Schlepper / 1905-2405	2205	0	York	R209/210R	ohne Riemenscheibe	ohne Riemenscheibe			13,5	13,5
850422N	NEW HOLLAND	Schlepper / 1905-2405	2305	0	York	R209/210R	ohne Riemenscheibe	ohne Riemenscheibe			13,5	13,5
850422N	NEW HOLLAND	Schlepper / 1905-2405	2405	0	York	R209/210R	ohne Riemenscheibe	ohne Riemenscheibe			13,5	13,5
850879N	NEW HOLLAND	Schlepper / 2110-8210	2310	0	Sanden	SD5H14	132	2	12	K	16	12
850408N	NEW HOLLAND	Schlepper / 2110-8210	2310	0	Tecumseh	HG850-1000					25	25
850879N	NEW HOLLAND	Schlepper / 2110-8210	2610	0	Sanden	SD5H14	132	2	12	K	16	12
850408N	NEW HOLLAND	Schlepper / 2110-8210	2610	0	Tecumseh	HG850-1000					25	25
850879N	NEW HOLLAND	Schlepper / 2110-8210	2810	0	Sanden	SD5H14	132	2	12	K	16	12
850408N	NEW HOLLAND	Schlepper / 2110-8210	2810	0	Tecumseh	HG850-1000					25	25
850879N	NEW HOLLAND	Schlepper / 2110-8210	2910	0	Sanden	SD5H14	132	2	12	K	16	12
850408N	NEW HOLLAND	Schlepper / 2110-8210	2910	0	Tecumseh	HG850-1000					25	25
850879N	NEW HOLLAND	Schlepper / 2110-8210	3310	0	Sanden	SD5H14	132	2	12	K	16	12
850408N	NEW HOLLAND	Schlepper / 2110-8210	3310	0	Tecumseh	HG850-1000					25	25
850879N	NEW HOLLAND	Schlepper / 2110-8210	3610	0	Sanden	SD5H14	132	2	12	K	16	12
850408N	NEW HOLLAND	Schlepper / 2110-8210	3610	0	Tecumseh	HG850-1000					25	25
850879N	NEW HOLLAND	Schlepper / 2110-8210	3910	0	Sanden	SD5H14	132	2	12	K	16	12
850408N	NEW HOLLAND	Schlepper / 2110-8210	3910	0	Tecumseh	HG850-1000					25	25
850879N	NEW HOLLAND	Schlepper / 2110-8210	4110	0	Sanden	SD5H14	132	2	12	K	16	12
850408N	NEW HOLLAND	Schlepper / 2110-8210	4110	0	Tecumseh	HG850-1000					25	25

Dasis Nr.	Hersteller	Modell	Typ	KW	Herstellereinschränkung	Kompressor-ID	Riemenscheiben-Ø [mm]	Rippenanzahl	Spannung [V]	Zylinderkopf-ID (Kompressor)	Einlass-Ø [mm]	Auslass-Ø [mm]
850879N	NEW HOLLAND	Schlepper / 2110-8210	4610	0	Sanden	SD5H14	132	2	12	K	16	12
850408N	NEW HOLLAND	Schlepper / 2110-8210	4610	0	Tecumseh	HG850-1000					25	25
850879N	NEW HOLLAND	Schlepper / 2110-8210	5110	0	Sanden	SD5H14	132	2	12	K	16	12
850408N	NEW HOLLAND	Schlepper / 2110-8210	5110	0	Tecumseh	HG850-1000					25	25
850879N	NEW HOLLAND	Schlepper / 2110-8210	5610	0	Sanden	SD5H14	132	2	12	K	16	12
850408N	NEW HOLLAND	Schlepper / 2110-8210	5610	0	Tecumseh	HG850-1000					25	25
850879N	NEW HOLLAND	Schlepper / 2110-8210	5710	0	Sanden	SD5H14	132	2	12	K	16	12
850408N	NEW HOLLAND	Schlepper / 2110-8210	5710	0	Tecumseh	HG850-1000					25	25
850879N	NEW HOLLAND	Schlepper / 2110-8210	5900	0	Sanden	SD5H14	132	2	12	K	16	12
850408N	NEW HOLLAND	Schlepper / 2110-8210	5900	0	Tecumseh	HG850-1000					25	25
850879N	NEW HOLLAND	Schlepper / 2110-8210	6410	0	Sanden	SD5H14	132	2	12	K	16	12
850408N	NEW HOLLAND	Schlepper / 2110-8210	6410	0	Tecumseh	HG850-1000					25	25
850879N	NEW HOLLAND	Schlepper / 2110-8210	6610	0	Sanden	SD5H14	132	2	12	K	16	12
850408N	NEW HOLLAND	Schlepper / 2110-8210	6610	0	Tecumseh	HG850-1000					25	25
850879N	NEW HOLLAND	Schlepper / 2110-8210	6710	0	Sanden	SD5H14	132	2	12	K	16	12
850408N	NEW HOLLAND	Schlepper / 2110-8210	6710	0	Tecumseh	HG850-1000					25	25
850879N	NEW HOLLAND	Schlepper / 2110-8210	6810	0	Sanden	SD5H14	132	2	12	K	16	12
850408N	NEW HOLLAND	Schlepper / 2110-8210	6810	0	Tecumseh	HG850-1000					25	25
850879N	NEW HOLLAND	Schlepper / 2110-8210	7410	0	Sanden	SD5H14	132	2	12	K	16	12
850408N	NEW HOLLAND	Schlepper / 2110-8210	7410	0	Tecumseh	HG850-1000					25	25
850879N	NEW HOLLAND	Schlepper / 2110-8210	7610	0	Sanden	SD5H14	132	2	12	K	16	12

Dasis Nr.	Hersteller	Modell	Typ	KW	Herstellereinschränkung	Kompressor-ID	Riemenscheiben-Ø [mm]	Rippenanzahl	Spannung [V]	Zylinderkopf-ID (Kompressor)	Einlass-Ø [mm]	Auslass-Ø [mm]
850408N	NEW HOLLAND	Schlepper / 2110-8210	7610	0	Tecumseh	HG850-1000					25	25
850879N	NEW HOLLAND	Schlepper / 2110-8210	7710	0	Sanden	SD5H14	132	2	12	K	16	12
850408N	NEW HOLLAND	Schlepper / 2110-8210	7710	0	Tecumseh	HG850-1000					25	25
850879N	NEW HOLLAND	Schlepper / 2110-8210	7810	0	Sanden	SD5H14	132	2	12	K	16	12
850408N	NEW HOLLAND	Schlepper / 2110-8210	7810	0	Tecumseh	HG850-1000					25	25
850879N	NEW HOLLAND	Schlepper / 2110-8210	7910	0	Sanden	SD5H14	132	2	12	K	16	12
850408N	NEW HOLLAND	Schlepper / 2110-8210	7910	0	Tecumseh	HG850-1000					25	25
850879N	NEW HOLLAND	Schlepper / 2110-8210	8210	0	Sanden	SD5H14	132	2	12	K	16	12
850408N	NEW HOLLAND	Schlepper / 2110-8210	8210	0	Tecumseh	HG850-1000					25	25
850879N	NEW HOLLAND	Schlepper / 3230-8930	3230	0	Sanden	SD5H14	132	2	12	K	16	12
850879N	NEW HOLLAND	Schlepper / 3230-8930	3430	0	Sanden	SD5H14	132	2	12	K	16	12
850879N	NEW HOLLAND	Schlepper / 3230-8930	3930	0	Sanden	SD5H14	132	2	12	K	16	12
850879N	NEW HOLLAND	Schlepper / 3230-8930	3930H	0	Sanden	SD5H14	132	2	12	K	16	12
850879N	NEW HOLLAND	Schlepper / 3230-8930	4130	0	Sanden	SD5H14	132	2	12	K	16	12
850879N	NEW HOLLAND	Schlepper / 3230-8930	4330	0	Sanden	SD5H14	132	2	12	K	16	12
850879N	NEW HOLLAND	Schlepper / 3230-8930	4630	0	Sanden	SD5H14	132	2	12	K	16	12
850879N	NEW HOLLAND	Schlepper / 3230-8930	4830	0	Sanden	SD5H14	132	2	12	K	16	12
850879N	NEW HOLLAND	Schlepper / 3230-8930	5030	0	Sanden	SD5H14	132	2	12	K	16	12
850879N	NEW HOLLAND	Schlepper / 3230-8930	8530	0	Sanden	SD5H14	132	2	12	K	16	12
850879N	NEW HOLLAND	Schlepper / 3230-8930	8630	0	Sanden	SD5H14	132	2	12	K	16	12
850879N	NEW HOLLAND	Schlepper / 3230-8930	8730	0	Sanden	SD5H14	132	2	12	K	16	12

Dasis Nr.	Hersteller	Modell	Typ	KW	Herstellereinschränkung	Kompressor-ID	Riemenscheiben-Ø [mm]	Rippenanzahl	Spannung [V]	Zylinderkopf-ID (Kompressor)	Einlass-Ø [mm]	Auslass-Ø [mm]
850879N	NEW HOLLAND	Schlepper / 3230-8930	8830	0	Sanden	SD5H14	132	2	12	K	16	12
851724N	NEW HOLLAND	Schlepper / 3435-7635	3435	0								
851724N	NEW HOLLAND	Schlepper / 3435-7635	3935	0								
851724N	NEW HOLLAND	Schlepper / 3435-7635	4135	0								
851724N	NEW HOLLAND	Schlepper / 3435-7635	4635	0								
851724N	NEW HOLLAND	Schlepper / 3435-7635	4835	0								
851724N	NEW HOLLAND	Schlepper / 3435-7635	5635	0								
851724N	NEW HOLLAND	Schlepper / 3435-7635	6635	0								
851724N	NEW HOLLAND	Schlepper / 3435-7635	7635	0								
850879N	NEW HOLLAND	Schlepper /4110-8210	5110	0	Sanden	SD5H14	132	2	12	K	16	12
850408N	NEW HOLLAND	Schlepper /4110-8210	5110	0	Tecumseh	HG850-1000					25	25
850879N	NEW HOLLAND	Schlepper /4110-8210	5610	0	Sanden	SD5H14	132	2	12	K	16	12
850408N	NEW HOLLAND	Schlepper /4110-8210	5610	0	Tecumseh	HG850-1000					25	25
850879N	NEW HOLLAND	Schlepper /4110-8210	6410	0	Sanden	SD5H14	132	2	12	K	16	12
850408N	NEW HOLLAND	Schlepper /4110-8210	6410	0	Tecumseh	HG850-1000					25	25
850879N	NEW HOLLAND	Schlepper /4110-8210	6610	0	Sanden	SD5H14	132	2	12	K	16	12
850408N	NEW HOLLAND	Schlepper /4110-8210	6610	0	Tecumseh	HG850-1000					25	25
850879N	NEW HOLLAND	Schlepper /4110-8210	6810	0	Sanden	SD5H14	132	2	12	K	16	12
850408N	NEW HOLLAND	Schlepper /4110-8210	6810	0	Tecumseh	HG850-1000					25	25
850879N	NEW HOLLAND	Schlepper /4110-8210	7410	0	Sanden	SD5H14	132	2	12	K	16	12
850408N	NEW HOLLAND	Schlepper /4110-8210	7410	0	Tecumseh	HG850-1000					25	25

Dasis Nr.	Hersteller	Modell	Typ	KW	Herstellereinschränkung	Kompressor-ID	Riemenscheiben-Ø [mm]	Rippenanzahl	Spannung [V]	Zylinderkopf-ID (Kompressor)	Einlass-Ø [mm]	Auslass-Ø [mm]
850879N	NEW HOLLAND	Schlepper /4110-8210	7610	0	Sanden	SD5H14	132	2	12	K	16	12
850408N	NEW HOLLAND	Schlepper /4110-8210	7610	0	Tecumseh	HG850-1000					25	25
850879N	NEW HOLLAND	Schlepper /4110-8210	7710	0	Sanden	SD5H14	132	2	12	K	16	12
850408N	NEW HOLLAND	Schlepper /4110-8210	7710	0	Tecumseh	HG850-1000					25	25
850879N	NEW HOLLAND	Schlepper /4110-8210	7810	0	Sanden	SD5H14	132	2	12	K	16	12
850408N	NEW HOLLAND	Schlepper /4110-8210	7810	0	Tecumseh	HG850-1000					25	25
850879N	NEW HOLLAND	Schlepper /4110-8210	7910	0	Sanden	SD5H14	132	2	12	K	16	12
850408N	NEW HOLLAND	Schlepper /4110-8210	7910	0	Tecumseh	HG850-1000					25	25
850879N	NEW HOLLAND	Schlepper /4110-8210	8210	0	Sanden	SD5H14	132	2	12	K	16	12
850408N	NEW HOLLAND	Schlepper /4110-8210	8210	0	Tecumseh	HG850-1000					25	25
850887N	NEW HOLLAND	Schlepper / 4140-8340	5640	0	Sanden	SD7H15	119	6	12	GV	16	12
851711N	NEW HOLLAND	Schlepper / 4140-8340	5640	0	Sanden	SD7H15	119	8	12	JE	16	12
850886N	NEW HOLLAND	Schlepper / 4140-8340	5640	0	Sanden	SD510	125	6	12	UB	11	15
850887N	NEW HOLLAND	Schlepper / 4140-8340	6640	0	Sanden	SD7H15	119	6	12	GV	16	12
851711N	NEW HOLLAND	Schlepper / 4140-8340	6640	0	Sanden	SD7H15	119	8	12	JE	16	12
850886N	NEW HOLLAND	Schlepper / 4140-8340	6640	0	Sanden	SD510	125	6	12	UB	11	15
850887N	NEW HOLLAND	Schlepper / 4140-8340	7740	0	Sanden	SD7H15	119	6	12	GV	16	12
851711N	NEW HOLLAND	Schlepper / 4140-8340	7740	0	Sanden	SD7H15	119	8	12	JE	16	12
850886N	NEW HOLLAND	Schlepper / 4140-8340	7740	0	Sanden	SD510	125	6	12	UB	11	15
850887N	NEW HOLLAND	Schlepper / 4140-8340	7840	0	Sanden	SD7H15	119	6	12	GV	16	12
851711N	NEW HOLLAND	Schlepper / 4140-8340	7840	0	Sanden	SD7H15	119	8	12	JE	16	12



Dasis Nr.	Hersteller	Modell	Typ	KW	Herstellereinschränkung	Kompressor-ID	Riemenscheiben-Ø [mm]	Rippenanzahl	Spannung [V]	Zylinderkopf-ID (Kompressor)	Einlass-Ø [mm]	Auslass-Ø [mm]
850886N	NEW HOLLAND	Schlepper / 4140-8340	7840	0	Sanden	SD510	125	6	12	UB	11	15
850887N	NEW HOLLAND	Schlepper / 4140-8340	8240	0	Sanden	SD7H15	119	6	12	GV	16	12
851711N	NEW HOLLAND	Schlepper / 4140-8340	8240	0	Sanden	SD7H15	119	8	12	JE	16	12
850886N	NEW HOLLAND	Schlepper / 4140-8340	8240	0	Sanden	SD510	125	6	12	UB	11	15
850887N	NEW HOLLAND	Schlepper / 4140-8340	8340	0	Sanden	SD7H15	119	6	12	GV	16	12
851711N	NEW HOLLAND	Schlepper / 4140-8340	8340	0	Sanden	SD7H15	119	8	12	JE	16	12
850886N	NEW HOLLAND	Schlepper / 4140-8340	8340	0	Sanden	SD510	125	6	12	UB	11	15
850888N	NEW HOLLAND	Schlepper / 8160-8560	8160	0								
851785N	NEW HOLLAND	Schlepper / 8160-8560	8160	0	Sanden	SD7H15	120	8	12	JD	12,8	14,5
850888N	NEW HOLLAND	Schlepper / 8160-8560	8260	0								
851785N	NEW HOLLAND	Schlepper / 8160-8560	8260	0	Sanden	SD7H15	120	8	12	JD	12,8	14,5
850888N	NEW HOLLAND	Schlepper / 8160-8560	8360	0								
851785N	NEW HOLLAND	Schlepper / 8160-8560	8360	0	Sanden	SD7H15	120	8	12	JD	12,8	14,5
850888N	NEW HOLLAND	Schlepper / 8160-8560	8560	0								
851785N	NEW HOLLAND	Schlepper / 8160-8560	8560	0	Sanden	SD7H15	120	8	12	JD	12,8	14,5
850889N	NEW HOLLAND	Schlepper / 8670-8970	8670	0	Sanden	SD7H15	133	8	12	KC	13	15
850889N	NEW HOLLAND	Schlepper / 8670-8970	8770	0	Sanden	SD7H15	133	8	12	KC	13	15
850889N	NEW HOLLAND	Schlepper / 8670-8970	8870	0	Sanden	SD7H15	133	8	12	KC	13	15
850889N	NEW HOLLAND	Schlepper / 8670-8970	8970	0	Sanden	SD7H15	133	8	12	KC	13	15
850889N	NEW HOLLAND	Schlepper / 8670A-8970A	8670A	0	Sanden	SD7H15	133	8	12	KC	13	15
850889N	NEW HOLLAND	Schlepper / 8670A-8970A	8770A	0	Sanden	SD7H15	133	8	12	KC	13	15

Dasis Nr.	Hersteller	Modell	Typ	KW	Herstellereinschränkung	Kompressor-ID	Riemenscheiben-Ø [mm]	Rippenanzahl	Spannung [V]	Zylinderkopf-ID (Kompressor)	Einlass-Ø [mm]	Auslass-Ø [mm]
850889N	NEW HOLLAND	Schlepper / 8670A-8970A	8870A	0	Sanden	SD7H15	133	8	12	KC	13	15
850889N	NEW HOLLAND	Schlepper / 8670A-8970A	8970A	0	Sanden	SD7H15	133	8	12	KC	13	15
851105N	NEW HOLLAND	Schlepper / FW	20	0	Sanden	SD508	132	2	12	B	16	13
851728N	NEW HOLLAND	Schlepper / FW	30	0	Sanden	SD510	159	1	12			
851728N	NEW HOLLAND	Schlepper / FW	40	0	Sanden	SD510	159	1	12			
851728N	NEW HOLLAND	Schlepper / FW	60	0	Sanden	SD510	159	1	12			
850889N	NEW HOLLAND	Schlepper / G	170	0	Sanden	SD7H15	133	8	12	KC	13	15
850889N	NEW HOLLAND	Schlepper / G	190	0	Sanden	SD7H15	133	8	12	KC	13	15
851733N	NEW HOLLAND	Schlepper / LB	115	0	Sanden	SD7H15HD	140	2	12	GV	16	16
852996N	NEW HOLLAND	Schlepper / T	7.230	0	Sanden	SD7H15	119	10	12		12	15
852996N	NEW HOLLAND	Schlepper / T	7.245	0	Sanden	SD7H15	119	10	12		12	15
852996N	NEW HOLLAND	Schlepper / T	7.260	0	Sanden	SD7H15	119	10	12		12	15
852996N	NEW HOLLAND	Schlepper / T	7.270	0	Sanden	SD7H15	119	10	12		12	15
852992N	NEW HOLLAND	Schlepper / T5 Serie	T5.95	0	Sanden	SD7H15	112	6	12		13	13
852992N	NEW HOLLAND	Schlepper / T5 Serie	T5.100	0	Sanden	SD7H15	112	6	12		13	13
852992N	NEW HOLLAND	Schlepper / T5 Serie	T5.105	0	Sanden	SD7H15	112	6	12		13	13
852992N	NEW HOLLAND	Schlepper / T5 Serie	T5.110	0	Sanden	SD7H15	112	6	12		13	13
852992N	NEW HOLLAND	Schlepper / T5 Serie	T5.115	0	Sanden	SD7H15	112	6	12		13	13
852992N	NEW HOLLAND	Schlepper / T5 Serie	T5.120	0	Sanden	SD7H15	112	6	12		13	13
851724N	NEW HOLLAND	Schlepper / TDD	TD55D	0								
851724N	NEW HOLLAND	Schlepper / TDD	TD60D	0								
851724N	NEW HOLLAND	Schlepper / TDD	TD70D	0								
851724N	NEW HOLLAND	Schlepper / TDD	TD75D	0								
851724N	NEW HOLLAND	Schlepper / TDD	TD80D	0								
851724N	NEW HOLLAND	Schlepper / TDD	TD85D	0								
851724N	NEW HOLLAND	Schlepper / TDD	TD90D	0								
851724N	NEW HOLLAND	Schlepper / TDD	TD95D	0								
850874N	NEW HOLLAND	Schlepper / TG	210	0	Sanden	SD7H15HD	152	2	12	MD	14,5	14,5

Dasis Nr.	Hersteller	Modell	Typ	KW	Herstellereinschränkung	Kompressor-ID	Riemenscheiben-Ø [mm]	Rippenanzahl	Spannung [V]	Zylinderkopf-ID (Kompressor)	Einlass-Ø [mm]	Auslass-Ø [mm]
850874N	NEW HOLLAND	Schlepper / TG	230	0	Sanden	SD7H15HD	152	2	12	MD	14,5	14,5
850874N	NEW HOLLAND	Schlepper / TG	255	0	Sanden	SD7H15HD	152	2	12	MD	14,5	14,5
850874N	NEW HOLLAND	Schlepper / TG	285	0	Sanden	SD7H15HD	152	2	12	MD	14,5	14,5
850874N	NEW HOLLAND	Schlepper / TJ	275	0	Sanden	SD7H15HD	152	2	12	MD	14,5	14,5
850874N	NEW HOLLAND	Schlepper / TJ	325	0	Sanden	SD7H15HD	152	2	12	MD	14,5	14,5
850874N	NEW HOLLAND	Schlepper / TJ	330	0	Sanden	SD7H15HD	152	2	12	MD	14,5	14,5
851722N	NEW HOLLAND	Schlepper / TJ	355	0	Sanden	SD7H15HD	152	8	12	MD		
851722N	NEW HOLLAND	Schlepper / TJ	380	0	Sanden	SD7H15HD	152	8	12	MD		
851722N	NEW HOLLAND	Schlepper / TJ	425	0	Sanden	SD7H15HD	152	8	12	MD		
851722N	NEW HOLLAND	Schlepper / TJ	430	0	Sanden	SD7H15HD	152	8	12	MD		
850874N	NEW HOLLAND	Schlepper / TJ	480	0	Sanden	SD7H15HD	152	2	12	MD	14,5	14,5
851722N	NEW HOLLAND	Schlepper / TJ	480	0	Sanden	SD7H15HD	152	8	12	MD		
851722N	NEW HOLLAND	Schlepper / TJ	500	0	Sanden	SD7H15HD	152	8	12	MD		
850874N	NEW HOLLAND	Schlepper / TJ	550	0	Sanden	SD7H15HD	152	2	12	MD	14,5	14,5
851722N	NEW HOLLAND	Schlepper / TJ	550	0	Sanden	SD7H15HD	152	8	12	MD		
851724N	NEW HOLLAND	Schlepper / TL	70	0								
851724N	NEW HOLLAND	Schlepper / TL	80	0								
851724N	NEW HOLLAND	Schlepper / TL	90	0								
851724N	NEW HOLLAND	Schlepper / TL	100	0								
852159N	NEW HOLLAND	Schlepper / TLA	70A	0	Sanden	SD7H15	125	2	12	OB	14,5	14,5
852159N	NEW HOLLAND	Schlepper / TLA	80A	0	Sanden	SD7H15	125	2	12	OB	14,5	14,5
852159N	NEW HOLLAND	Schlepper / TLA	90A	0	Sanden	SD7H15	125	2	12	OB	14,5	14,5
852159N	NEW HOLLAND	Schlepper / TLA	100A	0	Sanden	SD7H15	125	2	12	OB	14,5	14,5
850888N	NEW HOLLAND	Schlepper / TM	TM115	0								
851785N	NEW HOLLAND	Schlepper / TM	TM115	0	Sanden	SD7H15	120	8	12	JD	12,8	14,5
850888N	NEW HOLLAND	Schlepper / TM	TM120	0								
851785N	NEW HOLLAND	Schlepper / TM	TM120	0	Sanden	SD7H15	120	8	12	JD	12,8	14,5
850888N	NEW HOLLAND	Schlepper / TM	TM125	0								
851785N	NEW HOLLAND	Schlepper / TM	TM125	0	Sanden	SD7H15	120	8	12	JD	12,8	14,5
850888N	NEW HOLLAND	Schlepper / TM	TM130	0								
851785N	NEW HOLLAND	Schlepper / TM	TM130	0	Sanden	SD7H15	120	8	12	JD	12,8	14,5

Dasis Nr.	Hersteller	Modell	Typ	KW	Herstellereinschränkung	Kompressor-ID	Riemenscheiben-Ø [mm]	Rippenanzahl	Spannung [V]	Zylinderkopf-ID (Kompressor)	Einlass-Ø [mm]	Auslass-Ø [mm]
850888N	NEW HOLLAND	Schlepper / TM	TM135	0								
851785N	NEW HOLLAND	Schlepper / TM	TM135	0	Sanden	SD7H15	120	8	12	JD	12,8	14,5
850888N	NEW HOLLAND	Schlepper / TM	TM140	0								
851785N	NEW HOLLAND	Schlepper / TM	TM140	0	Sanden	SD7H15	120	8	12	JD	12,8	14,5
850888N	NEW HOLLAND	Schlepper / TM	TM150	0								
851785N	NEW HOLLAND	Schlepper / TM	TM150	0	Sanden	SD7H15	120	8	12	JD	12,8	14,5
850888N	NEW HOLLAND	Schlepper / TM	TM155	0								
851785N	NEW HOLLAND	Schlepper / TM	TM155	0	Sanden	SD7H15	120	8	12	JD	12,8	14,5
850888N	NEW HOLLAND	Schlepper / TM	TM165	0								
851785N	NEW HOLLAND	Schlepper / TM	TM165	0	Sanden	SD7H15	120	8	12	JD	12,8	14,5
850888N	NEW HOLLAND	Schlepper / TM	TM175	0								
851785N	NEW HOLLAND	Schlepper / TM	TM175	0	Sanden	SD7H15	120	8	12	JD	12,8	14,5
850888N	NEW HOLLAND	Schlepper / TM	TM190	0								
851785N	NEW HOLLAND	Schlepper / TM	TM190	0	Sanden	SD7H15	120	8	12	JD	12,8	14,5
850873N	NEW HOLLAND	Schlepper / TR	76	0	Sanden	SD510HD	132	2	12	M	13,5	13,5
850422N	NEW HOLLAND	Schlepper / TR	76	0	York	R209/210R	ohne Riemenscheibe	ohne Riemenscheibe			13,5	13,5
850873N	NEW HOLLAND	Schlepper / TR	85	0	Sanden	SD510HD	132	2	12	M	13,5	13,5
850422N	NEW HOLLAND	Schlepper / TR	85	0	York	R209/210R	ohne Riemenscheibe	ohne Riemenscheibe			13,5	13,5
850873N	NEW HOLLAND	Schlepper / TR	86	0	Sanden	SD510HD	132	2	12	M	13,5	13,5
850422N	NEW HOLLAND	Schlepper / TR	86	0	York	R209/210R	ohne Riemenscheibe	ohne Riemenscheibe			13,5	13,5
851702N	NEW HOLLAND	Schlepper / TR	87	0		SD5H14	132	2	12			
851702N	NEW HOLLAND	Schlepper / TR	89	0		SD5H14	132	2	12			
858454N	NEW HOLLAND	Schlepper / TR	96	0	Sanden	SD510	132	2	12	M	14	13
850873N	NEW HOLLAND	Schlepper / TR	96	0	Sanden	SD510HD	132	2	12	M	13,5	13,5
850352N	NEW HOLLAND	Schlepper / TR	96	0	York	T209/210L					14,9	14,9
851702N	NEW HOLLAND	Schlepper / TR	97	0		SD5H14	132	2	12			
850873N	NEW HOLLAND	Schlepper / TR	98	0	Sanden	SD510HD	132	2	12	M	13,5	13,5
850422N	NEW HOLLAND	Schlepper / TR	98	0	York	R209/210R	ohne Riemenscheibe	ohne Riemenscheibe			13,5	13,5
851702N	NEW HOLLAND	Schlepper / TR	99	0		SD5H14	132	2	12			
850889N	NEW HOLLAND	Schlepper / TS	80	0	Sanden	SD7H15	133	8	12	KC	13	15

Dasis Nr.	Hersteller	Modell	Typ	KW	Herstellereinschränkung	Kompressor-ID	Riemenscheiben-Ø [mm]	Rippenanzahl	Spannung [V]	Zylinderkopf-ID (Kompressor)	Einlass-Ø [mm]	Auslass-Ø [mm]
850889N	NEW HOLLAND	Schlepper / TS	90	0	Sanden	SD7H15	133	8	12	KC	13	15
850889N	NEW HOLLAND	Schlepper / TS	100	0	Sanden	SD7H15	133	8	12	KC	13	15
850889N	NEW HOLLAND	Schlepper / TS	110	0	Sanden	SD7H15	133	8	12	KC	13	15
850889N	NEW HOLLAND	Schlepper / TS	115	0	Sanden	SD7H15	133	8	12	KC	13	15
851786N	NEW HOLLAND	Schlepper / TSA	100A	0	Sanden	SD7H15	112	4	12	WV	17,7	14,5
851786N	NEW HOLLAND	Schlepper / TSA	110A	0	Sanden	SD7H15	112	4	12	WV	17,7	14,5
851786N	NEW HOLLAND	Schlepper / TSA	115A	0	Sanden	SD7H15	112	4	12	WV	17,7	14,5
851786N	NEW HOLLAND	Schlepper / TSA	125A	0	Sanden	SD7H15	112	4	12	WV	17,7	14,5
851786N	NEW HOLLAND	Schlepper / TSA	135A	0	Sanden	SD7H15	112	4	12	WV	17,7	14,5
850888N	NEW HOLLAND	Schlepper / TV	140	0								
851785N	NEW HOLLAND	Schlepper / TV	140	0	Sanden	SD7H15	120	8	12	JD	12,8	14,5
851785N	NEW HOLLAND	Schlepper / TV	145	0	Sanden	SD7H15	120	8	12	JD	12,8	14,5
850874N	NEW HOLLAND	Schlepper / TVT	170	0	Sanden	SD7H15HD	152	2	12	MD	14,5	14,5
850879N	NEW HOLLAND	Schlepper / TW	10	0	Sanden	SD5H14	132	2	12	K	16	12
850879N	NEW HOLLAND	Schlepper / TW	20	0	Sanden	SD5H14	132	2	12	K	16	12
850879N	NEW HOLLAND	Schlepper / TW	30	0	Sanden	SD5H14	132	2	12	K	16	12
850879N	NEW HOLLAND	Schlepper / TW5	5	0	Sanden	SD5H14	132	2	12	K	16	12
850879N	NEW HOLLAND	Schlepper / TW5	15	0	Sanden	SD5H14	132	2	12	K	16	12
850879N	NEW HOLLAND	Schlepper / TW5	25	0	Sanden	SD5H14	132	2	12	K	16	12
850879N	NEW HOLLAND	Schlepper / TW5	35	0	Sanden	SD5H14	132	2	12	K	16	12
850414N	NEW HOLLAND	Schlepper Wein Obst / TN	55	0	Sanden	SD5H14	132	2	12	M	13	11
850414N	NEW HOLLAND	Schlepper Wein Obst / TN	65	0	Sanden	SD5H14	132	2	12	M	13	11
850414N	NEW HOLLAND	Schlepper Wein Obst / TN	70	0	Sanden	SD5H14	132	2	12	M	13	11
850414N	NEW HOLLAND	Schlepper Wein Obst / TN	75	0	Sanden	SD5H14	132	2	12	M	13	11
850414N	NEW HOLLAND	Schlepper Wein Obst / TND	55	0	Sanden	SD5H14	132	2	12	M	13	11
850414N	NEW HOLLAND	Schlepper Wein Obst / TND	65	0	Sanden	SD5H14	132	2	12	M	13	11
850414N	NEW HOLLAND	Schlepper Wein Obst / TND	70	0	Sanden	SD5H14	132	2	12	M	13	11
850414N	NEW HOLLAND	Schlepper Wein Obst / TND	75	0	Sanden	SD5H14	132	2	12	M	13	11

Dasis Nr.	Hersteller	Modell	Typ	KW	Herstellereinschränkung	Kompressor-ID	Riemenscheiben-Ø [mm]	Rippenanzahl	Spannung [V]	Zylinderkopf-ID (Kompressor)	Einlass-Ø [mm]	Auslass-Ø [mm]
850414N	NEW HOLLAND	Schlepper Wein Obst / TNF	65	0	Sanden	SD5H14	132	2	12	M	13	11
850414N	NEW HOLLAND	Schlepper Wein Obst / TNF	70	0	Sanden	SD5H14	132	2	12	M	13	11
850414N	NEW HOLLAND	Schlepper Wein Obst / TNF	75	0	Sanden	SD5H14	132	2	12	M	13	11
850414N	NEW HOLLAND	Schlepper Wein Obst / TNF	80	0	Sanden	SD5H14	132	2	12	M	13	11
850414N	NEW HOLLAND	Schlepper Wein Obst / TNF	90	0	Sanden	SD5H14	132	2	12	M	13	11
850414N	NEW HOLLAND	Schlepper Wein Obst / TNF	95	0	Sanden	SD5H14	132	2	12	M	13	11
850414N	NEW HOLLAND	Schlepper Wein Obst / TNS	55	0	Sanden	SD5H14	132	2	12	M	13	11
850414N	NEW HOLLAND	Schlepper Wein Obst / TNS	65	0	Sanden	SD5H14	132	2	12	M	13	11
850414N	NEW HOLLAND	Schlepper Wein Obst / TNS	70	0	Sanden	SD5H14	132	2	12	M	13	11
850414N	NEW HOLLAND	Schlepper Wein Obst / TNS	75	0	Sanden	SD5H14	132	2	12	M	13	11
850879N	NEW HOLLAND	Schlepper Wein Obst / TW	5	0	Sanden	SD5H14	132	2	12	K	16	12
850876N	NEW HOLLAND	Schlepper Wein Obst / TW	15	0	Sanden	SD5H14	152	2	12		16	14
850879N	NEW HOLLAND	Schlepper Wein Obst / TW	25	0	Sanden	SD5H14	132	2	12	K	16	12
850879N	NEW HOLLAND	Schlepper Wein Obst / TW	30	0	Sanden	SD5H14	132	2	12	K	16	12
850879N	NEW HOLLAND	Schlepper Wein Obst / TW	35	0	Sanden	SD5H14	132	2	12	K	16	12
851741N	NEW HOLLAND	Teleskopklader / LMA	410	0	Sanden	SD7H15	135	1	12		14	14
851741N	NEW HOLLAND	Teleskopklader / LMA	415	0	Sanden	SD7H15	135	1	12		14	14
851741N	NEW HOLLAND	Teleskopklader / LMA	420	0	Sanden	SD7H15	135	1	12		14	14
851741N	NEW HOLLAND	Teleskopklader / LMA	425A	0	Sanden	SD7H15	135	1	12		14	14
852874N	Perkins	Serie 700	704-30 D/T	0	Seltec / Zexel	TM08	135	2	12		14	16
850340N	Renault	Schlepper / Ares 500	531S	0	Denso	10PA15C	125	8	12			
850340N	Renault	Schlepper / Ares 500	540	0	Denso	10PA15C	125	8	12			

Dasis Nr.	Hersteller	Modell	Typ	KW	Herstellereinschränkung	Kompressor-ID	Riemenscheiben-Ø [mm]	Rippenanzahl	Spannung [V]	Zylinderkopf-ID (Kompressor)	Einlass-Ø [mm]	Auslass-Ø [mm]
850340N	Renault	Schlepper / Ares 500	546	0	Denso	10PA15C	125	8	12			
850340N	Renault	Schlepper / Ares 500	550	0	Denso	10PA15C	125	8	12			
850340N	Renault	Schlepper / Ares 500	556	0	Denso	10PA15C	125	8	12			
850340N	Renault	Schlepper / Ares 500	560	0	Denso	10PA15C	125	8	12			
850340N	Renault	Schlepper / Ares 500	566	0	Denso	10PA15C	125	8	12			
850340N	Renault	Schlepper / Ares 600	610	0	Denso	10PA15C	125	8	12			
850340N	Renault	Schlepper / Ares 600	616	0	Denso	10PA15C	125	8	12			
850340N	Renault	Schlepper / Ares 600	620	0	Denso	10PA15C	125	8	12			
850340N	Renault	Schlepper / Ares 600	626	0	Denso	10PA15C	125	8	12			
850340N	Renault	Schlepper / Ares 600	630	0	Denso	10PA15C	125	8	12			
850340N	Renault	Schlepper / Ares 600	636	0	Denso	10PA15C	125	8	12			
850340N	Renault	Schlepper / Ares 600	640	0	Denso	10PA15C	125	8	12			
850340N	Renault	Schlepper / Ares 600	696	0	Denso	10PA15C	125	8	12			
850340N	Renault	Schlepper / Ares 700	710	0	Denso	10PA15C	125	8	12			
850340N	Renault	Schlepper / Ares 700	715	0	Denso	10PA15C	125	8	12			
850340N	Renault	Schlepper / Ares 700	720	0	Denso	10PA15C	125	8	12			
850340N	Renault	Schlepper / Ares 700	725	0	Denso	10PA15C	125	8	12			
850340N	Renault	Schlepper / Ares 700	735	0	Denso	10PA15C	125	8	12			
850340N	Renault	Schlepper / Ares 800	815	0	Denso	10PA15C	125	8	12			
850340N	Renault	Schlepper / Ares 800	816	0	Denso	10PA15C	125	8	12			
850340N	Renault	Schlepper / Ares 800	825	0	Denso	10PA15C	125	8	12			

Dasis Nr.	Hersteller	Modell	Typ	KW	Herstellereinschränkung	Kompressor-ID	Riemenscheiben-Ø [mm]	Rippenanzahl	Spannung [V]	Zylinderkopf-ID (Kompressor)	Einlass-Ø [mm]	Auslass-Ø [mm]
850340N	Renault	Schlepper / Ares 800	826	0	Denso	10PA15C	125	8	12			
850340N	Renault	Schlepper / Ares 800	836	0	Denso	10PA15C	125	8	12			
851739N	Renault	Schlepper / Atlas	915	0	Denso	10PA15C	125	8	12			
851739N	Renault	Schlepper / Atlas	925	0	Denso	10PA15C	125	8	12			
851739N	Renault	Schlepper / Atlas	926	0	Denso	10PA15C	125	8	12			
851739N	Renault	Schlepper / Atlas	935	0	Denso	10PA15C	125	8	12			
851739N	Renault	Schlepper / Atlas	936	0	Denso	10PA15C	125	8	12			
850859N	Renault	Schlepper / Ceres	310	0								
850340N	Renault	Schlepper / Ceres	310	0	Denso	10PA15C	125	8	12			
850859N	Renault	Schlepper / Ceres	320	0								
850340N	Renault	Schlepper / Ceres	320	0	Denso	10PA15C	125	8	12			
850859N	Renault	Schlepper / Ceres	325	0								
850340N	Renault	Schlepper / Ceres	325	0	Denso	10PA15C	125	8	12			
850859N	Renault	Schlepper / Ceres	330	0								
850340N	Renault	Schlepper / Ceres	330	0	Denso	10PA15C	125	8	12			
850859N	Renault	Schlepper / Ceres	335	0								
850340N	Renault	Schlepper / Ceres	335	0	Denso	10PA15C	125	8	12			
850859N	Renault	Schlepper / Ceres	340	0								
850340N	Renault	Schlepper / Ceres	340	0	Denso	10PA15C	125	8	12			
850859N	Renault	Schlepper / Ceres	345	0								
850340N	Renault	Schlepper / Ceres	345	0	Denso	10PA15C	125	8	12			
850859N	Renault	Schlepper / Ceres	355	0								
850340N	Renault	Schlepper / Ceres	355	0	Denso	10PA15C	125	8	12			



Dasis Nr.	Hersteller	Modell	Typ	KW	Herstellereinschränkung	Kompressor-ID	Riemenscheiben-Ø [mm]	Rippenanzahl	Spannung [V]	Zylinderkopf-ID (Kompressor)	Einlass-Ø [mm]	Auslass-Ø [mm]
850859N	Renault	Schlepper / Cergos	330	0								
850340N	Renault	Schlepper / Cergos	330	0	Denso	10PA15C	125	8	12			
850859N	Renault	Schlepper / Cergos	335	0								
850340N	Renault	Schlepper / Cergos	335	0	Denso	10PA15C	125	8	12			
850859N	Renault	Schlepper / Cergos	340	0								
850340N	Renault	Schlepper / Cergos	340	0	Denso	10PA15C	125	8	12			
850859N	Renault	Schlepper / Cergos	345	0								
850340N	Renault	Schlepper / Cergos	345	0	Denso	10PA15C	125	8	12			
850859N	Renault	Schlepper / Cergos	350	0								
850340N	Renault	Schlepper / Cergos	350	0	Denso	10PA15C	125	8	12			
850859N	Renault	Schlepper / Cergos	355	0								
850340N	Renault	Schlepper / Cergos	355	0	Denso	10PA15C	125	8	12			
850859N	Renault	Schlepper / Ergos	85	0								
850859N	Renault	Schlepper / Ergos	85-4	0								
850859N	Renault	Schlepper / Ergos	90	0								
850859N	Renault	Schlepper / Ergos	90-4	0								
850859N	Renault	Schlepper / Ergos	95	0								
850859N	Renault	Schlepper / Ergos	95-4	0								
850859N	Renault	Schlepper / Ergos	95-4PJV	0								
850895N	Renault	Schlepper / Ergos	100	0	Sanden	SD6V12	125	6	12		20,6	14,3
850895N	Renault	Schlepper / Ergos	100-4	0	Sanden	SD6V12	125	6	12		20,6	14,3
851745N	Renault	Schlepper / Ergos	100-4P	0	Denso	10PA15C	133	1	12		10,5	14,5
850859N	Renault	Schlepper / Ergos	100-4PJVHyro	0								
851745N	Renault	Schlepper / Ergos	100P	0	Denso	10PA15C	133	1	12		10,5	14,5
851745N	Renault	Schlepper / Ergos	100PJVHyro	0	Denso	10PA15C	133	1	12		10,5	14,5
850859N	Renault	Schlepper / Ergos	105	0								

Dasis Nr.	Hersteller	Modell	Typ	KW	Herstellereinschränkung	Kompressor-ID	Riemenscheiben-Ø [mm]	Rippenanzahl	Spannung [V]	Zylinderkopf-ID (Kompressor)	Einlass-Ø [mm]	Auslass-Ø [mm]
850859N	Renault	Schlepper / Ergos	105-4	0								
851745N	Renault	Schlepper / Ergos	105-4P	0	Denso	10PA15C	133	1	12		10,5	14,5
850895N	Renault	Schlepper / Ergos	105-4PJV	0	Sanden	SD6V12	125	6	12		20,6	14,3
850895N	Renault	Schlepper / Ergos	105PJV	0	Sanden	SD6V12	125	6	12		20,6	14,3
850859N	Renault	Schlepper / Ergos	110	0								
850859N	Renault	Schlepper / Ergos	110-4	0								
851745N	Renault	Schlepper / Ergos	110-4P	0	Denso	10PA15C	133	1	12		10,5	14,5
850859N	Renault	Schlepper / Ergos	110-4PJV	0								
851745N	Renault	Schlepper / Ergos	110P	0	Denso	10PA15C	133	1	12		10,5	14,5
850859N	Renault	Schlepper / Ergos	110PJV	0								
850859N	Renault	Schlepper / Ergos	436	0								
850891N	Renault	Schlepper / Ergos	436	0	Sanden	SD7H15	158	2	12			
850859N	Renault	Schlepper / Ergos	436-4	0								
850891N	Renault	Schlepper / Ergos	436-4	0	Sanden	SD7H15	158	2	12			
850859N	Renault	Schlepper / Ergos	446	0								
850891N	Renault	Schlepper / Ergos	446	0	Sanden	SD7H15	158	2	12			
850859N	Renault	Schlepper / Ergos	446-4	0								
851745N	Renault	Schlepper / Ergos	446-4P	0	Denso	10PA15C	133	1	12		10,5	14,5
850859N	Renault	Schlepper / Ergos	446-4PJV	0								
850891N	Renault	Schlepper / Ergos	446P	0	Sanden	SD7H15	158	2	12			
850859N	Renault	Schlepper / Ergos	446PJV	0								
850859N	Renault	Schlepper / Ergos	456	0								
850859N	Renault	Schlepper / Ergos	456-4	0								
851745N	Renault	Schlepper / Ergos	456-4P	0	Denso	10PA15C	133	1	12		10,5	14,5
850859N	Renault	Schlepper / Ergos	456-4PJV	0								
851745N	Renault	Schlepper / Ergos	456P	0	Denso	10PA15C	133	1	12		10,5	14,5
850859N	Renault	Schlepper / Ergos	456PJV	0								
850859N	Renault	Schlepper / Ergos	466	0								
850859N	Renault	Schlepper / Ergos	466-4	0								
851745N	Renault	Schlepper / Ergos	466-4P	0	Denso	10PA15C	133	1	12		10,5	14,5
850859N	Renault	Schlepper / Ergos	466-4PJV	0								

Dasis Nr.	Hersteller	Modell	Typ	KW	Herstellereinschränkung	Kompressor-ID	Riemenscheiben-Ø [mm]	Rippenanzahl	Spannung [V]	Zylinderkopf-ID (Kompressor)	Einlass-Ø [mm]	Auslass-Ø [mm]
851745N	Renault	Schlepper / Ergos	466P	0	Denso	10PA15C	133	1	12		10,5	14,5
850859N	Renault	Schlepper / Ergos	466PJV	0								
850891N	Renault	Schlepper / M	110-14	0	Sanden	SD7H15	158	2	12			
850891N	Renault	Schlepper / M	120-14	0	Sanden	SD7H15	158	2	12			
850891N	Renault	Schlepper / M	133-14	0	Sanden	SD7H15	158	2	12			
850891N	Renault	Schlepper / M	145-14	0	Sanden	SD7H15	158	2	12			
850891N	Renault	Schlepper / M	421	0	Sanden	SD7H15	158	2	12			
850891N	Renault	Schlepper / M	600	0	Sanden	SD7H15	158	2	12			
850891N	Renault	Schlepper / M	650	0	Sanden	SD7H15	158	2	12			
850891N	Renault	Schlepper / M	700	0	Sanden	SD7H15	158	2	12			
850891N	Renault	Schlepper / M	704	0	Sanden	SD7H15	158	2	12			
850891N	Renault	Schlepper / M	720	0	Sanden	SD7H15	158	2	12			
850891N	Renault	Schlepper / M	724	0	Sanden	SD7H15	158	2	12			
850891N	Renault	Schlepper / M	750	0	Sanden	SD7H15	158	2	12			
850891N	Renault	Schlepper / M	751	0	Sanden	SD7H15	158	2	12			
850891N	Renault	Schlepper / M	754	0	Sanden	SD7H15	158	2	12			
850891N	Renault	Schlepper / M	800	0	Sanden	SD7H15	158	2	12			
850891N	Renault	Schlepper / M	804	0	Sanden	SD7H15	158	2	12			
850891N	Renault	Schlepper / M	850	0	Sanden	SD7H15	158	2	12			
850891N	Renault	Schlepper / M	854	0	Sanden	SD7H15	158	2	12			
850891N	Renault	Schlepper / M	900	0	Sanden	SD7H15	158	2	12			
850891N	Renault	Schlepper / M	940	0	Sanden	SD7H15	158	2	12			
850891N	Renault	Schlepper / M	950	0	Sanden	SD7H15	158	2	12			
850891N	Renault	Schlepper / M	954	0	Sanden	SD7H15	158	2	12			
850891N	Renault	Schlepper / ME	58-32ME	0	Sanden	SD7H15	158	2	12			
850891N	Renault	Schlepper / ME	58-34ME	0	Sanden	SD7H15	158	2	12			
850891N	Renault	Schlepper / ME	65-32ME	0	Sanden	SD7H15	158	2	12			
850891N	Renault	Schlepper / ME	65-34ME	0	Sanden	SD7H15	158	2	12			
850891N	Renault	Schlepper / ME	75-12ME	0	Sanden	SD7H15	158	2	12			
850891N	Renault	Schlepper / ME	75-32ME	0	Sanden	SD7H15	158	2	12			
850891N	Renault	Schlepper / ME	75-34ME	0	Sanden	SD7H15	158	2	12			

Dasis Nr.	Hersteller	Modell	Typ	KW	Herstellereinschränkung	Kompressor-ID	Riemenscheiben-Ø [mm]	Rippenanzahl	Spannung [V]	Zylinderkopf-ID (Kompressor)	Einlass-Ø [mm]	Auslass-Ø [mm]
850891N	Renault	Schlepper / ME	85-32ME	0	Sanden	SD7H15	158	2	12			
850891N	Renault	Schlepper / ME	85-34ME	0	Sanden	SD7H15	158	2	12			
850891N	Renault	Schlepper / ME	90-32ME	0	Sanden	SD7H15	158	2	12			
850891N	Renault	Schlepper / ME	90-34ME	0	Sanden	SD7H15	158	2	12			
850891N	Renault	Schlepper / ME	110-14ME	0	Sanden	SD7H15	158	2	12			
850891N	Renault	Schlepper / ME	120-14ME	0	Sanden	SD7H15	158	2	12			
850891N	Renault	Schlepper / ME	133-14ME	0	Sanden	SD7H15	158	2	12			
850891N	Renault	Schlepper / ME	145-14ME	0	Sanden	SD7H15	158	2	12			
850891N	Renault	Schlepper / MI	650	0	Sanden	SD7H15	158	2	12			
850891N	Renault	Schlepper / MI	750	0	Sanden	SD7H15	158	2	12			
850891N	Renault	Schlepper / MI	754	0	Sanden	SD7H15	158	2	12			
850891N	Renault	Schlepper / MI	850	0	Sanden	SD7H15	158	2	12			
850891N	Renault	Schlepper / MI	850PJV	0	Sanden	SD7H15	158	2	12			
850891N	Renault	Schlepper / MI	854	0	Sanden	SD7H15	158	2	12			
850891N	Renault	Schlepper / MI	854PJV	0	Sanden	SD7H15	158	2	12			
850891N	Renault	Schlepper / MI	900PJV	0	Sanden	SD7H15	158	2	12			
850891N	Renault	Schlepper / MI	904PJV	0	Sanden	SD7H15	158	2	12			
850891N	Renault	Schlepper / MI	950	0	Sanden	SD7H15	158	2	12			
850891N	Renault	Schlepper / MI	954	0	Sanden	SD7H15	158	2	12			
850891N	Renault	Schlepper / R	95-12	0	Sanden	SD7H15	158	2	12			
850891N	Renault	Schlepper / R	95-14	0	Sanden	SD7H15	158	2	12			
850891N	Renault	Schlepper / R	103-12	0	Sanden	SD7H15	158	2	12			
850891N	Renault	Schlepper / R	103-14	0	Sanden	SD7H15	158	2	12			
850891N	Renault	Schlepper / R	113-12	0	Sanden	SD7H15	158	2	12			
850891N	Renault	Schlepper / R	113-14	0	Sanden	SD7H15	158	2	12			
850891N	Renault	Schlepper / RE	95-12RE	0	Sanden	SD7H15	158	2	12			
850891N	Renault	Schlepper / RE	95-14RE	0	Sanden	SD7H15	158	2	12			
850891N	Renault	Schlepper / RE	103-12RE	0	Sanden	SD7H15	158	2	12			
850891N	Renault	Schlepper / RE	103-14RE	0	Sanden	SD7H15	158	2	12			
850891N	Renault	Schlepper / RE	110-14RE	0	Sanden	SD7H15	158	2	12			
850891N	Renault	Schlepper / RE	113-12RE	0	Sanden	SD7H15	158	2	12			

Dasis Nr.	Hersteller	Modell	Typ	KW	Herstellereinschränkung	Kompressor-ID	Riemenscheiben-Ø [mm]	Rippenanzahl	Spannung [V]	Zylinderkopf-ID (Kompressor)	Einlass-Ø [mm]	Auslass-Ø [mm]
850891N	Renault	Schlepper / RE	113-14RE	0	Sanden	SD7H15	158	2	12			
850891N	Renault	Schlepper / RE	120-14RE	0	Sanden	SD7H15	158	2	12			
850891N	Renault	Schlepper / RE	133-14RE	0	Sanden	SD7H15	158	2	12			
850891N	Renault	Schlepper / RE	145-14RE	0	Sanden	SD7H15	158	2	12			
850891N	Renault	Schlepper / RS	61-12	0	Sanden	SD7H15	158	2	12			
850891N	Renault	Schlepper / RS	61-14	0	Sanden	SD7H15	158	2	12			
850891N	Renault	Schlepper / RS	68-12	0	Sanden	SD7H15	158	2	12			
850891N	Renault	Schlepper / RS	68-14	0	Sanden	SD7H15	158	2	12			
850891N	Renault	Schlepper / RS	75-12	0	Sanden	SD7H15	158	2	12			
850891N	Renault	Schlepper / RS	75-14	0	Sanden	SD7H15	158	2	12			
850891N	Renault	Schlepper / RS	95-12	0	Sanden	SD7H15	158	2	12			
850891N	Renault	Schlepper / RS	95-14	0	Sanden	SD7H15	158	2	12			
850891N	Renault	Schlepper / RS	103-12	0	Sanden	SD7H15	158	2	12			
850891N	Renault	Schlepper / RS	103-14	0	Sanden	SD7H15	158	2	12			
850340N	Renault	Schlepper / RX	531S	0	Denso	10PA15C	125	8	12			
850340N	Renault	Schlepper / RX	540	0	Denso	10PA15C	125	8	12			
850340N	Renault	Schlepper / RX	550	0	Denso	10PA15C	125	8	12			
850340N	Renault	Schlepper / RX	610	0	Denso	10PA15C	125	8	12			
850340N	Renault	Schlepper / RX	620	0	Denso	10PA15C	125	8	12			
850340N	Renault	Schlepper / RX	630	0	Denso	10PA15C	125	8	12			
850340N	Renault	Schlepper / RZ	610	0	Denso	10PA15C	125	8	12			
850340N	Renault	Schlepper / RZ	620	0	Denso	10PA15C	125	8	12			
850340N	Renault	Schlepper / RZ	630	0	Denso	10PA15C	125	8	12			
850340N	Renault	Schlepper / RZ	640	0	Denso	10PA15C	125	8	12			
850340N	Renault	Schlepper / RZ	710	0	Denso	10PA15C	125	8	12			
850340N	Renault	Schlepper / RZ	720	0	Denso	10PA15C	125	8	12			
850340N	Renault	Schlepper / RZ	725	0	Denso	10PA15C	125	8	12			
850340N	Renault	Schlepper / RZ	735	0	Denso	10PA15C	125	8	12			
850340N	Renault	Schlepper / RZ	815	0	Denso	10PA15C	125	8	12			
850340N	Renault	Schlepper / RZ	825	0	Denso	10PA15C	125	8	12			
850891N	Renault	Schlepper / S	106-14	0	Sanden	SD7H15	158	2	12			

Dasis Nr.	Hersteller	Modell	Typ	KW	Herstellereinschränkung	Kompressor-ID	Riemenscheiben-Ø [mm]	Rippenanzahl	Spannung [V]	Zylinderkopf-ID (Kompressor)	Einlass-Ø [mm]	Auslass-Ø [mm]
850891N	Renault	Schlepper / T	103-52	0	Sanden	SD7H15	158	2	12			
850891N	Renault	Schlepper / T	103-54	0	Sanden	SD7H15	158	2	12			
850891N	Renault	Schlepper / T	106-54	0	Sanden	SD7H15	158	2	12			
850891N	Renault	Schlepper / T	110-54	0	Sanden	SD7H15	158	2	12			
850891N	Renault	Schlepper / T	120-54	0	Sanden	SD7H15	158	2	12			
850891N	Renault	Schlepper / T	133-54	0	Sanden	SD7H15	158	2	12			
850891N	Renault	Schlepper / T	145-54	0	Sanden	SD7H15	158	2	12			
850891N	Renault	Schlepper / T	155-54	0	Sanden	SD7H15	158	2	12			
850891N	Renault	Schlepper / T	160-94	0	Sanden	SD7H15	158	2	12			
850891N	Renault	Schlepper / T	175-74	0	Sanden	SD7H15	158	2	12			
850891N	Renault	Schlepper / T	180-94	0	Sanden	SD7H15	158	2	12			
850891N	Renault	Schlepper / TA	103-52	0	Sanden	SD7H15	158	2	12			
850891N	Renault	Schlepper / TA	103-54	0	Sanden	SD7H15	158	2	12			
850891N	Renault	Schlepper / TA	110-14	0	Sanden	SD7H15	158	2	12			
850891N	Renault	Schlepper / TA	110-54	0	Sanden	SD7H15	158	2	12			
850891N	Renault	Schlepper / TA	120-14	0	Sanden	SD7H15	158	2	12			
850891N	Renault	Schlepper / TA	120-54	0	Sanden	SD7H15	158	2	12			
850891N	Renault	Schlepper / TA	133-14	0	Sanden	SD7H15	158	2	12			
850891N	Renault	Schlepper / TA	133-54	0	Sanden	SD7H15	158	2	12			
850891N	Renault	Schlepper / TA	145-14	0	Sanden	SD7H15	158	2	12			
850891N	Renault	Schlepper / TA	145-54	0	Sanden	SD7H15	158	2	12			
850891N	Renault	Schlepper / TA	155-54	0	Sanden	SD7H15	158	2	12			
850891N	Renault	Schlepper / TE	103-52TE	0	Sanden	SD7H15	158	2	12			
850891N	Renault	Schlepper / TE	103-54TE	0	Sanden	SD7H15	158	2	12			
850891N	Renault	Schlepper / TE	110-14TE	0	Sanden	SD7H15	158	2	12			
850891N	Renault	Schlepper / TE	110-54TE	0	Sanden	SD7H15	158	2	12			
850891N	Renault	Schlepper / TE	120-14TE	0	Sanden	SD7H15	158	2	12			
850891N	Renault	Schlepper / TE	120-54TE	0	Sanden	SD7H15	158	2	12			
850891N	Renault	Schlepper / TE	133-14TE	0	Sanden	SD7H15	158	2	12			
850891N	Renault	Schlepper / TE	133-54TE	0	Sanden	SD7H15	158	2	12			
850891N	Renault	Schlepper / TE	145-14TE	0	Sanden	SD7H15	158	2	12			

Dasis Nr.	Hersteller	Modell	Typ	KW	Herstellereinschränkung	Kompressor-ID	Riemenscheiben-Ø [mm]	Rippenanzahl	Spannung [V]	Zylinderkopf-ID (Kompressor)	Einlass-Ø [mm]	Auslass-Ø [mm]
850891N	Renault	Schlepper / TE	145-54TE	0	Sanden	SD7H15	158	2	12			
850891N	Renault	Schlepper / TE	155-54TE	0	Sanden	SD7H15	158	2	12			
851104N	Renault	Schlepper / Temis	550	0	Denso	10PA15C	133	1	12			
851104N	Renault	Schlepper / Temis	610	0	Denso	10PA15C	133	1	12			
851104N	Renault	Schlepper / Temis	630	0	Denso	10PA15C	133	1	12			
851104N	Renault	Schlepper / Temis	650	0	Denso	10PA15C	133	1	12			
850891N	Renault	Schlepper / TL	106-54	0	Sanden	SD7H15	158	2	12			
850877N	Renault	Schlepper / TS	75-12	0								
850891N	Renault	Schlepper / TS	75-12	0	Sanden	SD7H15	158	2	12			
850877N	Renault	Schlepper / TS	75-14	0								
850891N	Renault	Schlepper / TS	75-14	0	Sanden	SD7H15	158	2	12			
850877N	Renault	Schlepper / TS	77-12	0								
850891N	Renault	Schlepper / TS	77-12	0	Sanden	SD7H15	158	2	12			
850877N	Renault	Schlepper / TS	77-14	0								
850891N	Renault	Schlepper / TS	77-14	0	Sanden	SD7H15	158	2	12			
850877N	Renault	Schlepper / TS	85-12	0								
850891N	Renault	Schlepper / TS	85-12	0	Sanden	SD7H15	158	2	12			
850877N	Renault	Schlepper / TS	85-14	0								
850891N	Renault	Schlepper / TS	85-14	0	Sanden	SD7H15	158	2	12			
850877N	Renault	Schlepper / TS	95-12	0								
850891N	Renault	Schlepper / TS	95-12	0	Sanden	SD7H15	158	2	12			
850877N	Renault	Schlepper / TS	95-14	0								
850891N	Renault	Schlepper / TS	95-14	0	Sanden	SD7H15	158	2	12			
850877N	Renault	Schlepper / TS	103-12	0								
850891N	Renault	Schlepper / TS	103-12	0	Sanden	SD7H15	158	2	12			
850877N	Renault	Schlepper / TS	103-14	0								
850891N	Renault	Schlepper / TS	103-14	0	Sanden	SD7H15	158	2	12			
850877N	Renault	Schlepper / TS	103-52	0								
850891N	Renault	Schlepper / TS	103-52	0	Sanden	SD7H15	158	2	12			
850877N	Renault	Schlepper / TS	103-54	0								

Dasis Nr.	Hersteller	Modell	Typ	KW	Herstellereinschränkung	Kompressor-ID	Riemenscheiben-Ø [mm]	Rippenanzahl	Spannung [V]	Zylinderkopf-ID (Kompressor)	Einlass-Ø [mm]	Auslass-Ø [mm]
850891N	Renault	Schlepper / TS	103-54	0	Sanden	SD7H15	158	2	12			
850877N	Renault	Schlepper / TS	106-54	0								
850891N	Renault	Schlepper / TS	106-54	0	Sanden	SD7H15	158	2	12			
850877N	Renault	Schlepper / TS	110-14	0								
850891N	Renault	Schlepper / TS	110-14	0	Sanden	SD7H15	158	2	12			
850877N	Renault	Schlepper / TS	110-54	0								
850891N	Renault	Schlepper / TS	110-54	0	Sanden	SD7H15	158	2	12			
850877N	Renault	Schlepper / TS	113-12	0								
850891N	Renault	Schlepper / TS	113-12	0	Sanden	SD7H15	158	2	12			
850877N	Renault	Schlepper / TS	113-14	0								
850891N	Renault	Schlepper / TS	113-14	0	Sanden	SD7H15	158	2	12			
850877N	Renault	Schlepper / TS	120-14	0								
850891N	Renault	Schlepper / TS	120-14	0	Sanden	SD7H15	158	2	12			
850877N	Renault	Schlepper / TS	120-54	0								
850891N	Renault	Schlepper / TS	120-54	0	Sanden	SD7H15	158	2	12			
850877N	Renault	Schlepper / TS	133-12	0								
850891N	Renault	Schlepper / TS	133-12	0	Sanden	SD7H15	158	2	12			
850877N	Renault	Schlepper / TS	133-14	0								
850891N	Renault	Schlepper / TS	133-14	0	Sanden	SD7H15	158	2	12			
850877N	Renault	Schlepper / TS	133-54	0								
850891N	Renault	Schlepper / TS	133-54	0	Sanden	SD7H15	158	2	12			
850877N	Renault	Schlepper / TX	75-32TX	0								
850891N	Renault	Schlepper / TX	75-32TX	0	Sanden	SD7H15	158	2	12			
850877N	Renault	Schlepper / TX	75-34TX	0								
850891N	Renault	Schlepper / TX	75-34TX	0	Sanden	SD7H15	158	2	12			
850877N	Renault	Schlepper / TX	80-12TX	0								
850891N	Renault	Schlepper / TX	80-12TX	0	Sanden	SD7H15	158	2	12			
850877N	Renault	Schlepper / TX	80-14TX	0								
850891N	Renault	Schlepper / TX	80-14TX	0	Sanden	SD7H15	158	2	12			
850877N	Renault	Schlepper / TX	85-12TX	0								
850891N	Renault	Schlepper / TX	85-12TX	0	Sanden	SD7H15	158	2	12			



Dasis Nr.	Hersteller	Modell	Typ	KW	Herstellereinschränkung	Kompressor-ID	Riemenscheiben-Ø [mm]	Rippenanzahl	Spannung [V]	Zylinderkopf-ID (Kompressor)	Einlass-Ø [mm]	Auslass-Ø [mm]
850877N	Renault	Schlepper / TX	85-14TX	0								
850891N	Renault	Schlepper / TX	85-14TX	0	Sanden	SD7H15	158	2	12			
850877N	Renault	Schlepper / TX	85-32TX	0								
850891N	Renault	Schlepper / TX	85-32TX	0	Sanden	SD7H15	158	2	12			
850877N	Renault	Schlepper / TX	85-34TX	0								
850891N	Renault	Schlepper / TX	85-34TX	0	Sanden	SD7H15	158	2	12			
850877N	Renault	Schlepper / TX	90-32TX	0								
850891N	Renault	Schlepper / TX	90-32TX	0	Sanden	SD7H15	158	2	12			
850877N	Renault	Schlepper / TX	90-34TX	0								
850891N	Renault	Schlepper / TX	90-34TX	0	Sanden	SD7H15	158	2	12			
850877N	Renault	Schlepper / TX	95-12TX	0								
850891N	Renault	Schlepper / TX	95-12TX	0	Sanden	SD7H15	158	2	12			
850877N	Renault	Schlepper / TX	95-14TX	0								
850891N	Renault	Schlepper / TX	95-14TX	0	Sanden	SD7H15	158	2	12			
850877N	Renault	Schlepper / TX	103-12TX	0								
850891N	Renault	Schlepper / TX	103-12TX	0	Sanden	SD7H15	158	2	12			
850877N	Renault	Schlepper / TX	103-14TX	0								
850891N	Renault	Schlepper / TX	103-14TX	0	Sanden	SD7H15	158	2	12			
850877N	Renault	Schlepper / TX	103-52TX	0								
850891N	Renault	Schlepper / TX	103-52TX	0	Sanden	SD7H15	158	2	12			
850877N	Renault	Schlepper / TX	103-54TX	0								
850891N	Renault	Schlepper / TX	103-54TX	0	Sanden	SD7H15	158	2	12			
850877N	Renault	Schlepper / TX	106-54TX	0								
850891N	Renault	Schlepper / TX	106-54TX	0	Sanden	SD7H15	158	2	12			
850877N	Renault	Schlepper / TX	110-14TX	0								
850891N	Renault	Schlepper / TX	110-14TX	0	Sanden	SD7H15	158	2	12			
850877N	Renault	Schlepper / TX	110-54TX	0								
850891N	Renault	Schlepper / TX	110-54TX	0	Sanden	SD7H15	158	2	12			
850877N	Renault	Schlepper / TX	113-12TX	0								
850891N	Renault	Schlepper / TX	113-12TX	0	Sanden	SD7H15	158	2	12			
850877N	Renault	Schlepper / TX	113-14TX	0								

Dasis Nr.	Hersteller	Modell	Typ	KW	Herstellereinschränkung	Kompressor-ID	Riemenscheiben-Ø [mm]	Rippenanzahl	Spannung [V]	Zylinderkopf-ID (Kompressor)	Einlass-Ø [mm]	Auslass-Ø [mm]
850891N	Renault	Schlepper / TX	113-14TX	0	Sanden	SD7H15	158	2	12			
850877N	Renault	Schlepper / TX	120-14TX	0								
850891N	Renault	Schlepper / TX	120-14TX	0	Sanden	SD7H15	158	2	12			
850877N	Renault	Schlepper / TX	120-54TX	0								
850891N	Renault	Schlepper / TX	120-54TX	0	Sanden	SD7H15	158	2	12			
850877N	Renault	Schlepper / TX	133-12TX	0								
850891N	Renault	Schlepper / TX	133-12TX	0	Sanden	SD7H15	158	2	12			
850877N	Renault	Schlepper / TX	133-14TX	0								
850891N	Renault	Schlepper / TX	133-14TX	0	Sanden	SD7H15	158	2	12			
850877N	Renault	Schlepper / TX	133-54TX	0								
850891N	Renault	Schlepper / TX	133-54TX	0	Sanden	SD7H15	158	2	12			
850877N	Renault	Schlepper / TX	145-14TX	0								
850891N	Renault	Schlepper / TX	145-14TX	0	Sanden	SD7H15	158	2	12			
850877N	Renault	Schlepper / TX	145-54TX	0								
850891N	Renault	Schlepper / TX	145-54TX	0	Sanden	SD7H15	158	2	12			
850877N	Renault	Schlepper / TX	155-54TX	0								
850891N	Renault	Schlepper / TX	155-54TX	0	Sanden	SD7H15	158	2	12			
850877N	Renault	Schlepper / TZ	110-54TZ	0								
850891N	Renault	Schlepper / TZ	110-54TZ	0	Sanden	SD7H15	158	2	12			
850877N	Renault	Schlepper / TZ	120-14TZ	0								
850891N	Renault	Schlepper / TZ	120-14TZ	0	Sanden	SD7H15	158	2	12			
850877N	Renault	Schlepper / TZ	120-54TZ	0								
850891N	Renault	Schlepper / TZ	120-54TZ	0	Sanden	SD7H15	158	2	12			
850877N	Renault	Schlepper / TZ	133-14TZ	0								
850891N	Renault	Schlepper / TZ	133-14TZ	0	Sanden	SD7H15	158	2	12			
850877N	Renault	Schlepper / TZ	133-54TZ	0								
850891N	Renault	Schlepper / TZ	133-54TZ	0	Sanden	SD7H15	158	2	12			
850877N	Renault	Schlepper / TZ	145-14TZ	0								
850891N	Renault	Schlepper / TZ	145-14TZ	0	Sanden	SD7H15	158	2	12			
850877N	Renault	Schlepper / TZ	145-54TZ	0								
850891N	Renault	Schlepper / TZ	145-54TZ	0	Sanden	SD7H15	158	2	12			

Dasis Nr.	Hersteller	Modell	Typ	KW	Herstellereinschränkung	Kompressor-ID	Riemenscheiben-Ø [mm]	Rippenanzahl	Spannung [V]	Zylinderkopf-ID (Kompressor)	Einlass-Ø [mm]	Auslass-Ø [mm]
850877N	Renault	Schlepper / TZ	155-54TZ	0								
850891N	Renault	Schlepper / TZ	155-54TZ	0	Sanden	SD7H15	158	2	12			
850891N	Renault	Schlepper / TZ	160-94TZ	0	Sanden	SD7H15	158	2	12			
850891N	Renault	Schlepper / TZ	175-74TZ	0	Sanden	SD7H15	158	2	12			
850891N	Renault	Schlepper / TZ	180-94TZ	0	Sanden	SD7H15	158	2	12			
850892N	Renault	Schlepper Obst Wein / Dionis	110	0	Sanden	7H15	132	2	12	MJ	15	15
850892N	Renault	Schlepper Obst Wein / Dionis	120	0	Sanden	7H15	132	2	12	MJ	15	15
850892N	Renault	Schlepper Obst Wein / Dionis	130	0	Sanden	7H15	132	2	12	MJ	15	15
850892N	Renault	Schlepper Obst Wein / Dionis	140	0	Sanden	7H15	132	2	12	MJ	15	15
850892N	Renault	Schlepper Obst Wein / Fructus	110	0	Sanden	7H15	132	2	12	MJ	15	15
850892N	Renault	Schlepper Obst Wein / Fructus	120	0	Sanden	7H15	132	2	12	MJ	15	15
850892N	Renault	Schlepper Obst Wein / Fructus	130	0	Sanden	7H15	132	2	12	MJ	15	15
850892N	Renault	Schlepper Obst Wein / Fructus	140	0	Sanden	7H15	132	2	12	MJ	15	15
850877N	Renault	Schlepper Obst Wein / TZ	160-94	0								
850877N	Renault	Schlepper Obst Wein / TZ	175-74	0								
850877N	Renault	Schlepper Obst Wein / TZ	180-94	0								
851111N	Same	Schlepper / Antares Inka	110	0	Sanden	SD5H14	132	2	12		14	14
851111N	Same	Schlepper / Antares Inka	130	0	Sanden	SD5H14	132	2	12		14	14
850327N	Same	Schlepper / Dorado	55	0	Sanden	SD7B10	115	2	12		14,9	12,2
850327N	Same	Schlepper / Dorado	56	0	Sanden	SD7B10	115	2	12		14,9	12,2
850327N	Same	Schlepper / Dorado	60	0	Sanden	SD7B10	115	2	12		14,9	12,2
850327N	Same	Schlepper / Dorado	65	0	Sanden	SD7B10	115	2	12		14,9	12,2
850327N	Same	Schlepper / Dorado	66	0	Sanden	SD7B10	115	2	12		14,9	12,2

Dasis Nr.	Hersteller	Modell	Typ	KW	Herstellereinschränkung	Kompressor-ID	Riemenscheiben-Ø [mm]	Rippenanzahl	Spannung [V]	Zylinderkopf-ID (Kompressor)	Einlass-Ø [mm]	Auslass-Ø [mm]
850327N	Same	Schlepper / Dorado	70	0	Sanden	SD7B10	115	2	12		14,9	12,2
850327N	Same	Schlepper / Dorado	75	0	Sanden	SD7B10	115	2	12		14,9	12,2
850327N	Same	Schlepper / Dorado	76	0	Sanden	SD7B10	115	2	12		14,9	12,2
850327N	Same	Schlepper / Dorado	85	0	Sanden	SD7B10	115	2	12		14,9	12,2
850327N	Same	Schlepper / Dorado	86	0	Sanden	SD7B10	115	2	12		14,9	12,2
850327N	Same	Schlepper / Dorado	90	0	Sanden	SD7B10	115	2	12		14,9	12,2
850327N	Same	Schlepper / Dorado	100	0	Sanden	SD7B10	115	2	12		14,9	12,2
850884N	Same	Schlepper / Explorer mkll	60	0	Sanden	SD5H14	132	2	12	N	13,5	13,5
850884N	Same	Schlepper / Explorer mkll	60SP	0	Sanden	SD5H14	132	2	12	N	13,5	13,5
850884N	Same	Schlepper / Explorer mkll	70	0	Sanden	SD5H14	132	2	12	N	13,5	13,5
850884N	Same	Schlepper / Explorer mkll	70SP	0	Sanden	SD5H14	132	2	12	N	13,5	13,5
850884N	Same	Schlepper / Explorer mkll	80	0	Sanden	SD5H14	132	2	12	N	13,5	13,5
850884N	Same	Schlepper / Explorer mkll	80SP	0	Sanden	SD5H14	132	2	12	N	13,5	13,5
850884N	Same	Schlepper / Explorer mkll	90	0	Sanden	SD5H14	132	2	12	N	13,5	13,5
850327N	Same	Schlepper / Golden	60	0	Sanden	SD7B10	115	2	12		14,9	12,2
850327N	Same	Schlepper / Golden	65	0	Sanden	SD7B10	115	2	12		14,9	12,2
850327N	Same	Schlepper / Golden	75	0	Sanden	SD7B10	115	2	12		14,9	12,2
850327N	Same	Schlepper / Golden	85	0	Sanden	SD7B10	115	2	12		14,9	12,2
851719N	Same	Schlepper / Iron	100	0	Sanden	SD7H15	150	2	12	KG		1
851719N	Same	Schlepper / Iron	110	0	Sanden	SD7H15	150	2	12	KG		1
851719N	Same	Schlepper / Iron	115	0	Sanden	SD7H15	150	2	12	KG		1
851719N	Same	Schlepper / Iron	125	0	Sanden	SD7H15	150	2	12	KG		1
851719N	Same	Schlepper / Iron	130	0	Sanden	SD7H15	150	2	12	KG		1

Dasis Nr.	Hersteller	Modell	Typ	KW	Herstellereinschränkung	Kompressor-ID	Riemenscheiben-Ø [mm]	Rippenanzahl	Spannung [V]	Zylinderkopf-ID (Kompressor)	Einlass-Ø [mm]	Auslass-Ø [mm]
851719N	Same	Schlepper / Iron	140	0	Sanden	SD7H15	150	2	12	KG		1
851719N	Same	Schlepper / Iron	150	0	Sanden	SD7H15	150	2	12	KG		1
851719N	Same	Schlepper / Iron	160	0	Sanden	SD7H15	150	2	12	KG		1
851719N	Same	Schlepper / Iron	170	0	Sanden	SD7H15	150	2	12	KG		1
851719N	Same	Schlepper / Iron	175	0	Sanden	SD7H15	150	2	12	KG		1
851719N	Same	Schlepper / Iron	185	0	Sanden	SD7H15	150	2	12	KG		1
851111N	Same	Schlepper / Laser	85	0	Sanden	SD5H14	132	2	12		14	14
851111N	Same	Schlepper / Laser	90	0	Sanden	SD5H14	132	2	12		14	14
851111N	Same	Schlepper / Laser	100	0	Sanden	SD5H14	132	2	12		14	14
851111N	Same	Schlepper / Laser	110	0	Sanden	SD5H14	132	2	12		14	14
851111N	Same	Schlepper / Laser	130	0	Sanden	SD5H14	132	2	12		14	14
851111N	Same	Schlepper / Laser	150	0	Sanden	SD5H14	132	2	12		14	14
850892N	Same	Schlepper / Rubin	120	0	Sanden	7H15	132	2	12	MJ	15	15
850892N	Same	Schlepper / Rubin	135	0	Sanden	7H15	132	2	12	MJ	15	15
850892N	Same	Schlepper / Rubin	150	0	Sanden	7H15	132	2	12	MJ	15	15
850892N	Same	Schlepper / Rubin	160	0	Sanden	7H15	132	2	12	MJ	15	15
850892N	Same	Schlepper / Rubin	180	0	Sanden	7H15	132	2	12	MJ	15	15
850892N	Same	Schlepper / Rubin	200	0	Sanden	7H15	132	2	12	MJ	15	15
851699N	Same	Schlepper / Silver	80	0	Sanden	SD7H15HD	132	2	12	CB	14	14
851699N	Same	Schlepper / Silver	85	0	Sanden	SD7H15HD	132	2	12	CB	14	14
851699N	Same	Schlepper / Silver	90	0	Sanden	SD7H15HD	132	2	12	CB	14	14
851699N	Same	Schlepper / Silver	95	0	Sanden	SD7H15HD	132	2	12	CB	14	14
851699N	Same	Schlepper / Silver	100.4	0	Sanden	SD7H15HD	132	2	12	CB	14	14
851699N	Same	Schlepper / Silver	100.6	0	Sanden	SD7H15HD	132	2	12	CB	14	14
851699N	Same	Schlepper / Silver	105	0	Sanden	SD7H15HD	132	2	12	CB	14	14
851699N	Same	Schlepper / Silver	110	0	Sanden	SD7H15HD	132	2	12	CB	14	14
851699N	Same	Schlepper / Silver	115	0	Sanden	SD7H15HD	132	2	12	CB	14	14
851699N	Same	Schlepper / Silver	130	0	Sanden	SD7H15HD	132	2	12	CB	14	14
851699N	Same	Schlepper / Silver	160	0	Sanden	SD7H15HD	132	2	12	CB	14	14

Dasis Nr.	Hersteller	Modell	Typ	KW	Herstellereinschränkung	Kompressor-ID	Riemenscheiben-Ø [mm]	Rippenanzahl	Spannung [V]	Zylinderkopf-ID (Kompressor)	Einlass-Ø [mm]	Auslass-Ø [mm]
851699N	Same	Schlepper / Silver	180	0	Sanden	SD7H15HD	132	2	12	CB	14	14
851111N	Same	Schlepper / Titan	145	0	Sanden	SD5H14	132	2	12		14	14
851111N	Same	Schlepper / Titan	150	0	Sanden	SD5H14	132	2	12		14	14
851111N	Same	Schlepper / Titan	160	0	Sanden	SD5H14	132	2	12		14	14
851111N	Same	Schlepper / Titan	165	0	Sanden	SD5H14	132	2	12		14	14
851111N	Same	Schlepper / Titan	190	0	Sanden	SD5H14	132	2	12		14	14
852992N	Steyr	Schlepper / 4000	4095 Multi	0	Sanden	SD7H15	112	6	12		13	13
852992N	Steyr	Schlepper / 4000	4105 Multi	0	Sanden	SD7H15	112	6	12		13	13
852992N	Steyr	Schlepper / 4000	4115 Multi	0	Sanden	SD7H15	112	6	12		13	13
850874N	Steyr	Schlepper / 9000	9100	0	Sanden	SD7H15HD	152	2	12	MD	14,5	14,5
850874N	Steyr	Schlepper / 9000	9105	0	Sanden	SD7H15HD	152	2	12	MD	14,5	14,5
850874N	Steyr	Schlepper / 9000	9115	0	Sanden	SD7H15HD	152	2	12	MD	14,5	14,5
850874N	Steyr	Schlepper / 9000	9125	0	Sanden	SD7H15HD	152	2	12	MD	14,5	14,5
850874N	Steyr	Schlepper / 9000	9145	0	Sanden	SD7H15HD	152	2	12	MD	14,5	14,5
850874N	Steyr	Schlepper / 9000	9155	0	Sanden	SD7H15HD	152	2	12	MD	14,5	14,5
850874N	Steyr	Schlepper / CS	78	0	Sanden	SD7H15HD	152	2	12	MD	14,5	14,5
851703N	Steyr	Schlepper / CS	78	0	Seltec	TM-16HD	135	2	12		13	16
850874N	Steyr	Schlepper / CS	86	0	Sanden	SD7H15HD	152	2	12	MD	14,5	14,5
851703N	Steyr	Schlepper / CS	86	0	Seltec	TM-16HD	135	2	12		13	16
850874N	Steyr	Schlepper / CS	94	0	Sanden	SD7H15HD	152	2	12	MD	14,5	14,5
851703N	Steyr	Schlepper / CS	94	0	Seltec	TM-16HD	135	2	12		13	16
850874N	Steyr	Schlepper / CS	100	0	Sanden	SD7H15HD	152	2	12	MD	14,5	14,5
851703N	Steyr	Schlepper / CS	100	0	Seltec	TM-16HD	135	2	12		13	16
850874N	Steyr	Schlepper / CS	110	0	Sanden	SD7H15HD	152	2	12	MD	14,5	14,5
851703N	Steyr	Schlepper / CS	110	0	Seltec	TM-16HD	135	2	12		13	16
850874N	Steyr	Schlepper / CS	120	0	Sanden	SD7H15HD	152	2	12	MD	14,5	14,5
851703N	Steyr	Schlepper / CS	120	0	Seltec	TM-16HD	135	2	12		13	16
850874N	Steyr	Schlepper / CS	130	0	Sanden	SD7H15HD	152	2	12	MD	14,5	14,5
851703N	Steyr	Schlepper / CS	130	0	Seltec	TM-16HD	135	2	12		13	16
850874N	Steyr	Schlepper / CS	150	0	Sanden	SD7H15HD	152	2	12	MD	14,5	14,5
851703N	Steyr	Schlepper / CS	150	0	Seltec	TM-16HD	135	2	12		13	16

Dasis Nr.	Hersteller	Modell	Typ	KW	Herstellereinschränkung	Kompressor-ID	Riemenscheiben-Ø [mm]	Rippenanzahl	Spannung [V]	Zylinderkopf-ID (Kompressor)	Einlass-Ø [mm]	Auslass-Ø [mm]
852996N	Steyr	Schlepper / CVT	6185	0	Sanden	SD7H15	119	10	12		12	15
852996N	Steyr	Schlepper / CVT	6200	0	Sanden	SD7H15	119	10	12		12	15
852996N	Steyr	Schlepper / CVT	6220	0	Sanden	SD7H15	119	10	12		12	15
852996N	Steyr	Schlepper / CVT	6240	0	Sanden	SD7H15	119	10	12		12	15
850874N	Steyr	Schlepper / CVX	V120	0	Sanden	SD7H15HD	152	2	12	MD	14,5	14,5
850874N	Steyr	Schlepper / CVX	V130	0	Sanden	SD7H15HD	152	2	12	MD	14,5	14,5
850874N	Steyr	Schlepper / CVX	V150	0	Sanden	SD7H15HD	152	2	12	MD	14,5	14,5
850874N	Steyr	Schlepper / CVX	V170	0	Sanden	SD7H15HD	152	2	12	MD	14,5	14,5
850874N	Steyr	Schlepper / CVX	V1135	0	Sanden	SD7H15HD	152	2	12	MD	14,5	14,5
850874N	Steyr	Schlepper / CVX	V1145	0	Sanden	SD7H15HD	152	2	12	MD	14,5	14,5
850874N	Steyr	Schlepper / CVX	V1155	0	Sanden	SD7H15HD	152	2	12	MD	14,5	14,5
850874N	Steyr	Schlepper / CVX	V1170	0	Sanden	SD7H15HD	152	2	12	MD	14,5	14,5
850874N	Steyr	Schlepper / CVX	V1190	0	Sanden	SD7H15HD	152	2	12	MD	14,5	14,5
851754N	Timberjack	Forstmaschine / 810-1710	810	0	Denso	10PA17C	146	8	24			
851754N	Timberjack	Forstmaschine / 810-1710	1110	0	Denso	10PA17C	146	8	24			
851754N	Timberjack	Forstmaschine / 810-1710	1410	0	Denso	10PA17C	146	8	24			
851754N	Timberjack	Forstmaschine / 810-1710	1710	0	Denso	10PA17C	146	8	24			
851754N	Timberjack	Schlepper / 770-1470	770	0	Denso	10PA17C	146	8	24			
851754N	Timberjack	Schlepper / 770-1470	1070	0	Denso	10PA17C	146	8	24			
851754N	Timberjack	Schlepper / 770-1470	1270	0	Denso	10PA17C	146	8	24			
851754N	Timberjack	Schlepper / 770-1470	1470	0	Denso	10PA17C	146	8	24			
851703N	Valtra Valmet	Schlepper / 700	700	0	Seltec	TM-16HD	135	2	12		13	16
851703N	Valtra Valmet	Schlepper / 800	800	0	Seltec	TM-16HD	135	2	12		13	16
851703N	Valtra Valmet	Schlepper / 900	900	0	Seltec	TM-16HD	135	2	12		13	16
851714N	Valtra Valmet	Schlepper / 3000	3300	0	Delphi	SP-10	121	2	12		18	15
851714N	Valtra Valmet	Schlepper / 3000	3400	0	Delphi	SP-10	121	2	12		18	15
851714N	Valtra Valmet	Schlepper / 3000	3500	0	Delphi	SP-10	121	2	12		18	15
851698N	Valtra Valmet	Schlepper / 6000	6000	0	Sanden	SD7H15	132	2	12			

Dasis Nr.	Hersteller	Modell	Typ	KW	Herstellereinschränkung	Kompressor-ID	Riemenscheiben-Ø [mm]	Rippenanzahl	Spannung [V]	Zylinderkopf-ID (Kompressor)	Einlass-Ø [mm]	Auslass-Ø [mm]
851698N	Valtra Valmet	Schlepper / 6000	6200	0	Sanden	SD7H15	132	2	12			
851698N	Valtra Valmet	Schlepper / 6000	6800	0	Sanden	SD7H15	132	2	12			
851698N	Valtra Valmet	Schlepper / 6000	6900	0	Sanden	SD7H15	132	2	12			
858456N	Valtra Valmet	Schlepper / 8000	8050	0	Seltec	TM-15HD	135	2	12		16	14
858456N	Valtra Valmet	Schlepper / 8000	8150	0	Seltec	TM-15HD	135	2	12		16	14
851698N	Valtra Valmet	Schlepper / 8000	8200	0	Sanden	SD7H15	132	2	12			
851698N	Valtra Valmet	Schlepper / 8000	8300T	0	Sanden	SD7H15	132	2	12			
851698N	Valtra Valmet	Schlepper / 8000	8400	0	Sanden	SD7H15	132	2	12			
858456N	Valtra Valmet	Schlepper / 8000	8450	0	Seltec	TM-15HD	135	2	12		16	14
858456N	Valtra Valmet	Schlepper / 8000	8550	0	Seltec	TM-15HD	135	2	12		16	14
858456N	Valtra Valmet	Schlepper / 8000	8750	0	Seltec	TM-15HD	135	2	12		16	14
851698N	Valtra Valmet	Schlepper / 8000	8800	0	Sanden	SD7H15	132	2	12			
851698N	Valtra Valmet	Schlepper / A	85	0	Sanden	SD7H15	132	2	12			
851107N	Valtra Valmet	Schlepper / A	85	0	Sanden	SD7H15	132	2	12		22	19
851698N	Valtra Valmet	Schlepper / A	120	0	Sanden	SD7H15	132	2	12			
851107N	Valtra Valmet	Schlepper / A	120	0	Sanden	SD7H15	132	2	12		22	19
851698N	Valtra Valmet	Schlepper / A	120E	0	Sanden	SD7H15	132	2	12			
851107N	Valtra Valmet	Schlepper / A	120E	0	Sanden	SD7H15	132	2	12		22	19
850713N	Valtra Valmet	Schlepper / Forest	820	0		ohne	130	2			16	20
851708N	Valtra Valmet	Schlepper / Forest	820	0	Seltec	TM-16HD	135	2	24			
851107N	Valtra Valmet	Schlepper / M	120	0	Sanden	SD7H15	132	2	12		22	19
852917N	Valtra Valmet	Schlepper / N	93	0	Sanden	SD7H15	119	8	12		16	16
852917N	Valtra Valmet	Schlepper / N	103	0	Sanden	SD7H15	119	8	12		16	16
852917N	Valtra Valmet	Schlepper / N	113	0	Sanden	SD7H15	119	8	12		16	16
851107N	Valtra Valmet	Schlepper / N	121	0	Sanden	SD7H15	132	2	12		22	19
852917N	Valtra Valmet	Schlepper / N	123	0	Sanden	SD7H15	119	8	12		16	16
852917N	Valtra Valmet	Schlepper / N	143	0	Sanden	SD7H15	119	8	12		16	16
852917N	Valtra Valmet	Schlepper / N	163	0	Sanden	SD7H15	119	8	12		16	16
851785N	Valtra Valmet	Schlepper / S	230	0	Sanden	SD7H15	120	8	12	JD	12,8	14,5
851713N	Valtra Valmet	Schlepper / S	232	176	Sanden	SD7H15	120	6	12		17,4	14,4
851785N	Valtra Valmet	Schlepper / S	240	0	Sanden	SD7H15	120	8	12	JD	12,8	14,5



Dasis Nr.	Hersteller	Modell	Typ	KW	Herstellereinschränkung	Kompressor-ID	Riemenscheiben-Ø [mm]	Rippenanzahl	Spannung [V]	Zylinderkopf-ID (Kompressor)	Einlass-Ø [mm]	Auslass-Ø [mm]
851768N	Valtra Valmet	Schlepper / S	260	0	Sanden	SD7H15	119	8	12			
851713N	Valtra Valmet	Schlepper / S	262	0	Sanden	SD7H15	120	6	12		17,4	14,4
851785N	Valtra Valmet	Schlepper / S	280	0	Sanden	SD7H15	120	8	12	JD	12,8	14,5
851713N	Valtra Valmet	Schlepper / S	292	0	Sanden	SD7H15	120	6	12		17,4	14,4
851713N	Valtra Valmet	Schlepper / S	322	0	Sanden	SD7H15	120	6	12		17,4	14,4
851713N	Valtra Valmet	Schlepper / S	352	0	Sanden	SD7H15	120	6	12		17,4	14,4
851785N	Valtra Valmet	Schlepper / S	Diverse	0	Sanden	SD7H15	120	8	12	JD	12,8	14,5
851698N	Valtra Valmet	Schlepper / T	130	0	Sanden	SD7H15	132	2	12			
851107N	Valtra Valmet	Schlepper / T	130	0	Sanden	SD7H15	132	2	12		22	19
852917N	Valtra Valmet	Schlepper / T	133	0	Sanden	SD7H15	119	8	12		16	16
852925N	Valtra Valmet	Schlepper / T	144	0	Denso	10S17C	156	6	12		15	18
852917N	Valtra Valmet	Schlepper / T	153	0	Sanden	SD7H15	119	8	12		16	16
852925N	Valtra Valmet	Schlepper / T	154	0	Denso	10S17C	156	6	12		15	18
851698N	Valtra Valmet	Schlepper / T	160	0	Sanden	SD7H15	132	2	12			
851107N	Valtra Valmet	Schlepper / T	160	0	Sanden	SD7H15	132	2	12		22	19
852917N	Valtra Valmet	Schlepper / T	163	0	Sanden	SD7H15	119	8	12		16	16
852917N	Valtra Valmet	Schlepper / T	173	0	Sanden	SD7H15	119	8	12		16	16
852925N	Valtra Valmet	Schlepper / T	174	0	Denso	10S17C	156	6	12		15	18
851698N	Valtra Valmet	Schlepper / T	180	0	Sanden	SD7H15	132	2	12			
851107N	Valtra Valmet	Schlepper / T	180	0	Sanden	SD7H15	132	2	12		22	19
852917N	Valtra Valmet	Schlepper / T	183	0	Sanden	SD7H15	119	8	12		16	16
851698N	Valtra Valmet	Schlepper / T	190	0	Sanden	SD7H15	132	2	12			
851107N	Valtra Valmet	Schlepper / T	190	0	Sanden	SD7H15	132	2	12		22	19
852917N	Valtra Valmet	Schlepper / T	193	0	Sanden	SD7H15	119	8	12		16	16
852925N	Valtra Valmet	Schlepper / T	194	0	Denso	10S17C	156	6	12		15	18
852917N	Valtra Valmet	Schlepper / T	203	0	Sanden	SD7H15	119	8	12		16	16
852917N	Valtra Valmet	Schlepper / T	213	0	Sanden	SD7H15	119	8	12		16	16
852925N	Valtra Valmet	Schlepper / T	214	0	Denso	10S17C	156	6	12		15	18
852925N	Valtra Valmet	Schlepper / T	234	0	Denso	10S17C	156	6	12		15	18
852925N	Valtra Valmet	Schlepper / T	254	0	Denso	10S17C	156	6	12		15	18
851773N	Volvo	Bagger 360 ° / 6000	6300	0	Sanden	SD508	132	2	24			

Dasis Nr.	Hersteller	Modell	Typ	KW	Herstellereinschränkung	Kompressor-ID	Riemenscheiben-Ø [mm]	Rippenanzahl	Spannung [V]	Zylinderkopf-ID (Kompressor)	Einlass-Ø [mm]	Auslass-Ø [mm]
851773N	Volvo	Baggerlader / 600	616B	0	Sanden	SD508	132	2	24			
851773N	Volvo	Baggerlader / 600	646	0	Sanden	SD508	132	2	24			
851773N	Volvo	Baggerlader / 4300-4000	4200	0	Sanden	SD508	132	2	24			
851773N	Volvo	Baggerlader / 4300-4000	4300	0	Sanden	SD508	132	2	24			
851708N	Volvo	Motorgrader / 700	G720A	0	Seltec	TM-16HD	135	2	24			
850585N	Volvo	Motorgrader / C	A25C	0								
850585N	Volvo	Motorgrader / C	A30C	0								
850585N	Volvo	Motorgrader / C	A40C	0								
850585N	Volvo	Muldenkipper / C	A250	0								
850585N	Volvo	Muldenkipper / C	A300	0								
850585N	Volvo	Muldenkipper / C	A400	0								
851773N	Volvo	Schaufellader / 2600	2650	0	Sanden	SD508	132	2	24			
851773N	Volvo	Schaufellader / 2600	2654	0	Sanden	SD508	132	2	24			
850670N	Volvo	Schaufellader / C	L1200C	0	Sanden	SD7H15	132	8	24	WV	17,7	14,6
851707N	Volvo	Schaufellader / D	L50D	0	Sanden	SD7H15	119	8	12	GH	11	11
851707N	Volvo	Schaufellader / D	L70D	0	Sanden	SD7H15	119	8	12	GH	11	11
851707N	Volvo	Schaufellader / D	L90D	0	Sanden	SD7H15	119	8	12	GH	11	11
851707N	Volvo	Schaufellader / D	L120D	0	Sanden	SD7H15	119	8	12	GH	11	11
851707N	Volvo	Schaufellader / D	L150D	0	Sanden	SD7H15	119	8	12	GH	11	11
852842N	Volvo	Schaufellader / E	140Serie	0	Delphi-Harrison	V5	132		24			
852842N	Volvo	Schaufellader / E	150Serie	0	Delphi-Harrison	V5	132		24			
852842N	Volvo	Schaufellader / E	210Serie	0	Delphi-Harrison	V5	132		24			
852842N	Volvo	Schaufellader / E	240Serie	0	Delphi-Harrison	V5	132		24			
852842N	Volvo	Schaufellader / E	290Serie	0	Delphi-Harrison	V5	132		24			
852842N	Volvo	Schaufellader / E	360Serie	0	Delphi-Harrison	V5	132		24			
852842N	Volvo	Schaufellader / E	460Serie	0	Delphi-Harrison	V5	132		24			
851707N	Volvo	Schaufellader / E	L60E	0	Sanden	SD7H15	119	8	12	GH	11	11
850670N	Volvo	Schaufellader / E	L60E	0	Sanden	SD7H15	132	8	24	WV	17,7	14,6

Dasis Nr.	Hersteller	Modell	Typ	KW	Herstellereinschränkung	Kompressor-ID	Riemenscheiben-Ø [mm]	Rippenanzahl	Spannung [V]	Zylinderkopf-ID (Kompressor)	Einlass-Ø [mm]	Auslass-Ø [mm]
851707N	Volvo	Schaufellader / E	L70E	0	Sanden	SD7H15	119	8	12	GH	11	11
850670N	Volvo	Schaufellader / E	L70E	0	Sanden	SD7H15	132	8	24	WV	17,7	14,6
851707N	Volvo	Schaufellader / E	L90E	0	Sanden	SD7H15	119	8	12	GH	11	11
850670N	Volvo	Schaufellader / E	L90E	0	Sanden	SD7H15	132	8	24	WV	17,7	14,6
851707N	Volvo	Schaufellader / E	L110E	0	Sanden	SD7H15	119	8	12	GH	11	11
850670N	Volvo	Schaufellader / E	L110E	0	Sanden	SD7H15	132	8	24	WV	17,7	14,6
851707N	Volvo	Schaufellader / E	L120E	0	Sanden	SD7H15	119	8	12	GH	11	11
850670N	Volvo	Schaufellader / E	L120E	0	Sanden	SD7H15	132	8	24	WV	17,7	14,6
851707N	Volvo	Schaufellader / E	L150E	0	Sanden	SD7H15	119	8	12	GH	11	11
850670N	Volvo	Schaufellader / E	L150E	0	Sanden	SD7H15	132	8	24	WV	17,7	14,6
851707N	Volvo	Schaufellader / E	L180E	0	Sanden	SD7H15	119	8	12	GH	11	11
850670N	Volvo	Schaufellader / E	L180E	0	Sanden	SD7H15	132	8	24	WV	17,7	14,6
851707N	Volvo	Schaufellader / E	L220E	0	Sanden	SD7H15	119	8	12	GH	11	11
850670N	Volvo	Schaufellader / E	L220E	0	Sanden	SD7H15	132	8	24	WV	17,7	14,6
851707N	Volvo	Schaufellader / E	L330E	0	Sanden	SD7H15	119	8	12	GH	11	11
850670N	Volvo	Schaufellader / E	L330E	0	Sanden	SD7H15	132	8	24	WV	17,7	14,6
850552N	Volvo	Schaufellader / L	50	0		SD7H15	132	8	24		16	14
851773N	Volvo	Schaufellader / L	50	0	Sanden	SD508	132	2	24			
850552N	Volvo	Schaufellader / L	70	0		SD7H15	132	8	24		16	14
851773N	Volvo	Schaufellader / L	70	0	Sanden	SD508	132	2	24			
850552N	Volvo	Schaufellader / L	90	0		SD7H15	132	8	24		16	14
851773N	Volvo	Schaufellader / L	90	0	Sanden	SD508	132	2	24			
850552N	Volvo	Schaufellader / L	120	0		SD7H15	132	8	24		16	14
851773N	Volvo	Schaufellader / L	120	0	Sanden	SD508	132	2	24			
851773N	Volvo	Schaufellader / L	150	0	Sanden	SD508	132	2	24			
850552N	Volvo	Schaufellader / L	170	0		SD7H15	132	8	24		16	14
850585N	Volvo	Schaufellader / L	180	0								
851773N	Volvo	Schlepper / 2000-2654	2650	0	Sanden	SD508	132	2	24			
851773N	Volvo	Schlepper / 2000-2654	2654	0	Sanden	SD508	132	2	24			
851738N	Zetor	Schlepper / 3000	3320	0	Sanden	SD7H15	132	2	12	JD		
851738N	Zetor	Schlepper / 3000	3321	0	Sanden	SD7H15	132	2	12	JD		

Dasis Nr.	Hersteller	Modell	Typ	KW	Herstellereinschränkung	Kompressor-ID	Riemenscheiben-Ø [mm]	Rippenanzahl	Spannung [V]	Zylinderkopf-ID (Kompressor)	Einlass-Ø [mm]	Auslass-Ø [mm]
851738N	Zetor	Schlepper / 3000	3340	0	Sanden	SD7H15	132	2	12	JD		
851738N	Zetor	Schlepper / 3000	3341	0	Sanden	SD7H15	132	2	12	JD		
851738N	Zetor	Schlepper / 4000	4320	0	Sanden	SD7H15	132	2	12	JD		
851738N	Zetor	Schlepper / 4000	4321	0	Sanden	SD7H15	132	2	12	JD		
851738N	Zetor	Schlepper / 4000	4340	0	Sanden	SD7H15	132	2	12	JD		
851738N	Zetor	Schlepper / 4000	4341	0	Sanden	SD7H15	132	2	12	JD		
851738N	Zetor	Schlepper / 6000	6320	0	Sanden	SD7H15	132	2	12	JD		
851738N	Zetor	Schlepper / 6000	6321	0	Sanden	SD7H15	132	2	12	JD		
851738N	Zetor	Schlepper / 6000	6340	0	Sanden	SD7H15	132	2	12	JD		
851738N	Zetor	Schlepper / 6000	6341	0	Sanden	SD7H15	132	2	12	JD		
851738N	Zetor	Schlepper / 7000	7320	0	Sanden	SD7H15	132	2	12	JD		
851738N	Zetor	Schlepper / 7000	7321	0	Sanden	SD7H15	132	2	12	JD		
851738N	Zetor	Schlepper / 7000	7340	0	Sanden	SD7H15	132	2	12	JD		
851738N	Zetor	Schlepper / 7000	7341	0	Sanden	SD7H15	132	2	12	JD		

Dasis Nr.	Hersteller	Modell	Typ	KW	Netzlänge [mm]	Netzbreite [mm]	Netztiefe [mm]	Netzmaße	mit / ohne Trockner	für OE-Nummer
420011N	Bateman	Selbstfahrende Farbspritze / RB	15	0						
420011N	Bateman	Selbstfahrende Farbspritze / RB	16	0						
420011N	Bateman	Selbstfahrende Farbspritze / RB	25	0						
422012N	Braud NH	Selbstfahrende Farbspritze / SB	33	0	490	406	51		ohne Trockner	
422012N	Braud NH	Selbstfahrende Farbspritze / SB	35	0	490	406	51		ohne Trockner	
422012N	Braud NH	Selbstfahrende Farbspritze / SB	36	0	490	406	51		ohne Trockner	
422012N	Braud NH	Selbstfahrende Farbspritze / SB	52	0	490	406	51		ohne Trockner	
422012N	Braud NH	Selbstfahrende Farbspritze / SB	53	0	490	406	51		ohne Trockner	
422012N	Braud NH	Selbstfahrende Farbspritze / SB	54	0	490	406	51		ohne Trockner	
422012N	Braud NH	Selbstfahrende Farbspritze / SB	55	0	490	406	51		ohne Trockner	
422012N	Braud NH	Selbstfahrende Farbspritze / SB	56	0	490	406	51		ohne Trockner	
422012N	Braud NH	Selbstfahrende Farbspritze / SB	58	0	490	406	51		ohne Trockner	
422012N	Braud NH	Selbstfahrende Farbspritze / SB	60	0	490	406	51		ohne Trockner	
422012N	Braud NH	Selbstfahrende Farbspritze / SB	62	0	490	406	51		ohne Trockner	
422012N	Braud NH	Selbstfahrende Farbspritze / SB	64	0	490	406	51		ohne Trockner	
422012N	Braud NH	Selbstfahrende Farbspritze / SB	65	0	490	406	51		ohne Trockner	
422012N	Braud NH	Selbstfahrende Farbspritze / VL	610	0	490	406	51		ohne Trockner	
422012N	Braud NH	Selbstfahrende Farbspritze / VL	620	0	490	406	51		ohne Trockner	
422012N	Braud NH	Selbstfahrende Farbspritze / VL	630	0	490	406	51		ohne Trockner	
422012N	Braud NH	Selbstfahrende Farbspritze / VL	640	0	490	406	51		ohne Trockner	
422012N	Braud NH	Selbstfahrende Farbspritze / VL	660	0	490	406	51		ohne Trockner	

Dasis Nr.	Hersteller	Modell	Typ	KW	Netzlänge [mm]	Netzbreite [mm]	Netztiefe [mm]	Netzmaße	mit / ohne Trockner	für OE-Nummer
422045N	Case International IHC	Baggerlader / CX	130	0	630	350	26		ohne Trockner	47758300 47791675 KHR13070 KHR13071
422045N	Case International IHC	Baggerlader / CX	160	0	630	350	26		ohne Trockner	47758300 47791675 KHR13070 KHR13071
422045N	Case International IHC	Baggerlader / CX	180	0	630	350	26		ohne Trockner	47758300 47791675 KHR13070 KHR13071
422045N	Case International IHC	Baggerlader / CX	210	0	630	350	26		ohne Trockner	47758300 47791675 KHR13070 KHR13071
422045N	Case International IHC	Baggerlader / CX	220	0	630	350	26		ohne Trockner	47758300 47791675 KHR13070 KHR13071
422045N	Case International IHC	Baggerlader / CX	230	0	630	350	26		ohne Trockner	47758300 47791675 KHR13070 KHR13071
422045N	Case International IHC	Baggerlader / CX	240	0	630	350	26		ohne Trockner	47758300 47791675 KHR13070 KHR13071
422045N	Case International IHC	Baggerlader / CX	250	0	630	350	26		ohne Trockner	47758300 47791675 KHR13070 KHR13071
422045N	Case International IHC	Baggerlader / CX	260	0	630	350	26		ohne Trockner	47758300 47791675 KHR13070 KHR13071
422045N	Case International IHC	Baggerlader / CX	290	0	630	350	26		ohne Trockner	47758300 47791675 KHR13070 KHR13071
422045N	Case International IHC	Baggerlader / CX	300	0	630	350	26		ohne Trockner	47758300 47791675 KHR13070 KHR13071
422045N	Case International IHC	Baggerlader / CX	350	0	630	350	26		ohne Trockner	47758300 47791675 KHR13070 KHR13071
422045N	Case International IHC	Baggerlader / CX	370	0	630	350	26		ohne Trockner	47758300 47791675 KHR13070 KHR13071
422045N	Case International IHC	Baggerlader / CX	470	0	630	350	26		ohne Trockner	47758300 47791675 KHR13070 KHR13071
422045N	Case International IHC	Baggerlader / CX	490	0	630	350	26		ohne Trockner	47758300 47791675 KHR13070 KHR13071
422045N	Case International IHC	Baggerlader / CX	500	0	630	350	26		ohne Trockner	47758300 47791675 KHR13070 KHR13071
452004N	Case International IHC	Mähdrescher / 7010-9010	7010	0	1117	508	50		mit Trockner	
452004N	Case International IHC	Mähdrescher / 7010-9010	7120	0	1117	508	50		mit Trockner	
452004N	Case International IHC	Mähdrescher / 7010-9010	7230	0	1117	508	50		mit Trockner	
452004N	Case International IHC	Mähdrescher / 7010-9010	8010	0	1117	508	50		mit Trockner	
452004N	Case International IHC	Mähdrescher / 7010-9010	9010	0	1117	508	50		mit Trockner	
442005N	Case International IHC	Schlepper	Diverse	0	341	427	22			

Dasis Nr.	Hersteller	Modell	Typ	KW	Netzlänge [mm]	Netzbreite [mm]	Netztiefe [mm]	Netzmaße	mit / ohne Trockner	für OE-Nummer
442004N	Case International IHC	Schlepper	Diverse	0	351	403	22			
422001N	Case International IHC	Schlepper / 186-996	856	0	395	457	38		ohne Trockner	3402565R1 3402595R1
422001N	Case International IHC	Schlepper / 186-996	955	0	395	457	38		ohne Trockner	3402565R1 3402595R1
422001N	Case International IHC	Schlepper / 186-996	956	0	395	457	38		ohne Trockner	3402565R1 3402595R1
422001N	Case International IHC	Schlepper / 1046-1896	1055	0	395	457	38		ohne Trockner	3402565R1 3402595R1
422001N	Case International IHC	Schlepper / 1046-1896	1056	0	395	457	38		ohne Trockner	3402565R1 3402595R1
422001N	Case International IHC	Schlepper / 1046-1896	1255	0	395	457	38		ohne Trockner	3402565R1 3402595R1
422001N	Case International IHC	Schlepper / 1046-1896	1455	0	395	457	38		ohne Trockner	3402565R1 3402595R1
422032N	Case International IHC	Schlepper / 4000-4894	4030	0	295	275	18			
420036N	Case International IHC	Schlepper / 4000-4894	4210	0						
420036N	Case International IHC	Schlepper / 4000-4894	4220	0						
420036N	Case International IHC	Schlepper / 4000-4894	4230	0						
422032N	Case International IHC	Schlepper / 4000-4894	4230	0	295	275	18			
420036N	Case International IHC	Schlepper / 4000-4894	4240	0						
422032N	Case International IHC	Schlepper / 4000-4894	4430	0	295	275	18			
420029N	Case International IHC	Schlepper / 5088-5488	5120	0						
420027N	Case International IHC	Schlepper / 5088-5488	5120	0	350	330	38		ohne Trockner	127270A1 1335209C1
420029N	Case International IHC	Schlepper / 5088-5488	5130	0						
420027N	Case International IHC	Schlepper / 5088-5488	5130	0	350	330	38		ohne Trockner	127270A1 1335209C1
420029N	Case International IHC	Schlepper / 5088-5488	5140	0						
420027N	Case International IHC	Schlepper / 5088-5488	5140	0	350	330	38		ohne Trockner	127270A1 1335209C1
420029N	Case International IHC	Schlepper / 5088-5488	5150	0						
420027N	Case International IHC	Schlepper / 5088-5488	5150	0	350	330	38		ohne Trockner	127270A1 1335209C1
420042N	Case International IHC	Schlepper / CS	100	0	320	520	70			
420042N	Case International IHC	Schlepper / CS	110	0	320	520	70			
420042N	Case International IHC	Schlepper / CS	120	0	320	520	70			

Dasis Nr.	Hersteller	Modell	Typ	KW	Netzlänge [mm]	Netzbreite [mm]	Netztiefe [mm]	Netzmaße	mit / ohne Trockner	für OE-Nummer
420042N	Case International IHC	Schlepper / CS	130	0	320	520	70			
420042N	Case International IHC	Schlepper / CS	150	0	320	520	70			
420023N	Case International IHC	Schlepper / CVX	V120	0	520	400	32		ohne Trockner	
420023N	Case International IHC	Schlepper / CVX	V130	0	520	400	32		ohne Trockner	
420023N	Case International IHC	Schlepper / CVX	V150	0	520	400	32		ohne Trockner	
420023N	Case International IHC	Schlepper / CVX	V170	0	520	400	32		ohne Trockner	
420023N	Case International IHC	Schlepper / CVX	V1135	0	520	400	32		ohne Trockner	
420023N	Case International IHC	Schlepper / CVX	V1145	0	520	400	32		ohne Trockner	
420023N	Case International IHC	Schlepper / CVX	V1155	0	520	400	32		ohne Trockner	
420023N	Case International IHC	Schlepper / CVX	V1170	0	520	400	32		ohne Trockner	
420023N	Case International IHC	Schlepper / CVX	V1190	0	520	400	32		ohne Trockner	
420026N	Case International IHC	Schlepper / CX	50	0	49	28	5			
420026N	Case International IHC	Schlepper / CX	60	0	49	28	5			
420026N	Case International IHC	Schlepper / CX	70	0	49	28	5			
420026N	Case International IHC	Schlepper / CX	80	0	49	28	5			
420026N	Case International IHC	Schlepper / CX	90	0	49	28	5			
420026N	Case International IHC	Schlepper / CX	100	0	49	28	5			
442008N	Case International IHC	Schlepper / JX	70 Räder 2	0	315	391	22			
442007N	Case International IHC	Schlepper / JX	75 Räder 3	0	351	391	22			
442008N	Case International IHC	Schlepper / JX	80 Räder 2	0	315	391	22			
442007N	Case International IHC	Schlepper / JX	80 Räder 3	0	351	391	22			
442007N	Case International IHC	Schlepper / JX	85 Räder 3	0	351	391	22			
442008N	Case International IHC	Schlepper / JX	90 Räder 2	0	315	391	22			
442007N	Case International IHC	Schlepper / JX	90 Räder 3	0	351	391	22			
442008N	Case International IHC	Schlepper / JX	95 Räder 2	0	315	391	22			
442008N	Case International IHC	Schlepper / JX	110	0	315	391	22			
422040N	Case International IHC	Schlepper / JX	1070U	0	476	533	44		ohne Trockner	47132050



Dasis Nr.	Hersteller	Modell	Typ	KW	Netzlänge [mm]	Netzbreite [mm]	Netztiefe [mm]	Netzmaße	mit / ohne Trockner	für OE-Nummer
422040N	Case International IHC	Schlepper / JX	1080U	0	476	533	44		ohne Trockner	47132050
422040N	Case International IHC	Schlepper / JX	1090U	0	476	533	44		ohne Trockner	47132050
422040N	Case International IHC	Schlepper / JX	1100U	0	476	533	44		ohne Trockner	47132050
422012N	Case International IHC	Schlepper / JXU	J70	0	490	406	51		ohne Trockner	
422012N	Case International IHC	Schlepper / JXU	J80	0	490	406	51		ohne Trockner	
422012N	Case International IHC	Schlepper / JXU	J90	0	490	406	51		ohne Trockner	
422012N	Case International IHC	Schlepper / JXU	J100	0	490	406	51		ohne Trockner	
422038N	Case International IHC	Schlepper / Maxxum	115 Multicontroller	0	400	525	26		ohne Trockner	
422038N	Case International IHC	Schlepper / Maxxum	140 Multicontroller	0	400	525	26		ohne Trockner	
420053N	Case International IHC	Schlepper / MX	100	0	630	600	160			
420053N	Case International IHC	Schlepper / MX	110	0	630	600	160			
420053N	Case International IHC	Schlepper / MX	120	0	630	600	160			
420053N	Case International IHC	Schlepper / MX	135	0	630	600	160			
420053N	Case International IHC	Schlepper / MX	150	0	630	600	160			
420053N	Case International IHC	Schlepper / MX	170	0	630	600	160			
420053N	Case International IHC	Schlepper / MX	180	0	630	600	160			
420053N	Case International IHC	Schlepper / MX	200	0	630	600	160			
420053N	Case International IHC	Schlepper / MX	220	0	630	600	160			
420053N	Case International IHC	Schlepper / MX	240	0	630	600	160			
420053N	Case International IHC	Schlepper / MX	270	0	630	600	160			
420026N	Case International IHC	Schlepper / MXC	80	0	49	28	5			
420026N	Case International IHC	Schlepper / MXC	90	0	49	28	5			
420026N	Case International IHC	Schlepper / MXC	100	0	49	28	5			
420008N	Case International IHC	Schlepper / MXM	120	0						82023592 82033407
420008N	Case International IHC	Schlepper / MXM	130	0						82023592 82033407
420008N	Case International IHC	Schlepper / MXM	140	0						82023592 82033407
420008N	Case International IHC	Schlepper / MXM	155	0						82023592 82033407

Dasis Nr.	Hersteller	Modell	Typ	KW	Netzlänge [mm]	Netzbreite [mm]	Netztiefe [mm]	Netzmaße	mit / ohne Trockner	für OE-Nummer
420008N	Case International IHC	Schlepper / MXM	175	0						82023592 82033407
420008N	Case International IHC	Schlepper / MXM	190	0						82023592 82033407
420007N	Case International IHC	Schlepper / MXU	100	0	502	305	66		ohne Trockner	
420007N	Case International IHC	Schlepper / MXU	110	0	502	305	66		ohne Trockner	
420007N	Case International IHC	Schlepper / MXU	115	0	502	305	66		ohne Trockner	
420007N	Case International IHC	Schlepper / MXU	125	0	502	305	66		ohne Trockner	
420007N	Case International IHC	Schlepper / MXU	130	0	502	305	66		ohne Trockner	
420007N	Case International IHC	Schlepper / MXU	135	0	502	305	66		ohne Trockner	
422038N	Case International IHC	Schlepper / Puma	115	0	400	525	26		ohne Trockner	
422038N	Case International IHC	Schlepper / Puma	125	0	400	525	26		ohne Trockner	
422038N	Case International IHC	Schlepper / Puma	140	0	400	525	26		ohne Trockner	
422038N	Case International IHC	Schlepper / Puma	155	0	400	525	26		ohne Trockner	
452006N	Case International IHC	Schlepper / Puma CVT Serie	130	0	397	524	22		ohne Trockner	
452006N	Case International IHC	Schlepper / Puma CVT Serie	145	0	397	524	22		ohne Trockner	
452006N	Case International IHC	Schlepper / Puma CVT Serie	160	0	397	524	22		ohne Trockner	
452006N	Case International IHC	Schlepper / Puma CVX Serie	130	0	397	524	22		ohne Trockner	
452006N	Case International IHC	Schlepper / Puma CVX Serie	145	0	397	524	22		ohne Trockner	
452007N	Case International IHC	Schlepper / Quadtrac	370	0	790	290	70		ohne Trockner	
452007N	Case International IHC	Schlepper / Quadtrac	450	0	790	290	70		ohne Trockner	
452007N	Case International IHC	Schlepper / Steiger 300-600	350	0	790	290	70		ohne Trockner	
452007N	Case International IHC	Schlepper / Steiger 300-600	370	0	790	290	70		ohne Trockner	
452007N	Case International IHC	Schlepper / Steiger 300-600	400	0	790	290	70		ohne Trockner	

Dasis Nr.	Hersteller	Modell	Typ	KW	Netzlänge [mm]	Netzbreite [mm]	Netztiefe [mm]	Netzmaße	mit / ohne Trockner	für OE-Nummer
452007N	Case International IHC	Schlepper / Steiger 300-600	420	0	790	290	70		ohne Trockner	
452007N	Case International IHC	Schlepper / Steiger 300-600	450	0	790	290	70		ohne Trockner	
452007N	Case International IHC	Schlepper / Steiger 300-600	470	0	790	290	70		ohne Trockner	
452001N	Caterpillar	Bagger 360 Grad / 300 Serie	307D	0	521	350	16		ohne Trockner	2358880 2457749
422083N	Caterpillar	Bagger 360 Grad / 300 Serie	307D	0	521	356	16		ohne Trockner	2457749
452001N	Caterpillar	Bagger 360 Grad / 300 Serie	307E	0	521	350	16		ohne Trockner	2358880 2457749
452001N	Caterpillar	Bagger 360 Grad / 300 Serie	308E	0	521	350	16		ohne Trockner	2358880 2457749
452001N	Caterpillar	Bagger 360 Grad / 300 Serie	311D	0	521	350	16		ohne Trockner	2358880 2457749
422083N	Caterpillar	Bagger 360 Grad / 300 Serie	311D	0	521	356	16		ohne Trockner	2457749
452001N	Caterpillar	Bagger 360 Grad / 300 Serie	312D	0	521	350	16		ohne Trockner	2358880 2457749
422083N	Caterpillar	Bagger 360 Grad / 300 Serie	312D	0	521	356	16		ohne Trockner	2457749
452001N	Caterpillar	Bagger 360 Grad / 300 Serie	313D	0	521	350	16		ohne Trockner	2358880 2457749
422083N	Caterpillar	Bagger 360 Grad / 300 Serie	313D	0	521	356	16		ohne Trockner	2457749
452001N	Caterpillar	Bagger 360 Grad / 300 Serie	315D	0	521	350	16		ohne Trockner	2358880 2457749
422083N	Caterpillar	Bagger 360 Grad / 300 Serie	315D	0	521	356	16		ohne Trockner	2457749
452001N	Caterpillar	Bagger 360 Grad / 300 Serie	318D	0	521	350	16		ohne Trockner	2358880 2457749
422083N	Caterpillar	Bagger 360 Grad / 300 Serie	318D	0	521	356	16		ohne Trockner	2457749
452001N	Caterpillar	Bagger 360 Grad / 300 Serie	319D	0	521	350	16		ohne Trockner	2358880 2457749
422083N	Caterpillar	Bagger 360 Grad / 300 Serie	319D	0	521	356	16		ohne Trockner	2457749
422097N	Caterpillar	Bagger 360 Grad / 300 Serie	320C	0	406	368	19		ohne Trockner	2457866
422097N	Caterpillar	Bagger 360 Grad / 300 Serie	320CL	0	406	368	19		ohne Trockner	2457866

Dasis Nr.	Hersteller	Modell	Typ	KW	Netzlänge [mm]	Netzbreite [mm]	Netztiefe [mm]	Netzmaße	mit / ohne Trockner	für OE-Nummer
422083N	Caterpillar	Bagger 360 Grad / 300 Serie	320D	0	521	356	16		ohne Trockner	2457749
422097N	Caterpillar	Bagger 360 Grad / 300 Serie	322C	0	406	368	19		ohne Trockner	2457866
422083N	Caterpillar	Bagger 360 Grad / 300 Serie	323D	0	521	356	16		ohne Trockner	2457749
422098N	Caterpillar	Bagger 360 Grad / 300 Serie	324D	0	406	368	19		ohne Trockner	2457911
422098N	Caterpillar	Bagger 360 Grad / 300 Serie	324D FM	0	406	368	19		ohne Trockner	2457911
422098N	Caterpillar	Bagger 360 Grad / 300 Serie	324DL	0	406	368	19		ohne Trockner	2457911
452022N	Caterpillar	Bagger 360 Grad / 300 Serie	324E	0	381	418	16			3639500
452022N	Caterpillar	Bagger 360 Grad / 300 Serie	324E L	0	381	418	16			3639500
452022N	Caterpillar	Bagger 360 Grad / 300 Serie	324E LN	0	381	418	16			3639500
422098N	Caterpillar	Bagger 360 Grad / 300 Serie	325D	0	406	368	19		ohne Trockner	2457911
422098N	Caterpillar	Bagger 360 Grad / 300 Serie	325DL	0	406	368	19		ohne Trockner	2457911
422098N	Caterpillar	Bagger 360 Grad / 300 Serie	326DL	0	406	368	19		ohne Trockner	2457911
452022N	Caterpillar	Bagger 360 Grad / 300 Serie	326F L	0	381	418	16			3639500
422098N	Caterpillar	Bagger 360 Grad / 300 Serie	329D	0	406	368	19		ohne Trockner	2457911
422098N	Caterpillar	Bagger 360 Grad / 300 Serie	329DL	0	406	368	19		ohne Trockner	2457911
422098N	Caterpillar	Bagger 360 Grad / 300 Serie	329D LN	0	406	368	19		ohne Trockner	2457911
452022N	Caterpillar	Bagger 360 Grad / 300 Serie	329E L	0	381	418	16			3639500
422098N	Caterpillar	Bagger 360 Grad / 300 Serie	330D	0	406	368	19		ohne Trockner	2457911
422098N	Caterpillar	Bagger 360 Grad / 300 Serie	330D FM	0	406	368	19		ohne Trockner	2457911
422098N	Caterpillar	Bagger 360 Grad / 300 Serie	330DL	0	406	368	19		ohne Trockner	2457911
422097N	Caterpillar	Bagger 360 Grad / 300 Serie	336D	0	406	368	19		ohne Trockner	2457866

Dasis Nr.	Hersteller	Modell	Typ	KW	Netzlänge [mm]	Netzbreite [mm]	Netztiefe [mm]	Netzmaße	mit / ohne Trockner	für OE-Nummer
422098N	Caterpillar	Bagger 360 Grad / 300 Serie	336D	0	406	368	19		ohne Trockner	2457911
422097N	Caterpillar	Bagger 360 Grad / 300 Serie	336DL	0	406	368	19		ohne Trockner	2457866
422098N	Caterpillar	Bagger 360 Grad / 300 Serie	336DL	0	406	368	19		ohne Trockner	2457911
452022N	Caterpillar	Bagger 360 Grad / 300 Serie	336E H	0	381	418	16			3639500
452022N	Caterpillar	Bagger 360 Grad / 300 Serie	336E L	0	381	418	16			3639500
452022N	Caterpillar	Bagger 360 Grad / 300 Serie	336E LH	0	381	418	16			3639500
452022N	Caterpillar	Bagger 360 Grad / 300 Serie	336E LNH	0	381	418	16			3639500
422098N	Caterpillar	Bagger 360 Grad / 300 Serie	340DL	0	406	368	19		ohne Trockner	2457911
422097N	Caterpillar	Bagger 360 Grad / 300 Serie	345C	0	406	368	19		ohne Trockner	2457866
422097N	Caterpillar	Bagger 360 Grad / 300 Serie	345CL	0	406	368	19		ohne Trockner	2457866
422097N	Caterpillar	Bagger 360 Grad / 300 Serie	345D	0	406	368	19		ohne Trockner	2457866
422097N	Caterpillar	Bagger 360 Grad / 300 Serie	345DL	0	406	368	19		ohne Trockner	2457866
422097N	Caterpillar	Bagger 360 Grad / 300 Serie	349D	0	406	368	19		ohne Trockner	2457866
422097N	Caterpillar	Bagger 360 Grad / 300 Serie	349DL	0	406	368	19		ohne Trockner	2457866
452022N	Caterpillar	Bagger 360 Grad / 300 Serie	349E L	0	381	418	16			3639500
422097N	Caterpillar	Bagger 360 Grad / 300 Serie	374DL	0	406	368	19		ohne Trockner	2457866
452001N	Caterpillar	Bagger 360 Grad / 300 Serie	385C	0	521	350	16		ohne Trockner	2358880 2457749
422083N	Caterpillar	Bagger 360 Grad / 300 Serie	385C	0	521	356	16		ohne Trockner	2457749
452001N	Caterpillar	Bagger 360 Grad / 300 Serie	390D	0	521	350	16		ohne Trockner	2358880 2457749
422083N	Caterpillar	Bagger 360 Grad / 300 Serie	390D	0	521	356	16		ohne Trockner	2457749
452008N	Caterpillar	Baggerlader / 400C	436	0	508	492	50		ohne Trockner	

Dasis Nr.	Hersteller	Modell	Typ	KW	Netzlänge [mm]	Netzbreite [mm]	Netztiefe [mm]	Netzmaße	mit / ohne Trockner	für OE-Nummer
452008N	Caterpillar	Baggerlader / 400C	438	0	508	492	50		ohne Trockner	
452008N	Caterpillar	Baggerlader / 400D	420	0	508	492	50		ohne Trockner	
452008N	Caterpillar	Baggerlader / 400D	428	0	508	492	50		ohne Trockner	
452008N	Caterpillar	Baggerlader / 400D	430	0	508	492	50		ohne Trockner	
452008N	Caterpillar	Baggerlader / 400D	442	0	508	492	50		ohne Trockner	
422099N	Caterpillar	Baggerlader / 400E	416E	0	495	648	25		ohne Trockner	3006792 3538584
422099N	Caterpillar	Baggerlader / 400E	420E	0	495	648	25		ohne Trockner	3006792 3538584
422099N	Caterpillar	Baggerlader / 400E	422E	0	495	648	25		ohne Trockner	3006792 3538584
422099N	Caterpillar	Baggerlader / 400E	428E	0	495	648	25		ohne Trockner	3006792 3538584
422099N	Caterpillar	Baggerlader / 400E	430E	0	495	648	25		ohne Trockner	3006792 3538584
422099N	Caterpillar	Baggerlader / 400E	432E	0	495	648	25		ohne Trockner	3006792 3538584
422099N	Caterpillar	Baggerlader / 400E	434E	0	495	648	25		ohne Trockner	3006792 3538584
422099N	Caterpillar	Baggerlader / 400E	442E	0	495	648	25		ohne Trockner	3006792 3538584
422099N	Caterpillar	Baggerlader / 400E	444E	0	495	648	25		ohne Trockner	3006792 3538584
422099N	Caterpillar	Baggerlader / 400E	450E	0	495	648	25		ohne Trockner	3006792 3538584
422099N	Caterpillar	Baggerlader / 400F	428F	0	495	648	25		ohne Trockner	3006792 3538584
422099N	Caterpillar	Baggerlader / 400F	430F	0	495	648	25		ohne Trockner	3006792 3538584
422099N	Caterpillar	Baggerlader / 400F	432F	0	495	648	25		ohne Trockner	3006792 3538584
422099N	Caterpillar	Baggerlader / 400F	434F	0	495	648	25		ohne Trockner	3006792 3538584
422099N	Caterpillar	Baggerlader / 400F	444F	0	495	648	25		ohne Trockner	3006792 3538584
422099N	Caterpillar	Baggerlader / 400F	450F	0	495	648	25		ohne Trockner	3006792 3538584

Dasis Nr.	Hersteller	Modell	Typ	KW	Netzlänge [mm]	Netzbreite [mm]	Netztiefe [mm]	Netzmaße	mit / ohne Trockner	für OE-Nummer
452012N	Caterpillar	Kompaktlader / 200B Serie	236B	0	498	248	26			218-6807
452012N	Caterpillar	Kompaktlader / 200B Serie	246B	0	498	248	26			218-6807
452012N	Caterpillar	Kompaktlader / 200B Serie	247B	0	498	248	26			218-6807
452012N	Caterpillar	Kompaktlader / 200B Serie	248B	0	498	248	26			218-6807
452012N	Caterpillar	Kompaktlader / 200B Serie	252B	0	498	248	26			218-6807
452012N	Caterpillar	Kompaktlader / 200B Serie	257B	0	498	248	26			218-6807
452012N	Caterpillar	Kompaktlader / 200B Serie	262B	0	498	248	26			218-6807
452012N	Caterpillar	Kompaktlader / 200B Serie	267B	0	498	248	26			218-6807
452012N	Caterpillar	Kompaktlader / 200B Serie	268B	0	498	248	26			218-6807
452012N	Caterpillar	Kompaktlader / 200B Serie	277B	0	498	248	26			218-6807
452012N	Caterpillar	Kompaktlader / 200B Serie	287B	0	498	248	26			218-6807
422029N	Caterpillar	Motorgrader / H	12	0						
422029N	Caterpillar	Motorgrader / H	14	0						
422029N	Caterpillar	Motorgrader / H	16	0						
422029N	Caterpillar	Motorgrader / H	120	0						
422029N	Caterpillar	Motorgrader / H	135	0						
422029N	Caterpillar	Motorgrader / H	140	0						
422029N	Caterpillar	Motorgrader / H	143	0						
422029N	Caterpillar	Motorgrader / H	163	0						
420056N	Caterpillar	Raupen Dozer / 900	953	0						
420056N	Caterpillar	Raupen Dozer / 900	955	0						
420056N	Caterpillar	Raupen Dozer / 900	996	0						
420056N	Caterpillar	Raupen Dozer / D	6R	0						
420056N	Caterpillar	Raupen Dozer / D	9R	0						
420047N	Caterpillar	Raupen Schlepper / Challenger	65E	0						

Dasis Nr.	Hersteller	Modell	Typ	KW	Netzlänge [mm]	Netzbreite [mm]	Netztiefe [mm]	Netzmaße	mit / ohne Trockner	für OE-Nummer
420047N	Caterpillar	Raupen Schlepper / Challenger	75E	0						
420047N	Caterpillar	Raupen Schlepper / Challenger	85E	0						
420047N	Caterpillar	Raupen Schlepper / Challenger	95E	0						
422002N	Claas	Feldhäcksler / Jaguar	685	0	610	500	55		ohne Trockner	
422002N	Claas	Feldhäcksler / Jaguar	690	0	610	500	55		ohne Trockner	
422002N	Claas	Feldhäcksler / Jaguar	695	0	610	500	55		ohne Trockner	
422008N	Claas	Mähdrescher / Dominator 6	56	0	680	250	60			
422008N	Claas	Mähdrescher / Dominator 6	66	0	680	250	60			
422008N	Claas	Mähdrescher / Dominator 6	76	0	680	250	60			
422008N	Claas	Mähdrescher / Dominator 6	86	0	680	250	60			
422008N	Claas	Mähdrescher / Dominator 6	96	0	680	250	60			
422008N	Claas	Mähdrescher / Dominator 6	106	0	680	250	60			
422008N	Claas	Mähdrescher / Dominator 6	116	0	680	250	60			
422088N	Claas	Schlepper / Ares 500	546 RX/RZ	0	440	440	50	440x440x50		7700059987
422088N	Claas	Schlepper / Ares 500	556 RX/RZ	0	440	440	50	440x440x50		7700059987
422088N	Claas	Schlepper / Ares 500	566 RX/RZ	0	440	440	50	440x440x50		7700059987
422088N	Claas	Schlepper / Ares 600	616 RC	0	440	440	50	440x440x50		7700059987
422088N	Claas	Schlepper / Ares 600	656 RC	0	440	440	50	440x440x50		7700059987
422088N	Claas	Schlepper / Ares 600	656 RZ	0	440	440	50	440x440x50		7700059987
422088N	Claas	Schlepper / Ares 600	696 RZ	0	440	440	50	440x440x50		7700059987
422021N	Claas	Schlepper / Axos	310	55	435	257	85			
422021N	Claas	Schlepper / Axos	320	64	435	257	85			
422021N	Claas	Schlepper / Axos	340	75	435	257	85			
420004N	Claas	Targo	40	0						
420004N	Claas	Targo	50	0						



Dasis Nr.	Hersteller	Modell	Typ	KW	Netzlänge [mm]	Netzbreite [mm]	Netztiefe [mm]	Netzmaße	mit / ohne Trockner	für OE-Nummer
420004N	Claas	Targo	K50	0						
420004N	Claas	Targo	K60	0						
420004N	Claas	Targo	K70	0						
452021N	Claas	Teleskoplader / Ranger	945 GX	0	610	285	30		ohne Trockner	3164330
422100N	Claas	Teleskoplader / Scorpion	6030	0	425	430	40			0013004300
422100N	Claas	Teleskoplader / Scorpion	6040	0	425	430	40			0013004300
422100N	Claas	Teleskoplader / Scorpion	7030	0	425	430	40			0013004300
422100N	Claas	Teleskoplader / Scorpion	7040	0	425	430	40			0013004300
422100N	Claas	Teleskoplader / Scorpion	7045	0	425	430	40			0013004300
422100N	Claas	Teleskoplader / Scorpion	9040	0	425	430	40			0013004300
422101N	Daewoo / Doosan / Moxxy	Bagger / Solar	55	0	375	356	19		ohne Trockner	25201002 52000003
422101N	Daewoo / Doosan / Moxxy	Bagger / Solar	55W-V	0	375	356	19		ohne Trockner	25201002 52000003
420034N	Deutz	Mähdrescher / Agrovector	266	0						
420034N	Deutz	Mähdrescher / Agrovector	307	0						
420049N	Deutz	Schlepper / AgroStar	4.61	0	462	357	44		ohne Trockner	4321436 4337405
420049N	Deutz	Schlepper / AgroStar	4.71	0	462	357	44		ohne Trockner	4321436 4337405
420049N	Deutz	Schlepper / AgroStar	6.11	0	462	357	44		ohne Trockner	4321436 4337405
420049N	Deutz	Schlepper / AgroStar	6.21	0	462	357	44		ohne Trockner	4321436 4337405
420049N	Deutz	Schlepper / AgroStar	6.31	0	462	357	44		ohne Trockner	4321436 4337405
420049N	Deutz	Schlepper / AgroStar	6.61	0	462	357	44		ohne Trockner	4321436 4337405
420054N	Deutz	Schlepper / AgroStar DX	4.61	0	435	350	30			
420054N	Deutz	Schlepper / AgroStar DX	4.71	0	435	350	30			
420054N	Deutz	Schlepper / AgroStar DX	6.11	0	435	350	30			
420054N	Deutz	Schlepper / AgroStar DX	6.21	0	435	350	30			
420054N	Deutz	Schlepper / AgroStar DX	6.31	0	435	350	30			
420054N	Deutz	Schlepper / AgroStar DX	6.61	0	435	350	30			

Dasis Nr.	Hersteller	Modell	Typ	KW	Netzlänge [mm]	Netzbreite [mm]	Netztiefe [mm]	Netzmaße	mit / ohne Trockner	für OE-Nummer
420054N	Deutz	Schlepper / AgroStar Freisicht S.	4.68	0	435	350	30			
420054N	Deutz	Schlepper / AgroStar Freisicht S.	4.78	0	435	350	30			
420054N	Deutz	Schlepper / AgroStar Freisicht S.	6.08	0	435	350	30			
420054N	Deutz	Schlepper / AgroStar Freisicht S.	6.28	0	435	350	30			
420054N	Deutz	Schlepper / AgroStar Freisicht S.	6.38	0	435	350	30			
420032N	Deutz	Schlepper / Agrottron mk1	4.70	0						
420032N	Deutz	Schlepper / Agrottron mk1	4.80	0						
420032N	Deutz	Schlepper / Agrottron mk1	4.85	0						
420032N	Deutz	Schlepper / Agrottron mk1	4.90	0						
420032N	Deutz	Schlepper / Agrottron mk1	4.95	0						
420032N	Deutz	Schlepper / Agrottron mk1	6.00	0						
420032N	Deutz	Schlepper / Agrottron mk1	6.01	0						
420032N	Deutz	Schlepper / Agrottron mk1	6.05	0						
420032N	Deutz	Schlepper / Agrottron mk1	6.15	0						
420032N	Deutz	Schlepper / Agrottron mk1	6.20	0						
420032N	Deutz	Schlepper / Agrottron mk1	6.30	0						
420032N	Deutz	Schlepper / Agrottron mk1	6.45	0						
420052N	Deutz	Schlepper / Agrottron mk3	80	0	420	275	90			
420052N	Deutz	Schlepper / Agrottron mk3	85	0	420	275	90			
420052N	Deutz	Schlepper / Agrottron mk3	90	0	420	275	90			
420052N	Deutz	Schlepper / Agrottron mk3	100	0	420	275	90			

Dasis Nr.	Hersteller	Modell	Typ	KW	Netzlänge [mm]	Netzbreite [mm]	Netztiefe [mm]	Netzmaße	mit / ohne Trockner	für OE-Nummer
420052N	Deutz	Schlepper / Agrottron mk3	105	0	420	275	90			
420052N	Deutz	Schlepper / Agrottron mk3	106	0	420	275	90			
420052N	Deutz	Schlepper / Agrottron mk3	110	0	420	275	90			
420052N	Deutz	Schlepper / Agrottron mk3	115	0	420	275	90			
420052N	Deutz	Schlepper / Agrottron mk3	120	0	420	275	90			
420052N	Deutz	Schlepper / Agrottron mk3	135	0	420	275	90			
420052N	Deutz	Schlepper / Agrottron mk3	150	0	420	275	90			
420052N	Deutz	Schlepper / Agrottron mk3	160	0	420	275	90			
420052N	Deutz	Schlepper / Agrottron mk3	175	0	420	275	90			
420052N	Deutz	Schlepper / Agrottron mk3	200	0	420	275	90			
420055N	Deutz	Schlepper / Agrottron TTV	1130	0	415	490	60			
420055N	Deutz	Schlepper / Agrottron TTV	1140	0	415	490	60			
420055N	Deutz	Schlepper / Agrottron TTV	1160	0	415	490	60			
422090N	Fendt	Mähdrescher / Forage / Katana	85	0						H842550061100
422015N	Fendt	Schlepper / Farmer 200	206	0	780	210	125			65260001
422015N	Fendt	Schlepper / Farmer 200	207	0	780	210	125			65260001
422015N	Fendt	Schlepper / Farmer 200	208	0	780	210	125			65260001
422015N	Fendt	Schlepper / Farmer 200	209	0	780	210	125			65260001
452003N	Fendt	Schlepper / Farmer 200	240	0					ohne Trockner	
452003N	Fendt	Schlepper / Farmer 200	250	0					ohne Trockner	
452003N	Fendt	Schlepper / Farmer 200	250K	0					ohne Trockner	
452003N	Fendt	Schlepper / Farmer 200	250KA	0					ohne Trockner	
452003N	Fendt	Schlepper / Farmer 200	250LE	0					ohne Trockner	
452003N	Fendt	Schlepper / Farmer 200	250S	0					ohne Trockner	

Dasis Nr.	Hersteller	Modell	Typ	KW	Netzlänge [mm]	Netzbreite [mm]	Netztiefe [mm]	Netzmaße	mit / ohne Trockner	für OE-Nummer
452003N	Fendt	Schlepper / Farmer 200	250SA	0					ohne Trockner	
452003N	Fendt	Schlepper / Farmer 200	250V	0					ohne Trockner	
452003N	Fendt	Schlepper / Farmer 200	250VA	0					ohne Trockner	
452003N	Fendt	Schlepper / Farmer 200	260	0					ohne Trockner	
452003N	Fendt	Schlepper / Farmer 200	260P	0					ohne Trockner	
452003N	Fendt	Schlepper / Farmer 200	260PA	0					ohne Trockner	
452003N	Fendt	Schlepper / Farmer 200	260S	0					ohne Trockner	
452003N	Fendt	Schlepper / Farmer 200	260SA	0					ohne Trockner	
452003N	Fendt	Schlepper / Farmer 200	260V	0					ohne Trockner	
452003N	Fendt	Schlepper / Farmer 200	260VA	0					ohne Trockner	
452003N	Fendt	Schlepper / Farmer 200	270	0					ohne Trockner	
452003N	Fendt	Schlepper / Farmer 200	270P	0					ohne Trockner	
452003N	Fendt	Schlepper / Farmer 200	270PA	0					ohne Trockner	
452003N	Fendt	Schlepper / Farmer 200	270V	0					ohne Trockner	
452003N	Fendt	Schlepper / Farmer 200	270VA	0					ohne Trockner	
452003N	Fendt	Schlepper / Farmer 200	275	0					ohne Trockner	
452003N	Fendt	Schlepper / Farmer 200	275S	0					ohne Trockner	
452003N	Fendt	Schlepper / Farmer 200	275SA	0					ohne Trockner	
452003N	Fendt	Schlepper / Farmer 200	275V	0					ohne Trockner	
452003N	Fendt	Schlepper / Farmer 200	275VA	0					ohne Trockner	
452003N	Fendt	Schlepper / Farmer 200	280	0					ohne Trockner	

Dasis Nr.	Hersteller	Modell	Typ	KW	Netzlänge [mm]	Netzbreite [mm]	Netztiefe [mm]	Netzmaße	mit / ohne Trockner	für OE-Nummer
452003N	Fendt	Schlepper / Farmer 200	280P	0					ohne Trockner	
452003N	Fendt	Schlepper / Farmer 200	280PA	0					ohne Trockner	
452003N	Fendt	Schlepper / Farmer 200	280S	0					ohne Trockner	
452003N	Fendt	Schlepper / Farmer 200	280SA	0					ohne Trockner	
452003N	Fendt	Schlepper / Farmer 200	280V	0					ohne Trockner	
452003N	Fendt	Schlepper / Farmer 200	280VA	0					ohne Trockner	
452016N	Fendt	Schlepper / Farmer 200 V/F/P Serie	208	0	690	255	64		ohne Trockner	F260550010130
452016N	Fendt	Schlepper / Farmer 200 V/F/P Serie	209	0	690	255	64		ohne Trockner	F260550010130
452016N	Fendt	Schlepper / Farmer 200 V/F/P Serie	210	0	690	255	64		ohne Trockner	F260550010130
452016N	Fendt	Schlepper / Farmer 200 V/F/P Serie	211	0	690	255	64		ohne Trockner	F260550010130
420041N	Fendt	Schlepper / Farmer 300	303LS	0	405	388	25			
420041N	Fendt	Schlepper / Farmer 300	303LSA	0	405	388	25			
420041N	Fendt	Schlepper / Farmer 300	304LS	0	405	388	25			
420041N	Fendt	Schlepper / Farmer 300	304LSA	0	405	388	25			
420041N	Fendt	Schlepper / Farmer 300	305LS	0	405	388	25			
420041N	Fendt	Schlepper / Farmer 300	305LSA	0	405	388	25			
420041N	Fendt	Schlepper / Farmer 300	306LS	0	405	388	25			
420041N	Fendt	Schlepper / Farmer 300	306LSA	0	405	388	25			
422017N	Fendt	Schlepper / Farmer 300	307	0	338	437	85			
420041N	Fendt	Schlepper / Farmer 300	307	0	405	388	25			
420041N	Fendt	Schlepper / Farmer 300	307LS	0	405	388	25			
420041N	Fendt	Schlepper / Farmer 300	307LSA	0	405	388	25			
420041N	Fendt	Schlepper / Farmer 300	307LSE	0	405	388	25			
422017N	Fendt	Schlepper / Farmer 300	308	0	338	437	85			
420041N	Fendt	Schlepper / Farmer 300	308	0	405	388	25			
420041N	Fendt	Schlepper / Farmer 300	308LS	0	405	388	25			
420041N	Fendt	Schlepper / Farmer 300	308LSA	0	405	388	25			

Dasis Nr.	Hersteller	Modell	Typ	KW	Netzlänge [mm]	Netzbreite [mm]	Netztiefe [mm]	Netzmaße	mit / ohne Trockner	für OE-Nummer
420041N	Fendt	Schlepper / Farmer 300	308LSE	0	405	388	25			
422017N	Fendt	Schlepper / Farmer 300	309	0	338	437	85			
420041N	Fendt	Schlepper / Farmer 300	309	0	405	388	25			
422017N	Fendt	Schlepper / Farmer 300	309LS	0	338	437	85			
420041N	Fendt	Schlepper / Farmer 300	309LS	0	405	388	25			
422017N	Fendt	Schlepper / Farmer 300	309LSA	0	338	437	85			
420041N	Fendt	Schlepper / Farmer 300	309LSA	0	405	388	25			
422017N	Fendt	Schlepper / Farmer 300	309LSE	0	338	437	85			
420041N	Fendt	Schlepper / Farmer 300	309LSE	0	405	388	25			
420041N	Fendt	Schlepper / Farmer 300	310LSA	0	405	388	25			
420041N	Fendt	Schlepper / Farmer 300	310LSE	0	405	388	25			
420041N	Fendt	Schlepper / Farmer 300	311LSA	0	405	388	25			
420041N	Fendt	Schlepper / Farmer 300	311LSE	0	405	388	25			
420041N	Fendt	Schlepper / Farmer 300	312LSA	0	405	388	25			
420041N	Fendt	Schlepper / Farmer 300	312LSE	0	405	388	25			
420025N	Fendt	Schlepper / Farmer 400	409	0	340	335	82			
420025N	Fendt	Schlepper / Farmer 400	410	0	340	335	82			
420025N	Fendt	Schlepper / Farmer 400	411	0	340	335	82			
420025N	Fendt	Schlepper / Farmer 400	412	0	340	335	82			
420041N	Fendt	Schlepper / Favorit 500	509	0	405	388	25			
420041N	Fendt	Schlepper / Favorit 500	510	0	405	388	25			
420041N	Fendt	Schlepper / Favorit 500	511	0	405	388	25			
420041N	Fendt	Schlepper / Favorit 500	512	0	405	388	25			
420041N	Fendt	Schlepper / Favorit 500	514	0	405	388	25			
420041N	Fendt	Schlepper / Favorit 500	515	0	405	388	25			
420041N	Fendt	Schlepper / Favorit 600	611LS	0	405	388	25			
420041N	Fendt	Schlepper / Favorit 600	611LSA	0	405	388	25			
420041N	Fendt	Schlepper / Favorit 600	611S	0	405	388	25			
420041N	Fendt	Schlepper / Favorit 600	611SA	0	405	388	25			
420041N	Fendt	Schlepper / Favorit 600	612LSA	0	405	388	25			
420041N	Fendt	Schlepper / Favorit 600	612SA	0	405	388	25			

Dasis Nr.	Hersteller	Modell	Typ	KW	Netzlänge [mm]	Netzbreite [mm]	Netztiefe [mm]	Netzmaße	mit / ohne Trockner	für OE-Nummer
420041N	Fendt	Schlepper / Favorit 600	614LSA	0	405	388	25			
420041N	Fendt	Schlepper / Favorit 600	614SA	0	405	388	25			
420041N	Fendt	Schlepper / Favorit 600	615LSA	0	405	388	25			
420041N	Fendt	Schlepper / Favorit 600	615SA	0	405	388	25			
422017N	Fendt	Schlepper / Favorit 700	711	0	338	437	85			
420025N	Fendt	Schlepper / Favorit 700	711	0	340	335	82			
422017N	Fendt	Schlepper / Favorit 700	712	0	338	437	85			
420025N	Fendt	Schlepper / Favorit 700	712	0	340	335	82			
422017N	Fendt	Schlepper / Favorit 700	714	0	338	437	85			
420025N	Fendt	Schlepper / Favorit 700	714	0	340	335	82			
422017N	Fendt	Schlepper / Favorit 700	716	0	338	437	85			
420025N	Fendt	Schlepper / Favorit 700	716	0	340	335	82			
422017N	Fendt	Schlepper / Favorit 800	815	0	338	437	85			
422016N	Fendt	Schlepper / Favorit 800	816	0	520	515	18		ohne Trockner	H916551061101
422017N	Fendt	Schlepper / Favorit 800	817	0	338	437	85			
422016N	Fendt	Schlepper / Favorit 800	818	0	520	515	18		ohne Trockner	H916551061101
422016N	Fendt	Schlepper / Favorit 800	822	0	520	515	18		ohne Trockner	H916551061101
422016N	Fendt	Schlepper / Favorit 800	824	0	520	515	18		ohne Trockner	H916551061101
422016N	Fendt	Schlepper / Favorit 900	916	0	520	515	18		ohne Trockner	H916551061101
420045N	Fendt	Schlepper / Favorit 900	916	0	620	525	180			
420045N	Fendt	Schlepper / Favorit 900	918	0	620	525	180			
422016N	Fendt	Schlepper / Favorit 900	920	0	520	515	18		ohne Trockner	H916551061101
420045N	Fendt	Schlepper / Favorit 900	920	0	620	525	180			
422016N	Fendt	Schlepper / Favorit 900	924	0	520	515	18		ohne Trockner	H916551061101
420045N	Fendt	Schlepper / Favorit 900	924	0	620	525	180			
422016N	Fendt	Schlepper / Favorit 900	926	0	520	515	18		ohne Trockner	H916551061101
420045N	Fendt	Schlepper / Favorit 900	926	0	620	525	180			
420045N	Fendt	Schlepper / Favorit 900	926PL	0	620	525	180			

Dasis Nr.	Hersteller	Modell	Typ	KW	Netzlänge [mm]	Netzbreite [mm]	Netztiefe [mm]	Netzmaße	mit / ohne Trockner	für OE-Nummer
420045N	Fendt	Schlepper / Favorit 900	930	0	620	525	180			
422102N	Fendt	Schlepper / Vario	207	0					ohne Trockner	FE334550010050
422102N	Fendt	Schlepper / Vario	208	0					ohne Trockner	FE334550010050
422102N	Fendt	Schlepper / Vario	209	0					ohne Trockner	FE334550010050
422102N	Fendt	Schlepper / Vario	210	0					ohne Trockner	FE334550010050
422102N	Fendt	Schlepper / Vario	211	0					ohne Trockner	FE334550010050
422089N	Fendt	Schlepper / Vario	309	0						G340550060010
422089N	Fendt	Schlepper / Vario	310	0						G340550060010
422089N	Fendt	Schlepper / Vario	311	0						G340550060010
422089N	Fendt	Schlepper / Vario	312	0						G340550060010
422089N	Fendt	Schlepper / Vario	313	0						G340550060010
422091N	Fendt	Schlepper / Vario	512	0						G416550060100
422091N	Fendt	Schlepper / Vario	513	0						G416550060100
422091N	Fendt	Schlepper / Vario	514	0						G416550060100
422091N	Fendt	Schlepper / Vario	516	0						G416550060100
422091N	Fendt	Schlepper / Vario	714	0						G416550060100
422091N	Fendt	Schlepper / Vario	716	0						G416550060100
422091N	Fendt	Schlepper / Vario	718	0						G416550060100
422091N	Fendt	Schlepper / Vario	720	0						G416550060100
422024N	Fendt	Schlepper / Vario	720	0	540	460	25			
422091N	Fendt	Schlepper / Vario	722	0						G416550060100
422024N	Fendt	Schlepper / Vario	722	0	540	460	25			
422091N	Fendt	Schlepper / Vario	724	0						G416550060100
422024N	Fendt	Schlepper / Vario	724	0	540	460	25			
422090N	Fendt	Schlepper / Vario	822	0						H842550061100
422090N	Fendt	Schlepper / Vario	824	0						H842550061100
422090N	Fendt	Schlepper / Vario	826	0						H842550061100
422090N	Fendt	Schlepper / Vario	828	0						H842550061100
422090N	Fendt	Schlepper / Vario	927	0						H842550061100



Dasis Nr.	Hersteller	Modell	Typ	KW	Netzlänge [mm]	Netzbreite [mm]	Netztiefe [mm]	Netzmaße	mit / ohne Trockner	für OE-Nummer
422090N	Fendt	Schlepper / Vario	930	0						H842550061100
422090N	Fendt	Schlepper / Vario	933	0						H842550061100
422090N	Fendt	Schlepper / Vario	936	0						H842550061100
422090N	Fendt	Schlepper / Vario	939	0						H842550061100
422102N	Fendt	Schlepper / Vario / TMS	207	0					ohne Trockner	FE334550010050
422102N	Fendt	Schlepper / Vario / TMS	208	0					ohne Trockner	FE334550010050
422102N	Fendt	Schlepper / Vario / TMS	209	0					ohne Trockner	FE334550010050
422102N	Fendt	Schlepper / Vario / TMS	210	0					ohne Trockner	FE334550010050
422102N	Fendt	Schlepper / Vario / TMS	211	0					ohne Trockner	FE334550010050
452016N	Fendt	Schlepper / Vario 200 V/F/P Serie	208 V/F	0	690	255	64		ohne Trockner	F260550010130
452016N	Fendt	Schlepper / Vario 200 V/F/P Serie	209 V/F/P	0	690	255	64		ohne Trockner	F260550010130
452016N	Fendt	Schlepper / Vario 200 V/F/P Serie	210 V/F/P	0	690	255	64		ohne Trockner	F260550010130
452016N	Fendt	Schlepper / Vario 200 V/F/P Serie	211 V/F/P	0	690	255	64		ohne Trockner	F260550010130
452017N	Fendt	Schlepper / Xylon	520	0					ohne Trockner	
452017N	Fendt	Schlepper / Xylon	522	0					ohne Trockner	
452017N	Fendt	Schlepper / Xylon	524	0					ohne Trockner	
422012N	Fiat / Hitachi	Schlepper / L	60	0	490	406	51		ohne Trockner	
422012N	Fiat / Hitachi	Schlepper / L	65	0	490	406	51		ohne Trockner	
422012N	Fiat / Hitachi	Schlepper / L	75	0	490	406	51		ohne Trockner	
422012N	Fiat / Hitachi	Schlepper / L	85	0	490	406	51		ohne Trockner	
422012N	Fiat / Hitachi	Schlepper / L	95	0	490	406	51		ohne Trockner	
422014N	Fiat / Hitachi	Schlepper / M	100	0	515	385	125		ohne Trockner	82007142
422014N	Fiat / Hitachi	Schlepper / M	115	0	515	385	125		ohne Trockner	82007142

Dasis Nr.	Hersteller	Modell	Typ	KW	Netzlänge [mm]	Netzbreite [mm]	Netztiefe [mm]	Netzmaße	mit / ohne Trockner	für OE-Nummer
422014N	Fiat / Hitachi	Schlepper / M	135	0	515	385	125		ohne Trockner	82007142
422014N	Fiat / Hitachi	Schlepper / M	160	0	515	385	125		ohne Trockner	82007142
422014N	Fiat / Hitachi	Schlepper / M	180	0	515	385	125		ohne Trockner	82007142
422014N	Fiat / Hitachi	Schlepper Wein Obst / M	100	0	515	385	125		ohne Trockner	82007142
422014N	Fiat / Hitachi	Schlepper Wein Obst / M	115	0	515	385	125		ohne Trockner	82007142
422014N	Fiat / Hitachi	Schlepper Wein Obst / M	135	0	515	385	125		ohne Trockner	82007142
422014N	Fiat / Hitachi	Schlepper Wein Obst / M	160	0	515	385	125		ohne Trockner	82007142
422014N	Fiat / Hitachi	Schlepper Wein Obst / M	180	0	515	385	125		ohne Trockner	82007142
442009N	Hattat	Schlepper / A	70	0	350	393	22			
442009N	Hattat	Schlepper / A	80	0	350	393	22			
442009N	Hattat	Schlepper / A	90	0	350	393	22			
442009N	Hattat	Schlepper / A	100	0	350	393	22			
442009N	Hattat	Schlepper / A	110	0	350	393	22			
422104N	Hitachi	Bagger / EX	100-5	0	568	343	30		ohne Trockner	4361054 4405138
422104N	Hitachi	Bagger / EX	100M-5	0	568	343	30		ohne Trockner	4361054 4405138
422104N	Hitachi	Bagger / EX	120-5	0	568	343	30		ohne Trockner	4361054 4405138
422104N	Hitachi	Bagger / EX	120-5HG	0	568	343	30		ohne Trockner	4361054 4405138
422104N	Hitachi	Bagger / EX	120-5LV	0	568	343	30		ohne Trockner	4361054 4405138
422104N	Hitachi	Bagger / EX	120-5X	0	568	343	30		ohne Trockner	4361054 4405138
422104N	Hitachi	Bagger / EX	120-5Z	0	568	343	30		ohne Trockner	4361054 4405138
422104N	Hitachi	Bagger / EX	120SS-5	0	568	343	30		ohne Trockner	4361054 4405138
422104N	Hitachi	Bagger / EX	125WD-5	0	568	343	30		ohne Trockner	4361054 4405138
422104N	Hitachi	Bagger / EX	130H-5	0	568	343	30		ohne Trockner	4361054 4405138

Dasis Nr.	Hersteller	Modell	Typ	KW	Netzlänge [mm]	Netzbreite [mm]	Netztiefe [mm]	Netzmaße	mit / ohne Trockner	für OE-Nummer
422104N	Hitachi	Bagger / EX	130K-5	0	568	343	30		ohne Trockner	4361054 4405138
422104N	Hitachi	Bagger / EX	150LC-5	0	568	343	30		ohne Trockner	4361054 4405138
422104N	Hitachi	Bagger / EX	200-3	0	568	343	30		ohne Trockner	4361054 4405138
422104N	Hitachi	Bagger / EX	200-5	0	568	343	30		ohne Trockner	4361054 4405138
422104N	Hitachi	Bagger / EX	200-5HG	0	568	343	30		ohne Trockner	4361054 4405138
422104N	Hitachi	Bagger / EX	200-5LV	0	568	343	30		ohne Trockner	4361054 4405138
422104N	Hitachi	Bagger / EX	200-5X	0	568	343	30		ohne Trockner	4361054 4405138
422104N	Hitachi	Bagger / EX	200-5Z	0	568	343	30		ohne Trockner	4361054 4405138
422104N	Hitachi	Bagger / EX	200SS-5	0	568	343	30		ohne Trockner	4361054 4405138
422104N	Hitachi	Bagger / EX	210H-5	0	568	343	30		ohne Trockner	4361054 4405138
422104N	Hitachi	Bagger / EX	210K-5	0	568	343	30		ohne Trockner	4361054 4405138
422104N	Hitachi	Bagger / EX	225USR	0	568	343	30		ohne Trockner	4361054 4405138
422104N	Hitachi	Bagger / EX	225USRK	0	568	343	30		ohne Trockner	4361054 4405138
422104N	Hitachi	Bagger / MA	145-5	0	568	343	30		ohne Trockner	4361054 4405138
422105N	Hitachi	Bagger / MA	200-G	0					ohne Trockner	4602578
422103N	Hitachi	Bagger / ZX	27U-2	0	350	390	22		ohne Trockner	4615805
422103N	Hitachi	Bagger / ZX	27U-3	0	350	390	22		ohne Trockner	4615805
422103N	Hitachi	Bagger / ZX	27U-3F	0	350	390	22		ohne Trockner	4615805
422103N	Hitachi	Bagger / ZX	29U-3	0	350	390	22		ohne Trockner	4615805
422103N	Hitachi	Bagger / ZX	29U-3F	0	350	390	22		ohne Trockner	4615805
422103N	Hitachi	Bagger / ZX	30U-2	0	350	390	22		ohne Trockner	4615805

Dasis Nr.	Hersteller	Modell	Typ	KW	Netzlänge [mm]	Netzbreite [mm]	Netztiefe [mm]	Netzmaße	mit / ohne Trockner	für OE-Nummer
422103N	Hitachi	Bagger / ZX	30U-3	0	350	390	22		ohne Trockner	4615805
422103N	Hitachi	Bagger / ZX	30U-3F	0	350	390	22		ohne Trockner	4615805
422103N	Hitachi	Bagger / ZX	30UR-2	0	350	390	22		ohne Trockner	4615805
422103N	Hitachi	Bagger / ZX	30UR-2U	0	350	390	22		ohne Trockner	4615805
422103N	Hitachi	Bagger / ZX	30UR-3	0	350	390	22		ohne Trockner	4615805
422103N	Hitachi	Bagger / ZX	33U-3	0	350	390	22		ohne Trockner	4615805
422103N	Hitachi	Bagger / ZX	33U-3F	0	350	390	22		ohne Trockner	4615805
422103N	Hitachi	Bagger / ZX	35U-2	0	350	390	22		ohne Trockner	4615805
422103N	Hitachi	Bagger / ZX	35U-3	0	350	390	22		ohne Trockner	4615805
422103N	Hitachi	Bagger / ZX	35U-3F	0	350	390	22		ohne Trockner	4615805
422103N	Hitachi	Bagger / ZX	38U-3	0	350	390	22		ohne Trockner	4615805
422103N	Hitachi	Bagger / ZX	38U-3F	0	350	390	22		ohne Trockner	4615805
422103N	Hitachi	Bagger / ZX	40U-2	0	350	390	22		ohne Trockner	4615805
422103N	Hitachi	Bagger / ZX	40U-3	0	350	390	22		ohne Trockner	4615805
422103N	Hitachi	Bagger / ZX	40U-3U	0	350	390	22		ohne Trockner	4615805
422103N	Hitachi	Bagger / ZX	40UR-2	0	350	390	22		ohne Trockner	4615805
422103N	Hitachi	Bagger / ZX	40UR-2D	0	350	390	22		ohne Trockner	4615805
422103N	Hitachi	Bagger / ZX	40UR-2DU	0	350	390	22		ohne Trockner	4615805
422103N	Hitachi	Bagger / ZX	40UR-2U	0	350	390	22		ohne Trockner	4615805
422103N	Hitachi	Bagger / ZX	40UR-3	0	350	390	22		ohne Trockner	4615805
422103N	Hitachi	Bagger / ZX	40UR-3D	0	350	390	22		ohne Trockner	4615805

Dasis Nr.	Hersteller	Modell	Typ	KW	Netzlänge [mm]	Netzbreite [mm]	Netztiefe [mm]	Netzmaße	mit / ohne Trockner	für OE-Nummer
422103N	Hitachi	Bagger / ZX	48U-3	0	350	390	22		ohne Trockner	4615805
422103N	Hitachi	Bagger / ZX	48U-3F	0	350	390	22		ohne Trockner	4615805
422103N	Hitachi	Bagger / ZX	50U-2	0	350	390	22		ohne Trockner	4615805
422103N	Hitachi	Bagger / ZX	50U-3	0	350	390	22		ohne Trockner	4615805
422103N	Hitachi	Bagger / ZX	50U-3F	0	350	390	22		ohne Trockner	4615805
422103N	Hitachi	Bagger / ZX	52U-3	0	350	390	22		ohne Trockner	4615805
422103N	Hitachi	Bagger / ZX	52U-3F	0	350	390	22		ohne Trockner	4615805
422103N	Hitachi	Bagger / ZX	55UR-2	0	350	390	22		ohne Trockner	4615805
422103N	Hitachi	Bagger / ZX	55UR-2D	0	350	390	22		ohne Trockner	4615805
422103N	Hitachi	Bagger / ZX	55UR-2DU	0	350	390	22		ohne Trockner	4615805
422103N	Hitachi	Bagger / ZX	55UR-2U	0	350	390	22		ohne Trockner	4615805
422105N	Hitachi	Bagger / ZX	125US	0					ohne Trockner	4602578
422105N	Hitachi	Bagger / ZX	125US-E	0					ohne Trockner	4602578
422104N	Hitachi	Bagger / ZX	125W	0	568	343	30		ohne Trockner	4361054 4405138
422105N	Hitachi	Bagger / ZX	135UR	0					ohne Trockner	4602578
422105N	Hitachi	Bagger / ZX	135US	0					ohne Trockner	4602578
422105N	Hitachi	Bagger / ZX	135US-E	0					ohne Trockner	4602578
422105N	Hitachi	Bagger / ZX	135USK	0					ohne Trockner	4602578
422105N	Hitachi	Bagger / ZX	135UST	0					ohne Trockner	4602578
422105N	Hitachi	Bagger / ZX	200	0					ohne Trockner	4602578
422105N	Hitachi	Bagger / ZX	200-3G	0					ohne Trockner	4602578

Dasis Nr.	Hersteller	Modell	Typ	KW	Netzlänge [mm]	Netzbreite [mm]	Netztiefe [mm]	Netzmaße	mit / ohne Trockner	für OE-Nummer
422105N	Hitachi	Bagger / ZX	200-E	0					ohne Trockner	4602578
422105N	Hitachi	Bagger / ZX	200-X	0					ohne Trockner	4602578
422105N	Hitachi	Bagger / ZX	210H	0					ohne Trockner	4602578
422105N	Hitachi	Bagger / ZX	210H-3G	0					ohne Trockner	4602578
422105N	Hitachi	Bagger / ZX	210K	0					ohne Trockner	4602578
422105N	Hitachi	Bagger / ZX	210K-3G	0					ohne Trockner	4602578
422105N	Hitachi	Bagger / ZX	210LC-3G	0					ohne Trockner	4602578
422105N	Hitachi	Bagger / ZX	210W	0					ohne Trockner	4602578
422105N	Hitachi	Bagger / ZX	225US	0					ohne Trockner	4602578
422105N	Hitachi	Bagger / ZX	225US-E	0					ohne Trockner	4602578
422105N	Hitachi	Bagger / ZX	225USR	0					ohne Trockner	4602578
422105N	Hitachi	Bagger / ZX	225USR-E	0					ohne Trockner	4602578
422105N	Hitachi	Bagger / ZX	225USRK	0					ohne Trockner	4602578
422105N	Hitachi	Bagger / ZX	230	0					ohne Trockner	4602578
422105N	Hitachi	Bagger / ZX	240-3G	0					ohne Trockner	4602578
422105N	Hitachi	Bagger / ZX	240H	0					ohne Trockner	4602578
422105N	Hitachi	Bagger / ZX	240K	0					ohne Trockner	4602578
422105N	Hitachi	Bagger / ZX	240LC-3G	0					ohne Trockner	4602578
422105N	Hitachi	Bagger / ZX	250H-3G	0					ohne Trockner	4602578
422105N	Hitachi	Bagger / ZX	250K-3G	0					ohne Trockner	4602578
422105N	Hitachi	Bagger / ZX	250LC-3G	0					ohne Trockner	4602578

Dasis Nr.	Hersteller	Modell	Typ	KW	Netzlänge [mm]	Netzbreite [mm]	Netztiefe [mm]	Netzmaße	mit / ohne Trockner	für OE-Nummer
422105N	Hitachi	Bagger / ZX	250LCH-3G	0					ohne Trockner	4602578
422105N	Hitachi	Bagger / ZX	250LCK-3G	0					ohne Trockner	4602578
422105N	Hitachi	Bagger / ZX	260LCH-3G	0					ohne Trockner	4602578
422105N	Hitachi	Bagger / ZX	330	0					ohne Trockner	4602578
422105N	Hitachi	Bagger / ZX	330-3G	0					ohne Trockner	4602578
422105N	Hitachi	Bagger / ZX	330LC-3G	0					ohne Trockner	4602578
422105N	Hitachi	Bagger / ZX	350H	0					ohne Trockner	4602578
422105N	Hitachi	Bagger / ZX	350H-3G	0					ohne Trockner	4602578
422105N	Hitachi	Bagger / ZX	350K	0					ohne Trockner	4602578
422105N	Hitachi	Bagger / ZX	350K-3G	0					ohne Trockner	4602578
422105N	Hitachi	Bagger / ZX	350LCH-3G	0					ohne Trockner	4602578
422105N	Hitachi	Bagger / ZX	350LCK-3G	0					ohne Trockner	4602578
422105N	Hitachi	Bagger / ZX	350W	0					ohne Trockner	4602578
422105N	Hitachi	Bagger / ZX	360H-3G	0					ohne Trockner	4602578
422105N	Hitachi	Bagger / ZX	370MTH	0					ohne Trockner	4602578
422105N	Hitachi	Bagger / ZX	500W	0					ohne Trockner	4602578
422105N	Hitachi	Kran / UCX	300	0					ohne Trockner	4602578
422104N	Hitachi	Muldenkipper / CHR	70	0	568	343	30		ohne Trockner	4361054 4405138
422031N	Hitachi	Zaxis	75	0						
422031N	Hitachi	Zaxis	85	0						
422031N	Hitachi	Zaxis	120	0						
422031N	Hitachi	Zaxis	135	0						
422031N	Hitachi	Zaxis	160	0						

Dasis Nr.	Hersteller	Modell	Typ	KW	Netzlänge [mm]	Netzbreite [mm]	Netztiefe [mm]	Netzmaße	mit / ohne Trockner	für OE-Nummer
422031N	Hitachi	Zaxis	190	0						
422031N	Hitachi	Zaxis	200	0						
422031N	Hitachi	Zaxis	210	0						
422031N	Hitachi	Zaxis	220	0						
422031N	Hitachi	Zaxis	240	0						
422031N	Hitachi	Zaxis	250	0						
422031N	Hitachi	Zaxis	270	0						
422031N	Hitachi	Zaxis	280	0						
422031N	Hitachi	Zaxis	330	0						
422031N	Hitachi	Zaxis	350	0						
422107N	Hyundai	Bagger / R	110-7	0	470	360	16			11EM90050 11EM90050CL
422107N	Hyundai	Bagger / R	110-7A	0	470	360	16			11EM90050 11EM90050CL
422107N	Hyundai	Bagger / R	140LC-7	0	470	360	16			11EM90050 11EM90050CL
422107N	Hyundai	Bagger / R	140LC-7A	0	470	360	16			11EM90050 11EM90050CL
422106N	Hyundai	Bagger / R	140LC-9	0	590	445	22		mit Trockner	11Q690071 A2W01433
422107N	Hyundai	Bagger / R	140W-7	0	470	360	16			11EM90050 11EM90050CL
422107N	Hyundai	Bagger / R	140W-7A	0	470	360	16			11EM90050 11EM90050CL
422106N	Hyundai	Bagger / R	140W-9	0	590	445	22		mit Trockner	11Q690071 A2W01433
422107N	Hyundai	Bagger / R	160LC-7	0	470	360	16			11EM90050 11EM90050CL
422107N	Hyundai	Bagger / R	160LC-7A	0	470	360	16			11EM90050 11EM90050CL
422106N	Hyundai	Bagger / R	160LC-9	0	590	445	22		mit Trockner	11Q690071 A2W01433
422107N	Hyundai	Bagger / R	170W-7	0	470	360	16			11EM90050 11EM90050CL
422107N	Hyundai	Bagger / R	170W-7A	0	470	360	16			11EM90050 11EM90050CL
422106N	Hyundai	Bagger / R	170W-9	0	590	445	22		mit Trockner	11Q690071 A2W01433
422107N	Hyundai	Bagger / R	180LC-7	0	470	360	16			11EM90050 11EM90050CL
422107N	Hyundai	Bagger / R	180LC-7A	0	470	360	16			11EM90050 11EM90050CL



Dasis Nr.	Hersteller	Modell	Typ	KW	Netzlänge [mm]	Netzbreite [mm]	Netztiefe [mm]	Netzmaße	mit / ohne Trockner	für OE-Nummer
422106N	Hyundai	Bagger / R	180LC-9	0	590	445	22		mit Trockner	11Q690071 A2W01433
422107N	Hyundai	Bagger / R	200W-7	0	470	360	16			11EM90050 11EM90050CL
422107N	Hyundai	Bagger / R	200W-7A	0	470	360	16			11EM90050 11EM90050CL
422107N	Hyundai	Bagger / R	210-7	0	470	360	16			11EM90050 11EM90050CL
422107N	Hyundai	Bagger / R	210LC-7	0	470	360	16			11EM90050 11EM90050CL
422107N	Hyundai	Bagger / R	210LC-7A	0	470	360	16			11EM90050 11EM90050CL
422107N	Hyundai	Bagger / R	210LC-7H	0	470	360	16			11EM90050 11EM90050CL
422106N	Hyundai	Bagger / R	210LC-9	0	590	445	22		mit Trockner	11Q690071 A2W01433
422107N	Hyundai	Bagger / R	210NLC-7	0	470	360	16			11EM90050 11EM90050CL
422107N	Hyundai	Bagger / R	210NLC-7A	0	470	360	16			11EM90050 11EM90050CL
422106N	Hyundai	Bagger / R	210NLC-9	0	590	445	22		mit Trockner	11Q690071 A2W01433
422107N	Hyundai	Bagger / R	220LC-7	0	470	360	16			11EM90050 11EM90050CL
422106N	Hyundai	Bagger / R	235LCR-9	0	590	445	22		mit Trockner	11Q690071 A2W01433
422107N	Hyundai	Bagger / R	250LC-7	0	470	360	16			11EM90050 11EM90050CL
422107N	Hyundai	Bagger / R	250LC-7A	0	470	360	16			11EM90050 11EM90050CL
422106N	Hyundai	Bagger / R	250LC-9	0	590	445	22		mit Trockner	11Q690071 A2W01433
422107N	Hyundai	Bagger / R	290LC-7	0	470	360	16			11EM90050 11EM90050CL
422107N	Hyundai	Bagger / R	290LC-7A	0	470	360	16			11EM90050 11EM90050CL
422107N	Hyundai	Bagger / R	290LC-7H	0	470	360	16			11EM90050 11EM90050CL
422106N	Hyundai	Bagger / R	290LC-9	0	590	445	22		mit Trockner	11Q690071 A2W01433
422107N	Hyundai	Bagger / R	300LC-7	0	470	360	16			11EM90050 11EM90050CL
422107N	Hyundai	Bagger / R	305LC-7	0	470	360	16			11EM90050 11EM90050CL
422107N	Hyundai	Bagger / R	320LC-7	0	470	360	16			11EM90050 11EM90050CL

Dasis Nr.	Hersteller	Modell	Typ	KW	Netzlänge [mm]	Netzbreite [mm]	Netztiefe [mm]	Netzmaße	mit / ohne Trockner	für OE-Nummer
422107N	Hyundai	Bagger / R	320LC-7A	0	470	360	16			11EM90050 11EM90050CL
422106N	Hyundai	Bagger / R	320LC-9	0	590	445	22		mit Trockner	11Q690071 A2W01433
422107N	Hyundai	Bagger / R	360LC-7	0	470	360	16			11EM90050 11EM90050CL
422107N	Hyundai	Bagger / R	360LC-7A	0	470	360	16			11EM90050 11EM90050CL
422106N	Hyundai	Bagger / R	360LC-9	0	590	445	22		mit Trockner	11Q690071 A2W01433
422107N	Hyundai	Bagger / R	370LC-7	0	470	360	16			11EM90050 11EM90050CL
422106N	Hyundai	Bagger / R	480LC-9	0	590	445	22		mit Trockner	11Q690071 A2W01433
422106N	Hyundai	Bagger / R	520LC-9	0	590	445	22		mit Trockner	11Q690071 A2W01433
422107N	Hyundai	Bagger / R	800LC-7A	0	470	360	16			11EM90050 11EM90050CL
422106N	Hyundai	Schaufellader / HL	730-9	0	590	445	22		mit Trockner	11Q690071 A2W01433
422106N	Hyundai	Schaufellader / HL	730TM-9	0	590	445	22		mit Trockner	11Q690071 A2W01433
422106N	Hyundai	Schaufellader / HL	757TM-7A	0	590	445	22		mit Trockner	11Q690071 A2W01433
422106N	Hyundai	Schaufellader / HL	760-7A	0	590	445	22		mit Trockner	11Q690071 A2W01433
422107N	Hyundai	Schaufellader / HL	770-7	0	470	360	16			11EM90050 11EM90050CL
422106N	Hyundai	Schaufellader / HL	770-7A	0	590	445	22		mit Trockner	11Q690071 A2W01433
422106N	Hyundai	Schaufellader / HL	780-7A	0	590	445	22		mit Trockner	11Q690071 A2W01433
420016N	JCB	Bagger 360 ° / JS	130	0						
420016N	JCB	Bagger 360 ° / JS	130VV	0						
420016N	JCB	Bagger 360 ° / JS	130VV-P	0						
420016N	JCB	Bagger 360 ° / JS	145VV	0						
420016N	JCB	Bagger 360 ° / JS	150VV	0						
420016N	JCB	Bagger 360 ° / JS	160	0						
420016N	JCB	Bagger 360 ° / JS	160VV	0						
420016N	JCB	Bagger 360 ° / JS	160VV-P	0						
420016N	JCB	Bagger 360 ° / JS	175VV	0						
420016N	JCB	Bagger 360 ° / JS	180	0						
452013N	JCB	Bagger 360 ° / JS	190	0	597	359	16		mit Trockner	30/926977 30926977
420016N	JCB	Bagger 360 ° / JS	200	0						
452013N	JCB	Bagger 360 ° / JS	200	0	597	359	16		mit Trockner	30/926977 30926977

Dasis Nr.	Hersteller	Modell	Typ	KW	Netzlänge [mm]	Netzbreite [mm]	Netztiefe [mm]	Netzmaße	mit / ohne Trockner	für OE-Nummer
420016N	JCB	Bagger 360 ° / JS	200W	0						
452013N	JCB	Bagger 360 ° / JS	200W	0	597	359	16		mit Trockner	30/926977 30926977
420016N	JCB	Bagger 360 ° / JS	200W-P	0						
452013N	JCB	Bagger 360 ° / JS	200W-P	0	597	359	16		mit Trockner	30/926977 30926977
420016N	JCB	Bagger 360 ° / JS	210	0						
452013N	JCB	Bagger 360 ° / JS	210	0	597	359	16		mit Trockner	30/926977 30926977
420016N	JCB	Bagger 360 ° / JS	220	0						
452013N	JCB	Bagger 360 ° / JS	220	0	597	359	16		mit Trockner	30/926977 30926977
452013N	JCB	Bagger 360 ° / JS	235	0	597	359	16		mit Trockner	30/926977 30926977
420016N	JCB	Bagger 360 ° / JS	240	0						
420016N	JCB	Bagger 360 ° / JS	260	0						
420016N	JCB	Bagger 360 ° / JS	330	0						
452011N	JCB	Baggerlader / 400	426	0						
452011N	JCB	Baggerlader / 400	426B	0						
452011N	JCB	Baggerlader / 400	434	0						
452011N	JCB	Baggerlader / 400	436	0						
452011N	JCB	Baggerlader / 400	436B	0						
452011N	JCB	Baggerlader / 400	456	0						
422093N	JCB	Kipper	714	0						30913900
422093N	JCB	Kipper	718	0						30913900
422092N	JCB	Schlepper / Fastrac 100	125	0						30904500 30905500
422092N	JCB	Schlepper / Fastrac 100	125-30	0						30904500 30905500
422092N	JCB	Schlepper / Fastrac 100	125-40	0						30904500 30905500
422092N	JCB	Schlepper / Fastrac 100	125-55	0						30904500 30905500
420013N	JCB	Schlepper / Fastrac 100	125-65	0						
422092N	JCB	Schlepper / Fastrac 100	125-65	0						30904500 30905500
422092N	JCB	Schlepper / Fastrac 100	130	0						30904500 30905500
420013N	JCB	Schlepper / Fastrac 100	130-65	0						
422092N	JCB	Schlepper / Fastrac 100	130-65	0						30904500 30905500
422092N	JCB	Schlepper / Fastrac 100	130T	0						30904500 30905500
422092N	JCB	Schlepper / Fastrac 100	130T30	0						30904500 30905500

Dasis Nr.	Hersteller	Modell	Typ	KW	Netzlänge [mm]	Netzbreite [mm]	Netztiefe [mm]	Netzmaße	mit / ohne Trockner	für OE-Nummer
422092N	JCB	Schlepper / Fastrac 100	130T40	0						30904500 30905500
422092N	JCB	Schlepper / Fastrac 100	130T55	0						30904500 30905500
422092N	JCB	Schlepper / Fastrac 100	130T65	0						30904500 30905500
422092N	JCB	Schlepper / Fastrac 100	135	0						30904500 30905500
422092N	JCB	Schlepper / Fastrac 100	135T	0						30904500 30905500
422092N	JCB	Schlepper / Fastrac 100	145	0						30904500 30905500
420013N	JCB	Schlepper / Fastrac 100	145-65	0						
422092N	JCB	Schlepper / Fastrac 100	145-65	0						30904500 30905500
422092N	JCB	Schlepper / Fastrac 100	145T	0						30904500 30905500
422092N	JCB	Schlepper / Fastrac 100	145T30	0						30904500 30905500
422092N	JCB	Schlepper / Fastrac 100	145T40	0						30904500 30905500
422092N	JCB	Schlepper / Fastrac 100	145T55	0						30904500 30905500
422092N	JCB	Schlepper / Fastrac 100	145T65	0						30904500 30905500
422092N	JCB	Schlepper / Fastrac 100	150	0						30904500 30905500
420013N	JCB	Schlepper / Fastrac 100	150-65	0						
422092N	JCB	Schlepper / Fastrac 100	150-65	0						30904500 30905500
422092N	JCB	Schlepper / Fastrac 100	150T	0						30904500 30905500
422092N	JCB	Schlepper / Fastrac 100	150T40	0						30904500 30905500
422092N	JCB	Schlepper / Fastrac 100	150T55	0						30904500 30905500
422092N	JCB	Schlepper / Fastrac 100	150T65	0						30904500 30905500
422092N	JCB	Schlepper / Fastrac 100	155	0						30904500 30905500
422092N	JCB	Schlepper / Fastrac 100	155T	0						30904500 30905500
422092N	JCB	Schlepper / Fastrac 100	185	0						30904500 30905500
420013N	JCB	Schlepper / Fastrac 1000	1115	0						
422093N	JCB	Schlepper / Fastrac 1000	1115	0						30913900
420013N	JCB	Schlepper / Fastrac 1000	1115S	0						
422093N	JCB	Schlepper / Fastrac 1000	1115S	0						30913900
420013N	JCB	Schlepper / Fastrac 1000	1125	0						
422093N	JCB	Schlepper / Fastrac 1000	1125	0						30913900
420013N	JCB	Schlepper / Fastrac 1000	1135	0						
422093N	JCB	Schlepper / Fastrac 1000	1135	0						30913900

Dasis Nr.	Hersteller	Modell	Typ	KW	Netzlänge [mm]	Netzbreite [mm]	Netztiefe [mm]	Netzmaße	mit / ohne Trockner	für OE-Nummer
422092N	JCB	Schlepper / Fastrac 2000	2115	0						30904500 30905500
422093N	JCB	Schlepper / Fastrac 2000	2115	0						30913900
422092N	JCB	Schlepper / Fastrac 2000	2125	0						30904500 30905500
422092N	JCB	Schlepper / Fastrac 2000	2135	0						30904500 30905500
422093N	JCB	Schlepper / Fastrac 2000	2140	0						30913900
422092N	JCB	Schlepper / Fastrac 2000	2150	0						30904500 30905500
422093N	JCB	Schlepper / Fastrac 2000	2150	0						30913900
422093N	JCB	Schlepper / Fastrac 3000	3155	0						30913900
422056N	JCB	Schlepper / Fastrac 3000	3170	0	465	485	45			
422093N	JCB	Schlepper / Fastrac 3000	3185	0						30913900
422056N	JCB	Schlepper / Fastrac 3000	3190	0	465	485	45			
422056N	JCB	Schlepper / Fastrac 3000	3200	0	465	485	45			
422056N	JCB	Schlepper / Fastrac 3000	3220	0	465	485	45			
422056N	JCB	Schlepper / Fastrac 3000	3230	0	465	485	45			
422092N	JCB	Teleskopplader / 500 Serie	520	0						30904500 30905500
420013N	JCB	Teleskopplader / 500 Serie	520HL	0						
422092N	JCB	Teleskopplader / 500 Serie	520HL	0						30904500 30905500
420013N	JCB	Teleskopplader / 500 Serie	520M	0						
422092N	JCB	Teleskopplader / 500 Serie	520M	0						30904500 30905500
422092N	JCB	Teleskopplader / 500 Serie	520S	0						30904500 30905500
420013N	JCB	Teleskopplader / 500 Serie	525	0						
422092N	JCB	Teleskopplader / 500 Serie	526	0						30904500 30905500
422092N	JCB	Teleskopplader / 500 Serie	526-56	0						30904500 30905500
422092N	JCB	Teleskopplader / 500 Serie	526-58	0						30904500 30905500
422092N	JCB	Teleskopplader / 500 Serie	526-67	0						30904500 30905500
420009N	JCB	Teleskopplader / 500 Serie	526S	0						
422092N	JCB	Teleskopplader / 500 Serie	526S	0						30904500 30905500
422092N	JCB	Teleskopplader / 500 Serie	528/70	0						30904500 30905500
422092N	JCB	Teleskopplader / 500 Serie	528AG	0						30904500 30905500
422092N	JCB	Teleskopplader / 500 Serie	528S	0						30904500 30905500
422092N	JCB	Teleskopplader / 500 Serie	530	0						30904500 30905500

Dasis Nr.	Hersteller	Modell	Typ	KW	Netzlänge [mm]	Netzbreite [mm]	Netztiefe [mm]	Netzmaße	mit / ohne Trockner	für OE-Nummer
422092N	JCB	Teleskoplader / 500 Serie	530-67	0						30904500 30905500
422092N	JCB	Teleskoplader / 500 Serie	530-95	0						30904500 30905500
422092N	JCB	Teleskoplader / 500 Serie	530-110	0						30904500 30905500
422092N	JCB	Teleskoplader / 500 Serie	530-120	0						30904500 30905500
422092N	JCB	Teleskoplader / 500 Serie	530B	0						30904500 30905500
422092N	JCB	Teleskoplader / 500 Serie	530BHL	0						30904500 30905500
422092N	JCB	Teleskoplader / 500 Serie	530FS	0						30904500 30905500
422092N	JCB	Teleskoplader / 500 Serie	530FSPlus	0						30904500 30905500
422092N	JCB	Teleskoplader / 500 Serie	530FSSUPER	0						30904500 30905500
422092N	JCB	Teleskoplader / 500 Serie	530HL	0						30904500 30905500
422092N	JCB	Teleskoplader / 500 Serie	530S	0						30904500 30905500
422092N	JCB	Teleskoplader / 500 Serie	530SL	0						30904500 30905500
422092N	JCB	Teleskoplader / 500 Serie	530SUPERAG	0						30904500 30905500
422092N	JCB	Teleskoplader / 500 Serie	530S XL	0						30904500 30905500
422092N	JCB	Teleskoplader / 500 Serie	532	0						30904500 30905500
422093N	JCB	Teleskoplader / 500 Serie	532	0						30913900
422092N	JCB	Teleskoplader / 500 Serie	532H	0						30904500 30905500
422093N	JCB	Teleskoplader / 500 Serie	532H	0						30913900
422092N	JCB	Teleskoplader / 500 Serie	533-105	0						30904500 30905500
422092N	JCB	Teleskoplader / 500 Serie	535	0						30904500 30905500
422092N	JCB	Teleskoplader / 500 Serie	535-95	0						30904500 30905500
422093N	JCB	Teleskoplader / 500 Serie	535-95	0						30913900
422092N	JCB	Teleskoplader / 500 Serie	535-140	0						30904500 30905500
422092N	JCB	Teleskoplader / 500 Serie	537	0						30904500 30905500
422093N	JCB	Teleskoplader / 500 Serie	537	0						30913900
422092N	JCB	Teleskoplader / 500 Serie	537-120	0						30904500 30905500
422093N	JCB	Teleskoplader / 500 Serie	537-120	0						30913900
422092N	JCB	Teleskoplader / 500 Serie	537-130	0						30904500 30905500
422093N	JCB	Teleskoplader / 500 Serie	537-130	0						30913900
422092N	JCB	Teleskoplader / 500 Serie	537H	0						30904500 30905500
422093N	JCB	Teleskoplader / 500 Serie	537H	0						30913900

Dasis Nr.	Hersteller	Modell	Typ	KW	Netzlänge [mm]	Netzbreite [mm]	Netztiefe [mm]	Netzmaße	mit / ohne Trockner	für OE-Nummer
422092N	JCB	Teleskoplader / 500 Serie	540	0						30904500 30905500
422093N	JCB	Teleskoplader / 500 Serie	540	0						30913900
422092N	JCB	Teleskoplader / 500 Serie	540B	0						30904500 30905500
422093N	JCB	Teleskoplader / 500 Serie	540B	0						30913900
422092N	JCB	Teleskoplader / 500 Serie	540BM	0						30904500 30905500
422093N	JCB	Teleskoplader / 500 Serie	540BM	0						30913900
422092N	JCB	Teleskoplader / 500 Serie	540FS	0						30904500 30905500
422093N	JCB	Teleskoplader / 500 Serie	540FS	0						30913900
422092N	JCB	Teleskoplader / 500 Serie	540FSPlus	0						30904500 30905500
422093N	JCB	Teleskoplader / 500 Serie	540FSPlus	0						30913900
422092N	JCB	Teleskoplader / 500 Serie	540FSSUPER	0						30904500 30905500
422093N	JCB	Teleskoplader / 500 Serie	540FSSUPER	0						30913900
422092N	JCB	Teleskoplader / 500 Serie	540S	0						30904500 30905500
422093N	JCB	Teleskoplader / 500 Serie	540S	0						30913900
422092N	JCB	Teleskoplader / 500 Serie	540SL	0						30904500 30905500
422093N	JCB	Teleskoplader / 500 Serie	540SL	0						30913900
422093N	JCB	Teleskoplader / 500 Serie	540SUPERAG	0						30913900
422092N	JCB	Teleskoplader / 500 Serie	540S XL	0						30904500 30905500
422093N	JCB	Teleskoplader / 500 Serie	540S XL	0						30913900
452009N	JCB	Teleskoplader / TM	300	0					ohne Trockner	30926086 30926331
452009N	JCB	Teleskoplader / TM	310	0					ohne Trockner	30926086 30926331
452009N	JCB	Teleskoplader / TM	320	0					ohne Trockner	30926086 30926331
422103N	John Deere	Bagger	27D	0	350	390	22		ohne Trockner	4615805
422103N	John Deere	Bagger	35D	0	350	390	22		ohne Trockner	4615805
422103N	John Deere	Bagger	50D	0	350	390	22		ohne Trockner	4615805
422005N	John Deere	Mähdrescher / 900-1188	955	0	730	430	50			8846020370
422005N	John Deere	Mähdrescher / 900-1188	965	0	730	430	50			8846020370
422005N	John Deere	Mähdrescher / 900-1188	975	0	730	430	50			8846020370
422005N	John Deere	Mähdrescher / 900-1188	985	0	730	430	50			8846020370

Dasis Nr.	Hersteller	Modell	Typ	KW	Netzlänge [mm]	Netzbreite [mm]	Netztiefe [mm]	Netzmaße	mit / ohne Trockner	für OE-Nummer
422005N	John Deere	Mähdrescher / 900-1188	1052	0	730	430	50			8846020370
422005N	John Deere	Mähdrescher / 900-1188	1055	0	730	430	50			8846020370
422005N	John Deere	Mähdrescher / 900-1188	1065	0	730	430	50			8846020370
422005N	John Deere	Mähdrescher / 900-1188	1068H	0	730	430	50			8846020370
422005N	John Deere	Mähdrescher / 900-1188	1072	0	730	430	50			8846020370
422005N	John Deere	Mähdrescher / 900-1188	1075	0	730	430	50			8846020370
422005N	John Deere	Mähdrescher / 900-1188	1075H4	0	730	430	50			8846020370
422005N	John Deere	Mähdrescher / 900-1188	1085	0	730	430	50			8846020370
422005N	John Deere	Mähdrescher / 900-1188	1085H4	0	730	430	50			8846020370
422005N	John Deere	Mähdrescher / 900-1188	1155	0	730	430	50			8846020370
422005N	John Deere	Mähdrescher / 900-1188	1157	0	730	430	50			8846020370
422005N	John Deere	Mähdrescher / 900-1188	1158	0	730	430	50			8846020370
422005N	John Deere	Mähdrescher / 900-1188	1166	0	730	430	50			8846020370
422005N	John Deere	Mähdrescher / 900-1188	1169	0	730	430	50			8846020370
422005N	John Deere	Mähdrescher / 900-1188	1169H	0	730	430	50			8846020370
422005N	John Deere	Mähdrescher / 900-1188	1169H4	0	730	430	50			8846020370
422005N	John Deere	Mähdrescher / 900-1188	1170	0	730	430	50			8846020370
422005N	John Deere	Mähdrescher / 900-1188	1174	0	730	430	50			8846020370
422005N	John Deere	Mähdrescher / 900-1188	1175	0	730	430	50			8846020370
422005N	John Deere	Mähdrescher / 900-1188	1177	0	730	430	50			8846020370
422005N	John Deere	Mähdrescher / 900-1188	1177H4	0	730	430	50			8846020370
422005N	John Deere	Mähdrescher / 900-1188	1188	0	730	430	50			8846020370
422005N	John Deere	Mähdrescher / 900-1188	1188H4	0	730	430	50			8846020370
422005N	John Deere	Mähdrescher / 4000-8850	7700	0	730	430	50			8846020370
422005N	John Deere	Mähdrescher / 4000-8850	7720	0	730	430	50			8846020370
422005N	John Deere	Mähdrescher / 4000-8850	7722	0	730	430	50			8846020370
422005N	John Deere	Mähdrescher / 4000-8850	8820	0	730	430	50			8846020370
422025N	John Deere	Mähdrescher / 9000-9980	9960	0						
422025N	John Deere	Mähdrescher / 9000-9980	9965	0						



Dasis Nr.	Hersteller	Modell	Typ	KW	Netzlänge [mm]	Netzbreite [mm]	Netztiefe [mm]	Netzmaße	mit / ohne Trockner	für OE-Nummer
422025N	John Deere	Mähdrescher / 9000-9980	9970	0						
452005N	John Deere	Mähdrescher / CTS	9400	0	848	578	132		ohne Trockner	
422075N	John Deere	Mähdrescher / CTS	9400	0	902	400	22		ohne Trockner	
422075N	John Deere	Mähdrescher / CTS	9410	0	902	400	22		ohne Trockner	
422075N	John Deere	Mähdrescher / CTS	9450	0	902	400	22		ohne Trockner	
452005N	John Deere	Mähdrescher / CTS	9500	0	848	578	132		ohne Trockner	
422075N	John Deere	Mähdrescher / CTS	9500	0	902	400	22		ohne Trockner	
422075N	John Deere	Mähdrescher / CTS	9510	0	902	400	22		ohne Trockner	
422075N	John Deere	Mähdrescher / CTS	9550	0	902	400	22		ohne Trockner	
452005N	John Deere	Mähdrescher / CTS	9600	0	848	578	132		ohne Trockner	
422075N	John Deere	Mähdrescher / CTS	9600	0	902	400	22		ohne Trockner	
422075N	John Deere	Mähdrescher / CTS	9610	0	902	400	22		ohne Trockner	
422075N	John Deere	Mähdrescher / CTS	9650	0	902	400	22		ohne Trockner	
422075N	John Deere	Mähdrescher / CTS	9660	0	902	400	22		ohne Trockner	
422003N	John Deere	Schlepper / 300-955	840	0	447	356	31			
422003N	John Deere	Schlepper / 300-955	940	0	447	356	31			
422003N	John Deere	Schlepper / 1000-1950	1040	0	447	356	31			
422003N	John Deere	Schlepper / 1000-1950	1140	0	447	356	31			
422004N	John Deere	Schlepper / 1000-1950	1350	0	443	364	32			
422004N	John Deere	Schlepper / 1000-1950	1550	0	443	364	32			
422003N	John Deere	Schlepper / 1000-1950	1640	0	447	356	31			
422004N	John Deere	Schlepper / 1000-1950	1750	0	443	364	32			
422003N	John Deere	Schlepper / 1000-1950	1840	0	447	356	31			
422004N	John Deere	Schlepper / 1000-1950	1850	0	443	364	32			
422004N	John Deere	Schlepper / 1000-1950	1950	0	443	364	32			

Dasis Nr.	Hersteller	Modell	Typ	KW	Netzlänge [mm]	Netzbreite [mm]	Netztiefe [mm]	Netzmaße	mit / ohne Trockner	für OE-Nummer
422003N	John Deere	Schlepper / 2000-2955	2040	0	447	356	31			
422003N	John Deere	Schlepper / 2000-2955	2040S	0	447	356	31			
422003N	John Deere	Schlepper / 2000-2955	2140	0	447	356	31			
422003N	John Deere	Schlepper / 2000-2955	2240	0	447	356	31			
422004N	John Deere	Schlepper / 2000-2955	2250	0	443	364	32			
422004N	John Deere	Schlepper / 2000-2955	2450	0	443	364	32			
422004N	John Deere	Schlepper / 2000-2955	2550	0	443	364	32			
422004N	John Deere	Schlepper / 2000-2955	2650	0	443	364	32			
422004N	John Deere	Schlepper / 2000-2955	2850	0	443	364	32			
422003N	John Deere	Schlepper / 3000-3650	3040	0	447	356	31			
422004N	John Deere	Schlepper / 3000-3650	3050	0	443	364	32			
422003N	John Deere	Schlepper / 3000-3650	3140	0	447	356	31			
422004N	John Deere	Schlepper / 3000-3650	3150	0	443	364	32			
452014N	John Deere	Schlepper / 3000-3650	3320	0	362	381	22			MIU10003
422003N	John Deere	Schlepper / 3000-3650	3340	0	447	356	31			
422004N	John Deere	Schlepper / 3000-3650	3350	0	443	364	32			
452014N	John Deere	Schlepper / 3000-3650	3520	0	362	381	22			MIU10003
422003N	John Deere	Schlepper / 3000-3650	3640	0	447	356	31			
422004N	John Deere	Schlepper / 3000-3650	3650	0	443	364	32			
452014N	John Deere	Schlepper / 3000-3650	3720	0	362	381	22			MIU10003
422003N	John Deere	Schlepper / 4000-4955	4040	0	447	356	31			
422072N	John Deere	Schlepper / 4000-4955	4040	0	502	470	63		ohne Trockner	
422003N	John Deere	Schlepper / 4000-4955	4040S	0	447	356	31			
422072N	John Deere	Schlepper / 4000-4955	4040S	0	502	470	63		ohne Trockner	
422004N	John Deere	Schlepper / 4000-4955	4050	0	443	364	32			
422070N	John Deere	Schlepper / 4000-4955	4050	0	560	515	76		ohne Trockner	
422070N	John Deere	Schlepper / 4000-4955	4055	0	560	515	76		ohne Trockner	
422072N	John Deere	Schlepper / 4000-4955	4230	0	502	470	63		ohne Trockner	
422003N	John Deere	Schlepper / 4000-4955	4240	0	447	356	31			

Dasis Nr.	Hersteller	Modell	Typ	KW	Netzlänge [mm]	Netzbreite [mm]	Netztiefe [mm]	Netzmaße	mit / ohne Trockner	für OE-Nummer
422071N	John Deere	Schlepper / 4000-4955	4240	0	560	520	64		ohne Trockner	
422003N	John Deere	Schlepper / 4000-4955	4240S	0	447	356	31			
422071N	John Deere	Schlepper / 4000-4955	4240S	0	560	520	64		ohne Trockner	
422004N	John Deere	Schlepper / 4000-4955	4250	0	443	364	32			
422070N	John Deere	Schlepper / 4000-4955	4250	0	560	515	76		ohne Trockner	
422070N	John Deere	Schlepper / 4000-4955	4255	0	560	515	76		ohne Trockner	
452014N	John Deere	Schlepper / 4000-4955	4320	0	362	381	22			MIU10003
422004N	John Deere	Schlepper / 4000-4955	4350	0	443	364	32			
422072N	John Deere	Schlepper / 4000-4955	4430	0	502	470	63		ohne Trockner	
422003N	John Deere	Schlepper / 4000-4955	4440	0	447	356	31			
422071N	John Deere	Schlepper / 4000-4955	4440	0	560	520	64		ohne Trockner	
422004N	John Deere	Schlepper / 4000-4955	4450	0	443	364	32			
422070N	John Deere	Schlepper / 4000-4955	4450	0	560	515	76		ohne Trockner	
452014N	John Deere	Schlepper / 4000-4955	4520	0	362	381	22			MIU10003
422070N	John Deere	Schlepper / 4000-4955	4555	0	560	515	76		ohne Trockner	
422072N	John Deere	Schlepper / 4000-4955	4630	0	502	470	63		ohne Trockner	
422003N	John Deere	Schlepper / 4000-4955	4640	0	447	356	31			
422071N	John Deere	Schlepper / 4000-4955	4640	0	560	520	64		ohne Trockner	
422004N	John Deere	Schlepper / 4000-4955	4650	0	443	364	32			
422070N	John Deere	Schlepper / 4000-4955	4650	0	560	515	76		ohne Trockner	
452014N	John Deere	Schlepper / 4000-4955	4720	0	362	381	22			MIU10003
422070N	John Deere	Schlepper / 4000-4955	4755	0	560	515	76		ohne Trockner	
422070N	John Deere	Schlepper / 4000-4955	4760	0	560	515	76		ohne Trockner	
422003N	John Deere	Schlepper / 4000-4955	4840	0	447	356	31			
422004N	John Deere	Schlepper / 4000-4955	4850	0	443	364	32			

Dasis Nr.	Hersteller	Modell	Typ	KW	Netzlänge [mm]	Netzbreite [mm]	Netztiefe [mm]	Netzmaße	mit / ohne Trockner	für OE-Nummer
422073N	John Deere	Schlepper / 4000-4955	4850	0	660	585	76		ohne Trockner	
422073N	John Deere	Schlepper / 4000-4955	4955	0	660	585	76		ohne Trockner	
422073N	John Deere	Schlepper / 4000-4955	4960	0	660	585	76		ohne Trockner	
452020N	John Deere	Schlepper / 5000-5820	5076E	0	445	457	57			RE229585
452020N	John Deere	Schlepper / 5000-5820	5082E	0	445	457	57			RE229585
452020N	John Deere	Schlepper / 5000-5820	5083E	0	445	457	57			RE229585
452020N	John Deere	Schlepper / 5000-5820	5090E	0	445	457	57			RE229585
452020N	John Deere	Schlepper / 5000-5820	5093E	0	445	457	57			RE229585
452020N	John Deere	Schlepper / 5000-5820	5101E	0	445	457	57			RE229585
452020N	John Deere	Schlepper / 5000-5820	5225	0	445	457	57			RE229585
452020N	John Deere	Schlepper / 5000-5820	5325	0	445	457	57			RE229585
452020N	John Deere	Schlepper / 5000-5820	5425	0	445	457	57			RE229585
452020N	John Deere	Schlepper / 5000-5820	5525	0	445	457	57			RE229585
452020N	John Deere	Schlepper / 5000-5820	5625	0	445	457	57			RE229585
420014N	John Deere	Schlepper / 6000-6930	6010	0	400	510	67			
420033N	John Deere	Schlepper / 6000-6930	6020	0	443	460	26			
420033N	John Deere	Schlepper / 6000-6930	6020SE	0	443	460	26			
420014N	John Deere	Schlepper / 6000-6930	6100	0	400	510	67			
420014N	John Deere	Schlepper / 6000-6930	6110	0	400	510	67			
420014N	John Deere	Schlepper / 6000-6930	6120	0	400	510	67			
420033N	John Deere	Schlepper / 6000-6930	6120	0	443	460	26			
420014N	John Deere	Schlepper / 6000-6930	6200	0	400	510	67			
420014N	John Deere	Schlepper / 6000-6930	6210	0	400	510	67			
420033N	John Deere	Schlepper / 6000-6930	6210SE	0	443	460	26			
420033N	John Deere	Schlepper / 6000-6930	6220	0	443	460	26			
420033N	John Deere	Schlepper / 6000-6930	6220SE	0	443	460	26			
420014N	John Deere	Schlepper / 6000-6930	6300	0	400	510	67			
420014N	John Deere	Schlepper / 6000-6930	6310	0	400	510	67			
420033N	John Deere	Schlepper / 6000-6930	6320	0	443	460	26			
420033N	John Deere	Schlepper / 6000-6930	6320SE	0	443	460	26			

Dasis Nr.	Hersteller	Modell	Typ	KW	Netzlänge [mm]	Netzbreite [mm]	Netztiefe [mm]	Netzmaße	mit / ohne Trockner	für OE-Nummer
420014N	John Deere	Schlepper / 6000-6930	6400	0	400	510	67			
420014N	John Deere	Schlepper / 6000-6930	6410	0	400	510	67			
420033N	John Deere	Schlepper / 6000-6930	6420	0	443	460	26			
420033N	John Deere	Schlepper / 6000-6930	6420S	0	443	460	26			
420033N	John Deere	Schlepper / 6000-6930	6420SE	0	443	460	26			
420019N	John Deere	Schlepper / 6000-6930	6506	0	580	405	65			AL119567
420019N	John Deere	Schlepper / 6000-6930	6510	0	580	405	65			AL119567
420033N	John Deere	Schlepper / 6000-6930	6520	0	443	460	26			
420033N	John Deere	Schlepper / 6000-6930	6520SE	0	443	460	26			
420019N	John Deere	Schlepper / 6000-6930	6600	0	580	405	65			AL119567
420019N	John Deere	Schlepper / 6000-6930	6610	0	580	405	65			AL119567
420033N	John Deere	Schlepper / 6000-6930	6620	0	443	460	26			
420019N	John Deere	Schlepper / 6000-6930	6800	0	580	405	65			AL119567
420019N	John Deere	Schlepper / 6000-6930	6810	0	580	405	65			AL119567
420033N	John Deere	Schlepper / 6000-6930	6820	0	443	460	26			
420019N	John Deere	Schlepper / 6000-6930	6900	0	580	405	65			AL119567
420019N	John Deere	Schlepper / 6000-6930	6910	0	580	405	65			AL119567
420019N	John Deere	Schlepper / 6000-6930	6910S	0	580	405	65			AL119567
420033N	John Deere	Schlepper / 6000-6930	6920	0	443	460	26			
420033N	John Deere	Schlepper / 6000-6930	6920S	0	443	460	26			
422020N	John Deere	Schlepper / 8000-8640	8120	0						RE218194 RE222984
422020N	John Deere	Schlepper / 8000-8640	8220	0						RE218194 RE222984
452023N	John Deere	Schlepper / 8000-8640	8235R	0	978	298	35		ohne Trockner	RE297792
452023N	John Deere	Schlepper / 8000-8640	8260R	0	978	298	35		ohne Trockner	RE297792
452023N	John Deere	Schlepper / 8000-8640	8285R	0	978	298	35		ohne Trockner	RE297792
452023N	John Deere	Schlepper / 8000-8640	8310R	0	978	298	35		ohne Trockner	RE297792
422020N	John Deere	Schlepper / 8000-8640	8320	0						RE218194 RE222984
452023N	John Deere	Schlepper / 8000-8640	8335R	0	978	298	35		ohne Trockner	RE297792
452023N	John Deere	Schlepper / 8000-8640	8335RT	0	978	298	35		ohne Trockner	RE297792

Dasis Nr.	Hersteller	Modell	Typ	KW	Netzlänge [mm]	Netzbreite [mm]	Netztiefe [mm]	Netzmaße	mit / ohne Trockner	für OE-Nummer
452023N	John Deere	Schlepper / 8000-8640	8360R	0	978	298	35		ohne Trockner	RE297792
452023N	John Deere	Schlepper / 8000-8640	8360RT	0	978	298	35		ohne Trockner	RE297792
422020N	John Deere	Schlepper / 8000-8640	8420	0						RE218194 RE222984
422003N	John Deere	Schlepper / 8000-8640	8440	0	447	356	31			
422020N	John Deere	Schlepper / 8000-8640	8520	0						RE218194 RE222984
422003N	John Deere	Schlepper / 8000-8640	8640	0	447	356	31			
422023N	John Deere	Schlepper / 9000-9620	9100	0						
422023N	John Deere	Schlepper / 9000-9620	9200	0						
422023N	John Deere	Schlepper / 9000-9620	9300	0						
452023N	John Deere	Schlepper / 9000-9620	9360R	0	978	298	35		ohne Trockner	RE297792
452023N	John Deere	Schlepper / 9000-9620	9370R	0	978	298	35		ohne Trockner	RE297792
422023N	John Deere	Schlepper / 9000-9620	9400	0						
452023N	John Deere	Schlepper / 9000-9620	9410R	0	978	298	35		ohne Trockner	RE297792
452023N	John Deere	Schlepper / 9000-9620	9420R	0	978	298	35		ohne Trockner	RE297792
452023N	John Deere	Schlepper / 9000-9620	9460R	0	978	298	35		ohne Trockner	RE297792
452023N	John Deere	Schlepper / 9000-9620	9460RT	0	978	298	35		ohne Trockner	RE297792
452023N	John Deere	Schlepper / 9000-9620	9470R	0	978	298	35		ohne Trockner	RE297792
452023N	John Deere	Schlepper / 9000-9620	9470RT	0	978	298	35		ohne Trockner	RE297792
452023N	John Deere	Schlepper / 9000-9620	9470RX	0	978	298	35		ohne Trockner	RE297792
452023N	John Deere	Schlepper / 9000-9620	9510R	0	978	298	35		ohne Trockner	RE297792
452023N	John Deere	Schlepper / 9000-9620	9510RT	0	978	298	35		ohne Trockner	RE297792
452023N	John Deere	Schlepper / 9000-9620	9520R	0	978	298	35		ohne Trockner	RE297792
452023N	John Deere	Schlepper / 9000-9620	9520RT	0	978	298	35		ohne Trockner	RE297792
452023N	John Deere	Schlepper / 9000-9620	9520RX	0	978	298	35		ohne Trockner	RE297792

Dasis Nr.	Hersteller	Modell	Typ	KW	Netzlänge [mm]	Netzbreite [mm]	Netztiefe [mm]	Netzmaße	mit / ohne Trockner	für OE-Nummer
452023N	John Deere	Schlepper / 9000-9620	9560R	0	978	298	35		ohne Trockner	RE297792
452023N	John Deere	Schlepper / 9000-9620	9560RT	0	978	298	35		ohne Trockner	RE297792
452023N	John Deere	Schlepper / 9000-9620	9570R	0	978	298	35		ohne Trockner	RE297792
452023N	John Deere	Schlepper / 9000-9620	9570RT	0	978	298	35		ohne Trockner	RE297792
452023N	John Deere	Schlepper / 9000-9620	9570RX	0	978	298	35		ohne Trockner	RE297792
452005N	John Deere	Schlepper / CTS	9400	0	848	578	132		ohne Trockner	
452005N	John Deere	Schlepper / CTS	9500	0	848	578	132		ohne Trockner	
452005N	John Deere	Schlepper / CTS	9600	0	848	578	132		ohne Trockner	
422020N	John Deere	Selbstfahrende Feldspritze	4920	0						RE218194 RE222984
442014N	Kobelco	Blade Runner	ED150	0						87575958 YN20M01675P1
442014N	Kobelco	Blade Runner	ED195-8	0						87575958 YN20M01675P1
442014N	Kobelco	Kettenbagger	140SR	0						87575958 YN20M01675P1
442014N	Kobelco	Kettenbagger / Sk	140SRLC	0						87575958 YN20M01675P1
442014N	Kobelco	Kettenbagger / Sk	170-8	0						87575958 YN20M01675P1
442014N	Kobelco	Kettenbagger / Sk	210-8	0						87575958 YN20M01675P1
442014N	Kobelco	Kettenbagger / Sk	210LC-8	0						87575958 YN20M01675P1
442014N	Kobelco	Kettenbagger / Sk	215SRLC	0						87575958 YN20M01675P1
442014N	Kobelco	Kettenbagger / Sk	235SRLC-2	0						87575958 YN20M01675P1
442014N	Kobelco	Kettenbagger / Sk	295-8	0						87575958 YN20M01675P1
442014N	Kobelco	Kettenbagger / Sk	350-8	0						87575958 YN20M01675P1
422100N	Kramer Tremo	TELESKOPLADER / KT	307	0	425	430	40			0013004300
422100N	Kramer Tremo	TELESKOPLADER / KT	357	0	425	430	40			0013004300

Dasis Nr.	Hersteller	Modell	Typ	KW	Netzlänge [mm]	Netzbreite [mm]	Netztiefe [mm]	Netzmaße	mit / ohne Trockner	für OE-Nummer
422100N	Kramer Tremo	TELESKOPLADER / KT	447	0	425	430	40			0013004300
422100N	Kramer Tremo	TELESKOPLADER / KT	507	0	425	430	40			0013004300
452010N	Kubota	Bagger KX Serie	KX080-3	0	346	362	16			T1065-72220
452010N	Kubota	Bagger KX Serie	KX121	0	346	362	16			T1065-72220
452010N	Kubota	Bagger KX Serie	KX121-3	0	346	362	16			T1065-72220
452010N	Kubota	Bagger KX Serie	KX161-3	0	346	362	16			T1065-72220
420051N	Landini	Mähdrescher / Rex	75V	0						
420051N	Landini	Mähdrescher / Rex	85V	0						
420051N	Landini	Mähdrescher / Rex	90GT	0						
420051N	Landini	Mähdrescher / Rex	95F	0						
420046N	Landini	Schlepper / Mythos	90	0						
420046N	Landini	Schlepper / Mythos	100	0						
420046N	Landini	Schlepper / Mythos	110	0						
422010N	Massey Ferguson	Mähdrescher / 3400-9790	7250	0	635	400	65		ohne Trockner	
422010N	Massey Ferguson	Mähdrescher / 3400-9790	7252	0	635	400	65		ohne Trockner	
422010N	Massey Ferguson	Mähdrescher / 3400-9790	7254	0	635	400	65		ohne Trockner	
422010N	Massey Ferguson	Mähdrescher / 3400-9790	7256	0	635	400	65		ohne Trockner	
422010N	Massey Ferguson	Mähdrescher / 3400-9790	7272	0	635	400	65		ohne Trockner	
422010N	Massey Ferguson	Mähdrescher / 3400-9790	7274	0	635	400	65		ohne Trockner	
422010N	Massey Ferguson	Mähdrescher / 3400-9790	7276	0	635	400	65		ohne Trockner	
422010N	Massey Ferguson	Mähdrescher / 3400-9790	7278	0	635	400	65		ohne Trockner	
422010N	Massey Ferguson	Mähdrescher / MF 24-40	24	0	635	400	65		ohne Trockner	
422010N	Massey Ferguson	Mähdrescher / MF 24-40	29XP	0	635	400	65		ohne Trockner	
422010N	Massey Ferguson	Mähdrescher / MF 24-40	30	0	635	400	65		ohne Trockner	
422010N	Massey Ferguson	Mähdrescher / MF 24-40	31XP	0	635	400	65		ohne Trockner	



Dasis Nr.	Hersteller	Modell	Typ	KW	Netzlänge [mm]	Netzbreite [mm]	Netztiefe [mm]	Netzmaße	mit / ohne Trockner	für OE-Nummer
422010N	Massey Ferguson	Mähdrescher / MF 24-40	32	0	635	400	65		ohne Trockner	
422010N	Massey Ferguson	Mähdrescher / MF 24-40	34	0	635	400	65		ohne Trockner	
422010N	Massey Ferguson	Mähdrescher / MF 24-40	36	0	635	400	65		ohne Trockner	
422010N	Massey Ferguson	Mähdrescher / MF 24-40	38	0	635	400	65		ohne Trockner	
422010N	Massey Ferguson	Mähdrescher / MF 24-40	40	0	635	400	65		ohne Trockner	
422018N	Massey Ferguson	MF 5400	5425	0						4290397M2
422019N	Massey Ferguson	MF 5400	5425	0						4292069M2
422018N	Massey Ferguson	MF 5400	5435	0						4290397M2
422019N	Massey Ferguson	MF 5400	5435	0						4292069M2
422018N	Massey Ferguson	MF 5400	5445	0						4290397M2
422019N	Massey Ferguson	MF 5400	5445	0						4292069M2
422018N	Massey Ferguson	MF 5400	5455	0						4290397M2
422019N	Massey Ferguson	MF 5400	5455	0						4292069M2
422022N	Massey Ferguson	MF 6600	6612	0						
422022N	Massey Ferguson	MF 6600	6613	0						
422022N	Massey Ferguson	MF 6600	6614	0						
422022N	Massey Ferguson	MF 6600	6615	0						
422022N	Massey Ferguson	MF 6600	6616	0						
422022N	Massey Ferguson	MF 7600	7614	0						
422022N	Massey Ferguson	MF 7600	7615	0						
422022N	Massey Ferguson	MF 7600	7616	0						
422022N	Massey Ferguson	MF 7600	7618	0						
422022N	Massey Ferguson	MF 7600	7619	0						
422022N	Massey Ferguson	MF 7600	7620	0						
422022N	Massey Ferguson	MF 7600	7622	0						
422022N	Massey Ferguson	MF 7600	7624	0						
422022N	Massey Ferguson	MF 7600	7626	0						
422018N	Massey Ferguson	MF 8600	8650	0						4290397M2
422018N	Massey Ferguson	MF 8600	8660	0						4290397M2

Dasis Nr.	Hersteller	Modell	Typ	KW	Netzlänge [mm]	Netzbreite [mm]	Netztiefe [mm]	Netzmaße	mit / ohne Trockner	für OE-Nummer
422018N	Massey Ferguson	MF 8600	8670	0						4290397M2
422018N	Massey Ferguson	MF 8600	8680	0						4290397M2
422018N	Massey Ferguson	MF 8600	8690	0						4290397M2
422027N	Massey Ferguson	MF 8700	8727	176	440	405	16			
422027N	Massey Ferguson	MF 8700	8730	195	440	405	16			
422027N	Massey Ferguson	MF 8700	8732	213	440	405	16			
422027N	Massey Ferguson	MF 8700	8735	235	440	405	16			
422027N	Massey Ferguson	MF 8700	8737	250	440	405	16			
422007N	Massey Ferguson	Schlepper / 2000	2620	0	58,5	28,5	2,5			
422007N	Massey Ferguson	Schlepper / 2000	2625	0	58,5	28,5	2,5			
422007N	Massey Ferguson	Schlepper / 2000	2640	0	58,5	28,5	2,5			
422007N	Massey Ferguson	Schlepper / 2000	2645	0	58,5	28,5	2,5			
422007N	Massey Ferguson	Schlepper / 2000	2675	0	58,5	28,5	2,5			
422007N	Massey Ferguson	Schlepper / 2000	2680	0	58,5	28,5	2,5			
422007N	Massey Ferguson	Schlepper / 2000	2685	0	58,5	28,5	2,5			
422007N	Massey Ferguson	Schlepper / 2000	2705	0	58,5	28,5	2,5			
422007N	Massey Ferguson	Schlepper / 2000	2720	0	58,5	28,5	2,5			
422007N	Massey Ferguson	Schlepper / 2000	2725	0	58,5	28,5	2,5			
422007N	Massey Ferguson	Schlepper / 2000	2775	0	58,5	28,5	2,5			
420017N	Massey Ferguson	Schlepper / 3000	3050	0						
422009N	Massey Ferguson	Schlepper / 3000	3050	0	500	360	38			
420018N	Massey Ferguson	Schlepper / 3000	3050	0	550	360	93			
420017N	Massey Ferguson	Schlepper / 3000	3060	0						
422009N	Massey Ferguson	Schlepper / 3000	3060	0	500	360	38			
420018N	Massey Ferguson	Schlepper / 3000	3060	0	550	360	93			
420017N	Massey Ferguson	Schlepper / 3000	3065	0						
422009N	Massey Ferguson	Schlepper / 3000	3065	0	500	360	38			
420018N	Massey Ferguson	Schlepper / 3000	3065	0	550	360	93			
420017N	Massey Ferguson	Schlepper / 3000	3070	0						
422009N	Massey Ferguson	Schlepper / 3000	3070	0	500	360	38			
420018N	Massey Ferguson	Schlepper / 3000	3070	0	550	360	93			

Dasis Nr.	Hersteller	Modell	Typ	KW	Netzlänge [mm]	Netzbreite [mm]	Netztiefe [mm]	Netzmaße	mit / ohne Trockner	für OE-Nummer
420017N	Massey Ferguson	Schlepper / 3000	3075	0						
422009N	Massey Ferguson	Schlepper / 3000	3075	0	500	360	38			
420018N	Massey Ferguson	Schlepper / 3000	3075	0	550	360	93			
420017N	Massey Ferguson	Schlepper / 3000	3080	0						
422009N	Massey Ferguson	Schlepper / 3000	3080	0	500	360	38			
420018N	Massey Ferguson	Schlepper / 3000	3080	0	550	360	93			
420017N	Massey Ferguson	Schlepper / 3000	3085	0						
422009N	Massey Ferguson	Schlepper / 3000	3085	0	500	360	38			
420018N	Massey Ferguson	Schlepper / 3000	3085	0	550	360	93			
420017N	Massey Ferguson	Schlepper / 3000	3090	0						
422009N	Massey Ferguson	Schlepper / 3000	3090	0	500	360	38			
420018N	Massey Ferguson	Schlepper / 3000	3090	0	550	360	93			
420017N	Massey Ferguson	Schlepper / 3000	3095	0						
422009N	Massey Ferguson	Schlepper / 3000	3095	0	500	360	38			
420018N	Massey Ferguson	Schlepper / 3000	3095	0	550	360	93			
422009N	Massey Ferguson	Schlepper / 3000	3115	0	500	360	38			
420018N	Massey Ferguson	Schlepper / 3000	3115	0	550	360	93			
422009N	Massey Ferguson	Schlepper / 3000	3120	0	500	360	38			
420018N	Massey Ferguson	Schlepper / 3000	3120	0	550	360	93			
422009N	Massey Ferguson	Schlepper / 3000	3120T	0	500	360	38			
420018N	Massey Ferguson	Schlepper / 3000	3120T	0	550	360	93			
422009N	Massey Ferguson	Schlepper / 3000	3125	0	500	360	38			
420018N	Massey Ferguson	Schlepper / 3000	3125	0	550	360	93			
422009N	Massey Ferguson	Schlepper / 3000	3140	0	500	360	38			
420018N	Massey Ferguson	Schlepper / 3000	3140	0	550	360	93			
422007N	Massey Ferguson	Schlepper / 3000	3505	0	58,5	28,5	2,5			
422007N	Massey Ferguson	Schlepper / 3000	3525	0	58,5	28,5	2,5			
422007N	Massey Ferguson	Schlepper / 3000	3545	0	58,5	28,5	2,5			
422007N	Massey Ferguson	Schlepper / 3000	3610	0	58,5	28,5	2,5			
422030N	Massey Ferguson	Schlepper / 3000	3615	0						
422030N	Massey Ferguson	Schlepper / 3000	3625	0						

Dasis Nr.	Hersteller	Modell	Typ	KW	Netzlänge [mm]	Netzbreite [mm]	Netztiefe [mm]	Netzmaße	mit / ohne Trockner	für OE-Nummer
422030N	Massey Ferguson	Schlepper / 3000	3630	0						
422007N	Massey Ferguson	Schlepper / 3000	3630	0	58,5	28,5	2,5			
422030N	Massey Ferguson	Schlepper / 3000	3635	0						
422009N	Massey Ferguson	Schlepper / 3000	3635	0	500	360	38			
422030N	Massey Ferguson	Schlepper / 3000	3640	0						
422009N	Massey Ferguson	Schlepper / 3000	3645	0	500	360	38			
422030N	Massey Ferguson	Schlepper / 3000	3650	0						
422007N	Massey Ferguson	Schlepper / 3000	3650	0	58,5	28,5	2,5			
422009N	Massey Ferguson	Schlepper / 3000	3650	0	500	360	38			
422007N	Massey Ferguson	Schlepper / 3000	3660	0	58,5	28,5	2,5			
422007N	Massey Ferguson	Schlepper / 3000	3670	0	58,5	28,5	2,5			
422007N	Massey Ferguson	Schlepper / 3000	3680	0	58,5	28,5	2,5			
422007N	Massey Ferguson	Schlepper / 3000	3690	0	58,5	28,5	2,5			
420022N	Massey Ferguson	Schlepper / 4000	4215	0						
420021N	Massey Ferguson	Schlepper / 4000	4215	0						
420021N	Massey Ferguson	Schlepper / 4000	4220	0						
420022N	Massey Ferguson	Schlepper / 4000	4220	0						
420022N	Massey Ferguson	Schlepper / 4000	4225	0						
420021N	Massey Ferguson	Schlepper / 4000	4225	0						
420040N	Massey Ferguson	Schlepper / 4000	4225	0	575	310	65			
420022N	Massey Ferguson	Schlepper / 4000	4235	0						
420021N	Massey Ferguson	Schlepper / 4000	4235	0						
420040N	Massey Ferguson	Schlepper / 4000	4235	0	575	310	65			
420022N	Massey Ferguson	Schlepper / 4000	4240	0						
420021N	Massey Ferguson	Schlepper / 4000	4240	0						
420040N	Massey Ferguson	Schlepper / 4000	4240	0	575	310	65			
420022N	Massey Ferguson	Schlepper / 4000	4243	0						
420021N	Massey Ferguson	Schlepper / 4000	4243	0						
420021N	Massey Ferguson	Schlepper / 4000	4245	0						
420022N	Massey Ferguson	Schlepper / 4000	4245	0						
420040N	Massey Ferguson	Schlepper / 4000	4245	0	575	310	65			

Dasis Nr.	Hersteller	Modell	Typ	KW	Netzlänge [mm]	Netzbreite [mm]	Netztiefe [mm]	Netzmaße	mit / ohne Trockner	für OE-Nummer
420021N	Massey Ferguson	Schlepper / 4000	4255	0						
420022N	Massey Ferguson	Schlepper / 4000	4255	0						
420040N	Massey Ferguson	Schlepper / 4000	4255	0	575	310	65			
420021N	Massey Ferguson	Schlepper / 4000	4260	0						
420022N	Massey Ferguson	Schlepper / 4000	4260	0						
420040N	Massey Ferguson	Schlepper / 4000	4260	0	575	310	65			
420022N	Massey Ferguson	Schlepper / 4000	4263	0						
420021N	Massey Ferguson	Schlepper / 4000	4263	0						
420021N	Massey Ferguson	Schlepper / 4000	4265	0						
420022N	Massey Ferguson	Schlepper / 4000	4265	0						
420022N	Massey Ferguson	Schlepper / 4000	4270	0						
420021N	Massey Ferguson	Schlepper / 4000	4270	0						
420040N	Massey Ferguson	Schlepper / 4000	4270	0	575	310	65			
420021N	Massey Ferguson	Schlepper / 4000	4315	0						
420021N	Massey Ferguson	Schlepper / 4000	4320	0						
420021N	Massey Ferguson	Schlepper / 4000	4325	0						
420040N	Massey Ferguson	Schlepper / 4000	4325	0	575	310	65			
420021N	Massey Ferguson	Schlepper / 4000	4335	0						
420040N	Massey Ferguson	Schlepper / 4000	4335	0	575	310	65			
420021N	Massey Ferguson	Schlepper / 4000	4345	0						
420040N	Massey Ferguson	Schlepper / 4000	4345	0	575	310	65			
420021N	Massey Ferguson	Schlepper / 4000	4355	0						
420040N	Massey Ferguson	Schlepper / 4000	4355	0	575	310	65			
420021N	Massey Ferguson	Schlepper / 4000	4360	0						
420021N	Massey Ferguson	Schlepper / 4000	4370	0						
422028N	Massey Ferguson	Schlepper / 5000	5410	0						
422028N	Massey Ferguson	Schlepper / 5000	5420	0						
420024N	Massey Ferguson	Schlepper / 5000	5425	0	490	260	55			3778577M1
420040N	Massey Ferguson	Schlepper / 5000	5425	0	575	310	65			
422028N	Massey Ferguson	Schlepper / 5000	5430	0						
420024N	Massey Ferguson	Schlepper / 5000	5435	0	490	260	55			3778577M1

Dasis Nr.	Hersteller	Modell	Typ	KW	Netzlänge [mm]	Netzbreite [mm]	Netztiefe [mm]	Netzmaße	mit / ohne Trockner	für OE-Nummer
420040N	Massey Ferguson	Schlepper / 5000	5435	0	575	310	65			
422028N	Massey Ferguson	Schlepper / 5000	5440	0						
422028N	Massey Ferguson	Schlepper / 5000	5445	0						
420024N	Massey Ferguson	Schlepper / 5000	5445	0	490	260	55			3778577M1
420040N	Massey Ferguson	Schlepper / 5000	5445	0	575	310	65			
422028N	Massey Ferguson	Schlepper / 5000	5450	0						
422028N	Massey Ferguson	Schlepper / 5000	5455	0						
420024N	Massey Ferguson	Schlepper / 5000	5455	0	490	260	55			3778577M1
420040N	Massey Ferguson	Schlepper / 5000	5455	0	575	310	65			
420024N	Massey Ferguson	Schlepper / 5000	5460	0	490	260	55			3778577M1
420040N	Massey Ferguson	Schlepper / 5000	5460	0	575	310	65			
420024N	Massey Ferguson	Schlepper / 5000	5465	0	490	260	55			3778577M1
420024N	Massey Ferguson	Schlepper / 5000	5465 HI-Visibility	0	490	260	55			3778577M1
420024N	Massey Ferguson	Schlepper / 5000	5470	0	490	260	55			3778577M1
420040N	Massey Ferguson	Schlepper / 5000	5470	0	575	310	65			
420024N	Massey Ferguson	Schlepper / 5000	5480	0	490	260	55			3778577M1
420040N	Massey Ferguson	Schlepper / 5000	5480	0	575	310	65			
422009N	Massey Ferguson	Schlepper / 6000	6110	0	500	360	38			
422009N	Massey Ferguson	Schlepper / 6000	6120	0	500	360	38			
422009N	Massey Ferguson	Schlepper / 6000	6130	0	500	360	38			
422009N	Massey Ferguson	Schlepper / 6000	6140	0	500	360	38			
422009N	Massey Ferguson	Schlepper / 6000	6150	0	500	360	38			
422009N	Massey Ferguson	Schlepper / 6000	6160	0	500	360	38			
422009N	Massey Ferguson	Schlepper / 6000	6170	0	500	360	38			
422009N	Massey Ferguson	Schlepper / 6000	6180	0	500	360	38			
422009N	Massey Ferguson	Schlepper / 6000	6190	0	500	360	38			
420024N	Massey Ferguson	Schlepper / 6000	6235	0	490	260	55			3778577M1
420040N	Massey Ferguson	Schlepper / 6000	6235	0	575	310	65			
420024N	Massey Ferguson	Schlepper / 6000	6245	0	490	260	55			3778577M1
420040N	Massey Ferguson	Schlepper / 6000	6245	0	575	310	65			
420024N	Massey Ferguson	Schlepper / 6000	6255	0	490	260	55			3778577M1

Dasis Nr.	Hersteller	Modell	Typ	KW	Netzlänge [mm]	Netzbreite [mm]	Netztiefe [mm]	Netzmaße	mit / ohne Trockner	für OE-Nummer
420040N	Massey Ferguson	Schlepper / 6000	6255	0	575	310	65			
420024N	Massey Ferguson	Schlepper / 6000	6260	0	490	260	55			3778577M1
420040N	Massey Ferguson	Schlepper / 6000	6260	0	575	310	65			
420024N	Massey Ferguson	Schlepper / 6000	6265	0	490	260	55			3778577M1
420040N	Massey Ferguson	Schlepper / 6000	6265	0	575	310	65			
420024N	Massey Ferguson	Schlepper / 6000	6270	0	490	260	55			3778577M1
420040N	Massey Ferguson	Schlepper / 6000	6270	0	575	310	65			
420024N	Massey Ferguson	Schlepper / 6000	6280	0	490	260	55			3778577M1
420040N	Massey Ferguson	Schlepper / 6000	6280	0	575	310	65			
420024N	Massey Ferguson	Schlepper / 6000	6290	0	490	260	55			3778577M1
420040N	Massey Ferguson	Schlepper / 6000	6290	0	575	310	65			
420015N	Massey Ferguson	Schlepper / 6000	6465	0	385	540	60			
420015N	Massey Ferguson	Schlepper / 6000	6475	0	385	540	60			
420015N	Massey Ferguson	Schlepper / 6000	6480	0	385	540	60			
420015N	Massey Ferguson	Schlepper / 6000	6485	0	385	540	60			
420015N	Massey Ferguson	Schlepper / 6000	6490	0	385	540	60			
420015N	Massey Ferguson	Schlepper / 6000	6495	0	385	540	60			
420015N	Massey Ferguson	Schlepper / 7000	7465	0	385	540	60			
420015N	Massey Ferguson	Schlepper / 7000	7475	0	385	540	60			
420015N	Massey Ferguson	Schlepper / 7000	7480	0	385	540	60			
420015N	Massey Ferguson	Schlepper / 7000	7485	0	385	540	60			
420015N	Massey Ferguson	Schlepper / 7000	7490	0	385	540	60			
420015N	Massey Ferguson	Schlepper / 7000	7495	0	385	540	60			
420015N	Massey Ferguson	Schlepper / 7000	7495Räder3	0	385	540	60			
422009N	Massey Ferguson	Schlepper / 8000	8110	0	500	360	38			
422009N	Massey Ferguson	Schlepper / 8000	8120	0	500	360	38			
422009N	Massey Ferguson	Schlepper / 8000	8130	0	500	360	38			
422009N	Massey Ferguson	Schlepper / 8000	8140	0	500	360	38			
422009N	Massey Ferguson	Schlepper / 8000	8150	0	500	360	38			
422009N	Massey Ferguson	Schlepper / 8000	8160	0	500	360	38			
422009N	Massey Ferguson	Schlepper / 8000	8170	0	500	360	38			

Dasis Nr.	Hersteller	Modell	Typ	KW	Netzlänge [mm]	Netzbreite [mm]	Netztiefe [mm]	Netzmaße	mit / ohne Trockner	für OE-Nummer
422009N	Massey Ferguson	Schlepper / 8000	8180	0	500	360	38			
422010N	Massey Ferguson	Schlepper / Dronningborg	24	0	635	400	65		ohne Trockner	
422010N	Massey Ferguson	Schlepper / Dronningborg	29P	0	635	400	65		ohne Trockner	
422010N	Massey Ferguson	Schlepper / Dronningborg	30	0	635	400	65		ohne Trockner	
422010N	Massey Ferguson	Schlepper / Dronningborg	31P	0	635	400	65		ohne Trockner	
422010N	Massey Ferguson	Schlepper / Dronningborg	32	0	635	400	65		ohne Trockner	
422010N	Massey Ferguson	Schlepper / Dronningborg	34	0	635	400	65		ohne Trockner	
422010N	Massey Ferguson	Schlepper / Dronningborg	36	0	635	400	65		ohne Trockner	
422010N	Massey Ferguson	Schlepper / Dronningborg	38	0	635	400	65		ohne Trockner	
422010N	Massey Ferguson	Schlepper / Dronningborg	40	0	635	400	65		ohne Trockner	
452002N	Massey Ferguson	Teleskoplader / 9000	9305	0					ohne Trockner	
452002N	Massey Ferguson	Teleskoplader / 9000	9306	0					ohne Trockner	
452002N	Massey Ferguson	Teleskoplader / 9000	9407	0					ohne Trockner	
452002N	Massey Ferguson	Teleskoplader / 9000	9407S	0					ohne Trockner	
442014N	NEW HOLLAND	Baggerlader / E Serie	135B	0						87575958 YN20M01675P1
442014N	NEW HOLLAND	Baggerlader / E Serie	135BSR	0						87575958 YN20M01675P1
442014N	NEW HOLLAND	Baggerlader / E Serie	150BSR	0						87575958 YN20M01675P1
442014N	NEW HOLLAND	Baggerlader / E Serie	175B	0						87575958 YN20M01675P1
442014N	NEW HOLLAND	Baggerlader / E Serie	195B	0						87575958 YN20M01675P1
442014N	NEW HOLLAND	Baggerlader / E Serie	215B	0						87575958 YN20M01675P1
442014N	NEW HOLLAND	Baggerlader / E Serie	215B-C	0						87575958 YN20M01675P1
442014N	NEW HOLLAND	Baggerlader / E Serie	215BJ	0						87575958 YN20M01675P1



Dasis Nr.	Hersteller	Modell	Typ	KW	Netzlänge [mm]	Netzbreite [mm]	Netztiefe [mm]	Netzmaße	mit / ohne Trockner	für OE-Nummer
442014N	NEW HOLLAND	Baggerlader / E Serie	225BSR	0						87575958 YN20M01675P1
442014N	NEW HOLLAND	Baggerlader / E Serie	225BSRLC	0						87575958 YN20M01675P1
442014N	NEW HOLLAND	Baggerlader / E Serie	235BSR	0						87575958 YN20M01675P1
442014N	NEW HOLLAND	Baggerlader / E Serie	235BSRLC	0						87575958 YN20M01675P1
442014N	NEW HOLLAND	Baggerlader / E Serie	235BSRNLC	0						87575958 YN20M01675P1
442014N	NEW HOLLAND	Baggerlader / E Serie	245B	0						87575958 YN20M01675P1
442014N	NEW HOLLAND	Baggerlader / E Serie	265B	0						87575958 YN20M01675P1
442014N	NEW HOLLAND	Baggerlader / E Serie	265B-C	0						87575958 YN20M01675P1
442014N	NEW HOLLAND	Baggerlader / E Serie	265BJ	0						87575958 YN20M01675P1
442014N	NEW HOLLAND	Baggerlader / E Serie	265BSR	0						87575958 YN20M01675P1
442014N	NEW HOLLAND	Baggerlader / E Serie	265C	0						87575958 YN20M01675P1
442014N	NEW HOLLAND	Baggerlader / E Serie	305B	0						87575958 YN20M01675P1
442014N	NEW HOLLAND	Baggerlader / E Serie	305B-C	0						87575958 YN20M01675P1
442014N	NEW HOLLAND	Baggerlader / E Serie	305C	0						87575958 YN20M01675P1
442014N	NEW HOLLAND	Baggerlader / E Serie	385B	0						87575958 YN20M01675P1
442014N	NEW HOLLAND	Baggerlader / E Serie	385B-C	0						87575958 YN20M01675P1
442014N	NEW HOLLAND	Baggerlader / E Serie	485B	0						87575958 YN20M01675P1
422008N	NEW HOLLAND	Mähdrescher / 8000	8030	0	680	250	60			
422008N	NEW HOLLAND	Mähdrescher / 8000	8040	0	680	250	60			
422008N	NEW HOLLAND	Mähdrescher / 8000	8050	0	680	250	60			
422008N	NEW HOLLAND	Mähdrescher / 8000	8055	0	680	250	60			
422008N	NEW HOLLAND	Mähdrescher / 8000	8060	0	680	250	60			
422008N	NEW HOLLAND	Mähdrescher / 8000	8070	0	680	250	60			
422008N	NEW HOLLAND	Mähdrescher / 8000	8080	0	680	250	60			

Dasis Nr.	Hersteller	Modell	Typ	KW	Netzlänge [mm]	Netzbreite [mm]	Netztiefe [mm]	Netzmaße	mit / ohne Trockner	für OE-Nummer
422043N	NEW HOLLAND	Mähdrescher / CR	920	0	1010	610	44		ohne Trockner	84074560 84439890 87317242 87610364
422043N	NEW HOLLAND	Mähdrescher / CR	940	0	1010	610	44		ohne Trockner	84074560 84439890 87317242 87610364
422043N	NEW HOLLAND	Mähdrescher / CR	960	0	1010	610	44		ohne Trockner	84074560 84439890 87317242 87610364
422043N	NEW HOLLAND	Mähdrescher / CR	970	0	1010	610	44		ohne Trockner	84074560 84439890 87317242 87610364
422043N	NEW HOLLAND	Mähdrescher / CR	980	0	1010	610	44		ohne Trockner	84074560 84439890 87317242 87610364
422043N	NEW HOLLAND	Mähdrescher / CR	9040	0	1010	610	44		ohne Trockner	84074560 84439890 87317242 87610364
422043N	NEW HOLLAND	Mähdrescher / CR	9060	0	1010	610	44		ohne Trockner	84074560 84439890 87317242 87610364
422043N	NEW HOLLAND	Mähdrescher / CR	9065	0	1010	610	44		ohne Trockner	84074560 84439890 87317242 87610364
422043N	NEW HOLLAND	Mähdrescher / CR	9070	0	1010	610	44		ohne Trockner	84074560 84439890 87317242 87610364
422043N	NEW HOLLAND	Mähdrescher / CR	9080	0	1010	610	44		ohne Trockner	84074560 84439890 87317242 87610364
422043N	NEW HOLLAND	Mähdrescher / CR	9090	0	1010	610	44		ohne Trockner	84074560 84439890 87317242 87610364
422043N	NEW HOLLAND	Mähdrescher / CS	520	0	1010	610	44		ohne Trockner	84074560 84439890 87317242 87610364
422043N	NEW HOLLAND	Mähdrescher / CS	540	0	1010	610	44		ohne Trockner	84074560 84439890 87317242 87610364
422043N	NEW HOLLAND	Mähdrescher / CS	640	0	1010	610	44		ohne Trockner	84074560 84439890 87317242 87610364
422043N	NEW HOLLAND	Mähdrescher / CS	660	0	1010	610	44		ohne Trockner	84074560 84439890 87317242 87610364
422043N	NEW HOLLAND	Mähdrescher / CX	720	0	1010	610	44		ohne Trockner	84074560 84439890 87317242 87610364
422043N	NEW HOLLAND	Mähdrescher / CX	740	0	1010	610	44		ohne Trockner	84074560 84439890 87317242 87610364
422043N	NEW HOLLAND	Mähdrescher / CX	760	0	1010	610	44		ohne Trockner	84074560 84439890 87317242 87610364
422043N	NEW HOLLAND	Mähdrescher / CX	780	0	1010	610	44		ohne Trockner	84074560 84439890 87317242 87610364
422043N	NEW HOLLAND	Mähdrescher / CX	820	0	1010	610	44		ohne Trockner	84074560 84439890 87317242 87610364
422043N	NEW HOLLAND	Mähdrescher / CX	840	0	1010	610	44		ohne Trockner	84074560 84439890 87317242 87610364

Dasis Nr.	Hersteller	Modell	Typ	KW	Netzlänge [mm]	Netzbreite [mm]	Netztiefe [mm]	Netzmaße	mit / ohne Trockner	für OE-Nummer
422043N	NEW HOLLAND	Mähdrescher / CX	860	0	1010	610	44		ohne Trockner	84074560 84439890 87317242 87610364
422043N	NEW HOLLAND	Mähdrescher / CX	880	0	1010	610	44		ohne Trockner	84074560 84439890 87317242 87610364
422043N	NEW HOLLAND	Mähdrescher / CX	8030	0	1010	610	44		ohne Trockner	84074560 84439890 87317242 87610364
422043N	NEW HOLLAND	Mähdrescher / CX	8040	0	1010	610	44		ohne Trockner	84074560 84439890 87317242 87610364
422043N	NEW HOLLAND	Mähdrescher / CX	8050	0	1010	610	44		ohne Trockner	84074560 84439890 87317242 87610364
422043N	NEW HOLLAND	Mähdrescher / CX	8060	0	1010	610	44		ohne Trockner	84074560 84439890 87317242 87610364
422043N	NEW HOLLAND	Mähdrescher / CX	8070	0	1010	610	44		ohne Trockner	84074560 84439890 87317242 87610364
422043N	NEW HOLLAND	Mähdrescher / CX	8080	0	1010	610	44		ohne Trockner	84074560 84439890 87317242 87610364
422043N	NEW HOLLAND	Mähdrescher / CX	8090	0	1010	610	44		ohne Trockner	84074560 84439890 87317242 87610364
422043N	NEW HOLLAND	Mähdrescher / FR / Forage	9040	0	1010	610	44		ohne Trockner	84074560 84439890 87317242 87610364
422043N	NEW HOLLAND	Mähdrescher / FR / Forage	9050	0	1010	610	44		ohne Trockner	84074560 84439890 87317242 87610364
422043N	NEW HOLLAND	Mähdrescher / FR / Forage	9060	0	1010	610	44		ohne Trockner	84074560 84439890 87317242 87610364
422043N	NEW HOLLAND	Mähdrescher / FR / Forage	9080	0	1010	610	44		ohne Trockner	84074560 84439890 87317242 87610364
422043N	NEW HOLLAND	Mähdrescher / FR / Forage	9090	0	1010	610	44		ohne Trockner	84074560 84439890 87317242 87610364
422043N	NEW HOLLAND	Mähdrescher / FX	28	0	1010	610	44		ohne Trockner	84074560 84439890 87317242 87610364
422043N	NEW HOLLAND	Mähdrescher / FX	30	0	1010	610	44		ohne Trockner	84074560 84439890 87317242 87610364
422043N	NEW HOLLAND	Mähdrescher / FX	38	0	1010	610	44		ohne Trockner	84074560 84439890 87317242 87610364
422043N	NEW HOLLAND	Mähdrescher / FX	40	0	1010	610	44		ohne Trockner	84074560 84439890 87317242 87610364
422043N	NEW HOLLAND	Mähdrescher / FX	48	0	1010	610	44		ohne Trockner	84074560 84439890 87317242 87610364
422043N	NEW HOLLAND	Mähdrescher / FX	50	0	1010	610	44		ohne Trockner	84074560 84439890 87317242 87610364
422011N	NEW HOLLAND	Mähdrescher / TF	42	0					ohne Trockner	

Dasis Nr.	Hersteller	Modell	Typ	KW	Netzlänge [mm]	Netzbreite [mm]	Netztiefe [mm]	Netzmaße	mit / ohne Trockner	für OE-Nummer
422011N	NEW HOLLAND	Mähdrescher / TF	44	0					ohne Trockner	
422011N	NEW HOLLAND	Mähdrescher / TF	46	0					ohne Trockner	
422055N	NEW HOLLAND	Mähdrescher / TX	62	0	292	508	70		ohne Trockner	84021139 84026459 89850813 9850813
422055N	NEW HOLLAND	Mähdrescher / TX	64	0	292	508	70		ohne Trockner	84021139 84026459 89850813 9850813
422055N	NEW HOLLAND	Mähdrescher / TX	65	0	292	508	70		ohne Trockner	84021139 84026459 89850813 9850813
422055N	NEW HOLLAND	Mähdrescher / TX	66	0	292	508	70		ohne Trockner	84021139 84026459 89850813 9850813
422055N	NEW HOLLAND	Mähdrescher / TX	67	0	292	508	70		ohne Trockner	84021139 84026459 89850813 9850813
422055N	NEW HOLLAND	Mähdrescher / TX	68	0	292	508	70		ohne Trockner	84021139 84026459 89850813 9850813
442005N	NEW HOLLAND	Schlepper	Diverse	0	341	427	22			
442004N	NEW HOLLAND	Schlepper	Diverse	0	351	403	22			
422012N	NEW HOLLAND	Schlepper / 3435-7635	3435	0	490	406	51		ohne Trockner	
422012N	NEW HOLLAND	Schlepper / 3435-7635	3935	0	490	406	51		ohne Trockner	
422012N	NEW HOLLAND	Schlepper / 3435-7635	4135	0	490	406	51		ohne Trockner	
422012N	NEW HOLLAND	Schlepper / 3435-7635	4635	0	490	406	51		ohne Trockner	
422012N	NEW HOLLAND	Schlepper / 3435-7635	4835	0	490	406	51		ohne Trockner	
422012N	NEW HOLLAND	Schlepper / 3435-7635	5635	0	490	406	51		ohne Trockner	
422012N	NEW HOLLAND	Schlepper / 3435-7635	6635	0	490	406	51		ohne Trockner	
422012N	NEW HOLLAND	Schlepper / 3435-7635	7635	0	490	406	51		ohne Trockner	
422013N	NEW HOLLAND	Schlepper / 4140-8340	5640	0	455	305	66			65217010
422013N	NEW HOLLAND	Schlepper / 4140-8340	6640	0	455	305	66			65217010
422013N	NEW HOLLAND	Schlepper / 4140-8340	7740	0	455	305	66			65217010
422013N	NEW HOLLAND	Schlepper / 4140-8340	7840	0	455	305	66			65217010
422013N	NEW HOLLAND	Schlepper / 4140-8340	8240	0	455	305	66			65217010
422013N	NEW HOLLAND	Schlepper / 4140-8340	8340	0	455	305	66			65217010

Dasis Nr.	Hersteller	Modell	Typ	KW	Netzlänge [mm]	Netzbreite [mm]	Netztiefe [mm]	Netzmaße	mit / ohne Trockner	für OE-Nummer
422014N	NEW HOLLAND	Schlepper / 8160-8560	8160	0	515	385	125		ohne Trockner	82007142
422014N	NEW HOLLAND	Schlepper / 8160-8560	8260	0	515	385	125		ohne Trockner	82007142
422014N	NEW HOLLAND	Schlepper / 8160-8560	8360	0	515	385	125		ohne Trockner	82007142
422014N	NEW HOLLAND	Schlepper / 8160-8560	8560	0	515	385	125		ohne Trockner	82007142
452007N	NEW HOLLAND	Schlepper / T9 Serie	9.390	0	790	290	70		ohne Trockner	
452007N	NEW HOLLAND	Schlepper / T9 Serie	9.450	0	790	290	70		ohne Trockner	
452007N	NEW HOLLAND	Schlepper / T9 Serie	9.505	0	790	290	70		ohne Trockner	
452007N	NEW HOLLAND	Schlepper / T9 Serie	9.560	0	790	290	70		ohne Trockner	
442008N	NEW HOLLAND	Schlepper / TD	75D Räder 2	0	315	391	22			
442007N	NEW HOLLAND	Schlepper / TD	75 Räder 3	0	351	391	22			
442008N	NEW HOLLAND	Schlepper / TD	80D	0	315	391	22			
442007N	NEW HOLLAND	Schlepper / TD	80 Räder 3	0	351	391	22			
442008N	NEW HOLLAND	Schlepper / TD	85D Räder 2	0	315	391	22			
442007N	NEW HOLLAND	Schlepper / TD	85 Räder 3	0	351	391	22			
442007N	NEW HOLLAND	Schlepper / TD	90 Räder 3	0	351	391	22			
442008N	NEW HOLLAND	Schlepper / TD	95D Räder 2	0	315	391	22			
442008N	NEW HOLLAND	Schlepper / TD	110	0	315	391	22			
422040N	NEW HOLLAND	Schlepper / TL	70	0	476	533	44		ohne Trockner	47132050
422012N	NEW HOLLAND	Schlepper / TL	70	0	490	406	51		ohne Trockner	
422040N	NEW HOLLAND	Schlepper / TL	80	0	476	533	44		ohne Trockner	47132050
422012N	NEW HOLLAND	Schlepper / TL	80	0	490	406	51		ohne Trockner	
422040N	NEW HOLLAND	Schlepper / TL	90	0	476	533	44		ohne Trockner	47132050
422012N	NEW HOLLAND	Schlepper / TL	90	0	490	406	51		ohne Trockner	
422040N	NEW HOLLAND	Schlepper / TL	100	0	476	533	44		ohne Trockner	47132050

Dasis Nr.	Hersteller	Modell	Typ	KW	Netzlänge [mm]	Netzbreite [mm]	Netztiefe [mm]	Netzmaße	mit / ohne Trockner	für OE-Nummer
422012N	NEW HOLLAND	Schlepper / TL	100	0	490	406	51		ohne Trockner	
422014N	NEW HOLLAND	Schlepper / TM	TM115	0	515	385	125		ohne Trockner	82007142
422014N	NEW HOLLAND	Schlepper / TM	TM120	0	515	385	125		ohne Trockner	82007142
422014N	NEW HOLLAND	Schlepper / TM	TM125	0	515	385	125		ohne Trockner	82007142
422014N	NEW HOLLAND	Schlepper / TM	TM130	0	515	385	125		ohne Trockner	82007142
422014N	NEW HOLLAND	Schlepper / TM	TM135	0	515	385	125		ohne Trockner	82007142
422014N	NEW HOLLAND	Schlepper / TM	TM140	0	515	385	125		ohne Trockner	82007142
422014N	NEW HOLLAND	Schlepper / TM	TM150	0	515	385	125		ohne Trockner	82007142
422014N	NEW HOLLAND	Schlepper / TM	TM155	0	515	385	125		ohne Trockner	82007142
422014N	NEW HOLLAND	Schlepper / TM	TM165	0	515	385	125		ohne Trockner	82007142
422014N	NEW HOLLAND	Schlepper / TM	TM175	0	515	385	125		ohne Trockner	82007142
422014N	NEW HOLLAND	Schlepper / TM	TM190	0	515	385	125		ohne Trockner	82007142
452015N	NEW HOLLAND	Schlepper / TN	55V	0	495	380	25		ohne Trockner	5192341 9971626
452015N	NEW HOLLAND	Schlepper / TN	65F	0	495	380	25		ohne Trockner	5192341 9971626
452015N	NEW HOLLAND	Schlepper / TN	65N	0	495	380	25		ohne Trockner	5192341 9971626
452015N	NEW HOLLAND	Schlepper / TN	65V	0	495	380	25		ohne Trockner	5192341 9971626
452015N	NEW HOLLAND	Schlepper / TN	75F	0	495	380	25		ohne Trockner	5192341 9971626
452015N	NEW HOLLAND	Schlepper / TN	75N	0	495	380	25		ohne Trockner	5192341 9971626
452015N	NEW HOLLAND	Schlepper / TN	75V	0	495	380	25		ohne Trockner	5192341 9971626
452015N	NEW HOLLAND	Schlepper / TN	90F	0	495	380	25		ohne Trockner	5192341 9971626
422013N	NEW HOLLAND	Schlepper / TS	80	0	455	305	66			65217010
422013N	NEW HOLLAND	Schlepper / TS	90	0	455	305	66			65217010

Dasis Nr.	Hersteller	Modell	Typ	KW	Netzlänge [mm]	Netzbreite [mm]	Netztiefe [mm]	Netzmaße	mit / ohne Trockner	für OE-Nummer
422013N	NEW HOLLAND	Schlepper / TS	100	0	455	305	66			65217010
422013N	NEW HOLLAND	Schlepper / TS	110	0	455	305	66			65217010
422013N	NEW HOLLAND	Schlepper / TS	115	0	455	305	66			65217010
420044N	NEW HOLLAND	Schlepper / TW	10	0						
420044N	NEW HOLLAND	Schlepper / TW	20	0						
420044N	NEW HOLLAND	Schlepper / TW	30	0						
420044N	NEW HOLLAND	Schlepper / TW5	5	0						
420044N	NEW HOLLAND	Schlepper / TW5	15	0						
420044N	NEW HOLLAND	Schlepper / TW5	25	0						
420044N	NEW HOLLAND	Schlepper / TW5	35	0						
420044N	NEW HOLLAND	Schlepper Wein Obst / TW	5	0						
420044N	NEW HOLLAND	Schlepper Wein Obst / TW	25	0						
420044N	NEW HOLLAND	Schlepper Wein Obst / TW	30	0						
420044N	NEW HOLLAND	Schlepper Wein Obst / TW	35	0						
422088N	Renault	Schlepper / Ares 500	546 RX/RZ	0	440	440	50	440x440x50		7700059987
422088N	Renault	Schlepper / Ares 500	556 RX/RZ	0	440	440	50	440x440x50		7700059987
422088N	Renault	Schlepper / Ares 500	566 RX/RZ	0	440	440	50	440x440x50		7700059987
422088N	Renault	Schlepper / Ares 600	616 RX/RZ	0	440	440	50	440x440x50		7700059987
422088N	Renault	Schlepper / Ares 600	626 RX/RZ	0	440	440	50	440x440x50		7700059987
422088N	Renault	Schlepper / Ares 600	656 RZ	0	440	440	50	440x440x50		7700059987
422088N	Renault	Schlepper / Ares 600	696 RZ	0	440	440	50	440x440x50		7700059987
420038N	Renault	Schlepper / Ares 700	710	0						
420038N	Renault	Schlepper / Ares 700	715	0						
420038N	Renault	Schlepper / Ares 700	720	0						
420038N	Renault	Schlepper / Ares 700	725	0						
420038N	Renault	Schlepper / Ares 700	735	0						
420038N	Renault	Schlepper / Ares 800	815	0						
420038N	Renault	Schlepper / Ares 800	816	0						
420038N	Renault	Schlepper / Ares 800	825	0						
420038N	Renault	Schlepper / Ares 800	826	0						

Dasis Nr.	Hersteller	Modell	Typ	KW	Netzlänge [mm]	Netzbreite [mm]	Netztiefe [mm]	Netzmaße	mit / ohne Trockner	für OE-Nummer
420038N	Renault	Schlepper / Ares 800	836	0						
420038N	Renault	Schlepper / Atlas	915	0						
420038N	Renault	Schlepper / Atlas	925	0						
420038N	Renault	Schlepper / Atlas	926	0						
420038N	Renault	Schlepper / Atlas	935	0						
420038N	Renault	Schlepper / Atlas	936	0						
420037N	Renault	Schlepper / Ceres	65	0						
420037N	Renault	Schlepper / Ceres	65-4	0						
420037N	Renault	Schlepper / Ceres	70-70	0						
420037N	Renault	Schlepper / Ceres	70-70-4	0						
420037N	Renault	Schlepper / Ceres	75-75	0						
420037N	Renault	Schlepper / Ceres	75-75-4	0						
420037N	Renault	Schlepper / Ceres	85-85	0						
420037N	Renault	Schlepper / Ceres	85-85-4	0						
420037N	Renault	Schlepper / Ceres	95-95	0						
420037N	Renault	Schlepper / Ceres	95-95-4	0						
420043N	Renault	Schlepper / Ceres	310	0	465	432	38		ohne Trockner	7700055950
420043N	Renault	Schlepper / Ceres	320	0	465	432	38		ohne Trockner	7700055950
420043N	Renault	Schlepper / Ceres	325	0	465	432	38		ohne Trockner	7700055950
420035N	Renault	Schlepper / Ceres	330	0						
420037N	Renault	Schlepper / Ceres	330	0						
420043N	Renault	Schlepper / Ceres	330	0	465	432	38		ohne Trockner	7700055950
420035N	Renault	Schlepper / Ceres	335	0						
420037N	Renault	Schlepper / Ceres	335	0						
420043N	Renault	Schlepper / Ceres	335	0	465	432	38		ohne Trockner	7700055950
420035N	Renault	Schlepper / Ceres	340	0						
420037N	Renault	Schlepper / Ceres	340	0						
420043N	Renault	Schlepper / Ceres	340	0	465	432	38		ohne Trockner	7700055950
420035N	Renault	Schlepper / Ceres	345	0						



Dasis Nr.	Hersteller	Modell	Typ	KW	Netzlänge [mm]	Netzbreite [mm]	Netztiefe [mm]	Netzmaße	mit / ohne Trockner	für OE-Nummer
420037N	Renault	Schlepper / Ceres	345	0						
420043N	Renault	Schlepper / Ceres	345	0	465	432	38		ohne Trockner	7700055950
420037N	Renault	Schlepper / Ceres	355	0						
420035N	Renault	Schlepper / Ceres	355	0						
420043N	Renault	Schlepper / Ceres	355	0	465	432	38		ohne Trockner	7700055950
420037N	Renault	Schlepper / Cergos	330	0						
420035N	Renault	Schlepper / Cergos	330	0						
420043N	Renault	Schlepper / Cergos	330	0	465	432	38		ohne Trockner	7700055950
420037N	Renault	Schlepper / Cergos	335	0						
420035N	Renault	Schlepper / Cergos	335	0						
420043N	Renault	Schlepper / Cergos	335	0	465	432	38		ohne Trockner	7700055950
420035N	Renault	Schlepper / Cergos	340	0						
420037N	Renault	Schlepper / Cergos	340	0						
420043N	Renault	Schlepper / Cergos	340	0	465	432	38		ohne Trockner	7700055950
420035N	Renault	Schlepper / Cergos	345	0						
420037N	Renault	Schlepper / Cergos	345	0						
420043N	Renault	Schlepper / Cergos	345	0	465	432	38		ohne Trockner	7700055950
420037N	Renault	Schlepper / Cergos	350	0						
420035N	Renault	Schlepper / Cergos	350	0						
420043N	Renault	Schlepper / Cergos	350	0	465	432	38		ohne Trockner	7700055950
420037N	Renault	Schlepper / Cergos	355	0						
420035N	Renault	Schlepper / Cergos	355	0						
420043N	Renault	Schlepper / Cergos	355	0	465	432	38		ohne Trockner	7700055950
420039N	Renault	Schlepper / LB	50-12	0						
420039N	Renault	Schlepper / LB	55-12	0						
420039N	Renault	Schlepper / LB	55-14	0						
420039N	Renault	Schlepper / LB	70-12	0						
420039N	Renault	Schlepper / LB	70-14	0						

Dasis Nr.	Hersteller	Modell	Typ	KW	Netzlänge [mm]	Netzbreite [mm]	Netztiefe [mm]	Netzmaße	mit / ohne Trockner	für OE-Nummer
422006N	Renault	Schlepper / ME	58-32ME	0	515	560	43		ohne Trockner	
422006N	Renault	Schlepper / ME	58-34ME	0	515	560	43		ohne Trockner	
422006N	Renault	Schlepper / ME	65-32ME	0	515	560	43		ohne Trockner	
422006N	Renault	Schlepper / ME	65-34ME	0	515	560	43		ohne Trockner	
422006N	Renault	Schlepper / ME	75-12ME	0	515	560	43		ohne Trockner	
422006N	Renault	Schlepper / ME	75-32ME	0	515	560	43		ohne Trockner	
422006N	Renault	Schlepper / ME	75-34ME	0	515	560	43		ohne Trockner	
422006N	Renault	Schlepper / ME	85-32ME	0	515	560	43		ohne Trockner	
422006N	Renault	Schlepper / ME	85-34ME	0	515	560	43		ohne Trockner	
422006N	Renault	Schlepper / ME	90-32ME	0	515	560	43		ohne Trockner	
422006N	Renault	Schlepper / ME	90-34ME	0	515	560	43		ohne Trockner	
422006N	Renault	Schlepper / ME	110-14ME	0	515	560	43		ohne Trockner	
422006N	Renault	Schlepper / ME	120-14ME	0	515	560	43		ohne Trockner	
422006N	Renault	Schlepper / ME	133-14ME	0	515	560	43		ohne Trockner	
422006N	Renault	Schlepper / ME	145-14ME	0	515	560	43		ohne Trockner	
422006N	Renault	Schlepper / RE	95-12RE	0	515	560	43		ohne Trockner	
422006N	Renault	Schlepper / RE	95-14RE	0	515	560	43		ohne Trockner	
422006N	Renault	Schlepper / RE	103-12RE	0	515	560	43		ohne Trockner	
422006N	Renault	Schlepper / RE	103-14RE	0	515	560	43		ohne Trockner	
422006N	Renault	Schlepper / RE	110-14RE	0	515	560	43		ohne Trockner	
422006N	Renault	Schlepper / RE	113-12RE	0	515	560	43		ohne Trockner	

Dasis Nr.	Hersteller	Modell	Typ	KW	Netzlänge [mm]	Netzbreite [mm]	Netztiefe [mm]	Netzmaße	mit / ohne Trockner	für OE-Nummer
422006N	Renault	Schlepper / RE	113-14RE	0	515	560	43		ohne Trockner	
422006N	Renault	Schlepper / RE	120-14RE	0	515	560	43		ohne Trockner	
422006N	Renault	Schlepper / RE	133-14RE	0	515	560	43		ohne Trockner	
422006N	Renault	Schlepper / RE	145-14RE	0	515	560	43		ohne Trockner	
422006N	Renault	Schlepper / TA	103-52	0	515	560	43		ohne Trockner	
422006N	Renault	Schlepper / TA	103-54	0	515	560	43		ohne Trockner	
422006N	Renault	Schlepper / TA	110-14	0	515	560	43		ohne Trockner	
422006N	Renault	Schlepper / TA	110-54	0	515	560	43		ohne Trockner	
422006N	Renault	Schlepper / TA	120-14	0	515	560	43		ohne Trockner	
422006N	Renault	Schlepper / TA	120-54	0	515	560	43		ohne Trockner	
422006N	Renault	Schlepper / TA	133-14	0	515	560	43		ohne Trockner	
422006N	Renault	Schlepper / TA	133-54	0	515	560	43		ohne Trockner	
422006N	Renault	Schlepper / TA	145-14	0	515	560	43		ohne Trockner	
422006N	Renault	Schlepper / TA	145-54	0	515	560	43		ohne Trockner	
422006N	Renault	Schlepper / TA	155-54	0	515	560	43		ohne Trockner	
422006N	Renault	Schlepper / TE	103-52TE	0	515	560	43		ohne Trockner	
422006N	Renault	Schlepper / TE	103-54TE	0	515	560	43		ohne Trockner	
422006N	Renault	Schlepper / TE	110-14TE	0	515	560	43		ohne Trockner	
422006N	Renault	Schlepper / TE	110-54TE	0	515	560	43		ohne Trockner	
422006N	Renault	Schlepper / TE	120-14TE	0	515	560	43		ohne Trockner	
422006N	Renault	Schlepper / TE	120-54TE	0	515	560	43		ohne Trockner	

Dasis Nr.	Hersteller	Modell	Typ	KW	Netzlänge [mm]	Netzbreite [mm]	Netztiefe [mm]	Netzmaße	mit / ohne Trockner	für OE-Nummer
422006N	Renault	Schlepper / TE	133-14TE	0	515	560	43		ohne Trockner	
422006N	Renault	Schlepper / TE	133-54TE	0	515	560	43		ohne Trockner	
422006N	Renault	Schlepper / TE	145-14TE	0	515	560	43		ohne Trockner	
422006N	Renault	Schlepper / TE	145-54TE	0	515	560	43		ohne Trockner	
422006N	Renault	Schlepper / TE	155-54TE	0	515	560	43		ohne Trockner	
422088N	Renault	Schlepper / Temis	610	0	440	440	50	440x440x50		7700059987
422088N	Renault	Schlepper / Temis	630	0	440	440	50	440x440x50		7700059987
422088N	Renault	Schlepper / Temis	650	0	440	440	50	440x440x50		7700059987
422006N	Renault	Schlepper / TS	75-12	0	515	560	43		ohne Trockner	
422006N	Renault	Schlepper / TS	75-14	0	515	560	43		ohne Trockner	
422006N	Renault	Schlepper / TS	77-12	0	515	560	43		ohne Trockner	
422006N	Renault	Schlepper / TS	77-14	0	515	560	43		ohne Trockner	
422006N	Renault	Schlepper / TS	85-12	0	515	560	43		ohne Trockner	
422006N	Renault	Schlepper / TS	85-14	0	515	560	43		ohne Trockner	
422006N	Renault	Schlepper / TS	95-12	0	515	560	43		ohne Trockner	
422006N	Renault	Schlepper / TS	95-14	0	515	560	43		ohne Trockner	
422006N	Renault	Schlepper / TS	103-12	0	515	560	43		ohne Trockner	
422006N	Renault	Schlepper / TS	103-14	0	515	560	43		ohne Trockner	
422006N	Renault	Schlepper / TS	103-52	0	515	560	43		ohne Trockner	
422006N	Renault	Schlepper / TS	103-54	0	515	560	43		ohne Trockner	
422006N	Renault	Schlepper / TS	106-54	0	515	560	43		ohne Trockner	
422006N	Renault	Schlepper / TS	110-14	0	515	560	43		ohne Trockner	

Dasis Nr.	Hersteller	Modell	Typ	KW	Netzlänge [mm]	Netzbreite [mm]	Netztiefe [mm]	Netzmaße	mit / ohne Trockner	für OE-Nummer
422006N	Renault	Schlepper / TS	110-54	0	515	560	43		ohne Trockner	
422006N	Renault	Schlepper / TS	113-12	0	515	560	43		ohne Trockner	
422006N	Renault	Schlepper / TS	113-14	0	515	560	43		ohne Trockner	
422006N	Renault	Schlepper / TS	120-14	0	515	560	43		ohne Trockner	
422006N	Renault	Schlepper / TS	120-54	0	515	560	43		ohne Trockner	
422006N	Renault	Schlepper / TS	133-12	0	515	560	43		ohne Trockner	
422006N	Renault	Schlepper / TS	133-14	0	515	560	43		ohne Trockner	
422006N	Renault	Schlepper / TS	133-54	0	515	560	43		ohne Trockner	
422006N	Renault	Schlepper / TX	75-32TX	0	515	560	43		ohne Trockner	
422006N	Renault	Schlepper / TX	75-34TX	0	515	560	43		ohne Trockner	
422006N	Renault	Schlepper / TX	80-12TX	0	515	560	43		ohne Trockner	
422006N	Renault	Schlepper / TX	80-14TX	0	515	560	43		ohne Trockner	
422006N	Renault	Schlepper / TX	85-12TX	0	515	560	43		ohne Trockner	
422006N	Renault	Schlepper / TX	85-14TX	0	515	560	43		ohne Trockner	
422006N	Renault	Schlepper / TX	85-32TX	0	515	560	43		ohne Trockner	
422006N	Renault	Schlepper / TX	85-34TX	0	515	560	43		ohne Trockner	
422006N	Renault	Schlepper / TX	90-32TX	0	515	560	43		ohne Trockner	
422006N	Renault	Schlepper / TX	90-34TX	0	515	560	43		ohne Trockner	
422006N	Renault	Schlepper / TX	95-12TX	0	515	560	43		ohne Trockner	
422006N	Renault	Schlepper / TX	95-14TX	0	515	560	43		ohne Trockner	
422006N	Renault	Schlepper / TX	103-12TX	0	515	560	43		ohne Trockner	

Dasis Nr.	Hersteller	Modell	Typ	KW	Netzlänge [mm]	Netzbreite [mm]	Netztiefe [mm]	Netzmaße	mit / ohne Trockner	für OE-Nummer
422006N	Renault	Schlepper / TX	103-14TX	0	515	560	43		ohne Trockner	
422006N	Renault	Schlepper / TX	103-52TX	0	515	560	43		ohne Trockner	
422006N	Renault	Schlepper / TX	103-54TX	0	515	560	43		ohne Trockner	
422006N	Renault	Schlepper / TX	106-54TX	0	515	560	43		ohne Trockner	
422006N	Renault	Schlepper / TX	110-14TX	0	515	560	43		ohne Trockner	
422006N	Renault	Schlepper / TX	110-54TX	0	515	560	43		ohne Trockner	
422006N	Renault	Schlepper / TX	113-12TX	0	515	560	43		ohne Trockner	
422006N	Renault	Schlepper / TX	113-14TX	0	515	560	43		ohne Trockner	
422006N	Renault	Schlepper / TX	120-14TX	0	515	560	43		ohne Trockner	
422006N	Renault	Schlepper / TX	133-12TX	0	515	560	43		ohne Trockner	
422006N	Renault	Schlepper / TX	133-14TX	0	515	560	43		ohne Trockner	
422006N	Renault	Schlepper / TX	133-54TX	0	515	560	43		ohne Trockner	
422006N	Renault	Schlepper / TX	145-14TX	0	515	560	43		ohne Trockner	
422006N	Renault	Schlepper / TX	145-54TX	0	515	560	43		ohne Trockner	
422006N	Renault	Schlepper / TZ	110-54TZ	0	515	560	43		ohne Trockner	
422006N	Renault	Schlepper / TZ	120-14TZ	0	515	560	43		ohne Trockner	
422006N	Renault	Schlepper / TZ	120-54TZ	0	515	560	43		ohne Trockner	
422006N	Renault	Schlepper / TZ	133-14TZ	0	515	560	43		ohne Trockner	
422006N	Renault	Schlepper / TZ	133-54TZ	0	515	560	43		ohne Trockner	
422006N	Renault	Schlepper / TZ	145-14TZ	0	515	560	43		ohne Trockner	
422006N	Renault	Schlepper / TZ	145-54TZ	0	515	560	43		ohne Trockner	

Dasis Nr.	Hersteller	Modell	Typ	KW	Netzlänge [mm]	Netzbreite [mm]	Netztiefe [mm]	Netzmaße	mit / ohne Trockner	für OE-Nummer
422006N	Renault	Schlepper / TZ	155-54TZ	0	515	560	43		ohne Trockner	
420017N	Renault	Schlepper / V	55-12	0						
420017N	Renault	Schlepper / V	55-14	0						
420017N	Renault	Schlepper / V	70-12	0						
420017N	Renault	Schlepper / V	70-14	0						
420017N	Renault	Schlepper / V	80-12	0						
420017N	Renault	Schlepper / V	80-14	0						
420039N	Renault	Schlepper Obst Wein / Dionis	110	0						
420039N	Renault	Schlepper Obst Wein / Dionis	120	0						
420039N	Renault	Schlepper Obst Wein / Dionis	130	0						
420039N	Renault	Schlepper Obst Wein / Dionis	140	0						
420017N	Renault	Schlepper Obst Wein / F	32-50F	0						
420017N	Renault	Schlepper Obst Wein / F	32-60F	0						
420017N	Renault	Schlepper Obst Wein / F	42-70F	0						
420017N	Renault	Schlepper Obst Wein / F	44-70F	0						
420017N	Renault	Schlepper Obst Wein / F	55-12F	0						
420017N	Renault	Schlepper Obst Wein / F	70-12F	0						
420017N	Renault	Schlepper Obst Wein / F	70-14F	0						
420017N	Renault	Schlepper Obst Wein / F	80-12F	0						
420017N	Renault	Schlepper Obst Wein / F	80-14F	0						
420039N	Renault	Schlepper Obst Wein / Fructus	110	0						
420039N	Renault	Schlepper Obst Wein / Fructus	120	0						
420039N	Renault	Schlepper Obst Wein / Fructus	130	0						
420039N	Renault	Schlepper Obst Wein / Fructus	140	0						
422006N	Renault	Schlepper Obst Wein / TZ	160-94	0	515	560	43		ohne Trockner	
422006N	Renault	Schlepper Obst Wein / TZ	175-74	0	515	560	43		ohne Trockner	

Dasis Nr.	Hersteller	Modell	Typ	KW	Netzlänge [mm]	Netzbreite [mm]	Netztiefe [mm]	Netzmaße	mit / ohne Trockner	für OE-Nummer
422006N	Renault	Schlepper Obst Wein / TZ	180-94	0	515	560	43		ohne Trockner	
420017N	Renault	Schlepper Obst Wein / V	32-50V	0						
420017N	Renault	Schlepper Obst Wein / V	32-60V	0						
420017N	Renault	Schlepper Obst Wein / V	34-60V	0						
420017N	Renault	Schlepper Obst Wein / V	42-70V	0						
420017N	Renault	Schlepper Obst Wein / V	50-12V	0						
420042N	Steyr	Schlepper / CS	78	0	320	520	70			
420042N	Steyr	Schlepper / CS	86	0	320	520	70			
420042N	Steyr	Schlepper / CS	94	0	320	520	70			
420042N	Steyr	Schlepper / CS	100	0	320	520	70			
420042N	Steyr	Schlepper / CS	110	0	320	520	70			
420042N	Steyr	Schlepper / CS	120	0	320	520	70			
420042N	Steyr	Schlepper / CS	130	0	320	520	70			
420042N	Steyr	Schlepper / CS	150	0	320	520	70			
420023N	Steyr	Schlepper / CVX	V120	0	520	400	32		ohne Trockner	
420023N	Steyr	Schlepper / CVX	V130	0	520	400	32		ohne Trockner	
420023N	Steyr	Schlepper / CVX	V150	0	520	400	32		ohne Trockner	
420023N	Steyr	Schlepper / CVX	V170	0	520	400	32		ohne Trockner	
420023N	Steyr	Schlepper / CVX	V1135	0	520	400	32		ohne Trockner	
420023N	Steyr	Schlepper / CVX	V1145	0	520	400	32		ohne Trockner	
420023N	Steyr	Schlepper / CVX	V1155	0	520	400	32		ohne Trockner	
420023N	Steyr	Schlepper / CVX	V1170	0	520	400	32		ohne Trockner	
420023N	Steyr	Schlepper / CVX	V1190	0	520	400	32		ohne Trockner	
442010N	Tumosan	Schlepper / 8000	T80 8100	0	351	391	22			
420048N	Valtra Valmet	Schlepper / 6000	6000	0						
420048N	Valtra Valmet	Schlepper / 6000	6100	0						
420048N	Valtra Valmet	Schlepper / 6000	6200	0						



Dasis Nr.	Hersteller	Modell	Typ	KW	Netzlänge [mm]	Netzbreite [mm]	Netztiefe [mm]	Netzmaße	mit / ohne Trockner	für OE-Nummer
420048N	Valtra Valmet	Schlepper / 6000	6300	0						
420048N	Valtra Valmet	Schlepper / 6000	6400	0						
420048N	Valtra Valmet	Schlepper / 6000	6600	0						
420048N	Valtra Valmet	Schlepper / 6000	6800	0						
420048N	Valtra Valmet	Schlepper / 6000	6900	0						
420050N	Valtra Valmet	Schlepper / 8000	8000	0						
420050N	Valtra Valmet	Schlepper / 8000	8100	0						
420050N	Valtra Valmet	Schlepper / 8000	8300	0						
420050N	Valtra Valmet	Schlepper / 8000	8600	0						
442011N	Valtra Valmet	Schlepper / N	122	0						
442011N	Valtra Valmet	Schlepper / N	142	0						
422018N	Valtra Valmet	Schlepper / S	262	0						4290397M2
422018N	Valtra Valmet	Schlepper / S	263	0						4290397M2
422018N	Valtra Valmet	Schlepper / S	292	0						4290397M2
422018N	Valtra Valmet	Schlepper / S	293	0						4290397M2
422018N	Valtra Valmet	Schlepper / S	322	0						4290397M2
422018N	Valtra Valmet	Schlepper / S	323	0						4290397M2
422018N	Valtra Valmet	Schlepper / S	352	0						4290397M2
422018N	Valtra Valmet	Schlepper / S	353	0						4290397M2
442012N	Valtra Valmet	Schlepper / T	120	0						
442012N	Valtra Valmet	Schlepper / T	130	0						
420050N	Valtra Valmet	Schlepper / T	130	0						
442011N	Valtra Valmet	Schlepper / T	132	0						
442012N	Valtra Valmet	Schlepper / T	150	0						
442011N	Valtra Valmet	Schlepper / T	152	0						
420050N	Valtra Valmet	Schlepper / T	160	0						
442011N	Valtra Valmet	Schlepper / T	162	0						
442012N	Valtra Valmet	Schlepper / T	170	0						
442011N	Valtra Valmet	Schlepper / T	172	0						
442012N	Valtra Valmet	Schlepper / T	180	0						
420050N	Valtra Valmet	Schlepper / T	180	0						

Dasis Nr.	Hersteller	Modell	Typ	KW	Netzlänge [mm]	Netzbreite [mm]	Netztiefe [mm]	Netzmaße	mit / ohne Trockner	für OE-Nummer
442011N	Valtra Valmet	Schlepper / T	182	0						
442012N	Valtra Valmet	Schlepper / T	190	0						
420050N	Valtra Valmet	Schlepper / T	190	0						
442011N	Valtra Valmet	Schlepper / T	202	0						
442012N	Valtra Valmet	Schlepper / T1	121	0						
442012N	Valtra Valmet	Schlepper / T1	131	0						
442012N	Valtra Valmet	Schlepper / T1	151	0						
442012N	Valtra Valmet	Schlepper / T1	161	0						
442012N	Valtra Valmet	Schlepper / T1	171	0						
442012N	Valtra Valmet	Schlepper / T1	191	0						
442012N	Valtra Valmet	Schlepper / XM	130	0						
442012N	Valtra Valmet	Schlepper / XM	150	0						
420028N	Volvo	Motorgrader / C	A25C	0	550	579	64		ohne Trockner	11104197 11104561 11115414
420028N	Volvo	Motorgrader / C	A30C	0	550	579	64		ohne Trockner	11104197 11104561 11115414
420028N	Volvo	Motorgrader / C	A40C	0	550	579	64		ohne Trockner	11104197 11104561 11115414
420031N	Volvo	Muldenkipper / C	A250	0						
420031N	Volvo	Muldenkipper / C	A300	0						
420031N	Volvo	Muldenkipper / C	A400	0						
420031N	Volvo	Muldenkipper / C	L1200	0						
420031N	Volvo	Schaufellader / C	L1200C	0						
420028N	Volvo	Schaufellader / D	L50D	0	550	579	64		ohne Trockner	11104197 11104561 11115414
420028N	Volvo	Schaufellader / D	L70D	0	550	579	64		ohne Trockner	11104197 11104561 11115414
420028N	Volvo	Schaufellader / D	L90D	0	550	579	64		ohne Trockner	11104197 11104561 11115414
420028N	Volvo	Schaufellader / D	L120D	0	550	579	64		ohne Trockner	11104197 11104561 11115414
420028N	Volvo	Schaufellader / D	L150D	0	550	579	64		ohne Trockner	11104197 11104561 11115414
420028N	Volvo	Schaufellader / E	L60E	0	550	579	64		ohne Trockner	11104197 11104561 11115414
420028N	Volvo	Schaufellader / E	L70E	0	550	579	64		ohne Trockner	11104197 11104561 11115414

Dasis Nr.	Hersteller	Modell	Typ	KW	Netzlänge [mm]	Netzbreite [mm]	Netztiefe [mm]	Netzmaße	mit / ohne Trockner	für OE-Nummer
420028N	Volvo	Schaufellader / E	L90E	0	550	579	64		ohne Trockner	11104197 11104561 11115414
420028N	Volvo	Schaufellader / E	L110E	0	550	579	64		ohne Trockner	11104197 11104561 11115414
420028N	Volvo	Schaufellader / E	L120E	0	550	579	64		ohne Trockner	11104197 11104561 11115414
420028N	Volvo	Schaufellader / E	L150E	0	550	579	64		ohne Trockner	11104197 11104561 11115414
420028N	Volvo	Schaufellader / E	L180E	0	550	579	64		ohne Trockner	11104197 11104561 11115414
420028N	Volvo	Schaufellader / E	L220E	0	550	579	64		ohne Trockner	11104197 11104561 11115414
420028N	Volvo	Schaufellader / E	L330E	0	550	579	64		ohne Trockner	11104197 11104561 11115414
420031N	Volvo	Schaufellader / L	50	0						
420028N	Volvo	Schaufellader / L	50	0	550	579	64		ohne Trockner	11104197 11104561 11115414
420031N	Volvo	Schaufellader / L	70	0						
420028N	Volvo	Schaufellader / L	70	0	550	579	64		ohne Trockner	11104197 11104561 11115414
420031N	Volvo	Schaufellader / L	90	0						
420028N	Volvo	Schaufellader / L	90	0	550	579	64		ohne Trockner	11104197 11104561 11115414
420031N	Volvo	Schaufellader / L	120	0						
420028N	Volvo	Schaufellader / L	120	0	550	579	64		ohne Trockner	11104197 11104561 11115414
420031N	Volvo	Schaufellader / L	150	0						
420028N	Volvo	Schaufellader / L	170	0	550	579	64		ohne Trockner	11104197 11104561 11115414

Dasis Nr.	Hersteller	Modell	Typ	Spezifikation	Spannung [V]	Innendurchmesser [mm]	Außendurchmesser [mm]
870238N	Fendt	Schlepper / Vario	207	Axial 190mm blasend	12	190	210
870238N	Fendt	Schlepper / Vario 200 V/F/P Serie	209 V/F/P	Axial 190mm blasend	12	190	210
870238N	Fendt	Schlepper / Vario 200 V/F/P Serie	208 V/F	Axial 190mm blasend	12	190	210
870238N	Fendt	Schlepper / Vario / TMS	211 P	Axial 190mm blasend	12	190	210
870238N	Fendt	Schlepper / Vario / TMS	211	Axial 190mm blasend	12	190	210
870238N	Fendt	Schlepper / Vario / TMS	210 P	Axial 190mm blasend	12	190	210
870238N	Fendt	Schlepper / Vario / TMS	210	Axial 190mm blasend	12	190	210
870238N	Fendt	Schlepper / Vario 200 V/F/P Serie	210 V/F/P	Axial 190mm blasend	12	190	210
870238N	Fendt	Schlepper / Vario / TMS	209 P	Axial 190mm blasend	12	190	210
870238N	Fendt	Schlepper / Vario / TMS	208	Axial 190mm blasend	12	190	210
870238N	Fendt	Schlepper / Vario / TMS	207	Axial 190mm blasend	12	190	210
870238N	Fendt	Schlepper / Vario	211	Axial 190mm blasend	12	190	210
870238N	Fendt	Schlepper / Vario	210	Axial 190mm blasend	12	190	210
870238N	Fendt	Schlepper / Vario	209	Axial 190mm blasend	12	190	210
870238N	Fendt	Schlepper / Vario	208	Axial 190mm blasend	12	190	210
870238N	Fendt	Schlepper / Vario / TMS	209	Axial 190mm blasend	12	190	210
870238N	Fendt	Schlepper / Vario 200 V/F/P Serie	211 V/F/P	Axial 190mm blasend	12	190	210

Dasis Nr.	Hersteller	Modell	Typ	Spezifikation	Spannung [V]	Einschaltpunkt [°C]	Ausschaltpunkt [°C]	Kapillarrohrlänge [mm]
750005N	Bateman	Selbstfahrende Farbspritze / RB	15	Regler AC		0,5	-3,3	1210
901811N	Bateman	Selbstfahrende Farbspritze / RB	16					
750005N	Bateman	Selbstfahrende Farbspritze / RB	16	Regler AC		0,5	-3,3	1210
901811N	Bateman	Selbstfahrende Farbspritze / RB	25					
750005N	Bateman	Selbstfahrende Farbspritze / RB	25	Regler AC		0,5	-3,3	1210
750005N	Braud NH	Selbstfahrende Farbspritze / SB	33	Regler AC		0,5	-3,3	1210
750013N	Braud NH	Selbstfahrende Farbspritze / SB	33	Regler AC		1	-2	1828
750005N	Braud NH	Selbstfahrende Farbspritze / SB	35	Regler AC		0,5	-3,3	1210
750013N	Braud NH	Selbstfahrende Farbspritze / SB	35	Regler AC		1	-2	1828
750005N	Braud NH	Selbstfahrende Farbspritze / SB	36	Regler AC		0,5	-3,3	1210
750013N	Braud NH	Selbstfahrende Farbspritze / SB	36	Regler AC		1	-2	1828
750005N	Braud NH	Selbstfahrende Farbspritze / SB	52	Regler AC		0,5	-3,3	1210
750013N	Braud NH	Selbstfahrende Farbspritze / SB	52	Regler AC		1	-2	1828
750005N	Braud NH	Selbstfahrende Farbspritze / SB	53	Regler AC		0,5	-3,3	1210
750013N	Braud NH	Selbstfahrende Farbspritze / SB	53	Regler AC		1	-2	1828
750005N	Braud NH	Selbstfahrende Farbspritze / SB	54	Regler AC		0,5	-3,3	1210
750013N	Braud NH	Selbstfahrende Farbspritze / SB	54	Regler AC		1	-2	1828
750005N	Braud NH	Selbstfahrende Farbspritze / SB	55	Regler AC		0,5	-3,3	1210
750013N	Braud NH	Selbstfahrende Farbspritze / SB	55	Regler AC		1	-2	1828
750005N	Braud NH	Selbstfahrende Farbspritze / SB	56	Regler AC		0,5	-3,3	1210
750013N	Braud NH	Selbstfahrende Farbspritze / SB	56	Regler AC		1	-2	1828
750005N	Braud NH	Selbstfahrende Farbspritze / SB	58	Regler AC		0,5	-3,3	1210

Dasis Nr.	Hersteller	Modell	Typ	Spezifikation	Spannung [V]	Einschaltpunkt [°C]	Ausschaltpunkt [°C]	Kapillarrohrlänge [mm]
750013N	Braud NH	Selbstfahrende Farbspritze / SB	58	Regler AC		1	-2	1828
750005N	Braud NH	Selbstfahrende Farbspritze / SB	60	Regler AC		0,5	-3,3	1210
750013N	Braud NH	Selbstfahrende Farbspritze / SB	60	Regler AC		1	-2	1828
750005N	Braud NH	Selbstfahrende Farbspritze / SB	62	Regler AC		0,5	-3,3	1210
750013N	Braud NH	Selbstfahrende Farbspritze / SB	62	Regler AC		1	-2	1828
750005N	Braud NH	Selbstfahrende Farbspritze / SB	64	Regler AC		0,5	-3,3	1210
750013N	Braud NH	Selbstfahrende Farbspritze / SB	64	Regler AC		1	-2	1828
750005N	Braud NH	Selbstfahrende Farbspritze / SB	65	Regler AC		0,5	-3,3	1210
750013N	Braud NH	Selbstfahrende Farbspritze / SB	65	Regler AC		1	-2	1828
750005N	Braud NH	Selbstfahrende Farbspritze / VL	610	Regler AC		0,5	-3,3	1210
750005N	Braud NH	Selbstfahrende Farbspritze / VL	620	Regler AC		0,5	-3,3	1210
750005N	Braud NH	Selbstfahrende Farbspritze / VL	630	Regler AC		0,5	-3,3	1210
750005N	Braud NH	Selbstfahrende Farbspritze / VL	640	Regler AC		0,5	-3,3	1210
750005N	Braud NH	Selbstfahrende Farbspritze / VL	660	Regler AC		0,5	-3,3	1210
750013N	Braud NH	Selbstfahrende Farbspritze / VN	240	Regler AC		1	-2	1828
750013N	Braud NH	Selbstfahrende Farbspritze / VN	260	Regler AC		1	-2	1828
750005N	Case International IHC	Mähdrescher / 14	1420	Regler AC		0,5	-3,3	1210
750005N	Case International IHC	Mähdrescher / 14	1440	Regler AC		0,5	-3,3	1210
750005N	Case International IHC	Mähdrescher / 14	1460	Regler AC		0,5	-3,3	1210
750005N	Case International IHC	Mähdrescher / 14	1470	Regler AC		0,5	-3,3	1210
750005N	Case International IHC	Mähdrescher / 14	1480	Regler AC		0,5	-3,3	1210
750005N	Case International IHC	Mähdrescher / 16	1640E	Regler AC		0,5	-3,3	1210
750005N	Case International IHC	Mähdrescher / 16	1644	Regler AC		0,5	-3,3	1210
750005N	Case International IHC	Mähdrescher / 16	1660	Regler AC		0,5	-3,3	1210
750005N	Case International IHC	Mähdrescher / 16	1660E	Regler AC		0,5	-3,3	1210

Dasis Nr.	Hersteller	Modell	Typ	Spezifikation	Spannung [V]	Einschaltpunkt [°C]	Ausschaltpunkt [°C]	Kapillarrohrlänge [mm]
750005N	Case International IHC	Mähdrescher / 16	1666	Regler AC		0,5	-3,3	1210
750005N	Case International IHC	Mähdrescher / 16	1670	Regler AC		0,5	-3,3	1210
750005N	Case International IHC	Mähdrescher / 16	1680	Regler AC		0,5	-3,3	1210
750005N	Case International IHC	Mähdrescher / 16	1680E	Regler AC		0,5	-3,3	1210
750005N	Case International IHC	Mähdrescher / 16	1688	Regler AC		0,5	-3,3	1210
750005N	Case International IHC	Schlepper / 186-996	385	Regler AC		0,5	-3,3	1210
750005N	Case International IHC	Schlepper / 186-996	395	Regler AC		0,5	-3,3	1210
750005N	Case International IHC	Schlepper / 186-996	485	Regler AC		0,5	-3,3	1210
750005N	Case International IHC	Schlepper / 186-996	495	Regler AC		0,5	-3,3	1210
750005N	Case International IHC	Schlepper / 186-996	585	Regler AC		0,5	-3,3	1210
750005N	Case International IHC	Schlepper / 186-996	595	Regler AC		0,5	-3,3	1210
750005N	Case International IHC	Schlepper / 186-996	685	Regler AC		0,5	-3,3	1210
750005N	Case International IHC	Schlepper / 186-996	695	Regler AC		0,5	-3,3	1210
750005N	Case International IHC	Schlepper / 186-996	785	Regler AC		0,5	-3,3	1210
750005N	Case International IHC	Schlepper / 186-996	786	Regler AC		0,5	-3,3	1210
750005N	Case International IHC	Schlepper / 186-996	795	Regler AC		0,5	-3,3	1210
750005N	Case International IHC	Schlepper / 186-996	856	Regler AC		0,5	-3,3	1210
750005N	Case International IHC	Schlepper / 186-996	885	Regler AC		0,5	-3,3	1210
750005N	Case International IHC	Schlepper / 186-996	886	Regler AC		0,5	-3,3	1210
750005N	Case International IHC	Schlepper / 186-996	895	Regler AC		0,5	-3,3	1210
750005N	Case International IHC	Schlepper / 186-996	955	Regler AC		0,5	-3,3	1210
750005N	Case International IHC	Schlepper / 186-996	956	Regler AC		0,5	-3,3	1210
750005N	Case International IHC	Schlepper / 186-996	985	Regler AC		0,5	-3,3	1210
750005N	Case International IHC	Schlepper / 186-996	986	Regler AC		0,5	-3,3	1210
750005N	Case International IHC	Schlepper / 186-996	995	Regler AC		0,5	-3,3	1210
750005N	Case International IHC	Schlepper / 1046-1896	1055	Regler AC		0,5	-3,3	1210
750005N	Case International IHC	Schlepper / 1046-1896	1056	Regler AC		0,5	-3,3	1210
750005N	Case International IHC	Schlepper / 1046-1896	1086	Regler AC		0,5	-3,3	1210
750005N	Case International IHC	Schlepper / 1046-1896	1255	Regler AC		0,5	-3,3	1210
750005N	Case International IHC	Schlepper / 1046-1896	1455	Regler AC		0,5	-3,3	1210
750005N	Case International IHC	Schlepper / 1046-1896	1486	Regler AC		0,5	-3,3	1210
750005N	Case International IHC	Schlepper / 1046-1896	1586	Regler AC		0,5	-3,3	1210

Dasis Nr.	Hersteller	Modell	Typ	Spezifikation	Spannung [V]	Einschaltpunkt [°C]	Ausschaltpunkt [°C]	Kapillarrohrlänge [mm]
750005N	Case International IHC	Schlepper / 3088-3788	3088	Regler AC		0,5	-3,3	1210
750005N	Case International IHC	Schlepper / 3088-3788	3210	Regler AC		0,5	-3,3	1210
750005N	Case International IHC	Schlepper / 3088-3788	3220	Regler AC		0,5	-3,3	1210
750005N	Case International IHC	Schlepper / 3088-3788	3230	Regler AC		0,5	-3,3	1210
750005N	Case International IHC	Schlepper / 3088-3788	3288	Regler AC		0,5	-3,3	1210
750005N	Case International IHC	Schlepper / 3088-3788	3388	Regler AC		0,5	-3,3	1210
750005N	Case International IHC	Schlepper / 3088-3788	3488	Regler AC		0,5	-3,3	1210
750005N	Case International IHC	Schlepper / 3088-3788	3588	Regler AC		0,5	-3,3	1210
750005N	Case International IHC	Schlepper / 3088-3788	3688	Regler AC		0,5	-3,3	1210
750005N	Case International IHC	Schlepper / 3088-3788	3788	Regler AC		0,5	-3,3	1210
750005N	Case International IHC	Schlepper / 4000-4894	4186	Regler AC		0,5	-3,3	1210
750005N	Case International IHC	Schlepper / 4000-4894	4586	Regler AC		0,5	-3,3	1210
750005N	Case International IHC	Schlepper / 4000-4894	4786	Regler AC		0,5	-3,3	1210
750005N	Case International IHC	Schlepper / 5088-5488	5088	Regler AC		0,5	-3,3	1210
750005N	Case International IHC	Schlepper / 5088-5488	5220	Regler AC		0,5	-3,3	1210
750005N	Case International IHC	Schlepper / 5088-5488	5230	Regler AC		0,5	-3,3	1210
750005N	Case International IHC	Schlepper / 5088-5488	5240	Regler AC		0,5	-3,3	1210
750005N	Case International IHC	Schlepper / 5088-5488	5250	Regler AC		0,5	-3,3	1210
750005N	Case International IHC	Schlepper / 5088-5488	5288	Regler AC		0,5	-3,3	1210
750005N	Case International IHC	Schlepper / 5088-5488	5488	Regler AC		0,5	-3,3	1210
750005N	Case International IHC	Schlepper / 6388-6788	6388	Regler AC		0,5	-3,3	1210
750005N	Case International IHC	Schlepper / 6388-6788	6588	Regler AC		0,5	-3,3	1210
750005N	Case International IHC	Schlepper / 7110-7488	7110E	Regler AC		0,5	-3,3	1210
750005N	Case International IHC	Schlepper / 7110-7488	7120E	Regler AC		0,5	-3,3	1210
750005N	Case International IHC	Schlepper / 7110-7488	7210	Regler AC		0,5	-3,3	1210
750005N	Case International IHC	Schlepper / 7110-7488	7220	Regler AC		0,5	-3,3	1210
750005N	Case International IHC	Schlepper / 7110-7488	7230	Regler AC		0,5	-3,3	1210
750005N	Case International IHC	Schlepper / 7110-7488	7240	Regler AC		0,5	-3,3	1210
750005N	Case International IHC	Schlepper / 7110-7488	7250	Regler AC		0,5	-3,3	1210
750005N	Case International IHC	Schlepper / 7110-7488	7288	Regler AC		0,5	-3,3	1210
750005N	Case International IHC	Schlepper / 7110-7488	7488	Regler AC		0,5	-3,3	1210
750005N	Case International IHC	Schlepper / 8910-8950	8910	Regler AC		0,5	-3,3	1210



Dasis Nr.	Hersteller	Modell	Typ	Spezifikation	Spannung [V]	Einschaltpunkt [°C]	Ausschaltpunkt [°C]	Kapillarrohrlänge [mm]
750005N	Case International IHC	Schlepper / 8910-8950	8920	Regler AC		0,5	-3,3	1210
750005N	Case International IHC	Schlepper / 8910-8950	8930	Regler AC		0,5	-3,3	1210
750005N	Case International IHC	Schlepper / 8910-8950	8940	Regler AC		0,5	-3,3	1210
750005N	Case International IHC	Schlepper / 8910-8950	8950	Regler AC		0,5	-3,3	1210
750005N	Case International IHC	Schlepper / 9110-9390	9210	Regler AC		0,5	-3,3	1210
750005N	Case International IHC	Schlepper / 9110-9390	9230	Regler AC		0,5	-3,3	1210
750005N	Case International IHC	Schlepper / 9110-9390	9240	Regler AC		0,5	-3,3	1210
750005N	Case International IHC	Schlepper / 9110-9390	9250	Regler AC		0,5	-3,3	1210
750005N	Case International IHC	Schlepper / 9110-9390	9260	Regler AC		0,5	-3,3	1210
750005N	Case International IHC	Schlepper / 9110-9390	9270	Regler AC		0,5	-3,3	1210
750005N	Case International IHC	Schlepper / 9110-9390	9280	Regler AC		0,5	-3,3	1210
750005N	Case International IHC	Schlepper / CX	50	Regler AC		0,5	-3,3	1210
750005N	Case International IHC	Schlepper / CX	60	Regler AC		0,5	-3,3	1210
750005N	Case International IHC	Schlepper / CX	70	Regler AC		0,5	-3,3	1210
750005N	Case International IHC	Schlepper / CX	80	Regler AC		0,5	-3,3	1210
750005N	Case International IHC	Schlepper / CX	90	Regler AC		0,5	-3,3	1210
750005N	Case International IHC	Schlepper / CX	100	Regler AC		0,5	-3,3	1210
750005N	Case International IHC	Schlepper / MX	100	Regler AC		0,5	-3,3	1210
750005N	Case International IHC	Schlepper / MX	110	Regler AC		0,5	-3,3	1210
750005N	Case International IHC	Schlepper / MX	120	Regler AC		0,5	-3,3	1210
750005N	Case International IHC	Schlepper / MX	135	Regler AC		0,5	-3,3	1210
750005N	Case International IHC	Schlepper / MX	150	Regler AC		0,5	-3,3	1210
750005N	Case International IHC	Schlepper / MX	170	Regler AC		0,5	-3,3	1210
750005N	Case International IHC	Schlepper / MX	180	Regler AC		0,5	-3,3	1210
750005N	Case International IHC	Schlepper / MX	200	Regler AC		0,5	-3,3	1210
750005N	Case International IHC	Schlepper / MX	210	Regler AC		0,5	-3,3	1210
750005N	Case International IHC	Schlepper / MX	220	Regler AC		0,5	-3,3	1210
750005N	Case International IHC	Schlepper / MX	230	Regler AC		0,5	-3,3	1210
750005N	Case International IHC	Schlepper / MX	240	Regler AC		0,5	-3,3	1210
750005N	Case International IHC	Schlepper / MX	255	Regler AC		0,5	-3,3	1210
750005N	Case International IHC	Schlepper / MX	270	Regler AC		0,5	-3,3	1210
750005N	Case International IHC	Schlepper / MX	285	Regler AC		0,5	-3,3	1210

Dasis Nr.	Hersteller	Modell	Typ	Spezifikation	Spannung [V]	Einschaltpunkt [°C]	Ausschaltpunkt [°C]	Kapillarrohrlänge [mm]
750005N	Case International IHC	Schlepper / MXC	80	Regler AC		0,5	-3,3	1210
750005N	Case International IHC	Schlepper / MXC	90	Regler AC		0,5	-3,3	1210
750005N	Case International IHC	Schlepper / MXC	100	Regler AC		0,5	-3,3	1210
750005N	Case International IHC	Schlepper / PJV Hydro	100	Regler AC		0,5	-3,3	1210
750005N	Case International IHC	Schlepper / PJV Hydro	186	Regler AC		0,5	-3,3	1210
750005N	Case International IHC	Schlepper / Quadtrac	Quadtrac	Regler AC		0,5	-3,3	1210
750005N	Claas	Feldhäcksler / Jaguar	685	Regler AC		0,5	-3,3	1210
750005N	Claas	Feldhäcksler / Jaguar	690	Regler AC		0,5	-3,3	1210
750005N	Claas	Feldhäcksler / Jaguar	695	Regler AC		0,5	-3,3	1210
750005N	Claas	Feldhäcksler / Jaguar	860	Regler AC		0,5	-3,3	1210
750005N	Claas	Feldhäcksler / Jaguar	880	Regler AC		0,5	-3,3	1210
750005N	Claas	Mähdrescher / Dominator 8	98	Regler AC		0,5	-3,3	1210
750005N	Claas	Mähdrescher / Mega	202	Regler AC		0,5	-3,3	1210
750005N	Claas	Mähdrescher / Mega	203	Regler AC		0,5	-3,3	1210
750005N	Claas	Mähdrescher / Mega	204	Regler AC		0,5	-3,3	1210
750005N	Claas	Mähdrescher / Mega	208	Regler AC		0,5	-3,3	1210
750005N	Claas	Mähdrescher / Mega	218	Regler AC		0,5	-3,3	1210
901811N	Claas	Teleskoplader	Maxi Swather					
901825N	Fendt	Schlepper / Farmer 300	304	Regler AC	12	3,8	-0,5	609
901825N	Fendt	Schlepper / Farmer 300	305	Regler AC	12	3,8	-0,5	609
901825N	Fendt	Schlepper / Farmer 300	306	Regler AC	12	3,8	-0,5	609
901825N	Fendt	Schlepper / Farmer 300	307	Regler AC	12	3,8	-0,5	609
901825N	Fendt	Schlepper / Farmer 300	308	Regler AC	12	3,8	-0,5	609
901825N	Fendt	Schlepper / Farmer 300	309	Regler AC	12	3,8	-0,5	609
901825N	Fendt	Schlepper / Farmer 300	310	Regler AC	12	3,8	-0,5	609
901825N	Fendt	Schlepper / Farmer 300	311	Regler AC	12	3,8	-0,5	609
901825N	Fendt	Schlepper / Farmer 300	312	Regler AC	12	3,8	-0,5	609
901825N	Fendt	Schlepper / Favorit 500	509	Regler AC	12	3,8	-0,5	609
901825N	Fendt	Schlepper / Favorit 500	510	Regler AC	12	3,8	-0,5	609
901825N	Fendt	Schlepper / Favorit 500	512	Regler AC	12	3,8	-0,5	609
901825N	Fendt	Schlepper / Favorit 500	514	Regler AC	12	3,8	-0,5	609

Dasis Nr.	Hersteller	Modell	Typ	Spezifikation	Spannung [V]	Einschaltpunkt [°C]	Ausschaltpunkt [°C]	Kapillarrohrlänge [mm]
901825N	Fendt	Schlepper / Favorit 500	515	Regler AC	12	3,8	-0,5	609
901825N	Fendt	Schlepper / Favorit 600	611	Regler AC	12	3,8	-0,5	609
901825N	Fendt	Schlepper / Favorit 600	612	Regler AC	12	3,8	-0,5	609
901825N	Fendt	Schlepper / Favorit 600	614	Regler AC	12	3,8	-0,5	609
901825N	Fendt	Schlepper / Favorit 600	615	Regler AC	12	3,8	-0,5	609
901825N	Fendt	Schlepper / Favorit 800	816	Regler AC	12	3,8	-0,5	609
901825N	Fendt	Schlepper / Favorit 800	818	Regler AC	12	3,8	-0,5	609
901825N	Fendt	Schlepper / Favorit 800	822	Regler AC	12	3,8	-0,5	609
901825N	Fendt	Schlepper / Favorit 800	824	Regler AC	12	3,8	-0,5	609
901825N	Fendt	Schlepper / Favorit 900	916	Regler AC	12	3,8	-0,5	609
901825N	Fendt	Schlepper / Favorit 900	920	Regler AC	12	3,8	-0,5	609
901825N	Fendt	Schlepper / Favorit 900	924	Regler AC	12	3,8	-0,5	609
901825N	Fendt	Schlepper / Favorit 900	926	Regler AC	12	3,8	-0,5	609
901825N	Fendt	Schlepper / Xylon	520	Regler AC	12	3,8	-0,5	609
901825N	Fendt	Schlepper / Xylon	522	Regler AC	12	3,8	-0,5	609
901825N	Fendt	Schlepper / Xylon	524	Regler AC	12	3,8	-0,5	609
750005N	Fiat / Hitachi	Schlepper	580	Regler AC		0,5	-3,3	1210
750005N	Fiat / Hitachi	Schlepper	680	Regler AC		0,5	-3,3	1210
750005N	Fiat / Hitachi	Schlepper	780	Regler AC		0,5	-3,3	1210
750005N	Fiat / Hitachi	Schlepper	880	Regler AC		0,5	-3,3	1210
750005N	Fiat / Hitachi	Schlepper	980	Regler AC		0,5	-3,3	1210
750005N	Fiat / Hitachi	Schlepper ....-80	580	Regler AC		0,5	-3,3	1210
750005N	Fiat / Hitachi	Schlepper ....-80	580DT	Regler AC		0,5	-3,3	1210
750005N	Fiat / Hitachi	Schlepper ....-80	680	Regler AC		0,5	-3,3	1210
750005N	Fiat / Hitachi	Schlepper ....-80	680DT	Regler AC		0,5	-3,3	1210
750005N	Fiat / Hitachi	Schlepper ....-80	780	Regler AC		0,5	-3,3	1210
750005N	Fiat / Hitachi	Schlepper ....-80	780DT	Regler AC		0,5	-3,3	1210
750005N	Fiat / Hitachi	Schlepper ....-80	880	Regler AC		0,5	-3,3	1210
750005N	Fiat / Hitachi	Schlepper ....-80	880DT	Regler AC		0,5	-3,3	1210
750005N	Fiat / Hitachi	Schlepper ....-80	980	Regler AC		0,5	-3,3	1210
750005N	Fiat / Hitachi	Schlepper ....-80	980DT	Regler AC		0,5	-3,3	1210
750005N	Fiat / Hitachi	Schlepper ....-80	1180	Regler AC		0,5	-3,3	1210

Dasis Nr.	Hersteller	Modell	Typ	Spezifikation	Spannung [V]	Einschaltpunkt [°C]	Ausschaltpunkt [°C]	Kapillarrohrlänge [mm]
750005N	Fiat / Hitachi	Schlepper .....80	1180DT	Regler AC		0,5	-3,3	1210
750005N	Fiat / Hitachi	Schlepper .....80	1180T	Regler AC		0,5	-3,3	1210
750005N	Fiat / Hitachi	Schlepper .....80	1280	Regler AC		0,5	-3,3	1210
750005N	Fiat / Hitachi	Schlepper .....80	1280DT	Regler AC		0,5	-3,3	1210
750005N	Fiat / Hitachi	Schlepper .....80	1280T	Regler AC		0,5	-3,3	1210
750005N	Fiat / Hitachi	Schlepper .....80	1380	Regler AC		0,5	-3,3	1210
750005N	Fiat / Hitachi	Schlepper .....80	1380DT	Regler AC		0,5	-3,3	1210
750005N	Fiat / Hitachi	Schlepper .....80	1580	Regler AC		0,5	-3,3	1210
750005N	Fiat / Hitachi	Schlepper .....80	1580DT	Regler AC		0,5	-3,3	1210
750005N	Fiat / Hitachi	Schlepper .....80	1580DTTurbo	Regler AC		0,5	-3,3	1210
750005N	Fiat / Hitachi	Schlepper .....80	1580T	Regler AC		0,5	-3,3	1210
750005N	Fiat / Hitachi	Schlepper .....80	1580Turbo	Regler AC		0,5	-3,3	1210
750005N	Fiat / Hitachi	Schlepper .....80	1880	Regler AC		0,5	-3,3	1210
750005N	Fiat / Hitachi	Schlepper .....80	1880DT	Regler AC		0,5	-3,3	1210
750005N	Fiat / Hitachi	Schlepper .....90	55-90	Regler AC		0,5	-3,3	1210
750005N	Fiat / Hitachi	Schlepper .....90	55-90DT	Regler AC		0,5	-3,3	1210
750005N	Fiat / Hitachi	Schlepper .....90	60-90DT	Regler AC		0,5	-3,3	1210
750005N	Fiat / Hitachi	Schlepper .....90	65-90	Regler AC		0,5	-3,3	1210
750005N	Fiat / Hitachi	Schlepper .....90	65-90DT	Regler AC		0,5	-3,3	1210
750005N	Fiat / Hitachi	Schlepper .....90	70-90DT	Regler AC		0,5	-3,3	1210
750005N	Fiat / Hitachi	Schlepper .....90	80-90	Regler AC		0,5	-3,3	1210
750005N	Fiat / Hitachi	Schlepper .....90	80-90DT	Regler AC		0,5	-3,3	1210
750005N	Fiat / Hitachi	Schlepper .....90	85-90DT	Regler AC		0,5	-3,3	1210
750005N	Fiat / Hitachi	Schlepper .....90	95-90DT	Regler AC		0,5	-3,3	1210
750005N	Fiat / Hitachi	Schlepper .....90	100-90DT	Regler AC		0,5	-3,3	1210
750005N	Fiat / Hitachi	Schlepper .....90	110-90DT	Regler AC		0,5	-3,3	1210
750005N	Fiat / Hitachi	Schlepper .....90	115-90DT	Regler AC		0,5	-3,3	1210
750005N	Fiat / Hitachi	Schlepper .....90	130-90DT	Regler AC		0,5	-3,3	1210
750005N	Fiat / Hitachi	Schlepper .....90	140-90DT	Regler AC		0,5	-3,3	1210
750005N	Fiat / Hitachi	Schlepper .....90	160-90DT	Regler AC		0,5	-3,3	1210
750005N	Fiat / Hitachi	Schlepper .....90	180-90DT	Regler AC		0,5	-3,3	1210
750005N	Fiat / Hitachi	Schlepper / F	100	Regler AC		0,5	-3,3	1210

Dasis Nr.	Hersteller	Modell	Typ	Spezifikation	Spannung [V]	Einschaltpunkt [°C]	Ausschaltpunkt [°C]	Kapillarrohrlänge [mm]
750005N	Fiat / Hitachi	Schlepper / F	110	Regler AC		0,5	-3,3	1210
750005N	Fiat / Hitachi	Schlepper / F	112	Regler AC		0,5	-3,3	1210
750005N	Fiat / Hitachi	Schlepper / F	115	Regler AC		0,5	-3,3	1210
750005N	Fiat / Hitachi	Schlepper / F	120	Regler AC		0,5	-3,3	1210
750005N	Fiat / Hitachi	Schlepper / F	130	Regler AC		0,5	-3,3	1210
750005N	Fiat / Hitachi	Schlepper / F	140	Regler AC		0,5	-3,3	1210
750005N	Fiat / Hitachi	Schlepper / F	140DT	Regler AC		0,5	-3,3	1210
901812N	Fiat / Hitachi	Schlepper / G	170	Regler AC				609
901812N	Fiat / Hitachi	Schlepper / G	190	Regler AC				609
901812N	Fiat / Hitachi	Schlepper / G	210	Regler AC				609
901812N	Fiat / Hitachi	Schlepper / G	240	Regler AC				609
901813N	John Deere	Baggerlader / 110-726B	300	Regler AC		2,2	-4	457
750013N	John Deere	Baggerlader / 110-726B	310	Regler AC		1	-2	1828
901813N	John Deere	Baggerlader / 110-726B	310	Regler AC		2,2	-4	457
750013N	John Deere	Baggerlader / 110-726B	310E	Regler AC		1	-2	1828
901813N	John Deere	Baggerlader / 110-726B	310E	Regler AC		2,2	-4	457
901812N	John Deere	Baggerlader / 110-726B	310G	Regler AC				609
750013N	John Deere	Baggerlader / 110-726B	310G	Regler AC		1	-2	1828
750013N	John Deere	Baggerlader / 110-726B	310SE	Regler AC		1	-2	1828
901813N	John Deere	Baggerlader / 110-726B	310SE	Regler AC		2,2	-4	457
750013N	John Deere	Baggerlader / 110-726B	310SG	Regler AC		1	-2	1828
901813N	John Deere	Baggerlader / 110-726B	310SG	Regler AC		2,2	-4	457
750013N	John Deere	Baggerlader / 110-726B	315	Regler AC		1	-2	1828
901813N	John Deere	Baggerlader / 110-726B	315	Regler AC		2,2	-4	457
901812N	John Deere	Baggerlader / 110-726B	315SG	Regler AC				609
750013N	John Deere	Baggerlader / 110-726B	315SG	Regler AC		1	-2	1828
750013N	John Deere	Baggerlader / 110-726B	410	Regler AC		1	-2	1828
901813N	John Deere	Baggerlader / 110-726B	410	Regler AC		2,2	-4	457
750013N	John Deere	Baggerlader / 110-726B	410B	Regler AC		1	-2	1828
750013N	John Deere	Baggerlader / 110-726B	410E	Regler AC		1	-2	1828
901813N	John Deere	Baggerlader / 110-726B	410E	Regler AC		2,2	-4	457
901812N	John Deere	Baggerlader / 110-726B	410G	Regler AC				609

Dasis Nr.	Hersteller	Modell	Typ	Spezifikation	Spannung [V]	Einschaltpunkt [°C]	Ausschaltpunkt [°C]	Kapillarrohrlänge [mm]
750013N	John Deere	Baggerlader / 110-726B	410G	Regler AC		1	-2	1828
750013N	John Deere	Baggerlader / 110-726B	510	Regler AC		1	-2	1828
901813N	John Deere	Baggerlader / 110-726B	510	Regler AC		2,2	-4	457
750013N	John Deere	Baggerlader / 110-726B	510B	Regler AC		1	-2	1828
901812N	John Deere	Baggerlader / 110-726B	544J	Regler AC				609
750013N	John Deere	Baggerlader / 110-726B	544J	Regler AC		1	-2	1828
750013N	John Deere	Baggerlader / 110-726B	624G	Regler AC		1	-2	1828
901813N	John Deere	Baggerlader / 110-726B	624G	Regler AC		2,2	-4	457
901813N	John Deere	Baggerlader / 110-726B	710	Regler AC		2,2	-4	457
750013N	John Deere	Baggerlader / 110-726B	726B	Regler AC		1	-2	1828
750013N	John Deere	Mähdrescher / 900-1188	1052	Regler AC		1	-2	1828
750013N	John Deere	Mähdrescher / 900-1188	1055	Regler AC		1	-2	1828
750013N	John Deere	Mähdrescher / 900-1188	1065	Regler AC		1	-2	1828
750013N	John Deere	Mähdrescher / 900-1188	1068H	Regler AC		1	-2	1828
750013N	John Deere	Mähdrescher / 900-1188	1072	Regler AC		1	-2	1828
750013N	John Deere	Mähdrescher / 900-1188	1075	Regler AC		1	-2	1828
750013N	John Deere	Mähdrescher / 900-1188	1075H4	Regler AC		1	-2	1828
750013N	John Deere	Mähdrescher / 900-1188	1085	Regler AC		1	-2	1828
750013N	John Deere	Mähdrescher / 900-1188	1085H4	Regler AC		1	-2	1828
750013N	John Deere	Mähdrescher / 900-1188	1155	Regler AC		1	-2	1828
750013N	John Deere	Mähdrescher / 900-1188	1157	Regler AC		1	-2	1828
750013N	John Deere	Mähdrescher / 900-1188	1158	Regler AC		1	-2	1828
750013N	John Deere	Mähdrescher / 900-1188	1166	Regler AC		1	-2	1828
750013N	John Deere	Mähdrescher / 900-1188	1169	Regler AC		1	-2	1828
750013N	John Deere	Mähdrescher / 900-1188	1169H	Regler AC		1	-2	1828
750013N	John Deere	Mähdrescher / 900-1188	1169H4	Regler AC		1	-2	1828
750013N	John Deere	Mähdrescher / 900-1188	1170	Regler AC		1	-2	1828
750013N	John Deere	Mähdrescher / 900-1188	1174	Regler AC		1	-2	1828
750013N	John Deere	Mähdrescher / 900-1188	1175	Regler AC		1	-2	1828
750013N	John Deere	Mähdrescher / 900-1188	1177	Regler AC		1	-2	1828
750013N	John Deere	Mähdrescher / 900-1188	1177H4	Regler AC		1	-2	1828
750013N	John Deere	Mähdrescher / 900-1188	1188	Regler AC		1	-2	1828

Dasis Nr.	Hersteller	Modell	Typ	Spezifikation	Spannung [V]	Einschaltpunkt [°C]	Ausschaltpunkt [°C]	Kapillarrohrlänge [mm]
750013N	John Deere	Mähdrescher / 900-1188	1188H4	Regler AC		1	-2	1828
901812N	John Deere	Minibagger / 200-800	360	Regler AC				609
901812N	John Deere	Minibagger / 200-800	460	Regler AC				609
901813N	John Deere	Minibagger / 200-800	531S	Regler AC		2,2	-4	457
901813N	John Deere	Minibagger / 200-800	540E	Regler AC		2,2	-4	457
901813N	John Deere	Minibagger / 200-800	540G	Regler AC		2,2	-4	457
901813N	John Deere	Minibagger / 200-800	548E	Regler AC		2,2	-4	457
901813N	John Deere	Minibagger / 200-800	640E	Regler AC		2,2	-4	457
901813N	John Deere	Minibagger / 200-800	640G	Regler AC		2,2	-4	457
901813N	John Deere	Minibagger / 200-800	648E	Regler AC		2,2	-4	457
901813N	John Deere	Minibagger / 200-800	740E	Regler AC		2,2	-4	457
901813N	John Deere	Minibagger / 200-800	740G	Regler AC		2,2	-4	457
750013N	John Deere	Minibagger / 200-800	855	Regler AC		1	-2	1828
901812N	John Deere	Motorgrader / 400-800	670	Regler AC				609
901812N	John Deere	Motorgrader / 400-800	670B	Regler AC				609
901812N	John Deere	Motorgrader / 400-800	670H	Regler AC				609
901812N	John Deere	Motorgrader / 400-800	672	Regler AC				609
901812N	John Deere	Motorgrader / 400-800	672B	Regler AC				609
901812N	John Deere	Motorgrader / 400-800	672H	Regler AC				609
901812N	John Deere	Motorgrader / 400-800	770	Regler AC				609
901812N	John Deere	Motorgrader / 400-800	770B	Regler AC				609
901812N	John Deere	Motorgrader / 400-800	770BH	Regler AC				609
901812N	John Deere	Motorgrader / 400-800	772	Regler AC				609
901812N	John Deere	Motorgrader / 400-800	772B	Regler AC				609
901812N	John Deere	Motorgrader / 400-800	772BH	Regler AC				609
901812N	John Deere	Motorgrader / 400-800	870	Regler AC				609
901813N	John Deere	Muldenkipper / 200-700	748E	Regler AC		2,2	-4	457
901813N	John Deere	Raupen Dozer / 400-850	450H	Regler AC		2,2	-4	457
901813N	John Deere	Raupen Dozer / 400-850	550H	Regler AC		2,2	-4	457
901813N	John Deere	Raupen Dozer / 400-850	650H	Regler AC		2,2	-4	457
750013N	John Deere	Raupen Dozer / 400-850	655	Regler AC		1	-2	1828
901812N	John Deere	Raupen Dozer / 400-850	700H	Regler AC				609

Dasis Nr.	Hersteller	Modell	Typ	Spezifikation	Spannung [V]	Einschaltpunkt [°C]	Ausschaltpunkt [°C]	Kapillarrohrlänge [mm]
901813N	John Deere	Raupen Dozer / 400-850	710	Regler AC		2,2	-4	457
901812N	John Deere	Raupen Dozer / 400-850	750	Regler AC				609
901812N	John Deere	Raupen Dozer / 400-850	750J	Regler AC				609
901812N	John Deere	Raupen Dozer / 400-850	850	Regler AC				609
750013N	John Deere	Raupen Dozer / 400-850	850	Regler AC		1	-2	1828
901812N	John Deere	Raupen Dozer / 400-850	850J	Regler AC				609
901812N	John Deere	Schaufellader / 400-800 Serie	444J	Regler AC				609
901813N	John Deere	Schaufellader / 400-800 Serie	544G	Regler AC		2,2	-4	457
901813N	John Deere	Schaufellader / 400-800 Serie	4890	Regler AC		2,2	-4	457
901813N	John Deere	Schaufellader / 400-800 Serie	4895	Regler AC		2,2	-4	457
901813N	John Deere	Schaufellader / 400-800 Serie	4990	Regler AC		2,2	-4	457
901813N	John Deere	Schaufellader / 400-800 Serie	4995	Regler AC		2,2	-4	457
901812N	John Deere	Schaufellader / 400-800 Serie	T44H	Regler AC				609
901812N	John Deere	Schaufellader / 400-800 Serie	T54H	Regler AC				609
750013N	John Deere	Schlepper / 300-955	830	Regler AC		1	-2	1828
750013N	John Deere	Schlepper / 300-955	840	Regler AC		1	-2	1828
750013N	John Deere	Schlepper / 300-955	930	Regler AC		1	-2	1828
750013N	John Deere	Schlepper / 300-955	940	Regler AC		1	-2	1828
750013N	John Deere	Schlepper / 300-955	940V	Regler AC		1	-2	1828
750013N	John Deere	Schlepper / 1000-1950	1030	Regler AC		1	-2	1828
750013N	John Deere	Schlepper / 1000-1950	1030OU	Regler AC		1	-2	1828
750013N	John Deere	Schlepper / 1000-1950	1030V	Regler AC		1	-2	1828
750013N	John Deere	Schlepper / 1000-1950	1040	Regler AC		1	-2	1828
750013N	John Deere	Schlepper / 1000-1950	1040V	Regler AC		1	-2	1828
750013N	John Deere	Schlepper / 1000-1950	1130	Regler AC		1	-2	1828
750013N	John Deere	Schlepper / 1000-1950	1140	Regler AC		1	-2	1828
750013N	John Deere	Schlepper / 1000-1950	1140F	Regler AC		1	-2	1828
750013N	John Deere	Schlepper / 1000-1950	1140V	Regler AC		1	-2	1828



Dasis Nr.	Hersteller	Modell	Typ	Spezifikation	Spannung [V]	Einschaltpunkt [°C]	Ausschaltpunkt [°C]	Kapillarrohrlänge [mm]
750013N	John Deere	Schlepper / 1000-1950	1350	Regler AC		1	-2	1828
750013N	John Deere	Schlepper / 1000-1950	1530	Regler AC		1	-2	1828
750013N	John Deere	Schlepper / 1000-1950	1550	Regler AC		1	-2	1828
750013N	John Deere	Schlepper / 1000-1950	1630	Regler AC		1	-2	1828
750013N	John Deere	Schlepper / 1000-1950	1630OU	Regler AC		1	-2	1828
750013N	John Deere	Schlepper / 1000-1950	1630V	Regler AC		1	-2	1828
750013N	John Deere	Schlepper / 1000-1950	1640	Regler AC		1	-2	1828
750013N	John Deere	Schlepper / 1000-1950	1640F	Regler AC		1	-2	1828
750013N	John Deere	Schlepper / 1000-1950	1750	Regler AC		1	-2	1828
750013N	John Deere	Schlepper / 1000-1950	1830	Regler AC		1	-2	1828
750013N	John Deere	Schlepper / 1000-1950	1840	Regler AC		1	-2	1828
750013N	John Deere	Schlepper / 1000-1950	1840F	Regler AC		1	-2	1828
750013N	John Deere	Schlepper / 1000-1950	1850	Regler AC		1	-2	1828
750013N	John Deere	Schlepper / 1000-1950	1850F	Regler AC		1	-2	1828
750013N	John Deere	Schlepper / 1000-1950	1850V	Regler AC		1	-2	1828
750013N	John Deere	Schlepper / 1000-1950	1950	Regler AC		1	-2	1828
750013N	John Deere	Schlepper / 1000-1950	1950F	Regler AC		1	-2	1828
750013N	John Deere	Schlepper / 2000-2955	2030	Regler AC		1	-2	1828
750013N	John Deere	Schlepper / 2000-2955	2040	Regler AC		1	-2	1828
750013N	John Deere	Schlepper / 2000-2955	2040F	Regler AC		1	-2	1828
750013N	John Deere	Schlepper / 2000-2955	2040S	Regler AC		1	-2	1828
750013N	John Deere	Schlepper / 2000-2955	2130	Regler AC		1	-2	1828
750013N	John Deere	Schlepper / 2000-2955	2140	Regler AC		1	-2	1828
750013N	John Deere	Schlepper / 2000-2955	2240	Regler AC		1	-2	1828
750013N	John Deere	Schlepper / 2000-2955	2250	Regler AC		1	-2	1828
750013N	John Deere	Schlepper / 2000-2955	2450	Regler AC		1	-2	1828
750013N	John Deere	Schlepper / 2000-2955	2550	Regler AC		1	-2	1828
750013N	John Deere	Schlepper / 2000-2955	2650	Regler AC		1	-2	1828
750013N	John Deere	Schlepper / 2000-2955	2650F	Regler AC		1	-2	1828
750013N	John Deere	Schlepper / 2000-2955	2850	Regler AC		1	-2	1828
750013N	John Deere	Schlepper / 3000-3650	3030	Regler AC		1	-2	1828
750013N	John Deere	Schlepper / 3000-3650	3040	Regler AC		1	-2	1828

Dasis Nr.	Hersteller	Modell	Typ	Spezifikation	Spannung [V]	Einschaltpunkt [°C]	Ausschaltpunkt [°C]	Kapillarrohrlänge [mm]
750013N	John Deere	Schlepper / 3000-3650	3050	Regler AC		1	-2	1828
750013N	John Deere	Schlepper / 3000-3650	3130	Regler AC		1	-2	1828
750013N	John Deere	Schlepper / 3000-3650	3140	Regler AC		1	-2	1828
750013N	John Deere	Schlepper / 3000-3650	3150	Regler AC		1	-2	1828
750013N	John Deere	Schlepper / 3000-3650	3340	Regler AC		1	-2	1828
750013N	John Deere	Schlepper / 3000-3650	3350	Regler AC		1	-2	1828
750013N	John Deere	Schlepper / 3000-3650	3640	Regler AC		1	-2	1828
750013N	John Deere	Schlepper / 3000-3650	3650	Regler AC		1	-2	1828
750013N	John Deere	Schlepper / 4000-4955	4040	Regler AC		1	-2	1828
750013N	John Deere	Schlepper / 4000-4955	4040S	Regler AC		1	-2	1828
750013N	John Deere	Schlepper / 4000-4955	4050	Regler AC		1	-2	1828
750013N	John Deere	Schlepper / 4000-4955	4230	Regler AC		1	-2	1828
750013N	John Deere	Schlepper / 4000-4955	4240	Regler AC		1	-2	1828
750013N	John Deere	Schlepper / 4000-4955	4240S	Regler AC		1	-2	1828
750013N	John Deere	Schlepper / 4000-4955	4250	Regler AC		1	-2	1828
750013N	John Deere	Schlepper / 4000-4955	4350	Regler AC		1	-2	1828
750013N	John Deere	Schlepper / 4000-4955	4430	Regler AC		1	-2	1828
750013N	John Deere	Schlepper / 4000-4955	4440	Regler AC		1	-2	1828
750013N	John Deere	Schlepper / 4000-4955	4450	Regler AC		1	-2	1828
750013N	John Deere	Schlepper / 4000-4955	4630	Regler AC		1	-2	1828
750013N	John Deere	Schlepper / 4000-4955	4640	Regler AC		1	-2	1828
750013N	John Deere	Schlepper / 4000-4955	4650	Regler AC		1	-2	1828
750013N	John Deere	Schlepper / 4000-4955	4840	Regler AC		1	-2	1828
750013N	John Deere	Schlepper / 4000-4955	4850	Regler AC		1	-2	1828
750013N	John Deere	Schlepper / 5000-5820	5220	Regler AC		1	-2	1828
750013N	John Deere	Schlepper / 5000-5820	5300	Regler AC		1	-2	1828
750013N	John Deere	Schlepper / 5000-5820	5310	Regler AC		1	-2	1828
750013N	John Deere	Schlepper / 5000-5820	5320	Regler AC		1	-2	1828
750013N	John Deere	Schlepper / 5000-5820	5400	Regler AC		1	-2	1828
750013N	John Deere	Schlepper / 5000-5820	5410	Regler AC		1	-2	1828
750013N	John Deere	Schlepper / 5000-5820	5420	Regler AC		1	-2	1828
750013N	John Deere	Schlepper / 5000-5820	5500	Regler AC		1	-2	1828

Dasis Nr.	Hersteller	Modell	Typ	Spezifikation	Spannung [V]	Einschaltpunkt [°C]	Ausschaltpunkt [°C]	Kapillarrohrlänge [mm]
750013N	John Deere	Schlepper / 5000-5820	5520	Regler AC		1	-2	1828
750013N	John Deere	Schlepper / 6000-6930	6010	Regler AC		1	-2	1828
750013N	John Deere	Schlepper / 6000-6930	6010SE	Regler AC		1	-2	1828
750013N	John Deere	Schlepper / 6000-6930	6020SE	Regler AC		1	-2	1828
750013N	John Deere	Schlepper / 6000-6930	6100	Regler AC		1	-2	1828
750013N	John Deere	Schlepper / 6000-6930	6110	Regler AC		1	-2	1828
750013N	John Deere	Schlepper / 6000-6930	6110SE	Regler AC		1	-2	1828
750013N	John Deere	Schlepper / 6000-6930	6120	Regler AC		1	-2	1828
750013N	John Deere	Schlepper / 6000-6930	6120SE	Regler AC		1	-2	1828
750013N	John Deere	Schlepper / 6000-6930	6200	Regler AC		1	-2	1828
750013N	John Deere	Schlepper / 6000-6930	6210	Regler AC		1	-2	1828
750013N	John Deere	Schlepper / 6000-6930	6210SE	Regler AC		1	-2	1828
750013N	John Deere	Schlepper / 6000-6930	6220	Regler AC		1	-2	1828
750013N	John Deere	Schlepper / 6000-6930	6220SE	Regler AC		1	-2	1828
750013N	John Deere	Schlepper / 6000-6930	6300	Regler AC		1	-2	1828
750013N	John Deere	Schlepper / 6000-6930	6310	Regler AC		1	-2	1828
750013N	John Deere	Schlepper / 6000-6930	6310SE	Regler AC		1	-2	1828
750013N	John Deere	Schlepper / 6000-6930	6320	Regler AC		1	-2	1828
750013N	John Deere	Schlepper / 6000-6930	6320SE	Regler AC		1	-2	1828
750013N	John Deere	Schlepper / 6000-6930	6400	Regler AC		1	-2	1828
750013N	John Deere	Schlepper / 6000-6930	6410	Regler AC		1	-2	1828
750013N	John Deere	Schlepper / 6000-6930	6410SE	Regler AC		1	-2	1828
750013N	John Deere	Schlepper / 6000-6930	6420	Regler AC		1	-2	1828
750013N	John Deere	Schlepper / 6000-6930	6420S	Regler AC		1	-2	1828
750013N	John Deere	Schlepper / 6000-6930	6420SE	Regler AC		1	-2	1828
750013N	John Deere	Schlepper / 6000-6930	6510	Regler AC		1	-2	1828
750013N	John Deere	Schlepper / 6000-6930	6510SE	Regler AC		1	-2	1828
750013N	John Deere	Schlepper / 6000-6930	6520SE	Regler AC		1	-2	1828
750013N	John Deere	Schlepper / 6000-6930	6610	Regler AC		1	-2	1828
750013N	John Deere	Schlepper / 6000-6930	6610SE	Regler AC		1	-2	1828
750013N	John Deere	Schlepper / 6000-6930	6810	Regler AC		1	-2	1828
750013N	John Deere	Schlepper / 6000-6930	6910	Regler AC		1	-2	1828

Dasis Nr.	Hersteller	Modell	Typ	Spezifikation	Spannung [V]	Einschaltpunkt [°C]	Ausschaltpunkt [°C]	Kapillarrohrlänge [mm]
750013N	John Deere	Schlepper / 6000-6930	6910S	Regler AC		1	-2	1828
750013N	John Deere	Schlepper / 8000-8640	8430	Regler AC		1	-2	1828
750013N	John Deere	Schlepper / 8000-8640	8440	Regler AC		1	-2	1828
750013N	John Deere	Schlepper / 8000-8640	8640	Regler AC		1	-2	1828
750013N	John Deere	Schlepper Wein Obst / 5000N-9620	5215F	Regler AC		1	-2	1828
750013N	John Deere	Schlepper Wein Obst / 5000N-9620	5215V	Regler AC		1	-2	1828
750013N	John Deere	Schlepper Wein Obst / 5000N-9620	5300	Regler AC		1	-2	1828
750013N	John Deere	Schlepper Wein Obst / 5000N-9620	5310	Regler AC		1	-2	1828
750013N	John Deere	Schlepper Wein Obst / 5000N-9620	5315F	Regler AC		1	-2	1828
750013N	John Deere	Schlepper Wein Obst / 5000N-9620	5315V	Regler AC		1	-2	1828
750013N	John Deere	Schlepper Wein Obst / 5000N-9620	5400	Regler AC		1	-2	1828
750013N	John Deere	Schlepper Wein Obst / 5000N-9620	5410	Regler AC		1	-2	1828
750013N	John Deere	Schlepper Wein Obst / 5000N-9620	5500	Regler AC		1	-2	1828
901812N	John Deere	Schürfzüge / 800	872	Regler AC				609
901812N	John Deere	Selbstfahrende Feldspritze	4700	Regler AC				609
901812N	John Deere	Selbstfahrende Feldspritze	4710	Regler AC				609
750013N	John Deere	Selbstfahrende Feldspritze	6000	Regler AC		1	-2	1828
750013N	John Deere	Selbstfahrende Feldspritze	6500	Regler AC		1	-2	1828
750013N	John Deere	Selbstfahrende Schwadmäher / 2200-6670	2320	Regler AC		1	-2	1828
750013N	John Deere	Selbstfahrende Schwadmäher / 2200-6670	2420	Regler AC		1	-2	1828
750013N	John Deere	Selbstfahrende Schwadmäher / 2200-6670	3430	Regler AC		1	-2	1828

Dasis Nr.	Hersteller	Modell	Typ	Spezifikation	Spannung [V]	Einschaltpunkt [°C]	Ausschaltpunkt [°C]	Kapillarrohrlänge [mm]
750013N	John Deere	Selbstfahrende Schwadmäher / 2200-6670	3830	Regler AC		1	-2	1828
750005N	Massey Ferguson	Mähdrescher / 3400-9790	7250	Regler AC		0,5	-3,3	1210
750005N	Massey Ferguson	Mähdrescher / 3400-9790	7252	Regler AC		0,5	-3,3	1210
750005N	Massey Ferguson	Mähdrescher / 3400-9790	7254	Regler AC		0,5	-3,3	1210
750005N	Massey Ferguson	Mähdrescher / 3400-9790	7256	Regler AC		0,5	-3,3	1210
750005N	Massey Ferguson	Mähdrescher / 3400-9790	7272	Regler AC		0,5	-3,3	1210
750005N	Massey Ferguson	Mähdrescher / 3400-9790	7274	Regler AC		0,5	-3,3	1210
750005N	Massey Ferguson	Mähdrescher / 3400-9790	7276	Regler AC		0,5	-3,3	1210
750005N	Massey Ferguson	Mähdrescher / 3400-9790	7278	Regler AC		0,5	-3,3	1210
750005N	Massey Ferguson	Mähdrescher / MF 24-40	24	Regler AC		0,5	-3,3	1210
750005N	Massey Ferguson	Mähdrescher / MF 24-40	27	Regler AC		0,5	-3,3	1210
750005N	Massey Ferguson	Mähdrescher / MF 24-40	29	Regler AC		0,5	-3,3	1210
750005N	Massey Ferguson	Mähdrescher / MF 24-40	29XP	Regler AC		0,5	-3,3	1210
750005N	Massey Ferguson	Mähdrescher / MF 24-40	30	Regler AC		0,5	-3,3	1210
750005N	Massey Ferguson	Mähdrescher / MF 24-40	31	Regler AC		0,5	-3,3	1210
750005N	Massey Ferguson	Mähdrescher / MF 24-40	31XP	Regler AC		0,5	-3,3	1210
750005N	Massey Ferguson	Mähdrescher / MF 24-40	32	Regler AC		0,5	-3,3	1210
750005N	Massey Ferguson	Mähdrescher / MF 24-40	34	Regler AC		0,5	-3,3	1210
750005N	Massey Ferguson	Mähdrescher / MF 24-40	36	Regler AC		0,5	-3,3	1210
750005N	Massey Ferguson	Mähdrescher / MF 24-40	38	Regler AC		0,5	-3,3	1210
750005N	Massey Ferguson	Mähdrescher / MF 24-40	40	Regler AC		0,5	-3,3	1210
750004N	Massey Ferguson	Schlepper / 4000	4215	Regler AC	12	0,5	-3,3	914
750004N	Massey Ferguson	Schlepper / 4000	4220	Regler AC	12	0,5	-3,3	914
750004N	Massey Ferguson	Schlepper / 4000	4225	Regler AC	12	0,5	-3,3	914
750004N	Massey Ferguson	Schlepper / 4000	4235	Regler AC	12	0,5	-3,3	914
750004N	Massey Ferguson	Schlepper / 4000	4240	Regler AC	12	0,5	-3,3	914
750004N	Massey Ferguson	Schlepper / 4000	4243	Regler AC	12	0,5	-3,3	914
750004N	Massey Ferguson	Schlepper / 4000	4245	Regler AC	12	0,5	-3,3	914
750004N	Massey Ferguson	Schlepper / 4000	4253	Regler AC	12	0,5	-3,3	914
750004N	Massey Ferguson	Schlepper / 4000	4255	Regler AC	12	0,5	-3,3	914
750004N	Massey Ferguson	Schlepper / 4000	4260	Regler AC	12	0,5	-3,3	914

Dasis Nr.	Hersteller	Modell	Typ	Spezifikation	Spannung [V]	Einschaltpunkt [°C]	Ausschaltpunkt [°C]	Kapillarrohrlänge [mm]
750004N	Massey Ferguson	Schlepper / 4000	4263	Regler AC	12	0,5	-3,3	914
750004N	Massey Ferguson	Schlepper / 4000	4265	Regler AC	12	0,5	-3,3	914
750004N	Massey Ferguson	Schlepper / 4000	4270	Regler AC	12	0,5	-3,3	914
750005N	Massey Ferguson	Schlepper / Dronningborg	24	Regler AC		0,5	-3,3	1210
750005N	Massey Ferguson	Schlepper / Dronningborg	29P	Regler AC		0,5	-3,3	1210
750005N	Massey Ferguson	Schlepper / Dronningborg	30	Regler AC		0,5	-3,3	1210
750005N	Massey Ferguson	Schlepper / Dronningborg	31P	Regler AC		0,5	-3,3	1210
750005N	Massey Ferguson	Schlepper / Dronningborg	32	Regler AC		0,5	-3,3	1210
750005N	Massey Ferguson	Schlepper / Dronningborg	34	Regler AC		0,5	-3,3	1210
750005N	Massey Ferguson	Schlepper / Dronningborg	36	Regler AC		0,5	-3,3	1210
750005N	Massey Ferguson	Schlepper / Dronningborg	38	Regler AC		0,5	-3,3	1210
750005N	Massey Ferguson	Schlepper / Dronningborg	40	Regler AC		0,5	-3,3	1210
750005N	MC Cormick	Schlepper / CX	70	Regler AC		0,5	-3,3	1210
750005N	MC Cormick	Schlepper / CX	80	Regler AC		0,5	-3,3	1210
750005N	MC Cormick	Schlepper / CX	90	Regler AC		0,5	-3,3	1210
750005N	MC Cormick	Schlepper / CX	100	Regler AC		0,5	-3,3	1210
750005N	MC Cormick	Schlepper / F	90	Regler AC		0,5	-3,3	1210
750005N	MC Cormick	Schlepper / MC	80	Regler AC		0,5	-3,3	1210
750005N	MC Cormick	Schlepper / MC	100	Regler AC		0,5	-3,3	1210
750005N	MC Cormick	Schlepper / MC	115	Regler AC		0,5	-3,3	1210
750005N	MC Cormick	Schlepper / MC	120	Regler AC		0,5	-3,3	1210
750005N	MC Cormick	Schlepper / MC	135	Regler AC		0,5	-3,3	1210
750005N	MC Cormick	Schlepper / MTX	110	Regler AC		0,5	-3,3	1210
750005N	MC Cormick	Schlepper / MTX	120	Regler AC		0,5	-3,3	1210
750005N	MC Cormick	Schlepper / MTX	125	Regler AC		0,5	-3,3	1210
750005N	MC Cormick	Schlepper / MTX	135	Regler AC		0,5	-3,3	1210
750005N	MC Cormick	Schlepper / MTX	140	Regler AC		0,5	-3,3	1210
750005N	MC Cormick	Schlepper / MTX	150	Regler AC		0,5	-3,3	1210
750005N	MC Cormick	Schlepper / MTX	155	Regler AC		0,5	-3,3	1210
750005N	MC Cormick	Schlepper / MTX	165	Regler AC		0,5	-3,3	1210
750005N	MC Cormick	Schlepper / MTX	175	Regler AC		0,5	-3,3	1210
750005N	MC Cormick	Schlepper / MTX	185	Regler AC		0,5	-3,3	1210

Dasis Nr.	Hersteller	Modell	Typ	Spezifikation	Spannung [V]	Einschaltpunkt [°C]	Ausschaltpunkt [°C]	Kapillarrohrlänge [mm]
750005N	MC Cormick	Schlepper / XTX	185	Regler AC		0,5	-3,3	1210
750005N	MC Cormick	Schlepper / XTX	200	Regler AC		0,5	-3,3	1210
750005N	MC Cormick	Schlepper / XTX	215	Regler AC		0,5	-3,3	1210
750005N	MC Cormick	Schlepper / ZTX	230	Regler AC		0,5	-3,3	1210
750005N	MC Cormick	Schlepper / ZTX	260	Regler AC		0,5	-3,3	1210
750005N	MC Cormick	Schlepper / ZTX	280	Regler AC		0,5	-3,3	1210
750005N	MC Cormick	Schlepper Obst Wein / ZTX	ZT230	Regler AC		0,5	-3,3	1210
750005N	MC Cormick	Schlepper Obst Wein / ZTX	ZT260	Regler AC		0,5	-3,3	1210
750005N	MC Cormick	Schlepper Obst Wein / ZTX	ZT280	Regler AC		0,5	-3,3	1210
901812N	NEW HOLLAND	Schlepper / 670-8970	8670	Regler AC				609
901812N	NEW HOLLAND	Schlepper / 670-8970	8770	Regler AC				609
901812N	NEW HOLLAND	Schlepper / 670-8970	8870	Regler AC				609
901812N	NEW HOLLAND	Schlepper / 670-8970	8970	Regler AC				609
901820N	NEW HOLLAND	Schlepper / 2110-8210	2310					
901820N	NEW HOLLAND	Schlepper / 2110-8210	2610					
901820N	NEW HOLLAND	Schlepper / 2110-8210	2810					
901820N	NEW HOLLAND	Schlepper / 2110-8210	2910					
901820N	NEW HOLLAND	Schlepper / 2110-8210	3310					
901820N	NEW HOLLAND	Schlepper / 2110-8210	3610					
901820N	NEW HOLLAND	Schlepper / 2110-8210	3910					
901820N	NEW HOLLAND	Schlepper / 2110-8210	4110					
901820N	NEW HOLLAND	Schlepper / 2110-8210	4610					
901820N	NEW HOLLAND	Schlepper / 2110-8210	5110					
901820N	NEW HOLLAND	Schlepper / 2110-8210	5610					
901820N	NEW HOLLAND	Schlepper / 2110-8210	5710					
901820N	NEW HOLLAND	Schlepper / 2110-8210	5900					
901820N	NEW HOLLAND	Schlepper / 2110-8210	6410					
901820N	NEW HOLLAND	Schlepper / 2110-8210	6610					
901820N	NEW HOLLAND	Schlepper / 2110-8210	6710					
901820N	NEW HOLLAND	Schlepper / 2110-8210	6810					
901820N	NEW HOLLAND	Schlepper / 2110-8210	7410					

Dasis Nr.	Hersteller	Modell	Typ	Spezifikation	Spannung [V]	Einschaltpunkt [°C]	Ausschaltpunkt [°C]	Kapillarrohrlänge [mm]
901820N	NEW HOLLAND	Schlepper / 2110-8210	7610					
901820N	NEW HOLLAND	Schlepper / 2110-8210	7710					
901820N	NEW HOLLAND	Schlepper / 2110-8210	7810					
901820N	NEW HOLLAND	Schlepper / 2110-8210	7910					
901820N	NEW HOLLAND	Schlepper / 2110-8210	8210					
901820N	NEW HOLLAND	Schlepper / 3230-8930	3230					
901820N	NEW HOLLAND	Schlepper / 3230-8930	3430					
901820N	NEW HOLLAND	Schlepper / 3230-8930	3930					
901820N	NEW HOLLAND	Schlepper / 3230-8930	3930H					
901820N	NEW HOLLAND	Schlepper / 3230-8930	4130					
901820N	NEW HOLLAND	Schlepper / 3230-8930	4330					
901820N	NEW HOLLAND	Schlepper / 3230-8930	4630					
901820N	NEW HOLLAND	Schlepper / 3230-8930	4830					
901820N	NEW HOLLAND	Schlepper / 3230-8930	5030					
901820N	NEW HOLLAND	Schlepper / 3230-8930	8530					
901820N	NEW HOLLAND	Schlepper / 3230-8930	8630					
901820N	NEW HOLLAND	Schlepper / 3230-8930	8730					
901820N	NEW HOLLAND	Schlepper / 3230-8930	8830					
901820N	NEW HOLLAND	Schlepper /4110-8210	5110					
901820N	NEW HOLLAND	Schlepper /4110-8210	5610					
901820N	NEW HOLLAND	Schlepper /4110-8210	6410					
901820N	NEW HOLLAND	Schlepper /4110-8210	6610					
901820N	NEW HOLLAND	Schlepper /4110-8210	6810					
901820N	NEW HOLLAND	Schlepper /4110-8210	7410					
901820N	NEW HOLLAND	Schlepper /4110-8210	7610					
901820N	NEW HOLLAND	Schlepper /4110-8210	7710					
901820N	NEW HOLLAND	Schlepper /4110-8210	7810					
901820N	NEW HOLLAND	Schlepper /4110-8210	7910					
901820N	NEW HOLLAND	Schlepper /4110-8210	8210					
901812N	NEW HOLLAND	Schlepper / 8670-8970	8670	Regler AC				609
901812N	NEW HOLLAND	Schlepper / 8670-8970	8770	Regler AC				609
901812N	NEW HOLLAND	Schlepper / 8670-8970	8870	Regler AC				609



Dasis Nr.	Hersteller	Modell	Typ	Spezifikation	Spannung [V]	Einschaltpunkt [°C]	Ausschaltpunkt [°C]	Kapillarrohrlänge [mm]
901812N	NEW HOLLAND	Schlepper / 8670-8970	8970	Regler AC				609
901812N	NEW HOLLAND	Schlepper / 8670A-8970A	8670A	Regler AC				609
901812N	NEW HOLLAND	Schlepper / 8670A-8970A	8770A	Regler AC				609
901812N	NEW HOLLAND	Schlepper / 8670A-8970A	8870A	Regler AC				609
901812N	NEW HOLLAND	Schlepper / 8670A-8970A	8970A	Regler AC				609
750005N	NEW HOLLAND	Schlepper / FW	20	Regler AC		0,5	-3,3	1210
750005N	NEW HOLLAND	Schlepper / FW	30	Regler AC		0,5	-3,3	1210
750005N	NEW HOLLAND	Schlepper / FW	40	Regler AC		0,5	-3,3	1210
750005N	NEW HOLLAND	Schlepper / FW	60	Regler AC		0,5	-3,3	1210
901812N	NEW HOLLAND	Schlepper / G	170	Regler AC				609
901812N	NEW HOLLAND	Schlepper / G	190	Regler AC				609
750005N	NEW HOLLAND	Schlepper / TLA	70A	Regler AC		0,5	-3,3	1210
750005N	NEW HOLLAND	Schlepper / TLA	80A	Regler AC		0,5	-3,3	1210
750005N	NEW HOLLAND	Schlepper / TLA	100A	Regler AC		0,5	-3,3	1210
901812N	NEW HOLLAND	Schlepper / TV	140	Regler AC				609
901812N	NEW HOLLAND	Schlepper / TV	145	Regler AC				609
901808N	Renault	Schlepper / Ceres	65					
901808N	Renault	Schlepper / Ceres	65-4					
901808N	Renault	Schlepper / Ceres	70-70					
901808N	Renault	Schlepper / Ceres	70-70-4					
901808N	Renault	Schlepper / Ceres	75-75					
901808N	Renault	Schlepper / Ceres	75-75-4					
901808N	Renault	Schlepper / Ceres	85-85					
901808N	Renault	Schlepper / Ceres	85-85-4					
901808N	Renault	Schlepper / Ceres	95-95					
901808N	Renault	Schlepper / Ceres	95-95-4					
901808N	Renault	Schlepper / Ceres	310					
901808N	Renault	Schlepper / Ceres	320					
901808N	Renault	Schlepper / Ceres	325					
901808N	Renault	Schlepper / Ceres	330					
901808N	Renault	Schlepper / Ceres	335					
901808N	Renault	Schlepper / Ceres	340					

Dasis Nr.	Hersteller	Modell	Typ	Spezifikation	Spannung [V]	Einschaltpunkt [°C]	Ausschaltpunkt [°C]	Kapillarrohrlänge [mm]
901808N	Renault	Schlepper / Ceres	345					
901808N	Renault	Schlepper / Ceres	355					

Dasis Nr.	Hersteller	Modell	Typ	Ausstattungsvariante
900066N	Bateman	Selbstfahrende Farbspritze / RB	15	
900066N	Bateman	Selbstfahrende Farbspritze / RB	16	
900066N	Bateman	Selbstfahrende Farbspritze / RB	25	
901219N	Case International IHC	Mähdrescher / 16	1620	3 Schaltstufen
901219N	Case International IHC	Mähdrescher / 16	1620E	3 Schaltstufen
901219N	Case International IHC	Mähdrescher / 16	1640	3 Schaltstufen
901219N	Case International IHC	Mähdrescher / 16	1660E	3 Schaltstufen
901219N	Case International IHC	Mähdrescher / 16	1666	3 Schaltstufen
901219N	Case International IHC	Mähdrescher / 16	1670	3 Schaltstufen
901219N	Case International IHC	Mähdrescher / 16	1680E	3 Schaltstufen
901219N	Case International IHC	Mähdrescher 521-1150	715	3 Schaltstufen
901219N	Case International IHC	Mähdrescher 521-1150	815	3 Schaltstufen
901219N	Case International IHC	Mähdrescher 521-1150	915	3 Schaltstufen
901780N	Case International IHC	Schlepper / CX	50	
901653N	Case International IHC	Schlepper / CX	50	3 Schaltstufen
901780N	Case International IHC	Schlepper / CX	60	
901653N	Case International IHC	Schlepper / CX	60	3 Schaltstufen
901780N	Case International IHC	Schlepper / CX	70	
901653N	Case International IHC	Schlepper / CX	70	3 Schaltstufen
901780N	Case International IHC	Schlepper / CX	80	
901653N	Case International IHC	Schlepper / CX	80	3 Schaltstufen
901780N	Case International IHC	Schlepper / CX	90	
901653N	Case International IHC	Schlepper / CX	90	3 Schaltstufen
901780N	Case International IHC	Schlepper / CX	100	
901653N	Case International IHC	Schlepper / CX	100	3 Schaltstufen
901761N	Case International IHC	Schlepper / JX	55	
901761N	Case International IHC	Schlepper / JX	60	
901761N	Case International IHC	Schlepper / JX	65	
901761N	Case International IHC	Schlepper / JX	70	
901761N	Case International IHC	Schlepper / JX	75	
901761N	Case International IHC	Schlepper / JX	80	
901761N	Case International IHC	Schlepper / JX	85	

Dasis Nr.	Hersteller	Modell	Typ	Ausstattungsvariante
901761N	Case International IHC	Schlepper / JX	90	
901761N	Case International IHC	Schlepper / JX	95	
901796N	Case International IHC	Schlepper / MX	100	
901796N	Case International IHC	Schlepper / MX	110	
901796N	Case International IHC	Schlepper / MX	120	
901796N	Case International IHC	Schlepper / MX	135	
901796N	Case International IHC	Schlepper / MX	150	
901796N	Case International IHC	Schlepper / MX	170	
901796N	Case International IHC	Schlepper / MX	180	
901796N	Case International IHC	Schlepper / MX	200	
901780N	Case International IHC	Schlepper / MX	210	
901796N	Case International IHC	Schlepper / MX	220	
901780N	Case International IHC	Schlepper / MX	230	
901796N	Case International IHC	Schlepper / MX	240	
901780N	Case International IHC	Schlepper / MX	255	
901796N	Case International IHC	Schlepper / MX	270	
901780N	Case International IHC	Schlepper / MX	285	
901729N	Case International IHC	Schlepper / MXC	80	
901729N	Case International IHC	Schlepper / MXC	90	
901729N	Case International IHC	Schlepper / MXC	100	
901761N	Case International IHC	Schlepper / MXM	120	
901819N	Case International IHC	Schlepper / MXM	120	
901819N	Case International IHC	Schlepper / MXM	130	
901761N	Case International IHC	Schlepper / MXM	130	
901819N	Case International IHC	Schlepper / MXM	140	
901761N	Case International IHC	Schlepper / MXM	140	
901761N	Case International IHC	Schlepper / MXM	155	
901819N	Case International IHC	Schlepper / MXM	155	
901819N	Case International IHC	Schlepper / MXM	175	
901761N	Case International IHC	Schlepper / MXM	175	
901761N	Case International IHC	Schlepper / MXM	190	
901819N	Case International IHC	Schlepper / MXM	190	

Dasis Nr.	Hersteller	Modell	Typ	Ausstattungsvariante
901816N	Case International IHC	Schlepper / MXU	100	
901573N	Case International IHC	Schlepper / MXU	100	
901710N	Case International IHC	Schlepper / MXU	100	4 Schaltstufen
901816N	Case International IHC	Schlepper / MXU	110	
901573N	Case International IHC	Schlepper / MXU	110	
901710N	Case International IHC	Schlepper / MXU	110	4 Schaltstufen
901573N	Case International IHC	Schlepper / MXU	115	
901816N	Case International IHC	Schlepper / MXU	115	
901710N	Case International IHC	Schlepper / MXU	115	4 Schaltstufen
901573N	Case International IHC	Schlepper / MXU	125	
901816N	Case International IHC	Schlepper / MXU	125	
901710N	Case International IHC	Schlepper / MXU	125	4 Schaltstufen
901573N	Case International IHC	Schlepper / MXU	130	
901710N	Case International IHC	Schlepper / MXU	130	4 Schaltstufen
901816N	Case International IHC	Schlepper / MXU	135	
901710N	Case International IHC	Schlepper / MXU	135	4 Schaltstufen
901263N	Case International IHC	Schlepper / STX	275	3 Schaltstufen
901263N	Case International IHC	Schlepper / STX	325	3 Schaltstufen
901263N	Case International IHC	Schlepper / STX	375	3 Schaltstufen
901263N	Case International IHC	Schlepper / STX	425	3 Schaltstufen
901263N	Case International IHC	Schlepper / STX	440	3 Schaltstufen
901263N	Case International IHC	Schlepper / STX	450	3 Schaltstufen
901263N	Case International IHC	Schlepper / STX	500	3 Schaltstufen
901263N	Case International IHC	Schlepper Obstbau / STX	375	3 Schaltstufen
901263N	Case International IHC	Schlepper Obstbau / STX	425	3 Schaltstufen
901263N	Case International IHC	Schlepper Obstbau / STX	440	3 Schaltstufen
901263N	Case International IHC	Schlepper Obstbau / STX	450	3 Schaltstufen
901263N	Case International IHC	Schlepper Obstbau / STX	500	3 Schaltstufen
900066N	Claas	Mähdrescher / Dominator 6	56	
900056N	Claas	Mähdrescher / Dominator 6	56	
900056N	Claas	Mähdrescher / Dominator 6	66	
900066N	Claas	Mähdrescher / Dominator 6	66	

Dasis Nr.	Hersteller	Modell	Typ	Ausstattungsvariante
900066N	Claas	Mähdrescher / Dominator 6	76	
900056N	Claas	Mähdrescher / Dominator 6	76	
900066N	Claas	Mähdrescher / Dominator 6	86	
900056N	Claas	Mähdrescher / Dominator 6	86	
900066N	Claas	Mähdrescher / Dominator 6	96	
900056N	Claas	Mähdrescher / Dominator 6	96	
900056N	Claas	Mähdrescher / Dominator 6	106	
900066N	Claas	Mähdrescher / Dominator 6	106	
900066N	Claas	Mähdrescher / Dominator 6	116	
900056N	Claas	Mähdrescher / Dominator 6	116	
901219N	Claas	Schlepper	Diverse	3 Schaltstufen
900076N	Deutz	Schlepper / DX	85	3 Schaltstufen
900076N	Deutz	Schlepper / DX	90	3 Schaltstufen
900076N	Deutz	Schlepper / DX	92	3 Schaltstufen
900076N	Deutz	Schlepper / DX	110	3 Schaltstufen
900076N	Deutz	Schlepper / DX	120	3 Schaltstufen
900076N	Deutz	Schlepper / DX3	3.10	3 Schaltstufen
900076N	Deutz	Schlepper / DX3	3.30	3 Schaltstufen
900076N	Deutz	Schlepper / DX3	3.50	3 Schaltstufen
900076N	Deutz	Schlepper / DX3	3.60	3 Schaltstufen
900076N	Deutz	Schlepper / DX3	3.65	3 Schaltstufen
900076N	Deutz	Schlepper / DX3	3.70	3 Schaltstufen
900076N	Deutz	Schlepper / DX3	3.80	3 Schaltstufen
900076N	Deutz	Schlepper / DX3	3.90	3 Schaltstufen
900076N	Deutz	Schlepper / DX4	4.10	3 Schaltstufen
900076N	Deutz	Schlepper / DX4	4.30	3 Schaltstufen
900076N	Deutz	Schlepper / DX4	4.50	3 Schaltstufen
900076N	Deutz	Schlepper / DX4	4.70	3 Schaltstufen
900076N	Deutz	Schlepper / DX6	6.05	3 Schaltstufen
900076N	Deutz	Schlepper / DX6	6.10	3 Schaltstufen
900076N	Deutz	Schlepper / DX6	6.30	3 Schaltstufen
900076N	Deutz	Schlepper / DX6	6.50	3 Schaltstufen

Dasis Nr.	Hersteller	Modell	Typ	Ausstattungsvariante
900076N	Deutz	Schlepper / DX7	7.10	3 Schaltstufen
900076N	Deutz	Schlepper / DX8	8.30	3 Schaltstufen
900194N	Fendt	Schlepper / Farmer 300	303	
900194N	Fendt	Schlepper / Farmer 300	303LS	
900194N	Fendt	Schlepper / Farmer 300	303LSA	
900194N	Fendt	Schlepper / Farmer 300	304	
900194N	Fendt	Schlepper / Farmer 300	304LS	
900194N	Fendt	Schlepper / Farmer 300	304LSA	
900194N	Fendt	Schlepper / Farmer 300	305	
900194N	Fendt	Schlepper / Farmer 300	305LS	
900194N	Fendt	Schlepper / Farmer 300	305LSA	
900194N	Fendt	Schlepper / Farmer 300	306	
900194N	Fendt	Schlepper / Farmer 300	306LS	
900194N	Fendt	Schlepper / Farmer 300	306LSA	
900194N	Fendt	Schlepper / Farmer 300	307	
900194N	Fendt	Schlepper / Farmer 300	307LS	
900194N	Fendt	Schlepper / Farmer 300	307LSA	
900194N	Fendt	Schlepper / Farmer 300	307LSE	
900194N	Fendt	Schlepper / Farmer 300	308	
900194N	Fendt	Schlepper / Farmer 300	308LS	
900194N	Fendt	Schlepper / Farmer 300	308LSA	
900194N	Fendt	Schlepper / Farmer 300	308LSE	
900194N	Fendt	Schlepper / Farmer 300	309	
900194N	Fendt	Schlepper / Farmer 300	309LS	
900194N	Fendt	Schlepper / Farmer 300	309LSA	
900194N	Fendt	Schlepper / Farmer 300	309LSE	
900194N	Fendt	Schlepper / Farmer 300	310	
900194N	Fendt	Schlepper / Farmer 300	310LSA	
900194N	Fendt	Schlepper / Farmer 300	310LSE	
900194N	Fendt	Schlepper / Farmer 300	311	
900194N	Fendt	Schlepper / Farmer 300	311LSA	
900194N	Fendt	Schlepper / Farmer 300	311LSE	

Dasis Nr.	Hersteller	Modell	Typ	Ausstattungsvariante
900194N	Fendt	Schlepper / Farmer 300	312	
900194N	Fendt	Schlepper / Farmer 300	312LSA	
900194N	Fendt	Schlepper / Farmer 300	312LSE	
900194N	Fendt	Schlepper / Favorit 500	509	
900194N	Fendt	Schlepper / Favorit 500	509C	
900194N	Fendt	Schlepper / Favorit 500	510	
901219N	Fiat / Hitachi	Schlepper / G	170	3 Schaltstufen
901219N	Fiat / Hitachi	Schlepper / G	190	3 Schaltstufen
901219N	Fiat / Hitachi	Schlepper / G	210	3 Schaltstufen
901219N	Fiat / Hitachi	Schlepper / G	240	3 Schaltstufen
901819N	Fiat / Hitachi	Schlepper / M	100	
901819N	Fiat / Hitachi	Schlepper / M	115	
901819N	Fiat / Hitachi	Schlepper / M	135	
901819N	Fiat / Hitachi	Schlepper / M	160	
901819N	Fiat / Hitachi	Schlepper / M	180	
900887N	John Deere	Feldhäcksler / 5030-5730	5720	
900887N	John Deere	Feldhäcksler / 6010-6950	6610	
900887N	John Deere	Feldhäcksler / 6010-6950	6710	
900887N	John Deere	Feldhäcksler / 6010-6950	6810	
900887N	John Deere	Feldhäcksler / 6010-6950	6910	
900056N	Massey Ferguson	Mähdrescher / MF 24-40	27	
900056N	Massey Ferguson	Mähdrescher / MF 24-40	29	
900056N	Massey Ferguson	Mähdrescher / MF 24-40	31	
901060N	Massey Ferguson	Schlepper / 500	550	3 Schaltstufen
901060N	Massey Ferguson	Schlepper / 500	560	3 Schaltstufen
901060N	Massey Ferguson	Schlepper / 500	565	3 Schaltstufen
901060N	Massey Ferguson	Schlepper / 500	575	3 Schaltstufen
901060N	Massey Ferguson	Schlepper / 500	590	3 Schaltstufen
901060N	Massey Ferguson	Schlepper / 500	592	3 Schaltstufen
901060N	Massey Ferguson	Schlepper / 500	595	3 Schaltstufen
901060N	Massey Ferguson	Schlepper / 500	595K	3 Schaltstufen
901814N	Massey Ferguson	Schlepper / 4000	4215	



Dasis Nr.	Hersteller	Modell	Typ	Ausstattungsvariante
901814N	Massey Ferguson	Schlepper / 4000	4220	
901814N	Massey Ferguson	Schlepper / 4000	4225	
901814N	Massey Ferguson	Schlepper / 4000	4235	
901814N	Massey Ferguson	Schlepper / 4000	4240	
901814N	Massey Ferguson	Schlepper / 4000	4243	
901814N	Massey Ferguson	Schlepper / 4000	4245	
901814N	Massey Ferguson	Schlepper / 4000	4253	
901814N	Massey Ferguson	Schlepper / 4000	4255	
901814N	Massey Ferguson	Schlepper / 4000	4260	
901814N	Massey Ferguson	Schlepper / 4000	4263	
901814N	Massey Ferguson	Schlepper / 4000	4265	
901814N	Massey Ferguson	Schlepper / 4000	4270	
901814N	Massey Ferguson	Schlepper / 4000	4325	
901814N	Massey Ferguson	Schlepper / 4000	4335	
901814N	Massey Ferguson	Schlepper / 4000	4345	
901814N	Massey Ferguson	Schlepper / 4000	4355	
901818N	Massey Ferguson	Schlepper / 5000	5425	
901814N	Massey Ferguson	Schlepper / 5000	5425	
901814N	Massey Ferguson	Schlepper / 5000	5435	
901818N	Massey Ferguson	Schlepper / 5000	5435	
901814N	Massey Ferguson	Schlepper / 5000	5445	
901818N	Massey Ferguson	Schlepper / 5000	5445	
901814N	Massey Ferguson	Schlepper / 5000	5455	
901818N	Massey Ferguson	Schlepper / 5000	5455	
901814N	Massey Ferguson	Schlepper / 5000	5460	
901818N	Massey Ferguson	Schlepper / 5000	5460	
901818N	Massey Ferguson	Schlepper / 5000	5465	
901814N	Massey Ferguson	Schlepper / 5000	5465 HI-Visibility	
901814N	Massey Ferguson	Schlepper / 5000	5470	
901818N	Massey Ferguson	Schlepper / 5000	5470	
901814N	Massey Ferguson	Schlepper / 5000	5480	
901818N	Massey Ferguson	Schlepper / 5000	5480	

Dasis Nr.	Hersteller	Modell	Typ	Ausstattungsvariante
901814N	Massey Ferguson	Schlepper / 6000	6110	
901814N	Massey Ferguson	Schlepper / 6000	6120	
901814N	Massey Ferguson	Schlepper / 6000	6130	
901814N	Massey Ferguson	Schlepper / 6000	6140	
901814N	Massey Ferguson	Schlepper / 6000	6150	
901814N	Massey Ferguson	Schlepper / 6000	6160	
901814N	Massey Ferguson	Schlepper / 6000	6170	
901814N	Massey Ferguson	Schlepper / 6000	6180	
901814N	Massey Ferguson	Schlepper / 6000	6190	
901814N	Massey Ferguson	Schlepper / 6000	6235	
901814N	Massey Ferguson	Schlepper / 6000	6245	
901814N	Massey Ferguson	Schlepper / 6000	6255	
901814N	Massey Ferguson	Schlepper / 6000	6260	
901814N	Massey Ferguson	Schlepper / 6000	6265	
901814N	Massey Ferguson	Schlepper / 6000	6270	
901814N	Massey Ferguson	Schlepper / 6000	6280	
901814N	Massey Ferguson	Schlepper / 6000	6290	
901818N	Massey Ferguson	Schlepper / 6000	6445	
901818N	Massey Ferguson	Schlepper / 6000	6455	
901818N	Massey Ferguson	Schlepper / 6000	6460	
901818N	Massey Ferguson	Schlepper / 6000	6465	
901814N	Massey Ferguson	Schlepper / 6000	6465	
901818N	Massey Ferguson	Schlepper / 6000	6470	
901818N	Massey Ferguson	Schlepper / 6000	6475	
901814N	Massey Ferguson	Schlepper / 6000	6475	
901818N	Massey Ferguson	Schlepper / 6000	6480	
901814N	Massey Ferguson	Schlepper / 6000	6480	
901818N	Massey Ferguson	Schlepper / 6000	6485	
901814N	Massey Ferguson	Schlepper / 6000	6485	
901814N	Massey Ferguson	Schlepper / 6000	6490	
901818N	Massey Ferguson	Schlepper / 6000	6490	
901818N	Massey Ferguson	Schlepper / 6000	6495	

Dasis Nr.	Hersteller	Modell	Typ	Ausstattungsvariante
901814N	Massey Ferguson	Schlepper / 6000	6495	
901818N	Massey Ferguson	Schlepper / 6000	6497	
901818N	Massey Ferguson	Schlepper / 6000	6499	
901818N	Massey Ferguson	Schlepper / 7000	7465	
901818N	Massey Ferguson	Schlepper / 7000	7475	
901818N	Massey Ferguson	Schlepper / 7000	7480	
901818N	Massey Ferguson	Schlepper / 7000	7485	
901818N	Massey Ferguson	Schlepper / 7000	7490	
901818N	Massey Ferguson	Schlepper / 7000	7495	
901818N	Massey Ferguson	Schlepper / 7000	7495Räder3	
901814N	Massey Ferguson	Schlepper / 8000	8110	
901814N	Massey Ferguson	Schlepper / 8000	8120	
901814N	Massey Ferguson	Schlepper / 8000	8130	
901814N	Massey Ferguson	Schlepper / 8000	8140	
901814N	Massey Ferguson	Schlepper / 8000	8150	
901814N	Massey Ferguson	Schlepper / 8000	8160	
901814N	Massey Ferguson	Schlepper / 8000	8170	
901814N	Massey Ferguson	Schlepper / 8000	8180	
901814N	Massey Ferguson	Schlepper / 8000	8210	
901814N	Massey Ferguson	Schlepper / 8000	8220	
901814N	Massey Ferguson	Schlepper / 8000	8240	
901814N	Massey Ferguson	Schlepper / 8000	8250	
901814N	Massey Ferguson	Schlepper / 8000	8260	
901814N	Massey Ferguson	Schlepper / 8000	8270	
901814N	Massey Ferguson	Schlepper / 8000	8280	
901818N	Massey Ferguson	Schlepper Obst Wein / 8400	8450	
901818N	Massey Ferguson	Schlepper Obst Wein / 8400	8460	
901818N	Massey Ferguson	Schlepper Obst Wein / 8400	8470	
901818N	Massey Ferguson	Schlepper Obst Wein / 8400	8480	
901219N	MC Cormick	Schlepper / CX	70	3 Schaltstufen
901219N	MC Cormick	Schlepper / CX	80	3 Schaltstufen
901219N	MC Cormick	Schlepper / CX	90	3 Schaltstufen

Dasis Nr.	Hersteller	Modell	Typ	Ausstattungsvariante
901219N	MC Cormick	Schlepper / CX	100	3 Schaltstufen
901219N	MC Cormick	Schlepper / MC	80	3 Schaltstufen
901219N	MC Cormick	Schlepper / MC	90	3 Schaltstufen
901219N	MC Cormick	Schlepper / MC	100	3 Schaltstufen
901219N	MC Cormick	Schlepper / MC	115	3 Schaltstufen
901219N	MC Cormick	Schlepper / MC	120	3 Schaltstufen
901219N	MC Cormick	Schlepper / MC	135	3 Schaltstufen
901219N	MC Cormick	Schlepper / MTX	110	3 Schaltstufen
901219N	MC Cormick	Schlepper / MTX	120	3 Schaltstufen
901219N	MC Cormick	Schlepper / MTX	125	3 Schaltstufen
901219N	MC Cormick	Schlepper / MTX	135	3 Schaltstufen
901219N	MC Cormick	Schlepper / MTX	140	3 Schaltstufen
901219N	MC Cormick	Schlepper / MTX	150	3 Schaltstufen
901219N	MC Cormick	Schlepper / MTX	155	3 Schaltstufen
901219N	MC Cormick	Schlepper / MTX	165	3 Schaltstufen
901219N	MC Cormick	Schlepper / MTX	175	3 Schaltstufen
901219N	MC Cormick	Schlepper / MTX	185	3 Schaltstufen
901219N	MC Cormick	Schlepper / XTX	185	3 Schaltstufen
901219N	MC Cormick	Schlepper / XTX	200	3 Schaltstufen
901219N	MC Cormick	Schlepper / XTX	215	3 Schaltstufen
901219N	MC Cormick	Schlepper / ZTX	230	3 Schaltstufen
901219N	MC Cormick	Schlepper / ZTX	260	3 Schaltstufen
901219N	MC Cormick	Schlepper / ZTX	280	3 Schaltstufen
901219N	NEW HOLLAND	Baggerlader / 550-575E	555	3 Schaltstufen
901219N	NEW HOLLAND	Baggerlader / 550-575E	555A	3 Schaltstufen
901219N	NEW HOLLAND	Baggerlader / 550-575E	555B	3 Schaltstufen
901219N	NEW HOLLAND	Baggerlader / 550-575E	575	3 Schaltstufen
901219N	NEW HOLLAND	Baggerlader / 655-755A	655	3 Schaltstufen
901219N	NEW HOLLAND	Baggerlader / 655-755A	655A	3 Schaltstufen
901219N	NEW HOLLAND	Baggerlader / 655-755A	675	3 Schaltstufen
901219N	NEW HOLLAND	Baggerlader / 655-755A	755A	3 Schaltstufen
901219N	NEW HOLLAND	Schlepper / 670-8970	8670	3 Schaltstufen

Dasis Nr.	Hersteller	Modell	Typ	Ausstattungsvariante
901219N	NEW HOLLAND	Schlepper / 670-8970	8770	3 Schaltstufen
901219N	NEW HOLLAND	Schlepper / 670-8970	8870	3 Schaltstufen
901219N	NEW HOLLAND	Schlepper / 670-8970	8970	3 Schaltstufen
901806N	NEW HOLLAND	Schlepper / 3435-7635	3435	
901806N	NEW HOLLAND	Schlepper / 3435-7635	3935	
901806N	NEW HOLLAND	Schlepper / 3435-7635	4135	
901806N	NEW HOLLAND	Schlepper / 3435-7635	4635	
901806N	NEW HOLLAND	Schlepper / 3435-7635	4835	
901806N	NEW HOLLAND	Schlepper / 3435-7635	5635	
901806N	NEW HOLLAND	Schlepper / 3435-7635	6635	
901806N	NEW HOLLAND	Schlepper / 3435-7635	7635	
901761N	NEW HOLLAND	Schlepper / 4140-8340	5640	
901819N	NEW HOLLAND	Schlepper / 4140-8340	5640	
901219N	NEW HOLLAND	Schlepper / 4140-8340	5640	3 Schaltstufen
901761N	NEW HOLLAND	Schlepper / 4140-8340	6640	
901819N	NEW HOLLAND	Schlepper / 4140-8340	6640	
901219N	NEW HOLLAND	Schlepper / 4140-8340	6640	3 Schaltstufen
901819N	NEW HOLLAND	Schlepper / 4140-8340	7740	
901761N	NEW HOLLAND	Schlepper / 4140-8340	7740	
901219N	NEW HOLLAND	Schlepper / 4140-8340	7740	3 Schaltstufen
901819N	NEW HOLLAND	Schlepper / 4140-8340	7840	
901761N	NEW HOLLAND	Schlepper / 4140-8340	7840	
901219N	NEW HOLLAND	Schlepper / 4140-8340	7840	3 Schaltstufen
901761N	NEW HOLLAND	Schlepper / 4140-8340	8240	
901819N	NEW HOLLAND	Schlepper / 4140-8340	8240	
901219N	NEW HOLLAND	Schlepper / 4140-8340	8240	3 Schaltstufen
901819N	NEW HOLLAND	Schlepper / 4140-8340	8340	
901761N	NEW HOLLAND	Schlepper / 4140-8340	8340	
901219N	NEW HOLLAND	Schlepper / 4140-8340	8340	3 Schaltstufen
901819N	NEW HOLLAND	Schlepper / 8160-8560	8160	
901804N	NEW HOLLAND	Schlepper / 8160-8560	8160	
901819N	NEW HOLLAND	Schlepper / 8160-8560	8260	

Dasis Nr.	Hersteller	Modell	Typ	Ausstattungsvariante
901804N	NEW HOLLAND	Schlepper / 8160-8560	8260	
901804N	NEW HOLLAND	Schlepper / 8160-8560	8360	
901819N	NEW HOLLAND	Schlepper / 8160-8560	8360	
901819N	NEW HOLLAND	Schlepper / 8160-8560	8560	
901804N	NEW HOLLAND	Schlepper / 8160-8560	8560	
901219N	NEW HOLLAND	Schlepper / 8670-8970	8670	3 Schaltstufen
901219N	NEW HOLLAND	Schlepper / 8670-8970	8770	3 Schaltstufen
901219N	NEW HOLLAND	Schlepper / 8670-8970	8870	3 Schaltstufen
901219N	NEW HOLLAND	Schlepper / 8670-8970	8970	3 Schaltstufen
901219N	NEW HOLLAND	Schlepper / 8670A-8970A	8670A	3 Schaltstufen
901219N	NEW HOLLAND	Schlepper / 8670A-8970A	8770A	3 Schaltstufen
901219N	NEW HOLLAND	Schlepper / 8670A-8970A	8870A	3 Schaltstufen
901219N	NEW HOLLAND	Schlepper / 8670A-8970A	8970A	3 Schaltstufen
901219N	NEW HOLLAND	Schlepper / G	170	3 Schaltstufen
901219N	NEW HOLLAND	Schlepper / G	190	3 Schaltstufen
901263N	NEW HOLLAND	Schlepper / TG	210	3 Schaltstufen
901263N	NEW HOLLAND	Schlepper / TG	230	3 Schaltstufen
901263N	NEW HOLLAND	Schlepper / TG	255	3 Schaltstufen
901263N	NEW HOLLAND	Schlepper / TG	285	3 Schaltstufen
901806N	NEW HOLLAND	Schlepper / TL	70	
901806N	NEW HOLLAND	Schlepper / TL	80	
901806N	NEW HOLLAND	Schlepper / TL	90	
901806N	NEW HOLLAND	Schlepper / TL	100	
901819N	NEW HOLLAND	Schlepper / TM	TM115	
901819N	NEW HOLLAND	Schlepper / TM	TM120	
901819N	NEW HOLLAND	Schlepper / TM	TM125	
901819N	NEW HOLLAND	Schlepper / TM	TM130	
901819N	NEW HOLLAND	Schlepper / TM	TM135	
901819N	NEW HOLLAND	Schlepper / TM	TM140	
901819N	NEW HOLLAND	Schlepper / TM	TM150	
901819N	NEW HOLLAND	Schlepper / TM	TM155	
901819N	NEW HOLLAND	Schlepper / TM	TM165	

Dasis Nr.	Hersteller	Modell	Typ	Ausstattungsvariante
901819N	NEW HOLLAND	Schlepper / TM	TM175	
901819N	NEW HOLLAND	Schlepper / TM	TM190	
901819N	NEW HOLLAND	Schlepper / TS	80	
901819N	NEW HOLLAND	Schlepper / TS	90	
901819N	NEW HOLLAND	Schlepper / TS	100	
901819N	NEW HOLLAND	Schlepper / TS	110	
901819N	NEW HOLLAND	Schlepper / TS	115	
901816N	NEW HOLLAND	Schlepper / TSA	100A	
901710N	NEW HOLLAND	Schlepper / TSA	100A	4 Schaltstufen
901816N	NEW HOLLAND	Schlepper / TSA	110A	
901710N	NEW HOLLAND	Schlepper / TSA	110A	4 Schaltstufen
901816N	NEW HOLLAND	Schlepper / TSA	115A	
901710N	NEW HOLLAND	Schlepper / TSA	115A	4 Schaltstufen
901816N	NEW HOLLAND	Schlepper / TSA	125A	
901710N	NEW HOLLAND	Schlepper / TSA	125A	4 Schaltstufen
901816N	NEW HOLLAND	Schlepper / TSA	135A	
901710N	NEW HOLLAND	Schlepper / TSA	135A	4 Schaltstufen
900744N	NEW HOLLAND	Schlepper Wein Obst / TN	55	3 Schaltstufen
900744N	NEW HOLLAND	Schlepper Wein Obst / TN	65	3 Schaltstufen
900744N	NEW HOLLAND	Schlepper Wein Obst / TN	70	3 Schaltstufen
900744N	NEW HOLLAND	Schlepper Wein Obst / TN	75	3 Schaltstufen
901809N	NEW HOLLAND	Schlepper Wein Obst / TND	55	
900744N	NEW HOLLAND	Schlepper Wein Obst / TND	55	3 Schaltstufen
901809N	NEW HOLLAND	Schlepper Wein Obst / TND	65	
900744N	NEW HOLLAND	Schlepper Wein Obst / TND	65	3 Schaltstufen
901809N	NEW HOLLAND	Schlepper Wein Obst / TND	70	
900744N	NEW HOLLAND	Schlepper Wein Obst / TND	70	3 Schaltstufen
901809N	NEW HOLLAND	Schlepper Wein Obst / TND	75	
900744N	NEW HOLLAND	Schlepper Wein Obst / TND	75	3 Schaltstufen
900744N	NEW HOLLAND	Schlepper Wein Obst / TNF	65	3 Schaltstufen
900744N	NEW HOLLAND	Schlepper Wein Obst / TNF	70	3 Schaltstufen
900744N	NEW HOLLAND	Schlepper Wein Obst / TNF	75	3 Schaltstufen

Dasis Nr.	Hersteller	Modell	Typ	Ausstattungsvariante
900744N	NEW HOLLAND	Schlepper Wein Obst / TNF	80	3 Schaltstufen
900744N	NEW HOLLAND	Schlepper Wein Obst / TNF	90	3 Schaltstufen
900744N	NEW HOLLAND	Schlepper Wein Obst / TNF	95	3 Schaltstufen
900744N	NEW HOLLAND	Schlepper Wein Obst / TNS	55	3 Schaltstufen
900744N	NEW HOLLAND	Schlepper Wein Obst / TNS	65	3 Schaltstufen
900744N	NEW HOLLAND	Schlepper Wein Obst / TNS	70	3 Schaltstufen
900744N	NEW HOLLAND	Schlepper Wein Obst / TNS	75	3 Schaltstufen
900076N	NEW HOLLAND	Teleskoplader / 4400	4430	3 Schaltstufen



Dasis Nr.	Hersteller	Modell	Typ	Außendurchmesser [mm]	Länge [mm]	Innengewinde 1 [mm]	Außengewinde 1 [mm]	für OE-Nummer
800032N	Agco	Feldspritze DT	225	76				
801240N	Agco	Raupen Dozer / MT	T425	67			15,7	
801240N	Agco	Raupen Dozer / MT	T425B	67			15,7	
801240N	Agco	Raupen Dozer / MT	T434	67			15,7	
801240N	Agco	Raupen Dozer / MT	T444	67			15,7	
801240N	Agco	Raupen Dozer / MT	T445	67			15,7	
801240N	Agco	Raupen Dozer / MT	T445B	67			15,7	
801240N	Agco	Raupen Dozer / MT	T454	67			15,7	
801240N	Agco	Raupen Dozer / MT	T455	67			15,7	
801240N	Agco	Raupen Dozer / MT	T455B	67			15,7	
801240N	Agco	Raupen Dozer / MT	T465	67			15,7	
801240N	Agco	Raupen Dozer / MT	T465B	67			15,7	
801240N	Agco	Raupen Dozer / MT	T525B	67			15,7	
801240N	Agco	Raupen Dozer / MT	T535	67			15,7	
801240N	Agco	Raupen Dozer / MT	T545	67			15,7	
801240N	Agco	Raupen Dozer / MT	T545B	67			15,7	
801240N	Agco	Raupen Dozer / MT	T553B	67			15,7	
801240N	Agco	Raupen Dozer / MT	T555B	67			15,7	
801240N	Agco	Raupen Dozer / MT	T565	67			15,7	
801240N	Agco	Raupen Dozer / MT	T565B	67			15,7	
801240N	Agco	Raupen Dozer / MT	T575B	67			15,7	
801240N	Agco	Raupen Dozer / MT	T635	67			15,7	
801240N	Agco	Raupen Dozer / MT	T645	67			15,7	
801240N	Agco	Raupen Dozer / MT	T655	67			15,7	
801240N	Agco	Raupen Dozer / MT	T665	67			15,7	
800536N	Agco	Raupen Dozer / MT	T700	89		9		
800536N	Agco	Raupen Dozer / MT	T800	89		9		
800433N	Agco	Schlepper / Acgo Star	8360	70				
800433N	Agco	Schlepper / Acgo Star	8425	70				
800367N	Agco	Selbstfahrende Farbspritze / Rogator 600-874	654	75				
800367N	Agco	Selbstfahrende Farbspritze / Rogator 600-874	664	75				

Dasis Nr.	Hersteller	Modell	Typ	Außendurchmesser [mm]	Länge [mm]	Innengewinde 1 [mm]	Außengewinde 1 [mm]	für OE-Nummer
800055N	Agco	Selbstfahrende Farbspritze / Rogator 600-874	844	76			15,6	
800055N	Agco	Selbstfahrende Farbspritze / Rogator 600-874	854	76			15,6	
800055N	Agco	Selbstfahrende Farbspritze / Rogator 600-874	864	76			15,6	
800055N	Agco	Selbstfahrende Farbspritze / Rogator 600-874	874	76			15,6	
800055N	Agco	Selbstfahrende Farbspritze / Rogator 1000	1054	76			15,6	
800055N	Agco	Selbstfahrende Farbspritze / Rogator 1000	1064	76			15,6	
800055N	Agco	Selbstfahrende Farbspritze / Rogator 1000	1074	76			15,6	
800055N	Agco	Selbstfahrende Farbspritze / Rogator 1000	1254	76			15,6	
800055N	Agco	Selbstfahrende Farbspritze / Rogator 1000	1264	76			15,6	
800055N	Agco	Selbstfahrende Farbspritze / Rogator 1000	1274	76			15,6	
800055N	Agco	Selbstfahrende Farbspritze / Terragator 1000	1603	76			15,6	
800371N	Agco	Selbstfahrende Farbspritze / Terragator 1000	1603T	65			16	
800365N	Agco	Selbstfahrende Farbspritze / Terragator 1000	1603T	76				
800055N	Agco	Selbstfahrende Farbspritze / Terragator 1000	1844	76			15,6	
800055N	Agco	Selbstfahrende Farbspritze / Terragator 2000	2505	76			15,6	
800055N	Agco	Selbstfahrende Farbspritze / Terragator 3000	3104	76			15,6	
800055N	Agco	Selbstfahrende Farbspritze / Terragator 6000	6103	76			15,6	
800055N	Agco	Selbstfahrende Farbspritze / Terragator 8000	8103	76			15,6	
800055N	Agco	Selbstfahrende Farbspritze / Terragator 8000	8104	76			15,6	
800055N	Agco	Selbstfahrende Farbspritze / Terragator 9000	9103	76			15,6	
800055N	Agco	Selbstfahrende Farbspritze / Terragator 9000	9105	76			15,6	

Dasis Nr.	Hersteller	Modell	Typ	Außendurchmesser [mm]	Länge [mm]	Innengewinde 1 [mm]	Außengewinde 1 [mm]	für OE-Nummer
802110N	Bateman	Selbstfahrende Farbspritze / RB	15	63,5			11	
802110N	Bateman	Selbstfahrende Farbspritze / RB	16	63,5			11	
802110N	Bateman	Selbstfahrende Farbspritze / RB	25	63,5			11	
800248N	Braud NH	Selbstfahrende Farbspritze / SB	33	63,5				
800248N	Braud NH	Selbstfahrende Farbspritze / SB	35	63,5				
800248N	Braud NH	Selbstfahrende Farbspritze / SB	36	63,5				
800248N	Braud NH	Selbstfahrende Farbspritze / SB	52	63,5				
800248N	Braud NH	Selbstfahrende Farbspritze / SB	53	63,5				
800248N	Braud NH	Selbstfahrende Farbspritze / SB	54	63,5				
800248N	Braud NH	Selbstfahrende Farbspritze / SB	55	63,5				
800248N	Braud NH	Selbstfahrende Farbspritze / SB	56	63,5				
800248N	Braud NH	Selbstfahrende Farbspritze / SB	58	63,5				
800248N	Braud NH	Selbstfahrende Farbspritze / SB	60	63,5				
800248N	Braud NH	Selbstfahrende Farbspritze / SB	62	63,5				
800248N	Braud NH	Selbstfahrende Farbspritze / SB	64	63,5				
800248N	Braud NH	Selbstfahrende Farbspritze / SB	65	63,5				
800248N	Braud NH	Selbstfahrende Farbspritze / TB	10	63,5				
800248N	Braud NH	Selbstfahrende Farbspritze / TB	15	63,5				
800248N	Braud NH	Selbstfahrende Farbspritze / VL	610	63,5				
800248N	Braud NH	Selbstfahrende Farbspritze / VL	620	63,5				
800248N	Braud NH	Selbstfahrende Farbspritze / VL	630	63,5				

Dasis Nr.	Hersteller	Modell	Typ	Außendurchmesser [mm]	Länge [mm]	Innengewinde 1 [mm]	Außengewinde 1 [mm]	für OE-Nummer
800248N	Braud NH	Selbstfahrende Farbspritze / VL	640	63,5				
800248N	Braud NH	Selbstfahrende Farbspritze / VL	660	63,5				
800248N	Braud NH	Selbstfahrende Farbspritze / VN	240	63,5				
800248N	Braud NH	Selbstfahrende Farbspritze / VN	260	63,5				
800543N	Case International IHC	Baggerlader	580	70			10	
800543N	Case International IHC	Baggerlader	580K	70			10	
800018N	Case International IHC	Baggerlader	580L	102		14	16	
800543N	Case International IHC	Baggerlader	580Super	70			10	
800543N	Case International IHC	Baggerlader	580SuperE	70			10	
800018N	Case International IHC	Baggerlader	580SuperK	102		14	16	
800018N	Case International IHC	Baggerlader	580SuperL	102		14	16	
800543N	Case International IHC	Baggerlader	581Super	70			10	
800018N	Case International IHC	Baggerlader	581SuperK	102		14	16	
800018N	Case International IHC	Baggerlader	590SuperL	102		14	16	
800018N	Case International IHC	Baggerlader	590Turbo	102		14	16	
800018N	Case International IHC	Baggerlader	591Turbo	102		14	16	
800543N	Case International IHC	Baggerlader	680H	70			10	
800543N	Case International IHC	Baggerlader	680K	70			10	
800543N	Case International IHC	Baggerlader	680L	70			10	
800018N	Case International IHC	Baggerlader	680L	102		14	16	
800543N	Case International IHC	Baggerlader	780	70			10	
800018N	Case International IHC	Baggerlader	780	102		14	16	
800543N	Case International IHC	Baggerlader	780B	70			10	
800707N	Case International IHC	Baggerlader / CX	75CSR	60	260			47759097 KHR13590
800707N	Case International IHC	Baggerlader / CX	80C	60	260			47759097 KHR13590
800707N	Case International IHC	Baggerlader / CX	130B	60	260			47759097 KHR13590
800707N	Case International IHC	Baggerlader / CX	130C	60	260			47759097 KHR13590
800707N	Case International IHC	Baggerlader / CX	130D	60	260			47759097 KHR13590
800707N	Case International IHC	Baggerlader / CX	130D LC	60	260			47759097 KHR13590
800707N	Case International IHC	Baggerlader / CX	145CSR	60	260			47759097 KHR13590

Dasis Nr.	Hersteller	Modell	Typ	Außendurchmesser [mm]	Länge [mm]	Innengewinde 1 [mm]	Außengewinde 1 [mm]	für OE-Nummer
800707N	Case International IHC	Baggerlader / CX	145D SR	60	260			47759097 KHR13590
800707N	Case International IHC	Baggerlader / CX	145D SR LC	60	260			47759097 KHR13590
800707N	Case International IHC	Baggerlader / CX	160B	60	260			47759097 KHR13590
800707N	Case International IHC	Baggerlader / CX	160C	60	260			47759097 KHR13590
800707N	Case International IHC	Baggerlader / CX	160D LC	60	260			47759097 KHR13590
800707N	Case International IHC	Baggerlader / CX	180B	60	260			47759097 KHR13590
800707N	Case International IHC	Baggerlader / CX	180C	60	260			47759097 KHR13590
800707N	Case International IHC	Baggerlader / CX	180D LC	60	260			47759097 KHR13590
800707N	Case International IHC	Baggerlader / CX	210B	60	260			47759097 KHR13590
800707N	Case International IHC	Baggerlader / CX	210C	60	260			47759097 KHR13590
800707N	Case International IHC	Baggerlader / CX	210D LC	60	260			47759097 KHR13590
800707N	Case International IHC	Baggerlader / CX	210D LC LR	60	260			47759097 KHR13590
800707N	Case International IHC	Baggerlader / CX	210D NLC	60	260			47759097 KHR13590
800707N	Case International IHC	Baggerlader / CX	210D NLC 2PB	60	260			47759097 KHR13590
800707N	Case International IHC	Baggerlader / CX	220B	60	260			47759097 KHR13590
800707N	Case International IHC	Baggerlader / CX	220C	60	260			47759097 KHR13590
800707N	Case International IHC	Baggerlader / CX	230B	60	260			47759097 KHR13590
800707N	Case International IHC	Baggerlader / CX	230C NHD	60	260			47759097 KHR13590
800707N	Case International IHC	Baggerlader / CX	230D NLC	60	260			47759097 KHR13590
800707N	Case International IHC	Baggerlader / CX	235CSR	60	260			47759097 KHR13590
800707N	Case International IHC	Baggerlader / CX	240B	60	260			47759097 KHR13590
800707N	Case International IHC	Baggerlader / CX	240C	60	260			47759097 KHR13590
800707N	Case International IHC	Baggerlader / CX	245D	60	260			47759097 KHR13590
800707N	Case International IHC	Baggerlader / CX	245D SR LC	60	260			47759097 KHR13590
800707N	Case International IHC	Baggerlader / CX	250C	60	260			47759097 KHR13590
800707N	Case International IHC	Baggerlader / CX	250D LC	60	260			47759097 KHR13590
800707N	Case International IHC	Baggerlader / CX	250D LC LR	60	260			47759097 KHR13590
800707N	Case International IHC	Baggerlader / CX	250D NLC	60	260			47759097 KHR13590
800707N	Case International IHC	Baggerlader / CX	260C	60	260			47759097 KHR13590
800707N	Case International IHC	Baggerlader / CX	290D LC MH	60	260			47759097 KHR13590
800707N	Case International IHC	Baggerlader / CX	290D LC SL	60	260			47759097 KHR13590

Dasis Nr.	Hersteller	Modell	Typ	Außendurchmesser [mm]	Länge [mm]	Innengewinde 1 [mm]	Außengewinde 1 [mm]	für OE-Nummer
800707N	Case International IHC	Baggerlader / CX	300B	60	260			47759097 KHR13590
800707N	Case International IHC	Baggerlader / CX	300C	60	260			47759097 KHR13590
800707N	Case International IHC	Baggerlader / CX	300D LC	60	260			47759097 KHR13590
800707N	Case International IHC	Baggerlader / CX	300D NLC	60	260			47759097 KHR13590
800707N	Case International IHC	Baggerlader / CX	330	60	260			47759097 KHR13590
800707N	Case International IHC	Baggerlader / CX	350B	60	260			47759097 KHR13590
800707N	Case International IHC	Baggerlader / CX	350C	60	260			47759097 KHR13590
800707N	Case International IHC	Baggerlader / CX	360B	60	260			47759097 KHR13590
800707N	Case International IHC	Baggerlader / CX	370B	60	260			47759097 KHR13590
800707N	Case International IHC	Baggerlader / CX	370C	60	260			47759097 KHR13590
800707N	Case International IHC	Baggerlader / CX	370D LC	60	260			47759097 KHR13590
800707N	Case International IHC	Baggerlader / CX	370D NLC	60	260			47759097 KHR13590
800707N	Case International IHC	Baggerlader / CX	380C	60	260			47759097 KHR13590
800707N	Case International IHC	Baggerlader / CX	470B	60	260			47759097 KHR13590
800707N	Case International IHC	Baggerlader / CX	470C	60	260			47759097 KHR13590
800707N	Case International IHC	Baggerlader / CX	490C	60	260			47759097 KHR13590
800707N	Case International IHC	Baggerlader / CX	490D LC	60	260			47759097 KHR13590
800707N	Case International IHC	Baggerlader / CX	490D RTC	60	260			47759097 KHR13590
800707N	Case International IHC	Baggerlader / CX	500C	60	260			47759097 KHR13590
800707N	Case International IHC	Baggerlader / CX	700B	60	260			47759097 KHR13590
800707N	Case International IHC	Baggerlader / CX	750D RTC	60	260			47759097 KHR13590
800707N	Case International IHC	Baggerlader / CX	750D RTC ME	60	260			47759097 KHR13590
800707N	Case International IHC	Baggerlader / CX	800	60	260			47759097 KHR13590
800707N	Case International IHC	Baggerlader / CX	800B	60	260			47759097 KHR13590
800377N	Case International IHC	Feldhäcksler / CHX	320	76		14	10	
800377N	Case International IHC	Feldhäcksler / CHX	420	76		14	10	
800377N	Case International IHC	Feldhäcksler / CHX	520	76		14	10	
800056N	Case International IHC	Feldhäcksler / CHX	620	102			21	
800173N	Case International IHC	Feldhäcksler / Mammüt	6900	102			10	
800173N	Case International IHC	Feldhäcksler / Mammüt	7400	102			10	
800173N	Case International IHC	Feldhäcksler / Mammüt	7800	102			10	

Dasis Nr.	Hersteller	Modell	Typ	Außendurchmesser [mm]	Länge [mm]	Innengewinde 1 [mm]	Außengewinde 1 [mm]	für OE-Nummer
800173N	Case International IHC	Feldhäcksler / Mammut	8790	102			10	
800018N	Case International IHC	Mähdrescher / 14	1420	102		14	16	
800018N	Case International IHC	Mähdrescher / 14	1440	102		14	16	
800054N	Case International IHC	Mähdrescher / 14	1460	102			15	
800018N	Case International IHC	Mähdrescher / 14	1460	102		14	16	
800054N	Case International IHC	Mähdrescher / 14	1470	102			15	
800018N	Case International IHC	Mähdrescher / 14	1470	102		14	16	
800054N	Case International IHC	Mähdrescher / 14	1480	102			15	
800018N	Case International IHC	Mähdrescher / 14	1480	102		14	16	
800018N	Case International IHC	Mähdrescher / 16	1620	102		14	16	
800018N	Case International IHC	Mähdrescher / 16	1620E	102		14	16	
800018N	Case International IHC	Mähdrescher / 16	1640	102		14	16	
800018N	Case International IHC	Mähdrescher / 16	1644	102		14	16	
800018N	Case International IHC	Mähdrescher / 16	1660	102		14	16	
800018N	Case International IHC	Mähdrescher / 16	1660E	102		14	16	
800018N	Case International IHC	Mähdrescher / 16	1666	102		14	16	
800018N	Case International IHC	Mähdrescher / 16	1670	102		14	16	
800018N	Case International IHC	Mähdrescher / 16	1680	102		14	16	
800018N	Case International IHC	Mähdrescher / 16	1680E	102		14	16	
800018N	Case International IHC	Mähdrescher / 16	1688	102		14	16	
800018N	Case International IHC	Mähdrescher / 21	2144	102		14	16	
800018N	Case International IHC	Mähdrescher / 21	2166	102		14	16	
800018N	Case International IHC	Mähdrescher / 21	2188	102		14	16	
800018N	Case International IHC	Mähdrescher / 23	2344	102		14	16	
800018N	Case International IHC	Mähdrescher / 23	2365	102		14	16	
800018N	Case International IHC	Mähdrescher / 23	2366	102		14	16	
800018N	Case International IHC	Mähdrescher / 23	2388	102		14	16	
800056N	Case International IHC	Mähdrescher / CT	5050	102			21	
800056N	Case International IHC	Mähdrescher / CT	5060	102			21	
800056N	Case International IHC	Mähdrescher / CT	5070	102			21	
800056N	Case International IHC	Mähdrescher / CT	5080	102			21	

Dasis Nr.	Hersteller	Modell	Typ	Außendurchmesser [mm]	Länge [mm]	Innengewinde 1 [mm]	Außengewinde 1 [mm]	für OE-Nummer
800546N	Case International IHC	Mähdrescher / F	F60	76			10	
800546N	Case International IHC	Mähdrescher / F	F70	76			10	
800546N	Case International IHC	Mähdrescher / F	F80	76			10	
800152N	Case International IHC	Mähdrescher 521-1150	521	80			15	
800152N	Case International IHC	Mähdrescher 521-1150	525	80			15	
800152N	Case International IHC	Mähdrescher 521-1150	527	80			15	
800018N	Case International IHC	Mähdrescher 521-1150	570L2	102		14	16	
800054N	Case International IHC	Mähdrescher 521-1150	715	102			15	
800054N	Case International IHC	Mähdrescher 521-1150	815	102			15	
800018N	Case International IHC	Mähdrescher 521-1150	821	102		14	16	
800054N	Case International IHC	Mähdrescher 521-1150	915	102			15	
800018N	Case International IHC	Mähdrescher 521-1150	1150H	102		14	16	
800018N	Case International IHC	Raupen Dozer	780	102		14	16	
800018N	Case International IHC	Raupen Dozer	850E	102		14	16	
800018N	Case International IHC	Raupen Dozer	850G	102		14	16	
800018N	Case International IHC	Raupen Dozer	850H	102		14	16	
800018N	Case International IHC	Raupen Dozer	850K	102		14	16	
800015N	Case International IHC	Schaufellader	521	102				
800018N	Case International IHC	Schaufellader	570L2	102		14	16	
800015N	Case International IHC	Schaufellader	621	102				
800015N	Case International IHC	Schaufellader	721	102				
800018N	Case International IHC	Schaufellader	821	102		14	16	
800018N	Case International IHC	Schaufellader	921	102		14	16	
800018N	Case International IHC	Schaufellader	1150H	102		14	16	
801720N	Case International IHC	Schaufellader	W14					
801720N	Case International IHC	Schaufellader	W14B					
801720N	Case International IHC	Schaufellader	W14C					
801720N	Case International IHC	Schaufellader	W18					
801720N	Case International IHC	Schaufellader	W20					
801720N	Case International IHC	Schaufellader	W20C					
801720N	Case International IHC	Schaufellader	W30					



Dasis Nr.	Hersteller	Modell	Typ	Außendurchmesser [mm]	Länge [mm]	Innengewinde 1 [mm]	Außengewinde 1 [mm]	für OE-Nummer
800054N	Case International IHC	Schlepper / 186-996	186	102			15	
800067N	Case International IHC	Schlepper / 186-996	385	102				
800067N	Case International IHC	Schlepper / 186-996	395	102				
800067N	Case International IHC	Schlepper / 186-996	485	102				
800067N	Case International IHC	Schlepper / 186-996	495	102				
800067N	Case International IHC	Schlepper / 186-996	585	102				
800067N	Case International IHC	Schlepper / 186-996	595	102				
800067N	Case International IHC	Schlepper / 186-996	685	102				
800067N	Case International IHC	Schlepper / 186-996	695	102				
800067N	Case International IHC	Schlepper / 186-996	785	102				
800067N	Case International IHC	Schlepper / 186-996	795	102				
800066N	Case International IHC	Schlepper / 186-996	856	102			16	
800067N	Case International IHC	Schlepper / 186-996	885	102				
800054N	Case International IHC	Schlepper / 186-996	886	102			15	
800067N	Case International IHC	Schlepper / 186-996	895	102				
800066N	Case International IHC	Schlepper / 186-996	955	102			16	
800066N	Case International IHC	Schlepper / 186-996	956	102			16	
800067N	Case International IHC	Schlepper / 186-996	985	102				
800054N	Case International IHC	Schlepper / 186-996	986	102			15	
800067N	Case International IHC	Schlepper / 186-996	995	102				
800066N	Case International IHC	Schlepper / 1046-1896	1055	102			16	
800066N	Case International IHC	Schlepper / 1046-1896	1056	102			16	
800054N	Case International IHC	Schlepper / 1046-1896	1086	102			15	
800066N	Case International IHC	Schlepper / 1046-1896	1255	102			16	
800066N	Case International IHC	Schlepper / 1046-1896	1455	102			16	
800054N	Case International IHC	Schlepper / 1046-1896	1486	102			15	
800054N	Case International IHC	Schlepper / 1046-1896	1586	102			15	
800543N	Case International IHC	Schlepper / 1046-1896	1896	70			10	
800543N	Case International IHC	Schlepper / 2096-2388	2096	70			10	
800018N	Case International IHC	Schlepper / 3088-3788	3088	102		14	16	
800018N	Case International IHC	Schlepper / 3088-3788	3210	102		14	16	

Dasis Nr.	Hersteller	Modell	Typ	Außendurchmesser [mm]	Länge [mm]	Innengewinde 1 [mm]	Außengewinde 1 [mm]	für OE-Nummer
800018N	Case International IHC	Schlepper / 3088-3788	3220	102		14	16	
800018N	Case International IHC	Schlepper / 3088-3788	3230	102		14	16	
800018N	Case International IHC	Schlepper / 3088-3788	3288	102		14	16	
800018N	Case International IHC	Schlepper / 3088-3788	3388	102		14	16	
800018N	Case International IHC	Schlepper / 3088-3788	3488	102		14	16	
800018N	Case International IHC	Schlepper / 3088-3788	3588	102		14	16	
800018N	Case International IHC	Schlepper / 3088-3788	3688	102		14	16	
800018N	Case International IHC	Schlepper / 3088-3788	3788	102		14	16	
800067N	Case International IHC	Schlepper / 4000-4894	4210	102				
800067N	Case International IHC	Schlepper / 4000-4894	4220	102				
800067N	Case International IHC	Schlepper / 4000-4894	4230	102				
800067N	Case International IHC	Schlepper / 4000-4894	4240	102				
800543N	Case International IHC	Schlepper / 4000-4894	4490	70			10	
800543N	Case International IHC	Schlepper / 4000-4894	4494	70			10	
800543N	Case International IHC	Schlepper / 4000-4894	4690	70			10	
800543N	Case International IHC	Schlepper / 4000-4894	4694	70			10	
800543N	Case International IHC	Schlepper / 4000-4894	4890	70			10	
800543N	Case International IHC	Schlepper / 4000-4894	4894	70			10	
800018N	Case International IHC	Schlepper / 5088-5488	5088	102		14	16	
800018N	Case International IHC	Schlepper / 5088-5488	5120	102		14	16	
800018N	Case International IHC	Schlepper / 5088-5488	5130	102		14	16	
800018N	Case International IHC	Schlepper / 5088-5488	5140	102		14	16	
800018N	Case International IHC	Schlepper / 5088-5488	5150	102		14	16	
800018N	Case International IHC	Schlepper / 5088-5488	5220	102		14	16	
800018N	Case International IHC	Schlepper / 5088-5488	5230	102		14	16	
800018N	Case International IHC	Schlepper / 5088-5488	5240	102		14	16	
800018N	Case International IHC	Schlepper / 5088-5488	5250	102		14	16	
800018N	Case International IHC	Schlepper / 5088-5488	5288	102		14	16	
800018N	Case International IHC	Schlepper / 5088-5488	5488	102		14	16	
800018N	Case International IHC	Schlepper / 6388-6788	6388	102		14	16	
800018N	Case International IHC	Schlepper / 6388-6788	6588	102		14	16	

Dasis Nr.	Hersteller	Modell	Typ	Außendurchmesser [mm]	Länge [mm]	Innengewinde 1 [mm]	Außengewinde 1 [mm]	für OE-Nummer
800018N	Case International IHC	Schlepper / 6388-6788	6788	102		14	16	
800018N	Case International IHC	Schlepper / 7110-7488	7110	102		14	16	
800018N	Case International IHC	Schlepper / 7110-7488	7110E	102		14	16	
800018N	Case International IHC	Schlepper / 7110-7488	7120	102		14	16	
800018N	Case International IHC	Schlepper / 7110-7488	7120E	102		14	16	
800018N	Case International IHC	Schlepper / 7110-7488	7130	102		14	16	
800018N	Case International IHC	Schlepper / 7110-7488	7140	102		14	16	
800018N	Case International IHC	Schlepper / 7110-7488	7150	102		14	16	
800018N	Case International IHC	Schlepper / 7110-7488	7210	102		14	16	
800018N	Case International IHC	Schlepper / 7110-7488	7220	102		14	16	
800018N	Case International IHC	Schlepper / 7110-7488	7230	102		14	16	
800018N	Case International IHC	Schlepper / 7110-7488	7240	102		14	16	
800018N	Case International IHC	Schlepper / 7110-7488	7250	102		14	16	
800018N	Case International IHC	Schlepper / 7110-7488	7288	102		14	16	
800018N	Case International IHC	Schlepper / 7110-7488	7488	102		14	16	
800018N	Case International IHC	Schlepper / 8910-8950	8910	102		14	16	
800018N	Case International IHC	Schlepper / 8910-8950	8920	102		14	16	
800018N	Case International IHC	Schlepper / 8910-8950	8930	102		14	16	
800018N	Case International IHC	Schlepper / 8910-8950	8940	102		14	16	
800018N	Case International IHC	Schlepper / 8910-8950	8950	102		14	16	
800383N	Case International IHC	Schlepper / 9110-9390	9110	76				
800383N	Case International IHC	Schlepper / 9110-9390	9130	76				
800383N	Case International IHC	Schlepper / 9110-9390	9150	76				
800383N	Case International IHC	Schlepper / 9110-9390	9170	76				
800383N	Case International IHC	Schlepper / 9110-9390	9180	76				
800677N	Case International IHC	Schlepper / C	85	10				47465067 47465072
800677N	Case International IHC	Schlepper / C	95	10				47465067 47465072
800677N	Case International IHC	Schlepper / C	105	10				47465067 47465072
800049N	Case International IHC	Schlepper / CS	68	76			16	
800049N	Case International IHC	Schlepper / CS	75	76			16	
800064N	Case International IHC	Schlepper / CS	75	76			16	

Dasis Nr.	Hersteller	Modell	Typ	Außendurchmesser [mm]	Länge [mm]	Innengewinde 1 [mm]	Außengewinde 1 [mm]	für OE-Nummer
800056N	Case International IHC	Schlepper / CS	75	102			21	
800049N	Case International IHC	Schlepper / CS	78	76			16	
800064N	Case International IHC	Schlepper / CS	78	76			16	
800056N	Case International IHC	Schlepper / CS	78	102			21	
800049N	Case International IHC	Schlepper / CS	80	76			16	
800064N	Case International IHC	Schlepper / CS	86	76			16	
800049N	Case International IHC	Schlepper / CS	86	76			16	
800056N	Case International IHC	Schlepper / CS	86	102			21	
800064N	Case International IHC	Schlepper / CS	94	76			16	
800049N	Case International IHC	Schlepper / CS	94	76			16	
800056N	Case International IHC	Schlepper / CS	94	102			21	
800049N	Case International IHC	Schlepper / CS	100	76			16	
800064N	Case International IHC	Schlepper / CS	100	76			16	
800064N	Case International IHC	Schlepper / CS	110	76			16	
800064N	Case International IHC	Schlepper / CS	120	76			16	
800064N	Case International IHC	Schlepper / CS	130	76			16	
800064N	Case International IHC	Schlepper / CS	150	76			16	
800018N	Case International IHC	Schlepper / CX	50	102		14	16	
800018N	Case International IHC	Schlepper / CX	60	102		14	16	
800018N	Case International IHC	Schlepper / CX	70	102		14	16	
800018N	Case International IHC	Schlepper / CX	80	102		14	16	
800018N	Case International IHC	Schlepper / CX	90	102		14	16	
800018N	Case International IHC	Schlepper / CX	100	102		14	16	
800679N	Case International IHC	Schlepper / Farmall A Serie	85a					47530212
800679N	Case International IHC	Schlepper / Farmall A Serie	95A					47530212
800679N	Case International IHC	Schlepper / Farmall A Serie	105A					47530212
800679N	Case International IHC	Schlepper / Farmall A Serie	115A					47530212
800679N	Case International IHC	Schlepper / Farmall C Serie	55C					47530212
800679N	Case International IHC	Schlepper / Farmall C Serie	65C					47530212
800679N	Case International IHC	Schlepper / Farmall C Serie	75C					47530212
800677N	Case International IHC	Schlepper / Farmall U Serie	95U	10				47465067 47465072

Dasis Nr.	Hersteller	Modell	Typ	Außendurchmesser [mm]	Länge [mm]	Innengewinde 1 [mm]	Außengewinde 1 [mm]	für OE-Nummer
800677N	Case International IHC	Schlepper / Farmall U Serie	105U	10				47465067 47465072
800677N	Case International IHC	Schlepper / Farmall U Serie	110U	10				47465067 47465072
800677N	Case International IHC	Schlepper / Farmall U Serie	115U	10				47465067 47465072
800677N	Case International IHC	Schlepper / Farmall U Serie	120U	10				47465067 47465072
800386N	Case International IHC	Schlepper / FLX	3300B	76				
800154N	Case International IHC	Schlepper / JX	55	62				
800154N	Case International IHC	Schlepper / JX	60	62				
800154N	Case International IHC	Schlepper / JX	65	62				
800154N	Case International IHC	Schlepper / JX	70	62				
800154N	Case International IHC	Schlepper / JX	75	62				
800154N	Case International IHC	Schlepper / JX	80	62				
800154N	Case International IHC	Schlepper / JX	85	62				
800154N	Case International IHC	Schlepper / JX	90	62				
800154N	Case International IHC	Schlepper / JX	95	62				
800154N	Case International IHC	Schlepper / JX	1060	62				
800154N	Case International IHC	Schlepper / JX	1070	62				
800154N	Case International IHC	Schlepper / JX	1075	62				
800154N	Case International IHC	Schlepper / JXU	1070U	62				
800154N	Case International IHC	Schlepper / JXU	1080U	62				
800154N	Case International IHC	Schlepper / JXU	1090U	62				
800154N	Case International IHC	Schlepper / JXU	1100U	62				
800067N	Case International IHC	Schlepper / Kabine Deluxe	KabineDeluxe	102				
800677N	Case International IHC	Schlepper / Luxum	100	10				47465067 47465072
800677N	Case International IHC	Schlepper / Luxum	110	10				47465067 47465072
800677N	Case International IHC	Schlepper / Luxum	120	10				47465067 47465072
800018N	Case International IHC	Schlepper / MX	100	102		14	16	
800018N	Case International IHC	Schlepper / MX	110	102		14	16	
800018N	Case International IHC	Schlepper / MX	120	102		14	16	
800018N	Case International IHC	Schlepper / MX	135	102		14	16	
800018N	Case International IHC	Schlepper / MX	150	102		14	16	
800018N	Case International IHC	Schlepper / MX	170	102		14	16	

Dasis Nr.	Hersteller	Modell	Typ	Außendurchmesser [mm]	Länge [mm]	Innengewinde 1 [mm]	Außengewinde 1 [mm]	für OE-Nummer
800018N	Case International IHC	Schlepper / MX	180	102		14	16	
800018N	Case International IHC	Schlepper / MX	200	102		14	16	
800018N	Case International IHC	Schlepper / MX	210	102		14	16	
800018N	Case International IHC	Schlepper / MX	220	102		14	16	
800018N	Case International IHC	Schlepper / MX	230	102		14	16	
800018N	Case International IHC	Schlepper / MX	240	102		14	16	
800018N	Case International IHC	Schlepper / MX	255	102		14	16	
800018N	Case International IHC	Schlepper / MX	270	102		14	16	
800018N	Case International IHC	Schlepper / MX	285	102		14	16	
800018N	Case International IHC	Schlepper / MXC	80	102		14	16	
800018N	Case International IHC	Schlepper / MXC	90	102		14	16	
800018N	Case International IHC	Schlepper / MXC	100	102		14	16	
800279N	Case International IHC	Schlepper / MXM	120	63,5		20	20	
800279N	Case International IHC	Schlepper / MXM	130	63,5		20	20	
800279N	Case International IHC	Schlepper / MXM	135	63,5		20	20	
800279N	Case International IHC	Schlepper / MXM	140	63,5		20	20	
800279N	Case International IHC	Schlepper / MXM	150	63,5		20	20	
800279N	Case International IHC	Schlepper / MXM	155	63,5		20	20	
800279N	Case International IHC	Schlepper / MXM	165	63,5		20	20	
800279N	Case International IHC	Schlepper / MXM	175	63,5		20	20	
800279N	Case International IHC	Schlepper / MXM	180	63,5		20	20	
800279N	Case International IHC	Schlepper / MXM	190	63,5		20	20	
800279N	Case International IHC	Schlepper / MXU	100	63,5		20	20	
800279N	Case International IHC	Schlepper / MXU	110	63,5		20	20	
800279N	Case International IHC	Schlepper / MXU	115	63,5		20	20	
800279N	Case International IHC	Schlepper / MXU	125	63,5		20	20	
800279N	Case International IHC	Schlepper / MXU	135	63,5		20	20	
800064N	Case International IHC	Schlepper / PJV Hydro	100	76			16	
800064N	Case International IHC	Schlepper / PJV Hydro	186	76			16	
800018N	Case International IHC	Schlepper / Quadtrac	Quadtrac	102		14	16	
800539N	Caterpillar	Bagger 360 Grad / 200	215	102				

Dasis Nr.	Hersteller	Modell	Typ	Außendurchmesser [mm]	Länge [mm]	Innengewinde 1 [mm]	Außengewinde 1 [mm]	für OE-Nummer
800056N	Caterpillar	Bagger 360 Grad / 200	215	102			21	
800056N	Caterpillar	Bagger 360 Grad / 200	225	102			21	
800539N	Caterpillar	Bagger 360 Grad / 200	235	102				
800056N	Caterpillar	Bagger 360 Grad / 200	235	102			21	
800539N	Caterpillar	Bagger 360 Grad / 200	245	102				
800056N	Caterpillar	Bagger 360 Grad / 200	245	102			21	
800056N	Caterpillar	Bagger 360 Grad / 200D	245	102			21	
800556N	Caterpillar	Bagger 360 Grad / 300B	320					
802780N	Caterpillar	Bagger 360 Grad / 300BL	345	63,5				
800393N	Caterpillar	Bagger 360 Grad / 300CL	325	61		10		
800393N	Caterpillar	Bagger 360 Grad / 300CL	330	61		10		
800393N	Caterpillar	Bagger 360 Grad / 300CL	345	61		10		
800393N	Caterpillar	Bagger 360 Grad / 300CL	365	61		10		
800393N	Caterpillar	Bagger 360 Grad / 300CL	385	61		10		
800967N	Caterpillar	Bagger 360 Grad / 300 Serie	304CR					1251642 CA1251642
800967N	Caterpillar	Bagger 360 Grad / 300 Serie	305.5					1251642 CA1251642
800967N	Caterpillar	Bagger 360 Grad / 300 Serie	305CR					1251642 CA1251642
800967N	Caterpillar	Bagger 360 Grad / 300 Serie	306					1251642 CA1251642
800967N	Caterpillar	Bagger 360 Grad / 300 Serie	306E					1251642 CA1251642
800967N	Caterpillar	Bagger 360 Grad / 300 Serie	313B CR					1251642 CA1251642
800966N	Caterpillar	Bagger 360 Grad / 300 Serie	320E	60		9		
800966N	Caterpillar	Bagger 360 Grad / 300 Serie	320E L	60		9		
800966N	Caterpillar	Bagger 360 Grad / 300 Serie	320E LN	60		9		
800966N	Caterpillar	Bagger 360 Grad / 300 Serie	320E LRR	60		9		
800966N	Caterpillar	Bagger 360 Grad / 300 Serie	320E RR	60		9		
800966N	Caterpillar	Bagger 360 Grad / 300 Serie	323E L	60		9		
800966N	Caterpillar	Bagger 360 Grad / 300 Serie	323E LN	60		9		
800966N	Caterpillar	Bagger 360 Grad / 300 Serie	323E SA	60		9		
800966N	Caterpillar	Bagger 360 Grad / 300 Serie	324E	60		9		
800966N	Caterpillar	Bagger 360 Grad / 300 Serie	324E L	60		9		
800966N	Caterpillar	Bagger 360 Grad / 300 Serie	324E LN	60		9		

Dasis Nr.	Hersteller	Modell	Typ	Außendurchmesser [mm]	Länge [mm]	Innengewinde 1 [mm]	Außengewinde 1 [mm]	für OE-Nummer
800966N	Caterpillar	Bagger 360 Grad / 300 Serie	329F	60		9		
800966N	Caterpillar	Bagger 360 Grad / 300 Serie	336E	60		9		
800966N	Caterpillar	Bagger 360 Grad / 300 Serie	374F L	60		9		
800056N	Caterpillar	Baggerlader / 400	416	102			21	
803972N	Caterpillar	Baggerlader / 400	416B	76			16	
803972N	Caterpillar	Baggerlader / 400	426B	76			16	
800536N	Caterpillar	Baggerlader / 400	436	89		9		
800536N	Caterpillar	Baggerlader / 400	438	89		9		
800056N	Caterpillar	Baggerlader / 400B	416	102			21	
800536N	Caterpillar	Baggerlader / 400C	436	89		9		
800536N	Caterpillar	Baggerlader / 400C	438	89		9		
800965N	Caterpillar	Hydraulikbagger / 6000 Serie	6015B	76		11		3551793
800548N	Caterpillar	Kniegelenke Truck / 3/5C	315	76			10	
802780N	Caterpillar	Kniegelenke Truck / 700	725	63,5				
800536N	Caterpillar	Kniegelenke Truck / 700	725	89		9		
802780N	Caterpillar	Kniegelenke Truck / 700	730	63,5				
800536N	Caterpillar	Kniegelenke Truck / 700	730	89		9		
802780N	Caterpillar	Kniegelenke Truck / 700	735	63,5				
800536N	Caterpillar	Kniegelenke Truck / 700	735	89		9		
802780N	Caterpillar	Kniegelenke Truck / 700	740	63,5				
800536N	Caterpillar	Kniegelenke Truck / 700	740	89		9		
800538N	Caterpillar	Kniegelenke Truck / D	25	102				
800538N	Caterpillar	Kniegelenke Truck / D	30	102				
800538N	Caterpillar	Kniegelenke Truck / D	40	102				
800538N	Caterpillar	Kniegelenke Truck / D	250	102				
800056N	Caterpillar	Kniegelenke Truck / D	300	102			21	
800538N	Caterpillar	Kniegelenke Truck / D	350	102				
800051N	Caterpillar	Minibagger / Landfill	815					
800051N	Caterpillar	Minibagger / Landfill	816					
800051N	Caterpillar	Minibagger / Landfill	826B					
800051N	Caterpillar	Minibagger / Landfill	834					



Dasis Nr.	Hersteller	Modell	Typ	Außendurchmesser [mm]	Länge [mm]	Innengewinde 1 [mm]	Außengewinde 1 [mm]	für OE-Nummer
800051N	Caterpillar	Minibagger / Landfill	835					
803972N	Caterpillar	Motorgrader / G	14G	76			16	
800557N	Caterpillar	Motorgrader / H	12	89				
802780N	Caterpillar	Motorgrader / H	14	63,5				
802780N	Caterpillar	Motorgrader / H	16	63,5				
802780N	Caterpillar	Motorgrader / H	120	63,5				
800557N	Caterpillar	Motorgrader / H	120	89				
802780N	Caterpillar	Motorgrader / H	135	63,5				
802780N	Caterpillar	Motorgrader / H	140	63,5				
800557N	Caterpillar	Motorgrader / H	140	89				
802780N	Caterpillar	Motorgrader / H	143	63,5				
800557N	Caterpillar	Motorgrader / H	143	89				
802780N	Caterpillar	Motorgrader / H	163	63,5				
802780N	Caterpillar	Muldenkipper / 700	769	63,5				
800536N	Caterpillar	Muldenkipper / 700	769	89		9		
802780N	Caterpillar	Muldenkipper / 700	771	63,5				
800536N	Caterpillar	Muldenkipper / 700	771	89		9		
800536N	Caterpillar	Muldenkipper / 700	775	89		9		
800538N	Caterpillar	Muldenkipper / D	400	102				
800965N	Caterpillar	Rad Dozer / 800 Serie	824K	76		11		3551793
800965N	Caterpillar	Rad Dozer / 800 Serie	825K	76		11		3551793
800965N	Caterpillar	Rad Dozer / 800 Serie	826K	76		11		3551793
800965N	Caterpillar	Rad Dozer / 800 Serie	834K	76		11		3551793
800965N	Caterpillar	Rad Dozer / 800 Serie	836K	76		11		3551793
800965N	Caterpillar	Radlader / 900 Serie	950M	76		11		3551793
800965N	Caterpillar	Radlader / 900 Serie	962M	76		11		3551793
800965N	Caterpillar	Radlader / 900 Serie	966M	76		11		3551793
800965N	Caterpillar	Radlader / 900 Serie	972M	76		11		3551793
800965N	Caterpillar	Radlader / 900 Serie	980M	76		11		3551793
800965N	Caterpillar	Radlader / 900 Serie	982M	76		11		3551793
800965N	Caterpillar	Radlader / 900 Serie	988K	76		11		3551793

Dasis Nr.	Hersteller	Modell	Typ	Außendurchmesser [mm]	Länge [mm]	Innengewinde 1 [mm]	Außengewinde 1 [mm]	für OE-Nummer
802780N	Caterpillar	Raupen Dozer / 900	931	63,5				
800536N	Caterpillar	Raupen Dozer / 900	931	89		9		
802780N	Caterpillar	Raupen Dozer / 900	931B	63,5				
800536N	Caterpillar	Raupen Dozer / 900	931B	89		9		
800051N	Caterpillar	Raupen Dozer / 900	951B					
802780N	Caterpillar	Raupen Dozer / 900	955	63,5				
800536N	Caterpillar	Raupen Dozer / 900	955	89		9		
802780N	Caterpillar	Raupen Dozer / 900	963	63,5				
800536N	Caterpillar	Raupen Dozer / 900	963	89		9		
802780N	Caterpillar	Raupen Dozer / 900	973	63,5				
800056N	Caterpillar	Raupen Dozer / 900	992	102			21	
802780N	Caterpillar	Raupen Dozer / D	10R	63,5				
800536N	Caterpillar	Raupen Dozer / D	10R	89		9		
803972N	Caterpillar	Raupen Dozer / D	4	76			16	
803972N	Caterpillar	Raupen Dozer / D	4E	76			16	
803972N	Caterpillar	Raupen Dozer / D	5B	76			16	
803972N	Caterpillar	Raupen Dozer / D	5H	76			16	
800964N	Caterpillar	Raupen Dozer / D	6K	64	195			2717421
802780N	Caterpillar	Raupen Dozer / D	6R	63,5				
800536N	Caterpillar	Raupen Dozer / D	6R	89		9		
800051N	Caterpillar	Raupen Dozer / D	8					
800051N	Caterpillar	Raupen Dozer / D	8H					
802780N	Caterpillar	Raupen Dozer / D	9R	63,5				
800536N	Caterpillar	Raupen Dozer / D	9R	89		9		
800051N	Caterpillar	Raupen Dozer / D	10					
800392N	Caterpillar	Raupen Schlepper / Challenger	35	76				
800392N	Caterpillar	Raupen Schlepper / Challenger	45	76				
800392N	Caterpillar	Raupen Schlepper / Challenger	55	76				
800340N	Caterpillar	Raupen Schlepper / Challenger	65	89		25		

Dasis Nr.	Hersteller	Modell	Typ	Außendurchmesser [mm]	Länge [mm]	Innengewinde 1 [mm]	Außengewinde 1 [mm]	für OE-Nummer
800536N	Caterpillar	Raupen Schlepper / Challenger	65E	89		9		
800340N	Caterpillar	Raupen Schlepper / Challenger	75	89		25		
800536N	Caterpillar	Raupen Schlepper / Challenger	75E	89		9		
800340N	Caterpillar	Raupen Schlepper / Challenger	85	89		25		
800536N	Caterpillar	Raupen Schlepper / Challenger	85E	89		9		
800536N	Caterpillar	Raupen Schlepper / Challenger	95E	89		9		
800536N	Caterpillar	Schaufellader / 900	910G	89		9		
803972N	Caterpillar	Schaufellader / 900	916	76			16	
800538N	Caterpillar	Schaufellader / 900	918	102				
800051N	Caterpillar	Schaufellader / 900	920					
803972N	Caterpillar	Schaufellader / 900	936	76			16	
800536N	Caterpillar	Schaufellader / 900	938G	89		9		
800051N	Caterpillar	Schaufellader / 900	950					
802780N	Caterpillar	Schaufellader / 900	950G	63,5				
800536N	Caterpillar	Schaufellader / 900	950G	89		9		
802780N	Caterpillar	Schaufellader / 900	962G	63,5				
800536N	Caterpillar	Schaufellader / 900	962G	89		9		
802780N	Caterpillar	Schaufellader / 900	966G	63,5				
800536N	Caterpillar	Schaufellader / 900	966G	89		9		
802780N	Caterpillar	Schaufellader / 900	972G	63,5				
800536N	Caterpillar	Schaufellader / 900	980H	89		9		
800536N	Caterpillar	Schaufellader / 900	990H	89		9		
800536N	Caterpillar	Schaufellader / Challenger	65E	89		9		
800536N	Caterpillar	Schaufellader / Challenger	75E	89		9		
800536N	Caterpillar	Schaufellader / Challenger	85E	89		9		
800536N	Caterpillar	Schaufellader / Challenger	95E	89		9		
803972N	Caterpillar	Schürfzüge / Coal bowl	637	76			16	
803972N	Caterpillar	Schürfzüge / Coal bowl	637D	76			16	
800545N	Caterpillar	Schürfzüge / Coal bowl	637E	76				

Dasis Nr.	Hersteller	Modell	Typ	Außendurchmesser [mm]	Länge [mm]	Innengewinde 1 [mm]	Außengewinde 1 [mm]	für OE-Nummer
803972N	Caterpillar	Schürfzüge / Coal bowl	637E	76			16	
800539N	Caterpillar	Schürfzüge / Coal bowl	639	102				
803972N	Caterpillar	Schürfzüge / Elevating	613B	76			16	
803972N	Caterpillar	Schürfzüge / Elevating	613C	76			16	
803972N	Caterpillar	Schürfzüge / Elevating	615	76			16	
800557N	Caterpillar	Schürfzüge / H	163	89				
800051N	Caterpillar	Schürfzüge / Open bowl	621					
803972N	Caterpillar	Schürfzüge / Open bowl	621B	76			16	
803972N	Caterpillar	Schürfzüge / Open bowl	626	76			16	
800051N	Caterpillar	Schürfzüge / Open bowl	627					
803972N	Caterpillar	Schürfzüge / Open bowl	627B	76			16	
800539N	Caterpillar	Schürfzüge / Open bowl	627B	102				
800051N	Caterpillar	Schürfzüge / Open bowl	631					
803972N	Caterpillar	Schürfzüge / Open bowl	631	76			16	
800539N	Caterpillar	Schürfzüge / Open bowl	631	102				
803972N	Caterpillar	Schürfzüge / Open bowl	631E	76			16	
800051N	Caterpillar	Schürfzüge / Open bowl	633					
803972N	Caterpillar	Schürfzüge / Open bowl	633	76			16	
800539N	Caterpillar	Schürfzüge / Open bowl	633	102				
800051N	Caterpillar	Schürfzüge / Open bowl	637					
803972N	Caterpillar	Schürfzüge / Open bowl	637	76			16	
800539N	Caterpillar	Schürfzüge / Open bowl	637	102				
803972N	Caterpillar	Schürfzüge / Open bowl	639	76			16	
803972N	Caterpillar	Schürfzüge / Open bowl	639D	76			16	
800051N	Caterpillar	Schürfzüge / Open bowl	641B					
803972N	Caterpillar	Schürfzüge / Open bowl	641B	76			16	
800051N	Caterpillar	Schürfzüge / Open bowl	650B					
800051N	Caterpillar	Schürfzüge / Open bowl	651B					
803972N	Caterpillar	Walzenzüge / Landfill	815	76			16	
803972N	Caterpillar	Walzenzüge / Landfill	815B	76			16	
803972N	Caterpillar	Walzenzüge / Landfill	816	76			16	

Dasis Nr.	Hersteller	Modell	Typ	Außendurchmesser [mm]	Länge [mm]	Innengewinde 1 [mm]	Außengewinde 1 [mm]	für OE-Nummer
803972N	Caterpillar	Walzenzüge / Landfill	816C	76			16	
803972N	Caterpillar	Walzenzüge / Landfill	824	76			16	
803972N	Caterpillar	Walzenzüge / Landfill	824B	76			16	
803972N	Caterpillar	Walzenzüge / Landfill	825	76			16	
803972N	Caterpillar	Walzenzüge / Landfill	825C	76			16	
803972N	Caterpillar	Walzenzüge / Landfill	826B	76			16	
803972N	Caterpillar	Walzenzüge / Landfill	834	76			16	
803972N	Caterpillar	Walzenzüge / Landfill	835	76			16	
800049N	Claas	Feldhäcksler / Jaguar	685	76			16	
800176N	Claas	Feldhäcksler / Jaguar	685	76		10	16	
800049N	Claas	Feldhäcksler / Jaguar	690	76			16	
800176N	Claas	Feldhäcksler / Jaguar	690	76		10	16	
800049N	Claas	Feldhäcksler / Jaguar	695	76			16	
800176N	Claas	Feldhäcksler / Jaguar	695	76		10	16	
800173N	Claas	Feldhäcksler / Jaguar	860	102			10	
800173N	Claas	Feldhäcksler / Jaguar	880	102			10	
800176N	Claas	Feldhäcksler / Mega	202	76		10	16	
800176N	Claas	Feldhäcksler / Mega	203	76		10	16	
800176N	Claas	Feldhäcksler / Mega	204	76		10	16	
800176N	Claas	Feldhäcksler / Mega	208	76		10	16	
800176N	Claas	Feldhäcksler / Mega	218	76		10	16	
800536N	Claas	Mähdrescher / Challenger	65	89		9		
800536N	Claas	Mähdrescher / Challenger	75	89		9		
800536N	Claas	Mähdrescher / Challenger	85	89		9		
800536N	Claas	Mähdrescher / Challenger	95E	89		9		
800055N	Claas	Mähdrescher / Dominator 6	56	76			15,6	
800055N	Claas	Mähdrescher / Dominator 6	66	76			15,6	
800055N	Claas	Mähdrescher / Dominator 6	76	76			15,6	
800055N	Claas	Mähdrescher / Dominator 6	86	76			15,6	
800055N	Claas	Mähdrescher / Dominator 6	96	76			15,6	
800055N	Claas	Mähdrescher / Dominator 6	106	76			15,6	

Dasis Nr.	Hersteller	Modell	Typ	Außendurchmesser [mm]	Länge [mm]	Innengewinde 1 [mm]	Außengewinde 1 [mm]	für OE-Nummer
800055N	Claas	Mähdrescher / Dominator 6	116	76			15,6	
800176N	Claas	Mähdrescher / Dominator 8	98	76		10	16	
800541N	Claas	Mähdrescher / Dominator S	76S	76			10	
800541N	Claas	Mähdrescher / Dominator S	78S	76			10	
800541N	Claas	Mähdrescher / Dominator S	106S	76			10	
800541N	Claas	Mähdrescher / Dominator S	106SL	76			10	
800541N	Claas	Mähdrescher / Dominator S	108S	76			10	
800541N	Claas	Mähdrescher / Dominator S	108SL	76			10	
800541N	Claas	Mähdrescher / Dominator S	116	76			10	
800541N	Claas	Mähdrescher / Lexion	410	76			10	
800176N	Claas	Mähdrescher / Lexion	410	76		10	16	
800541N	Claas	Mähdrescher / Lexion	420	76			10	
800176N	Claas	Mähdrescher / Lexion	420	76		10	16	
800541N	Claas	Mähdrescher / Lexion	430	76			10	
800176N	Claas	Mähdrescher / Lexion	430	76		10	16	
800541N	Claas	Mähdrescher / Lexion	450	76			10	
800176N	Claas	Mähdrescher / Lexion	450	76		10	16	
800541N	Claas	Mähdrescher / Lexion	460	76			10	
800176N	Claas	Mähdrescher / Lexion	460	76		10	16	
800541N	Claas	Mähdrescher / Lexion	480	76			10	
800176N	Claas	Mähdrescher / Lexion	480	76		10	16	
800176N	Claas	Mähdrescher / Mega	202	76		10	16	
800176N	Claas	Mähdrescher / Mega	203	76		10	16	
800176N	Claas	Mähdrescher / Mega	204	76		10	16	
800176N	Claas	Mähdrescher / Mega	208	76		10	16	
800176N	Claas	Mähdrescher / Mega	218	76		10	16	
800204N	Claas	Raupen Dozer / Challenger	35	76				
800204N	Claas	Raupen Dozer / Challenger	45	76				
800204N	Claas	Raupen Dozer / Challenger	55	76				
800155N	Claas	Schlepper / Ares 500	547	76			16	
800155N	Claas	Schlepper / Ares 500	557	76			16	

Dasis Nr.	Hersteller	Modell	Typ	Außendurchmesser [mm]	Länge [mm]	Innengewinde 1 [mm]	Außengewinde 1 [mm]	für OE-Nummer
800155N	Claas	Schlepper / Ares 500	567	76			16	
800155N	Claas	Schlepper / Ares 500	577	76			16	
800155N	Claas	Schlepper / Ares 600	617	76			16	
800155N	Claas	Schlepper / Ares 600	657	76			16	
800155N	Claas	Schlepper / Ares 600	697	76			16	
800155N	Claas	Schlepper / Ares 800	816	76			16	
800155N	Claas	Schlepper / Ares 800	826	76			16	
800155N	Claas	Schlepper / Ares 800	836	76			16	
800155N	Claas	Schlepper / Celtis	426	76			16	
800155N	Claas	Schlepper / Celtis	436	76			16	
800155N	Claas	Schlepper / Celtis	446	76			16	
800155N	Claas	Schlepper / Celtis	456	76			16	
800541N	Claas	Schmädmäher / Jaguar Profistar	830	76			10	
800541N	Claas	Schmädmäher / Jaguar Profistar	850	76			10	
800541N	Claas	Schmädmäher / Jaguar Profistar	870	76			10	
800541N	Claas	Schmädmäher / Jaguar Profistar	890	76			10	
800541N	Claas	Schmädmäher / Jaguar Profistar	900	76			10	
800163N	Claas	Targo	40	102		10	15	
800163N	Claas	Targo	50	102		10	15	
800163N	Claas	Targo	K50	102		10	15	
800163N	Claas	Targo	K60	102		10	15	
800163N	Claas	Targo	K70	102		10	15	
800045N	Claas	Teleskoplader / Ranger	920	60			15	
800045N	Claas	Teleskoplader / Ranger	925	60			15	
800045N	Claas	Teleskoplader / Ranger	928	60			15	
800045N	Claas	Teleskoplader / Ranger	964	60			15	
800045N	Claas	Teleskoplader / Ranger	965	60			15	
800045N	Claas	Teleskoplader / Ranger	974	60			15	
800045N	Claas	Teleskoplader / Ranger	975	60			15	

Dasis Nr.	Hersteller	Modell	Typ	Außendurchmesser [mm]	Länge [mm]	Innengewinde 1 [mm]	Außengewinde 1 [mm]	für OE-Nummer
800015N	Deutz	Schlepper / 8000	8500	102				
800015N	Deutz	Schlepper / 8000	8600	102				
800056N	Deutz	Schlepper / 9000	9700	102			21	
800015N	Deutz	Schlepper / 9000	9800	102				
800010N	Deutz	Schlepper / Agroplus mk1	60	76		14,7	15,8	
800010N	Deutz	Schlepper / Agroplus mk1	70	76		14,7	15,8	
800010N	Deutz	Schlepper / Agroplus mk1	80	76		14,7	15,8	
800010N	Deutz	Schlepper / Agroplus mk2	75	76		14,7	15,8	
800010N	Deutz	Schlepper / Agroplus mk2	85	76		14,7	15,8	
800010N	Deutz	Schlepper / Agroplus mk2	95	76		14,7	15,8	
800010N	Deutz	Schlepper / Agroplus mk2	100	76		14,7	15,8	
800201N	Deutz	Schlepper / AgroPrima DX	4.31	76			10	
800201N	Deutz	Schlepper / AgroPrima DX	4.51	76			10	
800201N	Deutz	Schlepper / AgroPrima DX	4.56	76			10	
800201N	Deutz	Schlepper / AgroPrima DX	6.06	76			10	
800201N	Deutz	Schlepper / AgroPrima DX	6.16	76			10	
800201N	Deutz	Schlepper / AgroStar	4.61	76			10	
800201N	Deutz	Schlepper / AgroStar	4.71	76			10	
800201N	Deutz	Schlepper / AgroStar	6.11	76			10	
800201N	Deutz	Schlepper / AgroStar	6.21	76			10	
800201N	Deutz	Schlepper / AgroStar	6.31	76			10	
800201N	Deutz	Schlepper / AgroStar	6.61	76			10	
800433N	Deutz	Schlepper / AgroStar	8360	70				
800433N	Deutz	Schlepper / AgroStar	8425	70				
800201N	Deutz	Schlepper / AgroStar Freisicht S.	4.68	76			10	
800201N	Deutz	Schlepper / AgroStar Freisicht S.	4.78	76			10	
800201N	Deutz	Schlepper / AgroStar Freisicht S.	6.08	76			10	
800201N	Deutz	Schlepper / AgroStar Freisicht S.	6.28	76			10	
800201N	Deutz	Schlepper / AgroStar Freisicht S.	6.38	76			10	



Dasis Nr.	Hersteller	Modell	Typ	Außendurchmesser [mm]	Länge [mm]	Innengewinde 1 [mm]	Außengewinde 1 [mm]	für OE-Nummer
800201N	Deutz	Schlepper / AgroStar TG	6.71	76			10	
800201N	Deutz	Schlepper / AgroStar TG	6.81	76			10	
800708N	Deutz	Schlepper / Agrottron	6120.4	40	297			001908094
800708N	Deutz	Schlepper / Agrottron	6120.4 P	40	297			001908094
800708N	Deutz	Schlepper / Agrottron	6130.4	40	297			001908094
800708N	Deutz	Schlepper / Agrottron	6130.4 P	40	297			001908094
800708N	Deutz	Schlepper / Agrottron	6140	40	297			001908094
800708N	Deutz	Schlepper / Agrottron	6140.4	40	297			001908094
800708N	Deutz	Schlepper / Agrottron	6140.4 P	40	297			001908094
800708N	Deutz	Schlepper / Agrottron	6140 P	40	297			001908094
800118N	Deutz	Schlepper / Agrottron	6150	45	298	11		0.019.0794.4/10 00190794.410 01AAC005501 1907944
800708N	Deutz	Schlepper / Agrottron	6150.4	40	297			001908094
800708N	Deutz	Schlepper / Agrottron	6150.4 P	40	297			001908094
800118N	Deutz	Schlepper / Agrottron	6150P	45	298	11		0.019.0794.4/10 00190794.410 01AAC005501 1907944
800708N	Deutz	Schlepper / Agrottron	6160.4	40	297			001908094
800708N	Deutz	Schlepper / Agrottron	6160.4 P	40	297			001908094
800118N	Deutz	Schlepper / Agrottron	6160P	45	298	11		0.019.0794.4/10 00190794.410 01AAC005501 1907944
800118N	Deutz	Schlepper / Agrottron	6161	45	298	11		0.019.0794.4/10 00190794.410 01AAC005501 1907944
800369N	Deutz	Schlepper / Agrottron mk1	4.70	76		10	15	
800369N	Deutz	Schlepper / Agrottron mk1	4.80	76		10	15	
800369N	Deutz	Schlepper / Agrottron mk1	4.85	76		10	15	
800369N	Deutz	Schlepper / Agrottron mk1	4.90	76		10	15	
800369N	Deutz	Schlepper / Agrottron mk1	4.95	76		10	15	
800369N	Deutz	Schlepper / Agrottron mk1	6.00	76		10	15	
800369N	Deutz	Schlepper / Agrottron mk1	6.01	76		10	15	
800369N	Deutz	Schlepper / Agrottron mk1	6.05	76		10	15	
800369N	Deutz	Schlepper / Agrottron mk1	6.15	76		10	15	

Dasis Nr.	Hersteller	Modell	Typ	Außendurchmesser [mm]	Länge [mm]	Innengewinde 1 [mm]	Außengewinde 1 [mm]	für OE-Nummer
800369N	Deutz	Schlepper / Agrottron mk1	6.20	76		10	15	
800369N	Deutz	Schlepper / Agrottron mk1	6.30	76		10	15	
800369N	Deutz	Schlepper / Agrottron mk1	6.45	76		10	15	
800369N	Deutz	Schlepper / Agrottron mk2	80	76		10	15	
800369N	Deutz	Schlepper / Agrottron mk2	85	76		10	15	
800369N	Deutz	Schlepper / Agrottron mk2	90	76		10	15	
800369N	Deutz	Schlepper / Agrottron mk2	100	76		10	15	
800369N	Deutz	Schlepper / Agrottron mk2	105	76		10	15	
800369N	Deutz	Schlepper / Agrottron mk2	106	76		10	15	
800369N	Deutz	Schlepper / Agrottron mk2	110	76		10	15	
800369N	Deutz	Schlepper / Agrottron mk2	115	76		10	15	
800369N	Deutz	Schlepper / Agrottron mk2	120	76		10	15	
800369N	Deutz	Schlepper / Agrottron mk2	135	76		10	15	
800369N	Deutz	Schlepper / Agrottron mk2	150	76		10	15	
800369N	Deutz	Schlepper / Agrottron mk2	160	76		10	15	
800369N	Deutz	Schlepper / Agrottron mk2	175	76		10	15	
800369N	Deutz	Schlepper / Agrottron mk2	200	76		10	15	
800549N	Deutz	Schlepper / Agrottron mk2	230	76			15	
800549N	Deutz	Schlepper / Agrottron mk2	260	76			15	
800630N	Deutz	Schlepper / Agrottron mk3	80	63,5			10	
800369N	Deutz	Schlepper / Agrottron mk3	80	76		10	15	
800630N	Deutz	Schlepper / Agrottron mk3	85	63,5			10	
800369N	Deutz	Schlepper / Agrottron mk3	85	76		10	15	
800630N	Deutz	Schlepper / Agrottron mk3	90	63,5			10	
800369N	Deutz	Schlepper / Agrottron mk3	90	76		10	15	
800630N	Deutz	Schlepper / Agrottron mk3	90P	63,5			10	
800630N	Deutz	Schlepper / Agrottron mk3	100	63,5			10	
800369N	Deutz	Schlepper / Agrottron mk3	100	76		10	15	
800630N	Deutz	Schlepper / Agrottron mk3	100P	63,5			10	
800630N	Deutz	Schlepper / Agrottron mk3	105	63,5			10	
800369N	Deutz	Schlepper / Agrottron mk3	105	76		10	15	

Dasis Nr.	Hersteller	Modell	Typ	Außendurchmesser [mm]	Länge [mm]	Innengewinde 1 [mm]	Außengewinde 1 [mm]	für OE-Nummer
800630N	Deutz	Schlepper / Agrottron mk3	106	63,5			10	
800369N	Deutz	Schlepper / Agrottron mk3	106	76		10	15	
800630N	Deutz	Schlepper / Agrottron mk3	110	63,5			10	
800369N	Deutz	Schlepper / Agrottron mk3	110	76		10	15	
800630N	Deutz	Schlepper / Agrottron mk3	110P	63,5			10	
800630N	Deutz	Schlepper / Agrottron mk3	115	63,5			10	
800369N	Deutz	Schlepper / Agrottron mk3	115	76		10	15	
800630N	Deutz	Schlepper / Agrottron mk3	120	63,5			10	
800369N	Deutz	Schlepper / Agrottron mk3	120	76		10	15	
800630N	Deutz	Schlepper / Agrottron mk3	120P	63,5			10	
800630N	Deutz	Schlepper / Agrottron mk3	135	63,5			10	
800369N	Deutz	Schlepper / Agrottron mk3	135	76		10	15	
800630N	Deutz	Schlepper / Agrottron mk3	150	63,5			10	
800369N	Deutz	Schlepper / Agrottron mk3	150	76		10	15	
800630N	Deutz	Schlepper / Agrottron mk3	160	63,5			10	
800369N	Deutz	Schlepper / Agrottron mk3	160	76		10	15	
800630N	Deutz	Schlepper / Agrottron mk3	165	63,5			10	
800630N	Deutz	Schlepper / Agrottron mk3	175	63,5			10	
800369N	Deutz	Schlepper / Agrottron mk3	175	76		10	15	
800630N	Deutz	Schlepper / Agrottron mk3	200	63,5			10	
800369N	Deutz	Schlepper / Agrottron mk3	200	76		10	15	
800549N	Deutz	Schlepper / Agrottron mk3	230	76			15	
800549N	Deutz	Schlepper / Agrottron mk3	260	76			15	
800708N	Deutz	Schlepper / Agrottron TTV	6120.4	40	297			001908094
800708N	Deutz	Schlepper / Agrottron TTV	6130.4	40	297			001908094
800708N	Deutz	Schlepper / Agrottron TTV	6140	40	297			001908094
800708N	Deutz	Schlepper / Agrottron TTV	6140.4	40	297			001908094
800708N	Deutz	Schlepper / Agrottron TTV	6150.4	40	297			001908094
800118N	Deutz	Schlepper / Agrottron TTV	6160	45	298	11		0.019.0794.4/10 00190794.410 01AAC005501 1907944
800708N	Deutz	Schlepper / Agrottron TTV	6160.4	40	297			001908094

Dasis Nr.	Hersteller	Modell	Typ	Außendurchmesser [mm]	Länge [mm]	Innengewinde 1 [mm]	Außengewinde 1 [mm]	für OE-Nummer
800118N	Deutz	Schlepper / Agrottron TTV	6180	45	298	11		0.019.0794.4/10 00190794.410 01AAC005501 1907944
800118N	Deutz	Schlepper / Agrottron TTV	6190	45	298	11		0.019.0794.4/10 00190794.410 01AAC005501 1907944
800201N	Deutz	Schlepper / AgroXtra	3.57	76			10	
800201N	Deutz	Schlepper / AgroXtra	4.07	76			10	
800201N	Deutz	Schlepper / AgroXtra	4.17	76			10	
800201N	Deutz	Schlepper / AgroXtra	4.47	76			10	
800201N	Deutz	Schlepper / AgroXtra	4.57	76			10	
800201N	Deutz	Schlepper / AgroXtra	6.07	76			10	
800201N	Deutz	Schlepper / AgroXtra	6.17	76			10	
800201N	Deutz	Schlepper / DO7	2807	76			10	
800201N	Deutz	Schlepper / DO7	3607	76			10	
800201N	Deutz	Schlepper / DO7	4007	76			10	
800201N	Deutz	Schlepper / DO7	4507	76			10	
800201N	Deutz	Schlepper / DO7	4807	76			10	
800201N	Deutz	Schlepper / DO7	5207	76			10	
800201N	Deutz	Schlepper / DO7	6007	76			10	
800201N	Deutz	Schlepper / DO7	6207	76			10	
800201N	Deutz	Schlepper / DO7	6507	76			10	
800201N	Deutz	Schlepper / DO7	6807	76			10	
800201N	Deutz	Schlepper / DO7	6907	76			10	
800201N	Deutz	Schlepper / DO7	7007	76			10	
800201N	Deutz	Schlepper / DO7	7207	76			10	
800201N	Deutz	Schlepper / DO7	7807	76			10	
800201N	Deutz	Schlepper / DO7C	5207	76			10	
800201N	Deutz	Schlepper / DO7C	6007	76			10	
800201N	Deutz	Schlepper / DO7C	6207	76			10	
800201N	Deutz	Schlepper / DO7C	6507	76			10	
800201N	Deutz	Schlepper / DO7C	6807	76			10	
800201N	Deutz	Schlepper / DO7C	6907	76			10	

Dasis Nr.	Hersteller	Modell	Typ	Außendurchmesser [mm]	Länge [mm]	Innengewinde 1 [mm]	Außengewinde 1 [mm]	für OE-Nummer
800201N	Deutz	Schlepper / DO7C	7007	76			10	
800201N	Deutz	Schlepper / DO7C	7207	76			10	
800201N	Deutz	Schlepper / DO7C	7807	76			10	
800201N	Deutz	Schlepper / DX	80	76			10	
800201N	Deutz	Schlepper / DX	85	76			10	
800201N	Deutz	Schlepper / DX	86	76			10	
800201N	Deutz	Schlepper / DX	90	76			10	
800201N	Deutz	Schlepper / DX	92	76			10	
800201N	Deutz	Schlepper / DX	110	76			10	
800201N	Deutz	Schlepper / DX	120	76			10	
800201N	Deutz	Schlepper / DX	145	76			10	
800201N	Deutz	Schlepper / DX	160	76			10	
800201N	Deutz	Schlepper / DX	250	76			10	
800201N	Deutz	Schlepper / DX3	3.10	76			10	
800201N	Deutz	Schlepper / DX3	3.30	76			10	
800201N	Deutz	Schlepper / DX3	3.50	76			10	
800201N	Deutz	Schlepper / DX3	3.60	76			10	
800201N	Deutz	Schlepper / DX3	3.65	76			10	
800201N	Deutz	Schlepper / DX3	3.70	76			10	
800201N	Deutz	Schlepper / DX3	3.80	76			10	
800201N	Deutz	Schlepper / DX3	3.90	76			10	
800201N	Deutz	Schlepper / DX4	4.10	76			10	
800201N	Deutz	Schlepper / DX4	4.30	76			10	
800201N	Deutz	Schlepper / DX4	4.50	76			10	
800201N	Deutz	Schlepper / DX4	4.70	76			10	
800201N	Deutz	Schlepper / DX6	6.05	76			10	
800201N	Deutz	Schlepper / DX6	6.10	76			10	
800201N	Deutz	Schlepper / DX6	6.30	76			10	
800201N	Deutz	Schlepper / DX6	6.50	76			10	
800201N	Deutz	Schlepper / DX7	7.10	76			10	
800201N	Deutz	Schlepper / Hopfen	4.17	76			10	

Dasis Nr.	Hersteller	Modell	Typ	Außendurchmesser [mm]	Länge [mm]	Innengewinde 1 [mm]	Außengewinde 1 [mm]	für OE-Nummer
800201N	Deutz	Schlepper / Hopfen	4.57	76			10	
800201N	Deutz	Schlepper / Intrac	6.30	76			10	
800201N	Deutz	Schlepper / Intrac	6.60	76			10	
800201N	Deutz	Schlepper / Intrac	2002	76			10	
800201N	Deutz	Schlepper / Intrac	2003	76			10	
800201N	Deutz	Schlepper / Intrac	2004	76			10	
800064N	Fendt	Mähdrescher / 5220- 5275	5220	76			16	
800064N	Fendt	Mähdrescher / 5220- 5275	5250	76			16	
800064N	Fendt	Mähdrescher / 6270-6350	6300	76			16	
800064N	Fendt	Mähdrescher / 6270-6350	6350	76			16	
800531N	Fendt	Mähdrescher / Farmer 200	275V	76			14	
800531N	Fendt	Mähdrescher / Farmer 200	275VA	76			14	
800531N	Fendt	Mähdrescher / Farmer 200	280VA	76			14	
800531N	Fendt	Schlepper / Farmer 200	205P	76			14	
800531N	Fendt	Schlepper / Farmer 200	205PA	76			14	
800531N	Fendt	Schlepper / Farmer 200	206V	76			14	
800531N	Fendt	Schlepper / Farmer 200	206VA	76			14	
800531N	Fendt	Schlepper / Farmer 200	207V	76			14	
800531N	Fendt	Schlepper / Farmer 200	207VA	76			14	
800531N	Fendt	Schlepper / Farmer 200	208PA	76			14	
800531N	Fendt	Schlepper / Farmer 200	208VA	76			14	
800531N	Fendt	Schlepper / Farmer 200	209PA	76			14	
800531N	Fendt	Schlepper / Farmer 200	209VA	76			14	
800531N	Fendt	Schlepper / Farmer 200	250K	76			14	
800064N	Fendt	Schlepper / Farmer 200	250K	76			16	
800531N	Fendt	Schlepper / Farmer 200	250KA	76			14	
800064N	Fendt	Schlepper / Farmer 200	250KA	76			16	
800531N	Fendt	Schlepper / Farmer 200	250LE	76			14	
800064N	Fendt	Schlepper / Farmer 200	250LE	76			16	
800531N	Fendt	Schlepper / Farmer 200	250S	76			14	
800064N	Fendt	Schlepper / Farmer 200	250S	76			16	

Dasis Nr.	Hersteller	Modell	Typ	Außendurchmesser [mm]	Länge [mm]	Innengewinde 1 [mm]	Außengewinde 1 [mm]	für OE-Nummer
800531N	Fendt	Schlepper / Farmer 200	250SA	76			14	
800064N	Fendt	Schlepper / Farmer 200	250SA	76			16	
800531N	Fendt	Schlepper / Farmer 200	250V	76			14	
800531N	Fendt	Schlepper / Farmer 200	250VA	76			14	
800531N	Fendt	Schlepper / Farmer 200	260P	76			14	
800531N	Fendt	Schlepper / Farmer 200	260PA	76			14	
800531N	Fendt	Schlepper / Farmer 200	260S	76			14	
800064N	Fendt	Schlepper / Farmer 200	260S	76			16	
800531N	Fendt	Schlepper / Farmer 200	260SA	76			14	
800064N	Fendt	Schlepper / Farmer 200	260SA	76			16	
800531N	Fendt	Schlepper / Farmer 200	260V	76			14	
800531N	Fendt	Schlepper / Farmer 200	260VA	76			14	
800531N	Fendt	Schlepper / Farmer 200	270P	76			14	
800531N	Fendt	Schlepper / Farmer 200	270PA	76			14	
800531N	Fendt	Schlepper / Farmer 200	270V	76			14	
800531N	Fendt	Schlepper / Farmer 200	270VA	76			14	
800531N	Fendt	Schlepper / Farmer 200	275SA	76			14	
800064N	Fendt	Schlepper / Farmer 200	275SA	76			16	
800531N	Fendt	Schlepper / Farmer 200	275V	76			14	
800531N	Fendt	Schlepper / Farmer 200	275VA	76			14	
800531N	Fendt	Schlepper / Farmer 200	280P	76			14	
800531N	Fendt	Schlepper / Farmer 200	280PA	76			14	
800531N	Fendt	Schlepper / Farmer 200	280S	76			14	
800064N	Fendt	Schlepper / Farmer 200	280S	76			16	
800531N	Fendt	Schlepper / Farmer 200	280SA	76			14	
800064N	Fendt	Schlepper / Farmer 200	280SA	76			16	
800531N	Fendt	Schlepper / Farmer 200	280VA	76			14	
800064N	Fendt	Schlepper / Farmer 300	303LS	76			16	
800064N	Fendt	Schlepper / Farmer 300	303LSA	76			16	
800064N	Fendt	Schlepper / Farmer 300	304LS	76			16	
800064N	Fendt	Schlepper / Farmer 300	304LSA	76			16	

Dasis Nr.	Hersteller	Modell	Typ	Außendurchmesser [mm]	Länge [mm]	Innengewinde 1 [mm]	Außengewinde 1 [mm]	für OE-Nummer
800064N	Fendt	Schlepper / Farmer 300	305LS	76			16	
800064N	Fendt	Schlepper / Farmer 300	305LSA	76			16	
800064N	Fendt	Schlepper / Farmer 300	306LS	76			16	
800064N	Fendt	Schlepper / Farmer 300	306LSA	76			16	
800432N	Fendt	Schlepper / Farmer 300	307	50				
800064N	Fendt	Schlepper / Farmer 300	307	76			16	
800201N	Fendt	Schlepper / Farmer 300	307LS	76			10	
800064N	Fendt	Schlepper / Farmer 300	307LS	76			16	
800201N	Fendt	Schlepper / Farmer 300	307LSA	76			10	
800064N	Fendt	Schlepper / Farmer 300	307LSA	76			16	
800201N	Fendt	Schlepper / Farmer 300	307LSE	76			10	
800432N	Fendt	Schlepper / Farmer 300	308	50				
800064N	Fendt	Schlepper / Farmer 300	308	76			16	
800201N	Fendt	Schlepper / Farmer 300	308LS	76			10	
800064N	Fendt	Schlepper / Farmer 300	308LS	76			16	
800201N	Fendt	Schlepper / Farmer 300	308LSA	76			10	
800064N	Fendt	Schlepper / Farmer 300	308LSA	76			16	
800201N	Fendt	Schlepper / Farmer 300	308LSE	76			10	
800064N	Fendt	Schlepper / Farmer 300	308LSE	76			16	
800432N	Fendt	Schlepper / Farmer 300	309	50				
800064N	Fendt	Schlepper / Farmer 300	309	76			16	
800201N	Fendt	Schlepper / Farmer 300	309LS	76			10	
800064N	Fendt	Schlepper / Farmer 300	309LS	76			16	
800201N	Fendt	Schlepper / Farmer 300	309LSA	76			10	
800064N	Fendt	Schlepper / Farmer 300	309LSA	76			16	
800201N	Fendt	Schlepper / Farmer 300	309LSE	76			10	
800064N	Fendt	Schlepper / Farmer 300	309LSE	76			16	
800201N	Fendt	Schlepper / Farmer 300	310LSA	76			10	
800064N	Fendt	Schlepper / Farmer 300	310LSA	76			16	
800201N	Fendt	Schlepper / Farmer 300	310LSE	76			10	
800064N	Fendt	Schlepper / Farmer 300	310LSE	76			16	



Dasis Nr.	Hersteller	Modell	Typ	Außendurchmesser [mm]	Länge [mm]	Innengewinde 1 [mm]	Außengewinde 1 [mm]	für OE-Nummer
800201N	Fendt	Schlepper / Farmer 300	311LSA	76			10	
800064N	Fendt	Schlepper / Farmer 300	311LSA	76			16	
800201N	Fendt	Schlepper / Farmer 300	311LSE	76			10	
800064N	Fendt	Schlepper / Farmer 300	311LSE	76			16	
800201N	Fendt	Schlepper / Farmer 300	312LSA	76			10	
800064N	Fendt	Schlepper / Farmer 300	312LSA	76			16	
800201N	Fendt	Schlepper / Farmer 300	312LSE	76			10	
800064N	Fendt	Schlepper / Farmer 300	312LSE	76			16	
800432N	Fendt	Schlepper / Farmer 400	409	50				
800432N	Fendt	Schlepper / Farmer 400	410	50				
800432N	Fendt	Schlepper / Farmer 400	411	50				
800432N	Fendt	Schlepper / Farmer 400	412	50				
800201N	Fendt	Schlepper / Favorit 500	509	76			10	
800201N	Fendt	Schlepper / Favorit 500	510	76			10	
800201N	Fendt	Schlepper / Favorit 500	511	76			10	
800201N	Fendt	Schlepper / Favorit 500	512	76			10	
800201N	Fendt	Schlepper / Favorit 500	514	76			10	
800201N	Fendt	Schlepper / Favorit 500	515	76			10	
800396N	Fendt	Schlepper / Favorit 600	611LS	80			18	
800396N	Fendt	Schlepper / Favorit 600	611LSA	80			18	
800396N	Fendt	Schlepper / Favorit 600	611S	80			18	
800396N	Fendt	Schlepper / Favorit 600	611SA	80			18	
800396N	Fendt	Schlepper / Favorit 600	612LSA	80			18	
800396N	Fendt	Schlepper / Favorit 600	612SA	80			18	
800396N	Fendt	Schlepper / Favorit 600	614LSA	80			18	
800396N	Fendt	Schlepper / Favorit 600	614SA	80			18	
800396N	Fendt	Schlepper / Favorit 600	615LSA	80			18	
800396N	Fendt	Schlepper / Favorit 600	615SA	80			18	
800432N	Fendt	Schlepper / Favorit 700	711	50				
800432N	Fendt	Schlepper / Favorit 700	712	50				
800432N	Fendt	Schlepper / Favorit 700	714	50				

Dasis Nr.	Hersteller	Modell	Typ	Außendurchmesser [mm]	Länge [mm]	Innengewinde 1 [mm]	Außengewinde 1 [mm]	für OE-Nummer
800432N	Fendt	Schlepper / Favorit 700	716	50				
800432N	Fendt	Schlepper / Favorit 800	815	50				
800201N	Fendt	Schlepper / Favorit 800	815	76			10	
800064N	Fendt	Schlepper / Favorit 800	815	76			16	
800432N	Fendt	Schlepper / Favorit 800	816	50				
800201N	Fendt	Schlepper / Favorit 800	816	76			10	
800064N	Fendt	Schlepper / Favorit 800	816	76			16	
800432N	Fendt	Schlepper / Favorit 800	817	50				
800201N	Fendt	Schlepper / Favorit 800	817	76			10	
800064N	Fendt	Schlepper / Favorit 800	817	76			16	
800432N	Fendt	Schlepper / Favorit 800	818	50				
800201N	Fendt	Schlepper / Favorit 800	818	76			10	
800064N	Fendt	Schlepper / Favorit 800	818	76			16	
800432N	Fendt	Schlepper / Favorit 800	823	50				
800201N	Fendt	Schlepper / Favorit 800	823	76			10	
800064N	Fendt	Schlepper / Favorit 800	823	76			16	
800201N	Fendt	Schlepper / Favorit 900	916	76			10	
800201N	Fendt	Schlepper / Favorit 900	918	76			10	
800201N	Fendt	Schlepper / Favorit 900	920	76			10	
800201N	Fendt	Schlepper / Favorit 900	924	76			10	
800201N	Fendt	Schlepper / Favorit 900	926	76			10	
800201N	Fendt	Schlepper / Favorit 900	926PL	76			10	
800432N	Fendt	Schlepper / Favorit 900	930	50				
800432N	Fendt	Schlepper / GT300	370	50				
800432N	Fendt	Schlepper / GT300	380	50				
800531N	Fendt	Schlepper / GT300	390	76			14	
800531N	Fendt	Schlepper / GT300	395	76			14	
800432N	Fendt	Schlepper / GT300	A370	50				
800432N	Fendt	Schlepper / GT300	A380	50				
800531N	Fendt	Schlepper / GT300	A390	76			14	
800531N	Fendt	Schlepper / GT300	A395	76			14	

Dasis Nr.	Hersteller	Modell	Typ	Außendurchmesser [mm]	Länge [mm]	Innengewinde 1 [mm]	Außengewinde 1 [mm]	für OE-Nummer
800709N	Fendt	Schlepper / MT	1149MT	76	229			593052D2
800709N	Fendt	Schlepper / MT	1154MT	76	229			593052D2
800709N	Fendt	Schlepper / MT	1159MT	76	229			593052D2
800709N	Fendt	Schlepper / MT	1165MT	76	229			593052D2
800709N	Fendt	Schlepper / Rogator	635	76	229			593052D2
800709N	Fendt	Schlepper / Rogator	645	76	229			593052D2
800709N	Fendt	Schlepper / Rogator	655	76	229			593052D2
800961N	Fendt	Schlepper / Vario 200 V/F/P Serie	208 V/F					F334550010060
800961N	Fendt	Schlepper / Vario 200 V/F/P Serie	209 V/F/P					F334550010060
800961N	Fendt	Schlepper / Vario 200 V/F/P Serie	210 V/F/P					F334550010060
800961N	Fendt	Schlepper / Vario 200 V/F/P Serie	211 V/F/P					F334550010060
800201N	Fendt	Schlepper / Xylon	520	76			10	
800201N	Fendt	Schlepper / Xylon	522	76			10	
800201N	Fendt	Schlepper / Xylon	524	76			10	
800204N	Fiat / Hitachi	Feldhäcksler ....-70	670	76				
800204N	Fiat / Hitachi	Feldhäcksler ....-70	670T	76				
800154N	Fiat / Hitachi	Schlepper ....-80	580	62				
800154N	Fiat / Hitachi	Schlepper ....-80	580DT	62				
800154N	Fiat / Hitachi	Schlepper ....-80	680	62				
800154N	Fiat / Hitachi	Schlepper ....-80	680DT	62				
800154N	Fiat / Hitachi	Schlepper ....-80	780	62				
800154N	Fiat / Hitachi	Schlepper ....-80	780DT	62				
800154N	Fiat / Hitachi	Schlepper ....-80	880	62				
800154N	Fiat / Hitachi	Schlepper ....-80	880-5	62				
800154N	Fiat / Hitachi	Schlepper ....-80	880DT	62				
800154N	Fiat / Hitachi	Schlepper ....-80	980	62				
800154N	Fiat / Hitachi	Schlepper ....-80	980DT	62				
800154N	Fiat / Hitachi	Schlepper ....-80	1180	62				
800154N	Fiat / Hitachi	Schlepper ....-80	1180DT	62				
800154N	Fiat / Hitachi	Schlepper ....-80	1180T	62				

Dasis Nr.	Hersteller	Modell	Typ	Außendurchmesser [mm]	Länge [mm]	Innengewinde 1 [mm]	Außengewinde 1 [mm]	für OE-Nummer
800154N	Fiat / Hitachi	Schlepper ....-80	1280DT	62				
800154N	Fiat / Hitachi	Schlepper ....-80	1280T	62				
800154N	Fiat / Hitachi	Schlepper ....-80	1380DT	62				
800154N	Fiat / Hitachi	Schlepper ....-80	1580	62				
800154N	Fiat / Hitachi	Schlepper ....-80	1580DT	62				
800154N	Fiat / Hitachi	Schlepper ....-80	1580DTTurbo	62				
800154N	Fiat / Hitachi	Schlepper ....-80	1580T	62				
800154N	Fiat / Hitachi	Schlepper ....-80	1580Turbo	62				
800154N	Fiat / Hitachi	Schlepper ....-80	1880	62				
800154N	Fiat / Hitachi	Schlepper ....-80	1880DT	62				
800154N	Fiat / Hitachi	Schlepper ....-80	1880T	62				
800154N	Fiat / Hitachi	Schlepper ....-90	55-90DT	62				
800154N	Fiat / Hitachi	Schlepper ....-90	60-90DT	62				
800154N	Fiat / Hitachi	Schlepper ....-90	65-90DT	62				
800154N	Fiat / Hitachi	Schlepper ....-90	70-90DT	62				
800154N	Fiat / Hitachi	Schlepper ....-90	80-90DT	62				
800154N	Fiat / Hitachi	Schlepper ....-90	85-90DT	62				
800154N	Fiat / Hitachi	Schlepper ....-90	90-90DT	62				
800154N	Fiat / Hitachi	Schlepper ....-90	95-90DT	62				
800154N	Fiat / Hitachi	Schlepper ....-90	100-90DT	62				
800154N	Fiat / Hitachi	Schlepper ....-90	110-90DT	62				
800154N	Fiat / Hitachi	Schlepper ....-90	115-90DT	62				
800154N	Fiat / Hitachi	Schlepper ....-90	130-90	62				
800154N	Fiat / Hitachi	Schlepper ....-90	130-90DT	62				
800154N	Fiat / Hitachi	Schlepper ....-90	140-90	62				
800154N	Fiat / Hitachi	Schlepper ....-90	140-90DT	62				
800154N	Fiat / Hitachi	Schlepper ....-90	160-90	62				
800154N	Fiat / Hitachi	Schlepper ....-90	160-90DT	62				
800154N	Fiat / Hitachi	Schlepper ....-90	180-90	62				
800154N	Fiat / Hitachi	Schlepper ....-90	180-90DT	62				
800154N	Fiat / Hitachi	Schlepper ....-94	60-94	62				

Dasis Nr.	Hersteller	Modell	Typ	Außendurchmesser [mm]	Länge [mm]	Innengewinde 1 [mm]	Außengewinde 1 [mm]	für OE-Nummer
800154N	Fiat / Hitachi	Schlepper ....-94	60-94DT	62				
800154N	Fiat / Hitachi	Schlepper ....-94	65-94	62				
800154N	Fiat / Hitachi	Schlepper ....-94	65-94DT	62				
800154N	Fiat / Hitachi	Schlepper ....-94	72-94	62				
800154N	Fiat / Hitachi	Schlepper ....-94	72-94DT	62				
800154N	Fiat / Hitachi	Schlepper ....-94	82-94	62				
800154N	Fiat / Hitachi	Schlepper ....-94	82-94DT	62				
800154N	Fiat / Hitachi	Schlepper ....-94	88-94	62				
800154N	Fiat / Hitachi	Schlepper ....-94	88-94DT	62				
800056N	Fiat / Hitachi	Schlepper / 9600	9630	102			21	
800056N	Fiat / Hitachi	Schlepper / 9600	9640	102			21	
800056N	Fiat / Hitachi	Schlepper / 9600	9645	102			21	
800154N	Fiat / Hitachi	Schlepper / F	100	62				
800154N	Fiat / Hitachi	Schlepper / F	100DT	62				
800154N	Fiat / Hitachi	Schlepper / F	110	62				
800154N	Fiat / Hitachi	Schlepper / F	110DT	62				
800154N	Fiat / Hitachi	Schlepper / F	115	62				
800154N	Fiat / Hitachi	Schlepper / F	115DT	62				
800154N	Fiat / Hitachi	Schlepper / F	120	62				
800154N	Fiat / Hitachi	Schlepper / F	120DT	62				
800154N	Fiat / Hitachi	Schlepper / F	130	62				
800154N	Fiat / Hitachi	Schlepper / F	130DT	62				
800154N	Fiat / Hitachi	Schlepper / F	140	62				
800154N	Fiat / Hitachi	Schlepper / F	140DT	62				
800204N	Fiat / Hitachi	Schlepper / G	170	76				
800204N	Fiat / Hitachi	Schlepper / G	190	76				
800204N	Fiat / Hitachi	Schlepper / G	210	76				
800204N	Fiat / Hitachi	Schlepper / G	240	76				
800154N	Fiat / Hitachi	Schlepper / L	60	62				
800154N	Fiat / Hitachi	Schlepper / L	65	62				
800154N	Fiat / Hitachi	Schlepper / L	75	62				

Dasis Nr.	Hersteller	Modell	Typ	Außendurchmesser [mm]	Länge [mm]	Innengewinde 1 [mm]	Außengewinde 1 [mm]	für OE-Nummer
800154N	Fiat / Hitachi	Schlepper / L	85	62				
800154N	Fiat / Hitachi	Schlepper / L	95	62				
800215N	Fiat / Hitachi	Schlepper / M	100	76		14	15	
800215N	Fiat / Hitachi	Schlepper / M	115	76		14	15	
800215N	Fiat / Hitachi	Schlepper / M	135	76		14	15	
800215N	Fiat / Hitachi	Schlepper / M	160	76		14	15	
800215N	Fiat / Hitachi	Schlepper / M	180	76		14	15	
800372N	Gregoire	Schlepper / G	G10	76				
800372N	Gregoire	Schlepper / G	G84	76				
800543N	Hyundai	Bagger / Robex	200LC	70			10	
800543N	Hyundai	Schaufellader / HM	190	70			10	
800543N	Hyundai	Schaufellader / HM	198	70			10	
800064N	JCB	Baggerlader / 400	406	76			16	
800064N	JCB	Baggerlader / 400	407	76			16	
800064N	JCB	Baggerlader / 400	409	76			16	
800064N	JCB	Baggerlader / 400	411	76			16	
800064N	JCB	Baggerlader / 400	411B	76			16	
800064N	JCB	Baggerlader / 400	412	76			16	
800064N	JCB	Baggerlader / 400	412S	76			16	
800064N	JCB	Baggerlader / 400	414S	76			16	
800064N	JCB	Baggerlader / 400	415	76			16	
800064N	JCB	Baggerlader / 400	416	76			16	
800064N	JCB	Baggerlader / 400	416B	76			16	
800064N	JCB	Baggerlader / 400	416S	76			16	
800064N	JCB	Baggerlader / 400	420	76			16	
800064N	JCB	Baggerlader / 400	425	76			16	
800064N	JCB	Baggerlader / 400	426	76			16	
800064N	JCB	Baggerlader / 400	426B	76			16	
800064N	JCB	Baggerlader / 400	430	76			16	
800064N	JCB	Baggerlader / 400	435	76			16	
800064N	JCB	Baggerlader / 400	436	76			16	

Dasis Nr.	Hersteller	Modell	Typ	Außendurchmesser [mm]	Länge [mm]	Innengewinde 1 [mm]	Außengewinde 1 [mm]	für OE-Nummer
800064N	JCB	Baggerlader / 400	436B	76			16	
800064N	JCB	Baggerlader / 400	446	76			16	
800064N	JCB	Baggerlader / 400	446B	76			16	
800055N	JCB	Baggerlader / 400	456	76			15,6	
800055N	JCB	Schlepper / Fastrac 100	125	76			15,6	
800055N	JCB	Schlepper / Fastrac 100	125-65	76			15,6	
800055N	JCB	Schlepper / Fastrac 100	130	76			15,6	
800055N	JCB	Schlepper / Fastrac 100	130-65	76			15,6	
800055N	JCB	Schlepper / Fastrac 100	135	76			15,6	
800055N	JCB	Schlepper / Fastrac 100	145	76			15,6	
800055N	JCB	Schlepper / Fastrac 100	145-65	76			15,6	
800055N	JCB	Schlepper / Fastrac 100	150	76			15,6	
800055N	JCB	Schlepper / Fastrac 100	150-65	76			15,6	
800055N	JCB	Schlepper / Fastrac 100	155	76			15,6	
800055N	JCB	Schlepper / Fastrac 100	185	76			15,6	
800055N	JCB	Schlepper / Fastrac 1000	1115	76			15,6	
800340N	JCB	Schlepper / Fastrac 1000	1115	89		25		
800055N	JCB	Schlepper / Fastrac 1000	1115S	76			15,6	
800340N	JCB	Schlepper / Fastrac 1000	1115S	89		25		
800055N	JCB	Schlepper / Fastrac 1000	1125	76			15,6	
800340N	JCB	Schlepper / Fastrac 1000	1125	89		25		
800055N	JCB	Schlepper / Fastrac 1000	1135	76			15,6	
800340N	JCB	Schlepper / Fastrac 1000	1135	89		25		
800055N	JCB	Schlepper / Fastrac 2000	2115	76			15,6	
800340N	JCB	Schlepper / Fastrac 2000	2115	89		25		
800055N	JCB	Schlepper / Fastrac 2000	2125	76			15,6	
800340N	JCB	Schlepper / Fastrac 2000	2125	89		25		
800055N	JCB	Schlepper / Fastrac 2000	2135	76			15,6	
800340N	JCB	Schlepper / Fastrac 2000	2135	89		25		
800055N	JCB	Schlepper / Fastrac 2000	2150	76			15,6	
800340N	JCB	Schlepper / Fastrac 2000	2150	89		25		

Dasis Nr.	Hersteller	Modell	Typ	Außendurchmesser [mm]	Länge [mm]	Innengewinde 1 [mm]	Außengewinde 1 [mm]	für OE-Nummer
803510N	JCB	Teleskoplader / 500 Serie	504B	45			15	
803510N	JCB	Teleskoplader / 500 Serie	506	45			15	
803510N	JCB	Teleskoplader / 500 Serie	506B	45			15	
803510N	JCB	Teleskoplader / 500 Serie	506C	45			15	
803510N	JCB	Teleskoplader / 500 Serie	506CHL	45			15	
803510N	JCB	Teleskoplader / 500 Serie	506HL	45			15	
803510N	JCB	Teleskoplader / 500 Serie	508C	45			15	
803510N	JCB	Teleskoplader / 500 Serie	520	45			15	
803510N	JCB	Teleskoplader / 500 Serie	520HL	45			15	
803510N	JCB	Teleskoplader / 500 Serie	520M	45			15	
803510N	JCB	Teleskoplader / 500 Serie	520S	45			15	
803510N	JCB	Teleskoplader / 500 Serie	525	45			15	
803510N	JCB	Teleskoplader / 500 Serie	525B	45			15	
803510N	JCB	Teleskoplader / 500 Serie	525BHL	45			15	
803510N	JCB	Teleskoplader / 500 Serie	525HL	45			15	
803510N	JCB	Teleskoplader / 500 Serie	526	45			15	
803510N	JCB	Teleskoplader / 500 Serie	526S	45			15	
803510N	JCB	Teleskoplader / 500 Serie	528AG	45			15	
803510N	JCB	Teleskoplader / 500 Serie	528S	45			15	
803510N	JCB	Teleskoplader / 500 Serie	530	45			15	
803510N	JCB	Teleskoplader / 500 Serie	530B	45			15	
803510N	JCB	Teleskoplader / 500 Serie	530BHL	45			15	
803510N	JCB	Teleskoplader / 500 Serie	530FS	45			15	
803510N	JCB	Teleskoplader / 500 Serie	530FSPlus	45			15	
803510N	JCB	Teleskoplader / 500 Serie	530FSSUPER	45			15	
803510N	JCB	Teleskoplader / 500 Serie	530HL	45			15	
803510N	JCB	Teleskoplader / 500 Serie	530S	45			15	
803510N	JCB	Teleskoplader / 500 Serie	530SL	45			15	
803510N	JCB	Teleskoplader / 500 Serie	530SUPERAG	45			15	
803510N	JCB	Teleskoplader / 500 Serie	530S XL	45			15	
803510N	JCB	Teleskoplader / 500 Serie	531S	45			15	



Dasis Nr.	Hersteller	Modell	Typ	Außendurchmesser [mm]	Länge [mm]	Innengewinde 1 [mm]	Außengewinde 1 [mm]	für OE-Nummer
803510N	JCB	Teleskoplader / 500 Serie	532	45			15	
803510N	JCB	Teleskoplader / 500 Serie	532H	45			15	
803510N	JCB	Teleskoplader / 500 Serie	535	45			15	
803510N	JCB	Teleskoplader / 500 Serie	537	45			15	
803510N	JCB	Teleskoplader / 500 Serie	537H	45			15	
803510N	JCB	Teleskoplader / 500 Serie	540	45			15	
803510N	JCB	Teleskoplader / 500 Serie	540B	45			15	
803510N	JCB	Teleskoplader / 500 Serie	540BM	45			15	
803510N	JCB	Teleskoplader / 500 Serie	540FS	45			15	
803510N	JCB	Teleskoplader / 500 Serie	540FSPlus	45			15	
803510N	JCB	Teleskoplader / 500 Serie	540FSSUPER	45			15	
803510N	JCB	Teleskoplader / 500 Serie	540S	45			15	
803510N	JCB	Teleskoplader / 500 Serie	540SL	45			15	
803510N	JCB	Teleskoplader / 500 Serie	540SUPERAG	45			15	
803510N	JCB	Teleskoplader / 500 Serie	540S XL	45			15	
803510N	JCB	Teleskoplader / 500 Serie	550	45			15	
803510N	JCB	Teleskoplader / 500 Serie	5508	45			15	
802110N	JCB	Teleskoplader / SXL	530	63,5			11	
802110N	JCB	Teleskoplader / SXL	540	63,5			11	
800017N	John Deere	Baggerlader / 110-726B	310	102		15	10	
800017N	John Deere	Baggerlader / 110-726B	310E	102		15	10	
800017N	John Deere	Baggerlader / 110-726B	310G	102		15	10	
800017N	John Deere	Baggerlader / 110-726B	310SE	102		15	10	
800017N	John Deere	Baggerlader / 110-726B	310SG	102		15	10	
800017N	John Deere	Baggerlader / 110-726B	315	102		15	10	
800017N	John Deere	Baggerlader / 110-726B	315SG	102		15	10	
800017N	John Deere	Baggerlader / 110-726B	410	102		15	10	
800017N	John Deere	Baggerlader / 110-726B	410B	102		15	10	
800017N	John Deere	Baggerlader / 110-726B	410E	102		15	10	
800017N	John Deere	Baggerlader / 110-726B	410G	102		15	10	
800017N	John Deere	Baggerlader / 110-726B	510	102		15	10	

Dasis Nr.	Hersteller	Modell	Typ	Außendurchmesser [mm]	Länge [mm]	Innengewinde 1 [mm]	Außengewinde 1 [mm]	für OE-Nummer
800017N	John Deere	Baggerlader / 110-726B	510B	102		15	10	
800017N	John Deere	Baggerlader / 110-726B	544J	102		15	10	
800017N	John Deere	Baggerlader / 110-726B	624G	102		15	10	
800017N	John Deere	Baggerlader / 110-726B	710	102		15	10	
800015N	John Deere	Baggerlader / 110-726B	726B	102				
800015N	John Deere	Feldhäcksler / 3400-3420	3400	102				
800015N	John Deere	Feldhäcksler / 3400-3420	3415	102				
800015N	John Deere	Feldhäcksler / 3400-3420	3420	102				
800178N	John Deere	Feldhäcksler / 5030-5730	5200	102		9	15	
800178N	John Deere	Feldhäcksler / 5030-5730	5400	102		9	15	
800015N	John Deere	Feldhäcksler / 5030-5730	5720	102				
800015N	John Deere	Feldhäcksler / 5030-5730	5730	102				
800178N	John Deere	Feldhäcksler / 6010-6950	6610	102		9	15	
800178N	John Deere	Feldhäcksler / 6010-6950	6650	102		9	15	
800178N	John Deere	Feldhäcksler / 6010-6950	6710	102		9	15	
800178N	John Deere	Feldhäcksler / 6010-6950	6750	102		9	15	
800178N	John Deere	Feldhäcksler / 6010-6950	6810	102		9	15	
800178N	John Deere	Feldhäcksler / 6010-6950	6850	102		9	15	
800178N	John Deere	Feldhäcksler / 6010-6950	6910	102		9	15	
800178N	John Deere	Feldhäcksler / 6010-6950	6950	102		9	15	
800015N	John Deere	Mähdrescher / 900-1188	955	102				
800015N	John Deere	Mähdrescher / 900-1188	965	102				
800015N	John Deere	Mähdrescher / 900-1188	975	102				
800015N	John Deere	Mähdrescher / 900-1188	985	102				
800015N	John Deere	Mähdrescher / 900-1188	1052	102				
800015N	John Deere	Mähdrescher / 900-1188	1055	102				
800015N	John Deere	Mähdrescher / 900-1188	1065	102				
800015N	John Deere	Mähdrescher / 900-1188	1068H	102				
800015N	John Deere	Mähdrescher / 900-1188	1072	102				
800015N	John Deere	Mähdrescher / 900-1188	1075	102				
800015N	John Deere	Mähdrescher / 900-1188	1075H4	102				

Dasis Nr.	Hersteller	Modell	Typ	Außendurchmesser [mm]	Länge [mm]	Innengewinde 1 [mm]	Außengewinde 1 [mm]	für OE-Nummer
800015N	John Deere	Mähdrescher / 900-1188	1085	102				
800015N	John Deere	Mähdrescher / 900-1188	1085H4	102				
800017N	John Deere	Mähdrescher / 900-1188	1155	102		15	10	
800017N	John Deere	Mähdrescher / 900-1188	1157	102		15	10	
800017N	John Deere	Mähdrescher / 900-1188	1158	102		15	10	
800017N	John Deere	Mähdrescher / 900-1188	1166	102		15	10	
800017N	John Deere	Mähdrescher / 900-1188	1169	102		15	10	
800017N	John Deere	Mähdrescher / 900-1188	1169H	102		15	10	
800017N	John Deere	Mähdrescher / 900-1188	1169H4	102		15	10	
800064N	John Deere	Mähdrescher / 900-1188	1170	76			16	
800017N	John Deere	Mähdrescher / 900-1188	1170	102		15	10	
800017N	John Deere	Mähdrescher / 900-1188	1174	102		15	10	
800017N	John Deere	Mähdrescher / 900-1188	1175	102		15	10	
800017N	John Deere	Mähdrescher / 900-1188	1177	102		15	10	
800017N	John Deere	Mähdrescher / 900-1188	1177H4	102		15	10	
800017N	John Deere	Mähdrescher / 900-1188	1188	102		15	10	
800017N	John Deere	Mähdrescher / 900-1188	1188H4	102		15	10	
800178N	John Deere	Mähdrescher / 2000-2266	2054	102		9	15	
800178N	John Deere	Mähdrescher / 2000-2266	2056	102		9	15	
800178N	John Deere	Mähdrescher / 2000-2266	2058	102		9	15	
800178N	John Deere	Mähdrescher / 2000-2266	2064	102		9	15	
800178N	John Deere	Mähdrescher / 2000-2266	2066	102		9	15	
800017N	John Deere	Mähdrescher / 4000-8850	4400	102		15	10	
800017N	John Deere	Mähdrescher / 4000-8850	6600	102		15	10	
800017N	John Deere	Mähdrescher / 4000-8850	7455	102		15	10	
800017N	John Deere	Mähdrescher / 4000-8850	7700	102		15	10	
800017N	John Deere	Mähdrescher / 4000-8850	7720	102		15	10	
800017N	John Deere	Mähdrescher / 4000-8850	7722	102		15	10	
800017N	John Deere	Mähdrescher / 4000-8850	8820	102		15	10	
800017N	John Deere	Mähdrescher / 9000-9980	9400	102		15	10	
800017N	John Deere	Mähdrescher / 9000-9980	9410	102		15	10	

Dasis Nr.	Hersteller	Modell	Typ	Außendurchmesser [mm]	Länge [mm]	Innengewinde 1 [mm]	Außengewinde 1 [mm]	für OE-Nummer
800017N	John Deere	Mähdrescher / 9000-9980	9450	102		15	10	
800017N	John Deere	Mähdrescher / 9000-9980	9500	102		15	10	
800017N	John Deere	Mähdrescher / 9000-9980	9510	102		15	10	
800017N	John Deere	Mähdrescher / 9000-9980	9540	102		15	10	
800017N	John Deere	Mähdrescher / 9000-9980	9550	102		15	10	
800017N	John Deere	Mähdrescher / 9000-9980	9560	102		15	10	
800017N	John Deere	Mähdrescher / 9000-9980	9600	102		15	10	
800017N	John Deere	Mähdrescher / 9000-9980	9640	102		15	10	
800017N	John Deere	Mähdrescher / 9000-9980	9650	102		15	10	
800017N	John Deere	Mähdrescher / 9000-9980	9750	102		15	10	
800017N	John Deere	Mähdrescher / 9000-9980	9930	102		15	10	
800017N	John Deere	Mähdrescher / 9000-9980	9950	102		15	10	
800017N	John Deere	Mähdrescher / 9000-9980	9960	102		15	10	
800017N	John Deere	Mähdrescher / 9000-9980	9980	102		15	10	
800017N	John Deere	Mähdrescher / CTS	1100	102		15	10	
800017N	John Deere	Mähdrescher / CTS	2200	102		15	10	
800017N	John Deere	Mähdrescher / CTS	2300	102		15	10	
800017N	John Deere	Mähdrescher / CTS	2400	102		15	10	
800017N	John Deere	Mähdrescher / CTS	3400	102		15	10	
800017N	John Deere	Mähdrescher / CTS	3800	102		15	10	
800017N	John Deere	Mähdrescher / CTS	4400	102		15	10	
800017N	John Deere	Mähdrescher / CTS	4700	102		15	10	
800017N	John Deere	Mähdrescher / CTS	6600	102		15	10	
800017N	John Deere	Mähdrescher / CTS	7400	102		15	10	
800017N	John Deere	Mähdrescher / CTS	7700	102		15	10	
800017N	John Deere	Mähdrescher / CTS	8800	102		15	10	
800017N	John Deere	Mähdrescher / CTS	9000	102		15	10	
800017N	John Deere	Minibagger / 200-800	317	102		15	10	
800017N	John Deere	Minibagger / 200-800	320	102		15	10	
800017N	John Deere	Minibagger / 200-800	325	102		15	10	
800017N	John Deere	Minibagger / 200-800	328	102		15	10	

Dasis Nr.	Hersteller	Modell	Typ	Außendurchmesser [mm]	Länge [mm]	Innengewinde 1 [mm]	Außengewinde 1 [mm]	für OE-Nummer
800017N	John Deere	Minibagger / 200-800	360	102		15	10	
800017N	John Deere	Minibagger / 200-800	460	102		15	10	
800017N	John Deere	Minibagger / 200-800	531S	102		15	10	
800017N	John Deere	Minibagger / 200-800	540E	102		15	10	
800017N	John Deere	Minibagger / 200-800	540G	102		15	10	
800017N	John Deere	Minibagger / 200-800	548E	102		15	10	
800017N	John Deere	Minibagger / 200-800	640E	102		15	10	
800017N	John Deere	Minibagger / 200-800	640G	102		15	10	
800017N	John Deere	Minibagger / 200-800	648E	102		15	10	
800017N	John Deere	Minibagger / 200-800	740E	102		15	10	
800017N	John Deere	Minibagger / 200-800	740G	102		15	10	
800015N	John Deere	Minibagger / 200-800	855	102				
800017N	John Deere	Motorgrader / 400-800	670	102		15	10	
800017N	John Deere	Motorgrader / 400-800	670B	102		15	10	
800017N	John Deere	Motorgrader / 400-800	670H	102		15	10	
800017N	John Deere	Motorgrader / 400-800	672	102		15	10	
800017N	John Deere	Motorgrader / 400-800	672B	102		15	10	
800017N	John Deere	Motorgrader / 400-800	672H	102		15	10	
800017N	John Deere	Motorgrader / 400-800	770	102		15	10	
800017N	John Deere	Motorgrader / 400-800	770B	102		15	10	
800017N	John Deere	Motorgrader / 400-800	770BH	102		15	10	
800017N	John Deere	Motorgrader / 400-800	772	102		15	10	
800017N	John Deere	Motorgrader / 400-800	772B	102		15	10	
800017N	John Deere	Motorgrader / 400-800	772BH	102		15	10	
800017N	John Deere	Motorgrader / 400-800	870	102		15	10	
800017N	John Deere	Muldenkipper / 200-700	748E	102		15	10	
800017N	John Deere	Raupen Dozer / 400-850	450H	102		15	10	
800017N	John Deere	Raupen Dozer / 400-850	550H	102		15	10	
800017N	John Deere	Raupen Dozer / 400-850	650H	102		15	10	
800015N	John Deere	Raupen Dozer / 400-850	655	102				
800015N	John Deere	Raupen Dozer / 400-850	655B	102				

Dasis Nr.	Hersteller	Modell	Typ	Außendurchmesser [mm]	Länge [mm]	Innengewinde 1 [mm]	Außengewinde 1 [mm]	für OE-Nummer
800017N	John Deere	Raupen Dozer / 400-850	700H	102		15	10	
800017N	John Deere	Raupen Dozer / 400-850	710	102		15	10	
800015N	John Deere	Raupen Dozer / 400-850	750	102				
800017N	John Deere	Raupen Dozer / 400-850	750	102		15	10	
800015N	John Deere	Raupen Dozer / 400-850	750B	102				
800017N	John Deere	Raupen Dozer / 400-850	750J	102		15	10	
800015N	John Deere	Raupen Dozer / 400-850	755	102				
800015N	John Deere	Raupen Dozer / 400-850	755B	102				
800015N	John Deere	Raupen Dozer / 400-850	850	102				
800017N	John Deere	Raupen Dozer / 400-850	850	102		15	10	
800015N	John Deere	Raupen Dozer / 400-850	850B	102				
800017N	John Deere	Raupen Dozer / 400-850	850J	102		15	10	
800017N	John Deere	Schaufellader / 400-800 Serie	444J	102		15	10	
800017N	John Deere	Schaufellader / 400-800 Serie	544G	102		15	10	
800015N	John Deere	Schaufellader / 400-800 Serie	4890	102				
800015N	John Deere	Schaufellader / 400-800 Serie	4895	102				
800015N	John Deere	Schaufellader / 400-800 Serie	4990	102				
800015N	John Deere	Schaufellader / 400-800 Serie	4995	102				
800017N	John Deere	Schaufellader / 400-800 Serie	T44H	102		15	10	
800017N	John Deere	Schaufellader / 400-800 Serie	T54H	102		15	10	
800015N	John Deere	Schlepper / 300-955	830	102				
800015N	John Deere	Schlepper / 300-955	840	102				
800015N	John Deere	Schlepper / 300-955	930	102				
800015N	John Deere	Schlepper / 300-955	940	102				
800015N	John Deere	Schlepper / 1000-1950	1030	102				
800015N	John Deere	Schlepper / 1000-1950	1040	102				
800015N	John Deere	Schlepper / 1000-1950	1130	102				
800015N	John Deere	Schlepper / 1000-1950	1140	102				

Dasis Nr.	Hersteller	Modell	Typ	Außendurchmesser [mm]	Länge [mm]	Innengewinde 1 [mm]	Außengewinde 1 [mm]	für OE-Nummer
800015N	John Deere	Schlepper / 1000-1950	1350	102				
800015N	John Deere	Schlepper / 1000-1950	1530	102				
800015N	John Deere	Schlepper / 1000-1950	1550	102				
800015N	John Deere	Schlepper / 1000-1950	1630	102				
800015N	John Deere	Schlepper / 1000-1950	1640	102				
800015N	John Deere	Schlepper / 1000-1950	1750	102				
800015N	John Deere	Schlepper / 1000-1950	1830	102				
800015N	John Deere	Schlepper / 1000-1950	1840	102				
800015N	John Deere	Schlepper / 1000-1950	1850	102				
800015N	John Deere	Schlepper / 1000-1950	1950	102				
800015N	John Deere	Schlepper / 2000-2955	2030	102				
800015N	John Deere	Schlepper / 2000-2955	2040	102				
800015N	John Deere	Schlepper / 2000-2955	2040S	102				
800015N	John Deere	Schlepper / 2000-2955	2130	102				
800015N	John Deere	Schlepper / 2000-2955	2140	102				
800015N	John Deere	Schlepper / 2000-2955	2240	102				
800015N	John Deere	Schlepper / 2000-2955	2250	102				
800015N	John Deere	Schlepper / 2000-2955	2450	102				
800015N	John Deere	Schlepper / 2000-2955	2550	102				
800015N	John Deere	Schlepper / 2000-2955	2650	102				
800015N	John Deere	Schlepper / 2000-2955	2850	102				
800015N	John Deere	Schlepper / 3000-3650	3030	102				
800015N	John Deere	Schlepper / 3000-3650	3040	102				
800015N	John Deere	Schlepper / 3000-3650	3050	102				
800015N	John Deere	Schlepper / 3000-3650	3130	102				
800015N	John Deere	Schlepper / 3000-3650	3140	102				
800015N	John Deere	Schlepper / 3000-3650	3150	102				
800015N	John Deere	Schlepper / 3000-3650	3340	102				
800015N	John Deere	Schlepper / 3000-3650	3350	102				
800015N	John Deere	Schlepper / 3000-3650	3640	102				
800015N	John Deere	Schlepper / 3000-3650	3650	102				

Dasis Nr.	Hersteller	Modell	Typ	Außendurchmesser [mm]	Länge [mm]	Innengewinde 1 [mm]	Außengewinde 1 [mm]	für OE-Nummer
800015N	John Deere	Schlepper / 4000-4955	4040	102				
800015N	John Deere	Schlepper / 4000-4955	4040S	102				
800015N	John Deere	Schlepper / 4000-4955	4050	102				
800015N	John Deere	Schlepper / 4000-4955	4055	102				
800015N	John Deere	Schlepper / 4000-4955	4230	102				
800015N	John Deere	Schlepper / 4000-4955	4240	102				
800015N	John Deere	Schlepper / 4000-4955	4240S	102				
800015N	John Deere	Schlepper / 4000-4955	4250	102				
800015N	John Deere	Schlepper / 4000-4955	4255	102				
800015N	John Deere	Schlepper / 4000-4955	4350	102				
800015N	John Deere	Schlepper / 4000-4955	4430	102				
800015N	John Deere	Schlepper / 4000-4955	4440	102				
800015N	John Deere	Schlepper / 4000-4955	4450	102				
800015N	John Deere	Schlepper / 4000-4955	4455	102				
800015N	John Deere	Schlepper / 4000-4955	4555	102				
800015N	John Deere	Schlepper / 4000-4955	4630	102				
800015N	John Deere	Schlepper / 4000-4955	4640	102				
800015N	John Deere	Schlepper / 4000-4955	4650	102				
800015N	John Deere	Schlepper / 4000-4955	4755	102				
800015N	John Deere	Schlepper / 4000-4955	4840	102				
800015N	John Deere	Schlepper / 4000-4955	4850	102				
800015N	John Deere	Schlepper / 4000-4955	4955	102				
805002N	John Deere	Schlepper / 5000-5820	5055E	64	156	10		AL204865 AL220728
805002N	John Deere	Schlepper / 5000-5820	5065	64	156	10		AL204865 AL220728
805002N	John Deere	Schlepper / 5000-5820	5065M	64	156	10		AL204865 AL220728
805002N	John Deere	Schlepper / 5000-5820	5075E	64	156	10		AL204865 AL220728
805002N	John Deere	Schlepper / 5000-5820	5075M	64	156	10		AL204865 AL220728
800015N	John Deere	Schlepper / 5000-5820	5200	102				
800015N	John Deere	Schlepper / 5000-5820	5220	102				
800015N	John Deere	Schlepper / 5000-5820	5300	102				
800015N	John Deere	Schlepper / 5000-5820	5310	102				



Dasis Nr.	Hersteller	Modell	Typ	Außendurchmesser [mm]	Länge [mm]	Innengewinde 1 [mm]	Außengewinde 1 [mm]	für OE-Nummer
800015N	John Deere	Schlepper / 5000-5820	5320	102				
800015N	John Deere	Schlepper / 5000-5820	5400	102				
800015N	John Deere	Schlepper / 5000-5820	5410	102				
800015N	John Deere	Schlepper / 5000-5820	5420	102				
800015N	John Deere	Schlepper / 5000-5820	5500	102				
800015N	John Deere	Schlepper / 5000-5820	5510	102				
800015N	John Deere	Schlepper / 5000-5820	5520	102				
800533N	John Deere	Schlepper / 5000-5820	5620	102		9	10	
800533N	John Deere	Schlepper / 5000-5820	5720	102		9	10	
800533N	John Deere	Schlepper / 5000-5820	5820	102		9	10	
800015N	John Deere	Schlepper / 6000-6930	6010	102				
800562N	John Deere	Schlepper / 6000-6930	6020	76		8,5	10	
800533N	John Deere	Schlepper / 6000-6930	6020	102		9	10	
800015N	John Deere	Schlepper / 6000-6930	6100	102				
805002N	John Deere	Schlepper / 6000-6930	6100	64	156	10		AL204865 AL220728
805002N	John Deere	Schlepper / 6000-6930	6105D	64	156	10		AL204865 AL220728
800678N	John Deere	Schlepper / 6000-6930	6105M					AL211626 AL220729
805002N	John Deere	Schlepper / 6000-6930	6105M	64	156	10		AL204865 AL220728
805002N	John Deere	Schlepper / 6000-6930	6105R	64	156	10		AL204865 AL220728
800015N	John Deere	Schlepper / 6000-6930	6110	102				
800678N	John Deere	Schlepper / 6000-6930	6110M					AL211626 AL220729
800678N	John Deere	Schlepper / 6000-6930	6110R					AL211626 AL220729
805002N	John Deere	Schlepper / 6000-6930	6110R	64	156	10		AL204865 AL220728
800678N	John Deere	Schlepper / 6000-6930	6115M					AL211626 AL220729
805002N	John Deere	Schlepper / 6000-6930	6115M	64	156	10		AL204865 AL220728
805002N	John Deere	Schlepper / 6000-6930	6115R	64	156	10		AL204865 AL220728
800562N	John Deere	Schlepper / 6000-6930	6120	76		8,5	10	
800015N	John Deere	Schlepper / 6000-6930	6120	102				
800533N	John Deere	Schlepper / 6000-6930	6120	102		9	10	
800678N	John Deere	Schlepper / 6000-6930	6120M					AL211626 AL220729
805002N	John Deere	Schlepper / 6000-6930	6120M	64	156	10		AL204865 AL220728

Dasis Nr.	Hersteller	Modell	Typ	Außendurchmesser [mm]	Länge [mm]	Innengewinde 1 [mm]	Außengewinde 1 [mm]	für OE-Nummer
800678N	John Deere	Schlepper / 6000-6930	6120R					AL211626 AL220729
800678N	John Deere	Schlepper / 6000-6930	6125M					AL211626 AL220729
805002N	John Deere	Schlepper / 6000-6930	6125R	64	156	10		AL204865 AL220728
800678N	John Deere	Schlepper / 6000-6930	6130M					AL211626 AL220729
800678N	John Deere	Schlepper / 6000-6930	6130R					AL211626 AL220729
800678N	John Deere	Schlepper / 6000-6930	6135M					AL211626 AL220729
805002N	John Deere	Schlepper / 6000-6930	6135M	64	156	10		AL204865 AL220728
800678N	John Deere	Schlepper / 6000-6930	6135R					AL211626 AL220729
805002N	John Deere	Schlepper / 6000-6930	6140D	64	156	10		AL204865 AL220728
800678N	John Deere	Schlepper / 6000-6930	6140M					AL211626 AL220729
805002N	John Deere	Schlepper / 6000-6930	6140M	64	156	10		AL204865 AL220728
800678N	John Deere	Schlepper / 6000-6930	6140R					AL211626 AL220729
800678N	John Deere	Schlepper / 6000-6930	6145M					AL211626 AL220729
800678N	John Deere	Schlepper / 6000-6930	6145R					AL211626 AL220729
805002N	John Deere	Schlepper / 6000-6930	6145R	64	156	10		AL204865 AL220728
800678N	John Deere	Schlepper / 6000-6930	6150M					AL211626 AL220729
800678N	John Deere	Schlepper / 6000-6930	6150R					AL211626 AL220729
800678N	John Deere	Schlepper / 6000-6930	6155M					AL211626 AL220729
800678N	John Deere	Schlepper / 6000-6930	6155R					AL211626 AL220729
800678N	John Deere	Schlepper / 6000-6930	6170M					AL211626 AL220729
800678N	John Deere	Schlepper / 6000-6930	6170R					AL211626 AL220729
800678N	John Deere	Schlepper / 6000-6930	6175M					AL211626 AL220729
800678N	John Deere	Schlepper / 6000-6930	6175R					AL211626 AL220729
800678N	John Deere	Schlepper / 6000-6930	6190R					AL211626 AL220729
805002N	John Deere	Schlepper / 6000-6930	6190R	64	156	10		AL204865 AL220728
800678N	John Deere	Schlepper / 6000-6930	6195M					AL211626 AL220729
800678N	John Deere	Schlepper / 6000-6930	6195R					AL211626 AL220729
800015N	John Deere	Schlepper / 6000-6930	6200	102				
800015N	John Deere	Schlepper / 6000-6930	6210	102				
800678N	John Deere	Schlepper / 6000-6930	6210R					AL211626 AL220729
800678N	John Deere	Schlepper / 6000-6930	6215R					AL211626 AL220729

Dasis Nr.	Hersteller	Modell	Typ	Außendurchmesser [mm]	Länge [mm]	Innengewinde 1 [mm]	Außengewinde 1 [mm]	für OE-Nummer
800562N	John Deere	Schlepper / 6000-6930	6220	76		8,5	10	
800533N	John Deere	Schlepper / 6000-6930	6220	102		9	10	
800678N	John Deere	Schlepper / 6000-6930	6230R					AL211626 AL220729
800678N	John Deere	Schlepper / 6000-6930	6250R					AL211626 AL220729
800015N	John Deere	Schlepper / 6000-6930	6300	102				
800015N	John Deere	Schlepper / 6000-6930	6310	102				
800562N	John Deere	Schlepper / 6000-6930	6320	76		8,5	10	
800533N	John Deere	Schlepper / 6000-6930	6320	102		9	10	
800015N	John Deere	Schlepper / 6000-6930	6400	102				
800015N	John Deere	Schlepper / 6000-6930	6410	102				
800562N	John Deere	Schlepper / 6000-6930	6420	76		8,5	10	
800533N	John Deere	Schlepper / 6000-6930	6420	102		9	10	
800562N	John Deere	Schlepper / 6000-6930	6420S	76		8,5	10	
800533N	John Deere	Schlepper / 6000-6930	6420S	102		9	10	
800015N	John Deere	Schlepper / 6000-6930	6506	102				
800015N	John Deere	Schlepper / 6000-6930	6510	102				
800562N	John Deere	Schlepper / 6000-6930	6520	76		8,5	10	
800533N	John Deere	Schlepper / 6000-6930	6520	102		9	10	
800015N	John Deere	Schlepper / 6000-6930	6600	102				
800015N	John Deere	Schlepper / 6000-6930	6610	102				
800562N	John Deere	Schlepper / 6000-6930	6620	76		8,5	10	
800533N	John Deere	Schlepper / 6000-6930	6620	102		9	10	
800015N	John Deere	Schlepper / 6000-6930	6800	102				
800015N	John Deere	Schlepper / 6000-6930	6810	102				
800562N	John Deere	Schlepper / 6000-6930	6820	76		8,5	10	
800533N	John Deere	Schlepper / 6000-6930	6820	102		9	10	
800015N	John Deere	Schlepper / 6000-6930	6900	102				
800015N	John Deere	Schlepper / 6000-6930	6910	102				
800015N	John Deere	Schlepper / 6000-6930	6910S	102				
800562N	John Deere	Schlepper / 6000-6930	6920	76		8,5	10	
800533N	John Deere	Schlepper / 6000-6930	6920	102		9	10	

Dasis Nr.	Hersteller	Modell	Typ	Außendurchmesser [mm]	Länge [mm]	Innengewinde 1 [mm]	Außengewinde 1 [mm]	für OE-Nummer
800562N	John Deere	Schlepper / 6000-6930	6920S	76		8,5	10	
800533N	John Deere	Schlepper / 6000-6930	6920S	102		9	10	
800015N	John Deere	Schlepper / 7000-7920	7600	102				
800015N	John Deere	Schlepper / 7000-7920	7610	102				
800015N	John Deere	Schlepper / 7000-7920	7700	102				
800015N	John Deere	Schlepper / 7000-7920	7710	102				
800552N	John Deere	Schlepper / 7000-7920	7720	76		8	10	
800015N	John Deere	Schlepper / 7000-7920	7800	102				
800015N	John Deere	Schlepper / 7000-7920	7810	102				
800552N	John Deere	Schlepper / 7000-7920	7820	76		8	10	
800552N	John Deere	Schlepper / 7000-7920	7920	76		8	10	
800017N	John Deere	Schlepper / 8000-8640	8100	102		15	10	
800017N	John Deere	Schlepper / 8000-8640	8110	102		15	10	
800552N	John Deere	Schlepper / 8000-8640	8120	76		8	10	
800552N	John Deere	Schlepper / 8000-8640	8130	76		8	10	
800017N	John Deere	Schlepper / 8000-8640	8200	102		15	10	
800017N	John Deere	Schlepper / 8000-8640	8210	102		15	10	
800552N	John Deere	Schlepper / 8000-8640	8220	76		8	10	
800552N	John Deere	Schlepper / 8000-8640	8230	76		8	10	
800017N	John Deere	Schlepper / 8000-8640	8300	102		15	10	
800017N	John Deere	Schlepper / 8000-8640	8310	102		15	10	
800552N	John Deere	Schlepper / 8000-8640	8320	76		8	10	
800552N	John Deere	Schlepper / 8000-8640	8330	76		8	10	
800017N	John Deere	Schlepper / 8000-8640	8400	102		15	10	
800017N	John Deere	Schlepper / 8000-8640	8410	102		15	10	
800015N	John Deere	Schlepper / 8000-8640	8430	102				
800015N	John Deere	Schlepper / 8000-8640	8440	102				
800552N	John Deere	Schlepper / 8000-8640	8520	76		8	10	
800552N	John Deere	Schlepper / 8000-8640	8530	76		8	10	
800555N	John Deere	Schlepper / 8000-8640	8570	89		25	11	
800015N	John Deere	Schlepper / 8000-8640	8640	102				

Dasis Nr.	Hersteller	Modell	Typ	Außendurchmesser [mm]	Länge [mm]	Innengewinde 1 [mm]	Außengewinde 1 [mm]	für OE-Nummer
800015N	John Deere	Schlepper / 9000-9620	9100	102				
800015N	John Deere	Schlepper / 9000-9620	9200	102				
800015N	John Deere	Schlepper / 9000-9620	9300	102				
800015N	John Deere	Schlepper / 9000-9620	9400	102				
800017N	John Deere	Schlepper / CTS	CTS II	102		15	10	
800064N	John Deere	Schlepper Wein Obst / 5000N-9620	5215F	76			16	
800064N	John Deere	Schlepper Wein Obst / 5000N-9620	5215V	76			16	
800064N	John Deere	Schlepper Wein Obst / 5000N-9620	5300	76			16	
800064N	John Deere	Schlepper Wein Obst / 5000N-9620	5310	76			16	
800064N	John Deere	Schlepper Wein Obst / 5000N-9620	5315F	76			16	
800064N	John Deere	Schlepper Wein Obst / 5000N-9620	5315V	76			16	
800064N	John Deere	Schlepper Wein Obst / 5000N-9620	5400	76			16	
800064N	John Deere	Schlepper Wein Obst / 5000N-9620	5410	76			16	
800064N	John Deere	Schlepper Wein Obst / 5000N-9620	5500	76			16	
800015N	John Deere	Schlepper Wein Obst / 5000N-9620	9120	102				
800015N	John Deere	Schlepper Wein Obst / 5000N-9620	9220	102				
800015N	John Deere	Schlepper Wein Obst / 5000N-9620	9320	102				
800015N	John Deere	Schlepper Wein Obst / 5000N-9620	9420	102				
800015N	John Deere	Schlepper Wein Obst / 5000N-9620	9520	102				
800015N	John Deere	Schlepper Wein Obst / 5000N-9620	9620	102				
800017N	John Deere	Schürfzüge / 800	872	102		15	10	
800017N	John Deere	Selbstfahrende Feldspritze	4700	102		15	10	
800552N	John Deere	Selbstfahrende Feldspritze	4710	76		8	10	
800017N	John Deere	Selbstfahrende Feldspritze	4710	102		15	10	
800552N	John Deere	Selbstfahrende Feldspritze	4920	76		8	10	

Dasis Nr.	Hersteller	Modell	Typ	Außendurchmesser [mm]	Länge [mm]	Innengewinde 1 [mm]	Außengewinde 1 [mm]	für OE-Nummer
800017N	John Deere	Selbstfahrende Feldspritze	4920	102		15	10	
800552N	John Deere	Selbstfahrende Feldspritze	4930	76		8	10	
800017N	John Deere	Selbstfahrende Feldspritze	4930	102		15	10	
800178N	John Deere	Selbstfahrende Feldspritze	5440	102		9	15	
800015N	John Deere	Selbstfahrende Feldspritze	6000	102				
800015N	John Deere	Selbstfahrende Feldspritze	6100	102				
800015N	John Deere	Selbstfahrende Feldspritze	6500	102				
800015N	John Deere	Selbstfahrende Feldspritze	6600	102				
800015N	John Deere	Selbstfahrende Feldspritze	6700	102				
800178N	John Deere	Selbstfahrende Feldspritze	7200	102		9	15	
800178N	John Deere	Selbstfahrende Feldspritze	7300	102		9	15	
800178N	John Deere	Selbstfahrende Feldspritze	7400	102		9	15	
800178N	John Deere	Selbstfahrende Feldspritze	7500	102		9	15	
800178N	John Deere	Selbstfahrende Feldspritze	7700	102		9	15	
800178N	John Deere	Selbstfahrende Feldspritze	7800	102		9	15	
800540N	John Deere	Selbstfahrende Schwadmäher / 2200-6670	2250	102				
800540N	John Deere	Selbstfahrende Schwadmäher / 2200-6670	2270	102				
800017N	John Deere	Selbstfahrende Schwadmäher / 2200-6670	2280	102		15	10	
800017N	John Deere	Selbstfahrende Schwadmäher / 2200-6670	2320	102		15	10	
800017N	John Deere	Selbstfahrende Schwadmäher / 2200-6670	2420	102		15	10	
800015N	John Deere	Selbstfahrende Schwadmäher / 2200-6670	3430	102				
800017N	John Deere	Selbstfahrende Schwadmäher / 2200-6670	3430	102		15	10	
800015N	John Deere	Selbstfahrende Schwadmäher / 2200-6670	3830	102				
800017N	John Deere	Selbstfahrende Schwadmäher / 2200-6670	3830	102		15	10	
800015N	John Deere	Selbstfahrende Schwadmäher / 2200-6670	6670	102				
800015N	John Deere	Teleskoplader / 3200-3400	3200	102				
800015N	John Deere	Teleskoplader / 3200-3400	3215	102				

Dasis Nr.	Hersteller	Modell	Typ	Außendurchmesser [mm]	Länge [mm]	Innengewinde 1 [mm]	Außengewinde 1 [mm]	für OE-Nummer
800015N	John Deere	Teleskoplader / 3200-3400	3220	102				
800962N	Kioti	Traktor DK	45	63				
800962N	Kioti	Traktor DK	50	63				
800962N	Kioti	Traktor DK	55	63				
800962N	Kioti	Traktor DK	65	63				
800962N	Kioti	Traktor DK	75	63				
800962N	Kioti	Traktor DK	90	63				
800962N	Kioti	Traktor DK	7510	63				
800962N	Kioti	Traktor DK	9010	63				
800553N	Komatsu	Bagger 360 Grad / PC	60-1000	70		9	10	
800393N	Komatsu	Muldenkipper / 65	65	61		10		
800393N	Komatsu	Raupen Dozer / D	41E	61		10		
800051N	Komatsu	Raupen Dozer / D	155-1					
800051N	Komatsu	Raupen Dozer / D	355A-3					
800386N	Komatsu	Raupen Dozer / PC	300-6	76				
800553N	Komatsu	Schaufellader / WA	350-650	70		9	10	
800551N	Komatsu	Schlepper	SonstigeModelle					
802590N	Komatsu	Schlepper	SonstigeModelle	76			10	
800536N	Komatsu	Schlepper	SonstigeModelle	89		9		
800015N	Komatsu	Schlepper	SonstigeModelle	102				
800201N	Krone	Mähdrescher BIG M	BIGM	76			10	
800372N	Lamborghini	Schlepper / Agile RS/RV	70	76				
800372N	Lamborghini	Schlepper / Agile RS/RV	75	76				
800372N	Lamborghini	Schlepper / Agile RS/RV	90	76				
800372N	Lamborghini	Schlepper / Agile RS/RV	100	76				
800372N	Lamborghini	Schlepper / Agile RS/RV	660F	76				
800372N	Lamborghini	Schlepper / Agile RS/RV	770F	76				
800372N	Lamborghini	Schlepper / Agile RS/RV	880F	76				
800372N	Lamborghini	Schlepper / Agile RS/RV	980F	76				
800544N	Lamborghini	Schlepper / Champion	135	65		13	15	
800544N	Landini	Mähdrescher / Rex	75V	65		13	15	

Dasis Nr.	Hersteller	Modell	Typ	Außendurchmesser [mm]	Länge [mm]	Innengewinde 1 [mm]	Außengewinde 1 [mm]	für OE-Nummer
800544N	Landini	Mähdrescher / Rex	85V	65		13	15	
800544N	Landini	Mähdrescher / Rex	90GT	65		13	15	
800544N	Landini	Mähdrescher / Rex	95F	65		13	15	
800544N	Landini	Schlepper / Globus	50	65		13	15	
800544N	Landini	Schlepper / Globus	55	65		13	15	
800544N	Landini	Schlepper / Globus	60	65		13	15	
800544N	Landini	Schlepper / Globus	65	65		13	15	
800544N	Landini	Schlepper / Globus	70	65		13	15	
800544N	Landini	Schlepper / Globus	75	65		13	15	
800544N	Landini	Schlepper / Globus	80	65		13	15	
800154N	Landini	Schlepper / Legend	105	62				
800154N	Landini	Schlepper / Legend	115	62				
800154N	Landini	Schlepper / Legend	130	62				
800154N	Landini	Schlepper / Legend	145	62				
800154N	Landini	Schlepper / Legend	165	62				
800010N	Landini	Schlepper / Mythos	90	76		14,7	15,8	
800010N	Landini	Schlepper / Mythos	100	76		14,7	15,8	
800010N	Landini	Schlepper / Mythos	110	76		14,7	15,8	
800010N	Landini	Schlepper / Mythos	115	76		14,7	15,8	
800152N	Landini	Schlepper / NewLegend	115	80			15	
800152N	Landini	Schlepper / NewLegend	120	80			15	
800561N	Landini	Schlepper / NewLegend	125	45				
800152N	Landini	Schlepper / NewLegend	130	80			15	
800561N	Landini	Schlepper / NewLegend	135	45				
800154N	Landini	Schlepper / NewLegend	140	62				
800561N	Landini	Schlepper / NewLegend	145	45				
800154N	Landini	Schlepper / NewLegend	160	62				
800154N	Landini	Schlepper / NewLegend	180	62				
800561N	Landini	Schlepper / NewLegend Räder 2	125	45				
800561N	Landini	Schlepper / NewLegend Räder 2	135	45				



Dasis Nr.	Hersteller	Modell	Typ	Außendurchmesser [mm]	Länge [mm]	Innengewinde 1 [mm]	Außengewinde 1 [mm]	für OE-Nummer
800561N	Landini	Schlepper / NewLegend Räder 2	145	45				
800154N	Landini	Schlepper / NewLegend Räder 2	165	62				
800154N	Landini	Schlepper / NewLegend Räder 2	185	62				
800544N	Landini	Schlepper / Power Farm	95	65		13	15	
800544N	Landini	Schlepper / Power Farm	105	65		13	15	
800544N	Landini	Schlepper / Vision New Räder 2	85	65		13	15	
800544N	Landini	Schlepper / Vision New Räder 2	95	65		13	15	
800544N	Landini	Schlepper / Vision New Räder 2	105	65		13	15	
800173N	Liebherr	Liebherr Bagger 360 ° / 500	554	102			10	
800173N	Liebherr	Liebherr Bagger 360 ° / 500	564	102			10	
800173N	Liebherr	Liebherr Bagger 360 ° / 900	914	102			10	
800173N	Liebherr	Liebherr Bagger 360 ° / 900	954	102			10	
800173N	Liebherr	Schlepper	SonstigeModelle	102			10	
800558N	Manitou	Teleskoplader / MLT/MLA	523S1	50				
800558N	Manitou	Teleskoplader / MLT/MLA	523S2-	50				
800558N	Manitou	Teleskoplader / MLT/MLA	523TS1	50				
800558N	Manitou	Teleskoplader / MLT/MLA	523TS2	50				
800558N	Manitou	Teleskoplader / MLT/MLA	524S1	50				
800558N	Manitou	Teleskoplader / MLT/MLA	524TS1	50				
800558N	Manitou	Teleskoplader / MLT/MLA	526A	50				
800558N	Manitou	Teleskoplader / MLT/MLA	526S1	50				
800558N	Manitou	Teleskoplader / MLT/MLA	526S2	50				
800558N	Manitou	Teleskoplader / MLT/MLA	526TA	50				
800558N	Manitou	Teleskoplader / MLT/MLA	526TACompact	50				
800558N	Manitou	Teleskoplader / MLT/MLA	526TS1	50				
800558N	Manitou	Teleskoplader / MLT/MLA	526TS2	50				
800558N	Manitou	Teleskoplader / MLT/MLA	527S1	50				
800558N	Manitou	Teleskoplader / MLT/MLA	527TS1	50				
800558N	Manitou	Teleskoplader / MLT/MLA	626S2	50				

Dasis Nr.	Hersteller	Modell	Typ	Außendurchmesser [mm]	Länge [mm]	Innengewinde 1 [mm]	Außengewinde 1 [mm]	für OE-Nummer
800558N	Manitou	Teleskoplader / MLT/MLA	626S3	50				
800558N	Manitou	Teleskoplader / MLT/MLA	626TS2	50				
800558N	Manitou	Teleskoplader / MLT/MLA	626TS3	50				
800558N	Manitou	Teleskoplader / MLT/MLA	627S1	50				
800558N	Manitou	Teleskoplader / MLT/MLA	628-120S3-E2PSLS	50				
800558N	Manitou	Teleskoplader / MLT/MLA	628S1	50				
800558N	Manitou	Teleskoplader / MLT/MLA	628TS1	50				
800558N	Manitou	Teleskoplader / MLT/MLA	628TS2PS	50				
800558N	Manitou	Teleskoplader / MLT/MLA	628TS2PSLS	50				
800558N	Manitou	Teleskoplader / MLT/MLA	628TS3-E2PS	50				
800558N	Manitou	Teleskoplader / MLT/MLA	629-120ALS	50				
800558N	Manitou	Teleskoplader / MLT/MLA	629A	50				
800558N	Manitou	Teleskoplader / MLT/MLA	629S1	50				
800558N	Manitou	Teleskoplader / MLT/MLA	629TA	50				
800558N	Manitou	Teleskoplader / MLT/MLA	629TS1	50				
800558N	Manitou	Teleskoplader / MLT/MLA	630-120B-E2LS	50				
800558N	Manitou	Teleskoplader / MLT/MLA	630S3	50				
800558N	Manitou	Teleskoplader / MLT/MLA	630TB-E2	50				
800558N	Manitou	Teleskoplader / MLT/MLA	630TS3	50				
800558N	Manitou	Teleskoplader / MLT/MLA	632S1	50				
800558N	Manitou	Teleskoplader / MLT/MLA	632TS1	50				
800558N	Manitou	Teleskoplader / MLT/MLA	633-120APSLs	50				
800558N	Manitou	Teleskoplader / MLT/MLA	633-120S1LS	50				
800558N	Manitou	Teleskoplader / MLT/MLA	633-120S1PSLS	50				
800558N	Manitou	Teleskoplader / MLT/MLA	633TALS	50				
800558N	Manitou	Teleskoplader / MLT/MLA	633TS1LS	50				
800558N	Manitou	Teleskoplader / MLT/MLA	633TS1PS	50				
800558N	Manitou	Teleskoplader / MLT/MLA	634-120B-E2LS	50				
800558N	Manitou	Teleskoplader / MLT/MLA	634-120B-E2PSLS	50				
800558N	Manitou	Teleskoplader / MLT/MLA	634TB-E2LS	50				
800558N	Manitou	Teleskoplader / MLT/MLA	725S2	50				

Dasis Nr.	Hersteller	Modell	Typ	Außendurchmesser [mm]	Länge [mm]	Innengewinde 1 [mm]	Außengewinde 1 [mm]	für OE-Nummer
800558N	Manitou	Teleskoplader / MLT/MLA	725S3	50				
800558N	Manitou	Teleskoplader / MLT/MLA	725TS2	50				
800558N	Manitou	Teleskoplader / MLT/MLA	725TS3	50				
800558N	Manitou	Teleskoplader / MLT/MLA	728S1	50				
800558N	Manitou	Teleskoplader / MLT/MLA	728TS1	50				
800558N	Manitou	Teleskoplader / MLT/MLA	730-120ALS	50				
800558N	Manitou	Teleskoplader / MLT/MLA	730-120APSLs	50				
800558N	Manitou	Teleskoplader / MLT/MLA	730-120S1LS	50				
800558N	Manitou	Teleskoplader / MLT/MLA	730-120S1PSLS	50				
800558N	Manitou	Teleskoplader / MLT/MLA	730A	50				
800558N	Manitou	Teleskoplader / MLT/MLA	730S1	50				
800558N	Manitou	Teleskoplader / MLT/MLA	730TA	50				
800558N	Manitou	Teleskoplader / MLT/MLA	730TALS	50				
800558N	Manitou	Teleskoplader / MLT/MLA	730TS1	50				
800558N	Manitou	Teleskoplader / MLT/MLA	730TS1LS	50				
800558N	Manitou	Teleskoplader / MLT/MLA	731TB-E2	50				
800558N	Manitou	Teleskoplader / MLT/MLA	731TB-E2LS	50				
800558N	Manitou	Teleskoplader / MLT/MLA	740TS1HLS	50				
800558N	Manitou	Teleskoplader / MLT/MLA	741-120S2-E2LS	50				
800558N	Manitou	Teleskoplader / MLT/MLA	741-120S2-E2PSLS	50				
800558N	Manitou	Teleskoplader / MLT/MLA	742TS2-E2	50				
800558N	Manitou	Teleskoplader / MLT/MLA	742TS2-E2HLS	50				
800224N	Massey Ferguson	Mähdrescher / 10-900	400	63,5				
800224N	Massey Ferguson	Mähdrescher / 10-900	500	63,5				
800224N	Massey Ferguson	Mähdrescher / 10-900	510	63,5				
800224N	Massey Ferguson	Mähdrescher / 10-900	515	63,5				
800049N	Massey Ferguson	Mähdrescher / 10-900	740	76			16	
800049N	Massey Ferguson	Mähdrescher / 10-900	750	76			16	
800049N	Massey Ferguson	Mähdrescher / 10-900	760	76			16	
800056N	Massey Ferguson	Mähdrescher / 10-900	800	102			21	
800056N	Massey Ferguson	Mähdrescher / 10-900	805	102			21	

Dasis Nr.	Hersteller	Modell	Typ	Außendurchmesser [mm]	Länge [mm]	Innengewinde 1 [mm]	Außengewinde 1 [mm]	für OE-Nummer
800056N	Massey Ferguson	Mähdrescher / 10-900	810	102			21	
800056N	Massey Ferguson	Mähdrescher / 10-900	815	102			21	
800056N	Massey Ferguson	Mähdrescher / 10-900	820	102			21	
800056N	Massey Ferguson	Mähdrescher / 10-900	830	102			21	
800056N	Massey Ferguson	Mähdrescher / 10-900	835	102			21	
800056N	Massey Ferguson	Mähdrescher / 10-900	840	102			21	
800056N	Massey Ferguson	Mähdrescher / 10-900	845	102			21	
800056N	Massey Ferguson	Mähdrescher / 10-900	850	102			21	
800056N	Massey Ferguson	Mähdrescher / 10-900	860	102			21	
800056N	Massey Ferguson	Mähdrescher / 10-900	865	102			21	
800372N	Massey Ferguson	Mähdrescher / 3400-9790	3425V	76				
800372N	Massey Ferguson	Mähdrescher / 3400-9790	3435V	76				
800372N	Massey Ferguson	Mähdrescher / 3400-9790	3445V	76				
800372N	Massey Ferguson	Mähdrescher / 3400-9790	3455V	76				
800064N	Massey Ferguson	Mähdrescher / 3400-9790	7244	76			16	
800064N	Massey Ferguson	Mähdrescher / 3400-9790	7250	76			16	
800064N	Massey Ferguson	Mähdrescher / 3400-9790	7252	76			16	
800064N	Massey Ferguson	Mähdrescher / 3400-9790	7254	76			16	
800064N	Massey Ferguson	Mähdrescher / 3400-9790	7256	76			16	
800064N	Massey Ferguson	Mähdrescher / 3400-9790	7272	76			16	
800064N	Massey Ferguson	Mähdrescher / 3400-9790	7274	76			16	
800064N	Massey Ferguson	Mähdrescher / 3400-9790	7276	76			16	
800064N	Massey Ferguson	Mähdrescher / 3400-9790	7278	76			16	
800397N	Massey Ferguson	Mähdrescher / 3400-9790	8450	70				
800397N	Massey Ferguson	Mähdrescher / 3400-9790	8460	70				
800386N	Massey Ferguson	Mähdrescher / 3400-9790	8570	76				
800386N	Massey Ferguson	Mähdrescher / 3400-9790	8590	76				
800386N	Massey Ferguson	Mähdrescher / 3400-9790	8680	76				
800532N	Massey Ferguson	Mähdrescher / 3400-9790	8780	76				
802300N	Massey Ferguson	Mähdrescher / 3400-9790	8780	76				
800535N	Massey Ferguson	Mähdrescher / 3400-9790	9690	70			15	

Dasis Nr.	Hersteller	Modell	Typ	Außendurchmesser [mm]	Länge [mm]	Innengewinde 1 [mm]	Außengewinde 1 [mm]	für OE-Nummer
800373N	Massey Ferguson	Mähdrescher / 3400-9790	9720	76				
800535N	Massey Ferguson	Mähdrescher / 3400-9790	9790	70			15	
800055N	Massey Ferguson	Mähdrescher / MF 24-40	24	76			15,6	
800055N	Massey Ferguson	Mähdrescher / MF 24-40	27	76			15,6	
800055N	Massey Ferguson	Mähdrescher / MF 24-40	29	76			15,6	
800055N	Massey Ferguson	Mähdrescher / MF 24-40	29XP	76			15,6	
800055N	Massey Ferguson	Mähdrescher / MF 24-40	30	76			15,6	
800055N	Massey Ferguson	Mähdrescher / MF 24-40	31	76			15,6	
800055N	Massey Ferguson	Mähdrescher / MF 24-40	31XP	76			15,6	
800055N	Massey Ferguson	Mähdrescher / MF 24-40	32	76			15,6	
800055N	Massey Ferguson	Mähdrescher / MF 24-40	34	76			15,6	
800055N	Massey Ferguson	Mähdrescher / MF 24-40	36	76			15,6	
800055N	Massey Ferguson	Mähdrescher / MF 24-40	38	76			15,6	
800055N	Massey Ferguson	Mähdrescher / MF 24-40	40	76			15,6	
800367N	Massey Ferguson	Schlepper / 200	230	75				
800367N	Massey Ferguson	Schlepper / 200	233	75				
800367N	Massey Ferguson	Schlepper / 200	234S	75				
800367N	Massey Ferguson	Schlepper / 200	235	75				
800367N	Massey Ferguson	Schlepper / 200	240	75				
800367N	Massey Ferguson	Schlepper / 200	245	75				
800367N	Massey Ferguson	Schlepper / 200	250	75				
800367N	Massey Ferguson	Schlepper / 200	253	75				
800367N	Massey Ferguson	Schlepper / 200	254	75				
800367N	Massey Ferguson	Schlepper / 200	254-4	75				
800367N	Massey Ferguson	Schlepper / 200	254S	75				
800367N	Massey Ferguson	Schlepper / 200	255	75				
800367N	Massey Ferguson	Schlepper / 200	260	75				
800367N	Massey Ferguson	Schlepper / 200	265	75				
800367N	Massey Ferguson	Schlepper / 200	265S	75				
800367N	Massey Ferguson	Schlepper / 200	273	75				
800367N	Massey Ferguson	Schlepper / 200	274	75				

Dasis Nr.	Hersteller	Modell	Typ	Außendurchmesser [mm]	Länge [mm]	Innengewinde 1 [mm]	Außengewinde 1 [mm]	für OE-Nummer
800367N	Massey Ferguson	Schlepper / 200	274-4	75				
800367N	Massey Ferguson	Schlepper / 200	274-4SK	75				
800367N	Massey Ferguson	Schlepper / 200	274S	75				
800367N	Massey Ferguson	Schlepper / 200	274SK	75				
800367N	Massey Ferguson	Schlepper / 200	275	75				
800367N	Massey Ferguson	Schlepper / 200	282	75				
800367N	Massey Ferguson	Schlepper / 200	283	75				
800367N	Massey Ferguson	Schlepper / 200	284	75				
800367N	Massey Ferguson	Schlepper / 200	284-4S	75				
800367N	Massey Ferguson	Schlepper / 200	284S	75				
800367N	Massey Ferguson	Schlepper / 200	285	75				
800367N	Massey Ferguson	Schlepper / 200	290	75				
800367N	Massey Ferguson	Schlepper / 200	293	75				
800367N	Massey Ferguson	Schlepper / 200	294	75				
800367N	Massey Ferguson	Schlepper / 200	294-4	75				
800367N	Massey Ferguson	Schlepper / 200	294-4S	75				
800367N	Massey Ferguson	Schlepper / 200	294S	75				
800367N	Massey Ferguson	Schlepper / 200	294S-4S	75				
800367N	Massey Ferguson	Schlepper / 200	298	75				
800153N	Massey Ferguson	Schlepper / 300	340	70			16	
800055N	Massey Ferguson	Schlepper / 300	340	76			15,6	
800153N	Massey Ferguson	Schlepper / 300	342	70			16	
800055N	Massey Ferguson	Schlepper / 300	342	76			15,6	
800153N	Massey Ferguson	Schlepper / 300	350	70			16	
800055N	Massey Ferguson	Schlepper / 300	350	76			15,6	
800153N	Massey Ferguson	Schlepper / 300	352	70			16	
800055N	Massey Ferguson	Schlepper / 300	352	76			15,6	
800153N	Massey Ferguson	Schlepper / 300	353	70			16	
800055N	Massey Ferguson	Schlepper / 300	353	76			15,6	
800153N	Massey Ferguson	Schlepper / 300	354	70			16	
800055N	Massey Ferguson	Schlepper / 300	354	76			15,6	

Dasis Nr.	Hersteller	Modell	Typ	Außendurchmesser [mm]	Länge [mm]	Innengewinde 1 [mm]	Außengewinde 1 [mm]	für OE-Nummer
800153N	Massey Ferguson	Schlepper / 300	355	70			16	
800055N	Massey Ferguson	Schlepper / 300	355	76			15,6	
800153N	Massey Ferguson	Schlepper / 300	360	70			16	
800055N	Massey Ferguson	Schlepper / 300	360	76			15,6	
800153N	Massey Ferguson	Schlepper / 300	362	70			16	
800055N	Massey Ferguson	Schlepper / 300	362	76			15,6	
800055N	Massey Ferguson	Schlepper / 300	362N	76			15,6	
800153N	Massey Ferguson	Schlepper / 300	363	70			16	
800055N	Massey Ferguson	Schlepper / 300	363	76			15,6	
800153N	Massey Ferguson	Schlepper / 300	365	70			16	
800055N	Massey Ferguson	Schlepper / 300	365	76			15,6	
800153N	Massey Ferguson	Schlepper / 300	372	70			16	
800055N	Massey Ferguson	Schlepper / 300	372	76			15,6	
800055N	Massey Ferguson	Schlepper / 300	372N	76			15,6	
800154N	Massey Ferguson	Schlepper / 300	373	62				
800154N	Massey Ferguson	Schlepper / 300	373S	62				
800154N	Massey Ferguson	Schlepper / 300	374	62				
800154N	Massey Ferguson	Schlepper / 300	374S	62				
800153N	Massey Ferguson	Schlepper / 300	375	70			16	
800055N	Massey Ferguson	Schlepper / 300	375	76			15,6	
800153N	Massey Ferguson	Schlepper / 300	377	70			16	
800055N	Massey Ferguson	Schlepper / 300	377	76			15,6	
800153N	Massey Ferguson	Schlepper / 300	382	70			16	
800055N	Massey Ferguson	Schlepper / 300	382	76			15,6	
800055N	Massey Ferguson	Schlepper / 300	382N	76			15,6	
800154N	Massey Ferguson	Schlepper / 300	383	62				
800154N	Massey Ferguson	Schlepper / 300	383S	62				
800154N	Massey Ferguson	Schlepper / 300	384	62				
800153N	Massey Ferguson	Schlepper / 300	384S	70			16	
800055N	Massey Ferguson	Schlepper / 300	384S	76			15,6	
800153N	Massey Ferguson	Schlepper / 300	387	70			16	

Dasis Nr.	Hersteller	Modell	Typ	Außendurchmesser [mm]	Länge [mm]	Innengewinde 1 [mm]	Außengewinde 1 [mm]	für OE-Nummer
800055N	Massey Ferguson	Schlepper / 300	387	76			15,6	
800153N	Massey Ferguson	Schlepper / 300	390	70			16	
800055N	Massey Ferguson	Schlepper / 300	390	76			15,6	
800153N	Massey Ferguson	Schlepper / 300	390T	70			16	
800055N	Massey Ferguson	Schlepper / 300	390T	76			15,6	
800154N	Massey Ferguson	Schlepper / 300	393	62				
800154N	Massey Ferguson	Schlepper / 300	393S	62				
800154N	Massey Ferguson	Schlepper / 300	394	62				
800154N	Massey Ferguson	Schlepper / 300	394F	62				
800154N	Massey Ferguson	Schlepper / 300	394S	62				
800153N	Massey Ferguson	Schlepper / 300	397	70			16	
800055N	Massey Ferguson	Schlepper / 300	397	76			15,6	
800153N	Massey Ferguson	Schlepper / 300	398	70			16	
800055N	Massey Ferguson	Schlepper / 300	398	76			15,6	
800153N	Massey Ferguson	Schlepper / 300	399	70			16	
800055N	Massey Ferguson	Schlepper / 300	399	76			15,6	
800386N	Massey Ferguson	Schlepper / 500	550	76				
800386N	Massey Ferguson	Schlepper / 500	560	76				
800386N	Massey Ferguson	Schlepper / 500	565	76				
800386N	Massey Ferguson	Schlepper / 500	575	76				
800386N	Massey Ferguson	Schlepper / 500	590	76				
800386N	Massey Ferguson	Schlepper / 500	592	76				
800386N	Massey Ferguson	Schlepper / 500	595	76				
800386N	Massey Ferguson	Schlepper / 500	595K	76				
800367N	Massey Ferguson	Schlepper / 600-800	670	75				
800367N	Massey Ferguson	Schlepper / 600-800	675	75				
800367N	Massey Ferguson	Schlepper / 600-800	690	75				
800367N	Massey Ferguson	Schlepper / 600-800	698	75				
800367N	Massey Ferguson	Schlepper / 600-800	698T	75				
800367N	Massey Ferguson	Schlepper / 600-800	699	75				
800154N	Massey Ferguson	Schlepper / 1000	1004	62				



Dasis Nr.	Hersteller	Modell	Typ	Außendurchmesser [mm]	Länge [mm]	Innengewinde 1 [mm]	Außengewinde 1 [mm]	für OE-Nummer
800154N	Massey Ferguson	Schlepper / 1000	1007	62				
800154N	Massey Ferguson	Schlepper / 1000	1014	62				
800154N	Massey Ferguson	Schlepper / 1000	1080	62				
800154N	Massey Ferguson	Schlepper / 1000	1085	62				
800154N	Massey Ferguson	Schlepper / 1000	1100	62				
800154N	Massey Ferguson	Schlepper / 1000	1105	62				
800154N	Massey Ferguson	Schlepper / 1000	1114	62				
800154N	Massey Ferguson	Schlepper / 1000	1130	62				
800154N	Massey Ferguson	Schlepper / 1000	1134	62				
800154N	Massey Ferguson	Schlepper / 1000	1135	62				
800154N	Massey Ferguson	Schlepper / 1000	1155	62				
800154N	Massey Ferguson	Schlepper / 1000	1200	62				
800154N	Massey Ferguson	Schlepper / 1000	1250	62				
800154N	Massey Ferguson	Schlepper / 2000	2210	62				
800154N	Massey Ferguson	Schlepper / 2000	2220	62				
800154N	Massey Ferguson	Schlepper / 2000	2225	62				
800154N	Massey Ferguson	Schlepper / 2000	2230	62				
800154N	Massey Ferguson	Schlepper / 2000	2235	62				
802110N	Massey Ferguson	Schlepper / 2000	2620	63,5			11	
802110N	Massey Ferguson	Schlepper / 2000	2625	63,5			11	
802110N	Massey Ferguson	Schlepper / 2000	2640	63,5			11	
802110N	Massey Ferguson	Schlepper / 2000	2645	63,5			11	
802110N	Massey Ferguson	Schlepper / 2000	2675	63,5			11	
802110N	Massey Ferguson	Schlepper / 2000	2680	63,5			11	
802110N	Massey Ferguson	Schlepper / 2000	2685	63,5			11	
800224N	Massey Ferguson	Schlepper / 2000	2705	63,5				
800224N	Massey Ferguson	Schlepper / 2000	2720	63,5				
800224N	Massey Ferguson	Schlepper / 2000	2725	63,5				
800224N	Massey Ferguson	Schlepper / 2000	2775	63,5				
802110N	Massey Ferguson	Schlepper / 2000	2805	63,5			11	
801240N	Massey Ferguson	Schlepper / 3000	3050	67			15,7	

Dasis Nr.	Hersteller	Modell	Typ	Außendurchmesser [mm]	Länge [mm]	Innengewinde 1 [mm]	Außengewinde 1 [mm]	für OE-Nummer
800055N	Massey Ferguson	Schlepper / 3000	3050	76			15,6	
801240N	Massey Ferguson	Schlepper / 3000	3060	67			15,7	
800055N	Massey Ferguson	Schlepper / 3000	3060	76			15,6	
801240N	Massey Ferguson	Schlepper / 3000	3065	67			15,7	
800055N	Massey Ferguson	Schlepper / 3000	3065	76			15,6	
800055N	Massey Ferguson	Schlepper / 3000	3070	76			15,6	
801240N	Massey Ferguson	Schlepper / 3000	3075	67			15,7	
800055N	Massey Ferguson	Schlepper / 3000	3075	76			15,6	
800055N	Massey Ferguson	Schlepper / 3000	3080	76			15,6	
801240N	Massey Ferguson	Schlepper / 3000	3085	67			15,7	
800055N	Massey Ferguson	Schlepper / 3000	3085	76			15,6	
800055N	Massey Ferguson	Schlepper / 3000	3090	76			15,6	
801240N	Massey Ferguson	Schlepper / 3000	3095	67			15,7	
800055N	Massey Ferguson	Schlepper / 3000	3095	76			15,6	
800055N	Massey Ferguson	Schlepper / 3000	3115	76			15,6	
801240N	Massey Ferguson	Schlepper / 3000	3120	67			15,7	
800055N	Massey Ferguson	Schlepper / 3000	3120	76			15,6	
800055N	Massey Ferguson	Schlepper / 3000	3120T	76			15,6	
801240N	Massey Ferguson	Schlepper / 3000	3125	67			15,7	
800055N	Massey Ferguson	Schlepper / 3000	3125	76			15,6	
800055N	Massey Ferguson	Schlepper / 3000	3140	76			15,6	
800372N	Massey Ferguson	Schlepper / 3000	3425S	76				
800372N	Massey Ferguson	Schlepper / 3000	3435S	76				
800372N	Massey Ferguson	Schlepper / 3000	3445S	76				
800372N	Massey Ferguson	Schlepper / 3000	3455S	76				
800545N	Massey Ferguson	Schlepper / 3000	3505	76				
800545N	Massey Ferguson	Schlepper / 3000	3525	76				
800545N	Massey Ferguson	Schlepper / 3000	3545	76				
800055N	Massey Ferguson	Schlepper / 3000	3610	76			15,6	
800055N	Massey Ferguson	Schlepper / 3000	3630	76			15,6	
801240N	Massey Ferguson	Schlepper / 3000	3635	67			15,7	

Dasis Nr.	Hersteller	Modell	Typ	Außendurchmesser [mm]	Länge [mm]	Innengewinde 1 [mm]	Außengewinde 1 [mm]	für OE-Nummer
800055N	Massey Ferguson	Schlepper / 3000	3635	76			15,6	
801240N	Massey Ferguson	Schlepper / 3000	3645	67			15,7	
800055N	Massey Ferguson	Schlepper / 3000	3645	76			15,6	
800055N	Massey Ferguson	Schlepper / 3000	3650	76			15,6	
801240N	Massey Ferguson	Schlepper / 3000	3655	67			15,7	
800055N	Massey Ferguson	Schlepper / 3000	3655	76			15,6	
800055N	Massey Ferguson	Schlepper / 3000	3660	76			15,6	
801240N	Massey Ferguson	Schlepper / 3000	3670	67			15,7	
800055N	Massey Ferguson	Schlepper / 3000	3670	76			15,6	
800055N	Massey Ferguson	Schlepper / 3000	3680	76			15,6	
801240N	Massey Ferguson	Schlepper / 3000	3690	67			15,7	
800055N	Massey Ferguson	Schlepper / 3000	3690	76			15,6	
801240N	Massey Ferguson	Schlepper / 4000	4225	67			15,7	
801240N	Massey Ferguson	Schlepper / 4000	4235	67			15,7	
801240N	Massey Ferguson	Schlepper / 4000	4240	67			15,7	
801240N	Massey Ferguson	Schlepper / 4000	4245	67			15,7	
801240N	Massey Ferguson	Schlepper / 4000	4255	67			15,7	
801240N	Massey Ferguson	Schlepper / 4000	4260	67			15,7	
801240N	Massey Ferguson	Schlepper / 4000	4270	67			15,7	
801240N	Massey Ferguson	Schlepper / 4000	4325	67			15,7	
801240N	Massey Ferguson	Schlepper / 4000	4335	67			15,7	
801240N	Massey Ferguson	Schlepper / 4000	4345	67			15,7	
801240N	Massey Ferguson	Schlepper / 4000	4355	67			15,7	
801240N	Massey Ferguson	Schlepper / 4000	4360	67			15,7	
801240N	Massey Ferguson	Schlepper / 4000	4370	67			15,7	
801240N	Massey Ferguson	Schlepper / 5000	5425	67			15,7	
801240N	Massey Ferguson	Schlepper / 5000	5435	67			15,7	
801240N	Massey Ferguson	Schlepper / 5000	5445	67			15,7	
801240N	Massey Ferguson	Schlepper / 5000	5455	67			15,7	
801240N	Massey Ferguson	Schlepper / 5000	5460	67			15,7	
801240N	Massey Ferguson	Schlepper / 5000	5465	67			15,7	

Dasis Nr.	Hersteller	Modell	Typ	Außendurchmesser [mm]	Länge [mm]	Innengewinde 1 [mm]	Außengewinde 1 [mm]	für OE-Nummer
801240N	Massey Ferguson	Schlepper / 5000	5470	67			15,7	
801240N	Massey Ferguson	Schlepper / 5000	5480	67			15,7	
801240N	Massey Ferguson	Schlepper / 6000	6120	67			15,7	
801240N	Massey Ferguson	Schlepper / 6000	6130	67			15,7	
801240N	Massey Ferguson	Schlepper / 6000	6140	67			15,7	
801240N	Massey Ferguson	Schlepper / 6000	6150	67			15,7	
801240N	Massey Ferguson	Schlepper / 6000	6160	67			15,7	
801240N	Massey Ferguson	Schlepper / 6000	6170	67			15,7	
801240N	Massey Ferguson	Schlepper / 6000	6180	67			15,7	
801240N	Massey Ferguson	Schlepper / 6000	6190	67			15,7	
801240N	Massey Ferguson	Schlepper / 6000	6260	67			15,7	
801240N	Massey Ferguson	Schlepper / 6000	6265	67			15,7	
801240N	Massey Ferguson	Schlepper / 6000	6270	67			15,7	
801240N	Massey Ferguson	Schlepper / 6000	6280	67			15,7	
801240N	Massey Ferguson	Schlepper / 6000	6290	67			15,7	
801240N	Massey Ferguson	Schlepper / 6000	6445	67			15,7	
801240N	Massey Ferguson	Schlepper / 6000	6455	67			15,7	
801240N	Massey Ferguson	Schlepper / 6000	6460	67			15,7	
801240N	Massey Ferguson	Schlepper / 6000	6465	67			15,7	
801240N	Massey Ferguson	Schlepper / 6000	6470	67			15,7	
801240N	Massey Ferguson	Schlepper / 6000	6475	67			15,7	
801240N	Massey Ferguson	Schlepper / 6000	6480	67			15,7	
801240N	Massey Ferguson	Schlepper / 6000	6485	67			15,7	
801240N	Massey Ferguson	Schlepper / 6000	6490	67			15,7	
801240N	Massey Ferguson	Schlepper / 6000	6495	67			15,7	
801240N	Massey Ferguson	Schlepper / 6000	6497	67			15,7	
801240N	Massey Ferguson	Schlepper / 6000	6499	67			15,7	
801240N	Massey Ferguson	Schlepper / 7000	7465	67			15,7	
801240N	Massey Ferguson	Schlepper / 7000	7475	67			15,7	
801240N	Massey Ferguson	Schlepper / 7000	7480	67			15,7	
801240N	Massey Ferguson	Schlepper / 7000	7485	67			15,7	

Dasis Nr.	Hersteller	Modell	Typ	Außendurchmesser [mm]	Länge [mm]	Innengewinde 1 [mm]	Außengewinde 1 [mm]	für OE-Nummer
801240N	Massey Ferguson	Schlepper / 7000	7490	67			15,7	
801240N	Massey Ferguson	Schlepper / 7000	7495	67			15,7	
801240N	Massey Ferguson	Schlepper / 7000	7495Räder3	67			15,7	
801240N	Massey Ferguson	Schlepper / 8000	8110	67			15,7	
801240N	Massey Ferguson	Schlepper / 8000	8120	67			15,7	
801240N	Massey Ferguson	Schlepper / 8000	8130	67			15,7	
801240N	Massey Ferguson	Schlepper / 8000	8140	67			15,7	
801240N	Massey Ferguson	Schlepper / 8000	8150	67			15,7	
801240N	Massey Ferguson	Schlepper / 8000	8160	67			15,7	
801240N	Massey Ferguson	Schlepper / 8000	8170	67			15,7	
801240N	Massey Ferguson	Schlepper / 8000	8180	67			15,7	
801240N	Massey Ferguson	Schlepper / 8000	8210	67			15,7	
801240N	Massey Ferguson	Schlepper / 8000	8220	67			15,7	
801240N	Massey Ferguson	Schlepper / 8000	8240	67			15,7	
801240N	Massey Ferguson	Schlepper / 8000	8250	67			15,7	
801240N	Massey Ferguson	Schlepper / 8000	8260	67			15,7	
801240N	Massey Ferguson	Schlepper / 8000	8270	67			15,7	
801240N	Massey Ferguson	Schlepper / 8000	8280	67			15,7	
800154N	Massey Ferguson	Schlepper / 8000	8939	62				
800064N	Massey Ferguson	Schlepper / Dronningborg	24	76			16	
800064N	Massey Ferguson	Schlepper / Dronningborg	29P	76			16	
800064N	Massey Ferguson	Schlepper / Dronningborg	30	76			16	
800064N	Massey Ferguson	Schlepper / Dronningborg	31P	76			16	
800064N	Massey Ferguson	Schlepper / Dronningborg	32	76			16	
800064N	Massey Ferguson	Schlepper / Dronningborg	34	76			16	
800064N	Massey Ferguson	Schlepper / Dronningborg	36	76			16	
800064N	Massey Ferguson	Schlepper / Dronningborg	38	76			16	
800064N	Massey Ferguson	Schlepper / Dronningborg	40	76			16	
800372N	Massey Ferguson	Schlepper Obst Wein / 3300F	3315F	76				
800372N	Massey Ferguson	Schlepper Obst Wein / 3300F	3325F	76				

Dasis Nr.	Hersteller	Modell	Typ	Außendurchmesser [mm]	Länge [mm]	Innengewinde 1 [mm]	Außengewinde 1 [mm]	für OE-Nummer
800372N	Massey Ferguson	Schlepper Obst Wein / 3300F	3330F	76				
800372N	Massey Ferguson	Schlepper Obst Wein / 3300F	3340F	76				
800372N	Massey Ferguson	Schlepper Obst Wein / 3300F	3350F	76				
800372N	Massey Ferguson	Schlepper Obst Wein / 3300F	3355F	76				
800372N	Massey Ferguson	Schlepper Obst Wein / 3300S	3315S	76				
800372N	Massey Ferguson	Schlepper Obst Wein / 3300S	3325S	76				
800372N	Massey Ferguson	Schlepper Obst Wein / 3300S	3330S	76				
800372N	Massey Ferguson	Schlepper Obst Wein / 3300S	3340S	76				
800372N	Massey Ferguson	Schlepper Obst Wein / 3300S	3350S	76				
800372N	Massey Ferguson	Schlepper Obst Wein / 3300S	3355S	76				
800372N	Massey Ferguson	Schlepper Obst Wein / 3300V	3315V	76				
800372N	Massey Ferguson	Schlepper Obst Wein / 3300V	3325V	76				
800372N	Massey Ferguson	Schlepper Obst Wein / 3300V	3330V	76				
800372N	Massey Ferguson	Schlepper Obst Wein / 3300V	3340V	76				
800372N	Massey Ferguson	Schlepper Obst Wein / 3300V	3350V	76				
800372N	Massey Ferguson	Schlepper Obst Wein / 3300V	3355V	76				
800372N	Massey Ferguson	Schlepper Obst Wein / 3400F	3425F	76				
800372N	Massey Ferguson	Schlepper Obst Wein / 3400F	3435F	76				
800372N	Massey Ferguson	Schlepper Obst Wein / 3400F	3445F	76				
800372N	Massey Ferguson	Schlepper Obst Wein / 3400F	3455F	76				
801240N	Massey Ferguson	Schlepper Obst Wein / 8400	8450	67			15,7	
801240N	Massey Ferguson	Schlepper Obst Wein / 8400	8460	67			15,7	

Dasis Nr.	Hersteller	Modell	Typ	Außendurchmesser [mm]	Länge [mm]	Innengewinde 1 [mm]	Außengewinde 1 [mm]	für OE-Nummer
801240N	Massey Ferguson	Schlepper Obst Wein / 8400	8470	67			15,7	
801240N	Massey Ferguson	Schlepper Obst Wein / 8400	8480	67			15,7	
800544N	MC Cormick	Schlepper / CMAX	85a	65		13	15	
800018N	MC Cormick	Schlepper / CX	70	102		14	16	
800018N	MC Cormick	Schlepper / CX	80	102		14	16	
800018N	MC Cormick	Schlepper / CX	90	102		14	16	
800018N	MC Cormick	Schlepper / CX	100	102		14	16	
800544N	MC Cormick	Schlepper / F	85	65		13	15	
800544N	MC Cormick	Schlepper / F	90	65		13	15	
800018N	MC Cormick	Schlepper / MC	80	102		14	16	
800018N	MC Cormick	Schlepper / MC	90	102		14	16	
800018N	MC Cormick	Schlepper / MC	100	102		14	16	
800018N	MC Cormick	Schlepper / MC	115	102		14	16	
800018N	MC Cormick	Schlepper / MC	120	102		14	16	
800018N	MC Cormick	Schlepper / MC	135	102		14	16	
800018N	MC Cormick	Schlepper / MTX	110	102		14	16	
800018N	MC Cormick	Schlepper / MTX	120	102		14	16	
800018N	MC Cormick	Schlepper / MTX	125	102		14	16	
800018N	MC Cormick	Schlepper / MTX	135	102		14	16	
800018N	MC Cormick	Schlepper / MTX	140	102		14	16	
800018N	MC Cormick	Schlepper / MTX	150	102		14	16	
800018N	MC Cormick	Schlepper / MTX	155	102		14	16	
800018N	MC Cormick	Schlepper / MTX	165	102		14	16	
800018N	MC Cormick	Schlepper / MTX	175	102		14	16	
800018N	MC Cormick	Schlepper / MTX	185	102		14	16	
800018N	MC Cormick	Schlepper / XTX	185	102		14	16	
800018N	MC Cormick	Schlepper / XTX	200	102		14	16	
800018N	MC Cormick	Schlepper / XTX	215	102		14	16	
800018N	MC Cormick	Schlepper / ZTX	230	102		14	16	
800018N	MC Cormick	Schlepper / ZTX	260	102		14	16	
800018N	MC Cormick	Schlepper / ZTX	280	102		14	16	

Dasis Nr.	Hersteller	Modell	Typ	Außendurchmesser [mm]	Länge [mm]	Innengewinde 1 [mm]	Außengewinde 1 [mm]	für OE-Nummer
800154N	Merlo	Teleskoplader	25.9	62				
800154N	Merlo	Teleskoplader	27.9	62				
800154N	Merlo	Teleskoplader	28.7	62				
800154N	Merlo	Teleskoplader	28.9	62				
800154N	Merlo	Teleskoplader	30.7	62				
800154N	Merlo	Teleskoplader	32.7	62				
800154N	Merlo	Teleskoplader	35.7	62				
800154N	Merlo	Teleskoplader	40.8	62				
800372N	Merlo	Teleskoplader	KabineK	76				
800296N	Merlo	Teleskoplader	KabineK	76				
800244N	NEW HOLLAND	Baggerlader / 230-234	230A	63,5				
800244N	NEW HOLLAND	Baggerlader / 230-234	231	63,5				
800244N	NEW HOLLAND	Baggerlader / 230-234	233	63,5				
800244N	NEW HOLLAND	Baggerlader / 230-234	234	63,5				
800367N	NEW HOLLAND	Baggerlader / 550-575E	515	75				
800367N	NEW HOLLAND	Baggerlader / 550-575E	530A	75				
800367N	NEW HOLLAND	Baggerlader / 550-575E	531	75				
800367N	NEW HOLLAND	Baggerlader / 550-575E	532	75				
800367N	NEW HOLLAND	Baggerlader / 550-575E	540	75				
800367N	NEW HOLLAND	Baggerlader / 550-575E	550	75				
803972N	NEW HOLLAND	Baggerlader / 550-575E	555	76			16	
800010N	NEW HOLLAND	Baggerlader / 550-575E	555	76		14,7	15,8	
800015N	NEW HOLLAND	Baggerlader / 550-575E	555	102				
800015N	NEW HOLLAND	Baggerlader / 550-575E	575	102				
800015N	NEW HOLLAND	Baggerlader / 655-755A	655	102				
803972N	NEW HOLLAND	Baggerlader / 655-755A	675	76			16	
800015N	NEW HOLLAND	Baggerlader / 655-755A	675	102				
803972N	NEW HOLLAND	Baggerlader / 655-755A	675E	76			16	
800386N	NEW HOLLAND	Baggerlader / 9000	9030	76				
803972N	NEW HOLLAND	Baggerlader / LB	75	76			16	
803972N	NEW HOLLAND	Baggerlader / LB	90	76			16	



Dasis Nr.	Hersteller	Modell	Typ	Außendurchmesser [mm]	Länge [mm]	Innengewinde 1 [mm]	Außengewinde 1 [mm]	für OE-Nummer
803972N	NEW HOLLAND	Baggerlader / LB	110	76			16	
800375N	NEW HOLLAND	Baggerlader / TR	96	76			16	
800367N	NEW HOLLAND	Mähdrescher / 1000	1038	75				
800367N	NEW HOLLAND	Mähdrescher / 1000	1078	75				
800367N	NEW HOLLAND	Mähdrescher / 1000	1079	75				
800367N	NEW HOLLAND	Mähdrescher / 1000	1085	75				
800677N	NEW HOLLAND	Mähdrescher / 7000	7030M	10				47465067 47465072
800677N	NEW HOLLAND	Mähdrescher / 8000	8030L	10				47465067 47465072
800535N	NEW HOLLAND	Mähdrescher / CR	920	70			15	
800015N	NEW HOLLAND	Mähdrescher / CR	920	102				
800535N	NEW HOLLAND	Mähdrescher / CR	940	70			15	
800015N	NEW HOLLAND	Mähdrescher / CR	940	102				
800535N	NEW HOLLAND	Mähdrescher / CR	960	70			15	
800015N	NEW HOLLAND	Mähdrescher / CR	960	102				
800535N	NEW HOLLAND	Mähdrescher / CR	970	70			15	
800015N	NEW HOLLAND	Mähdrescher / CR	970	102				
800535N	NEW HOLLAND	Mähdrescher / CR	980	70			15	
800015N	NEW HOLLAND	Mähdrescher / CR	980	102				
800377N	NEW HOLLAND	Mähdrescher / CS	520	76		14	10	
800377N	NEW HOLLAND	Mähdrescher / CS	540	76		14	10	
800377N	NEW HOLLAND	Mähdrescher / CS	640	76		14	10	
800377N	NEW HOLLAND	Mähdrescher / CS	660	76		14	10	
800377N	NEW HOLLAND	Mähdrescher / CX	720	76		14	10	
800377N	NEW HOLLAND	Mähdrescher / CX	740	76		14	10	
800377N	NEW HOLLAND	Mähdrescher / CX	760	76		14	10	
800377N	NEW HOLLAND	Mähdrescher / CX	780	76		14	10	
800377N	NEW HOLLAND	Mähdrescher / CX	820	76		14	10	
800377N	NEW HOLLAND	Mähdrescher / CX	840	76		14	10	
800377N	NEW HOLLAND	Mähdrescher / CX	860	76		14	10	
800055N	NEW HOLLAND	Mähdrescher / TC	52	76			15,6	
800055N	NEW HOLLAND	Mähdrescher / TC	54	76			15,6	

Dasis Nr.	Hersteller	Modell	Typ	Außendurchmesser [mm]	Länge [mm]	Innengewinde 1 [mm]	Außengewinde 1 [mm]	für OE-Nummer
800055N	NEW HOLLAND	Mähdrescher / TC	56	76			15,6	
800055N	NEW HOLLAND	Mähdrescher / TF	42	76			15,6	
800055N	NEW HOLLAND	Mähdrescher / TF	44	76			15,6	
800055N	NEW HOLLAND	Mähdrescher / TF	46	76			15,6	
800055N	NEW HOLLAND	Mähdrescher / TN	8030	76			15,6	
800055N	NEW HOLLAND	Mähdrescher / TN	8040	76			15,6	
800055N	NEW HOLLAND	Mähdrescher / TN	8050	76			15,6	
800055N	NEW HOLLAND	Mähdrescher / TN	8055	76			15,6	
800055N	NEW HOLLAND	Mähdrescher / TN	8060	76			15,6	
800055N	NEW HOLLAND	Mähdrescher / TN	8070	76			15,6	
800055N	NEW HOLLAND	Mähdrescher / TN	8080	76			15,6	
800367N	NEW HOLLAND	Mähdrescher / TR	70	75				
800367N	NEW HOLLAND	Mähdrescher / TR	75	75				
800375N	NEW HOLLAND	Mähdrescher / TR	76	76			16	
800375N	NEW HOLLAND	Mähdrescher / TR	85	76			16	
800375N	NEW HOLLAND	Mähdrescher / TR	86	76			16	
800375N	NEW HOLLAND	Mähdrescher / TR	98	76			16	
800529N	NEW HOLLAND	Schlepper / 670-8970	800	102			14	
800204N	NEW HOLLAND	Schlepper / 670-8970	8670	76				
800204N	NEW HOLLAND	Schlepper / 670-8970	8770	76				
800204N	NEW HOLLAND	Schlepper / 670-8970	8870	76				
800204N	NEW HOLLAND	Schlepper / 670-8970	8970	76				
800529N	NEW HOLLAND	Schlepper / 900	900	102			14	
800055N	NEW HOLLAND	Schlepper / 1905-2405	1905	76			15,6	
800055N	NEW HOLLAND	Schlepper / 1905-2405	2205	76			15,6	
800055N	NEW HOLLAND	Schlepper / 1905-2405	2305	76			15,6	
800055N	NEW HOLLAND	Schlepper / 1905-2405	2405	76			15,6	
800046N	NEW HOLLAND	Schlepper / 2110-8210	2310	102				
800542N	NEW HOLLAND	Schlepper / 2110-8210	2310	102			16	
800046N	NEW HOLLAND	Schlepper / 2110-8210	2610	102				
800542N	NEW HOLLAND	Schlepper / 2110-8210	2610	102			16	

Dasis Nr.	Hersteller	Modell	Typ	Außendurchmesser [mm]	Länge [mm]	Innengewinde 1 [mm]	Außengewinde 1 [mm]	für OE-Nummer
800046N	NEW HOLLAND	Schlepper / 2110-8210	2810	102				
800542N	NEW HOLLAND	Schlepper / 2110-8210	2810	102			16	
800046N	NEW HOLLAND	Schlepper / 2110-8210	2910	102				
800542N	NEW HOLLAND	Schlepper / 2110-8210	2910	102			16	
800046N	NEW HOLLAND	Schlepper / 2110-8210	3310	102				
800542N	NEW HOLLAND	Schlepper / 2110-8210	3310	102			16	
800046N	NEW HOLLAND	Schlepper / 2110-8210	3610	102				
800542N	NEW HOLLAND	Schlepper / 2110-8210	3610	102			16	
800046N	NEW HOLLAND	Schlepper / 2110-8210	3910	102				
800542N	NEW HOLLAND	Schlepper / 2110-8210	3910	102			16	
800046N	NEW HOLLAND	Schlepper / 2110-8210	4110	102				
800542N	NEW HOLLAND	Schlepper / 2110-8210	4110	102			16	
800046N	NEW HOLLAND	Schlepper / 2110-8210	4610	102				
800542N	NEW HOLLAND	Schlepper / 2110-8210	4610	102			16	
800046N	NEW HOLLAND	Schlepper / 2110-8210	5110	102				
800542N	NEW HOLLAND	Schlepper / 2110-8210	5110	102			16	
800046N	NEW HOLLAND	Schlepper / 2110-8210	5610	102				
800542N	NEW HOLLAND	Schlepper / 2110-8210	5610	102			16	
800046N	NEW HOLLAND	Schlepper / 2110-8210	5710	102				
800542N	NEW HOLLAND	Schlepper / 2110-8210	5710	102			16	
800046N	NEW HOLLAND	Schlepper / 2110-8210	5900	102				
800542N	NEW HOLLAND	Schlepper / 2110-8210	5900	102			16	
800046N	NEW HOLLAND	Schlepper / 2110-8210	6410	102				
800542N	NEW HOLLAND	Schlepper / 2110-8210	6410	102			16	
800046N	NEW HOLLAND	Schlepper / 2110-8210	6610	102				
800542N	NEW HOLLAND	Schlepper / 2110-8210	6610	102			16	
800046N	NEW HOLLAND	Schlepper / 2110-8210	6710	102				
800542N	NEW HOLLAND	Schlepper / 2110-8210	6710	102			16	
800046N	NEW HOLLAND	Schlepper / 2110-8210	6810	102				
800542N	NEW HOLLAND	Schlepper / 2110-8210	6810	102			16	
800046N	NEW HOLLAND	Schlepper / 2110-8210	7410	102				

Dasis Nr.	Hersteller	Modell	Typ	Außendurchmesser [mm]	Länge [mm]	Innengewinde 1 [mm]	Außengewinde 1 [mm]	für OE-Nummer
800542N	NEW HOLLAND	Schlepper / 2110-8210	7410	102			16	
800046N	NEW HOLLAND	Schlepper / 2110-8210	7610	102				
800542N	NEW HOLLAND	Schlepper / 2110-8210	7610	102			16	
800046N	NEW HOLLAND	Schlepper / 2110-8210	7710	102				
800542N	NEW HOLLAND	Schlepper / 2110-8210	7710	102			16	
800046N	NEW HOLLAND	Schlepper / 2110-8210	7810	102				
800542N	NEW HOLLAND	Schlepper / 2110-8210	7810	102			16	
800046N	NEW HOLLAND	Schlepper / 2110-8210	7910	102				
800542N	NEW HOLLAND	Schlepper / 2110-8210	7910	102			16	
800046N	NEW HOLLAND	Schlepper / 2110-8210	8210	102				
800542N	NEW HOLLAND	Schlepper / 2110-8210	8210	102			16	
800542N	NEW HOLLAND	Schlepper / 3230-8930	3230	102			16	
800542N	NEW HOLLAND	Schlepper / 3230-8930	3430	102			16	
800542N	NEW HOLLAND	Schlepper / 3230-8930	3930	102			16	
800542N	NEW HOLLAND	Schlepper / 3230-8930	3930H	102			16	
800542N	NEW HOLLAND	Schlepper / 3230-8930	4130	102			16	
800542N	NEW HOLLAND	Schlepper / 3230-8930	4330	102			16	
800542N	NEW HOLLAND	Schlepper / 3230-8930	4630	102			16	
800542N	NEW HOLLAND	Schlepper / 3230-8930	4830	102			16	
800542N	NEW HOLLAND	Schlepper / 3230-8930	5030	102			16	
800542N	NEW HOLLAND	Schlepper / 3230-8930	8530	102			16	
800542N	NEW HOLLAND	Schlepper / 3230-8930	8630	102			16	
800542N	NEW HOLLAND	Schlepper / 3230-8930	8730	102			16	
800542N	NEW HOLLAND	Schlepper / 3230-8930	8830	102			16	
800559N	NEW HOLLAND	Schlepper / 3435-7635	3435	76			15	
800559N	NEW HOLLAND	Schlepper / 3435-7635	3935	76			15	
800559N	NEW HOLLAND	Schlepper / 3435-7635	4135	76			15	
800559N	NEW HOLLAND	Schlepper / 3435-7635	4635	76			15	
800559N	NEW HOLLAND	Schlepper / 3435-7635	4835	76			15	
800559N	NEW HOLLAND	Schlepper / 3435-7635	5635	76			15	
800559N	NEW HOLLAND	Schlepper / 3435-7635	6635	76			15	

Dasis Nr.	Hersteller	Modell	Typ	Außendurchmesser [mm]	Länge [mm]	Innengewinde 1 [mm]	Außengewinde 1 [mm]	für OE-Nummer
800559N	NEW HOLLAND	Schlepper / 3435-7635	7635	76			15	
800046N	NEW HOLLAND	Schlepper /4110-8210	5110	102				
800542N	NEW HOLLAND	Schlepper /4110-8210	5110	102			16	
800046N	NEW HOLLAND	Schlepper /4110-8210	5610	102				
800542N	NEW HOLLAND	Schlepper /4110-8210	5610	102			16	
800046N	NEW HOLLAND	Schlepper /4110-8210	6410	102				
800542N	NEW HOLLAND	Schlepper /4110-8210	6410	102			16	
800046N	NEW HOLLAND	Schlepper /4110-8210	6610	102				
800542N	NEW HOLLAND	Schlepper /4110-8210	6610	102			16	
800046N	NEW HOLLAND	Schlepper /4110-8210	6810	102				
800542N	NEW HOLLAND	Schlepper /4110-8210	6810	102			16	
800046N	NEW HOLLAND	Schlepper /4110-8210	7410	102				
800542N	NEW HOLLAND	Schlepper /4110-8210	7410	102			16	
800046N	NEW HOLLAND	Schlepper /4110-8210	7610	102				
800542N	NEW HOLLAND	Schlepper /4110-8210	7610	102			16	
800046N	NEW HOLLAND	Schlepper /4110-8210	7710	102				
800542N	NEW HOLLAND	Schlepper /4110-8210	7710	102			16	
800046N	NEW HOLLAND	Schlepper /4110-8210	7810	102				
800542N	NEW HOLLAND	Schlepper /4110-8210	7810	102			16	
800046N	NEW HOLLAND	Schlepper /4110-8210	7910	102				
800542N	NEW HOLLAND	Schlepper /4110-8210	7910	102			16	
800046N	NEW HOLLAND	Schlepper /4110-8210	8210	102				
800542N	NEW HOLLAND	Schlepper /4110-8210	8210	102			16	
800065N	NEW HOLLAND	Schlepper / 4140-8340	5640	76				
800198N	NEW HOLLAND	Schlepper / 4140-8340	5640	76		14	16	
800065N	NEW HOLLAND	Schlepper / 4140-8340	6640	76				
800198N	NEW HOLLAND	Schlepper / 4140-8340	6640	76		14	16	
800065N	NEW HOLLAND	Schlepper / 4140-8340	7740	76				
800198N	NEW HOLLAND	Schlepper / 4140-8340	7740	76		14	16	
800065N	NEW HOLLAND	Schlepper / 4140-8340	7840	76				
800198N	NEW HOLLAND	Schlepper / 4140-8340	7840	76		14	16	

Dasis Nr.	Hersteller	Modell	Typ	Außendurchmesser [mm]	Länge [mm]	Innengewinde 1 [mm]	Außengewinde 1 [mm]	für OE-Nummer
800065N	NEW HOLLAND	Schlepper / 4140-8340	8240	76				
800198N	NEW HOLLAND	Schlepper / 4140-8340	8240	76		14	16	
800065N	NEW HOLLAND	Schlepper / 4140-8340	8340	76				
800198N	NEW HOLLAND	Schlepper / 4140-8340	8340	76		14	16	
800365N	NEW HOLLAND	Schlepper / 8160-8560	8160	76				
800365N	NEW HOLLAND	Schlepper / 8160-8560	8260	76				
800365N	NEW HOLLAND	Schlepper / 8160-8560	8360	76				
800365N	NEW HOLLAND	Schlepper / 8160-8560	8560	76				
800204N	NEW HOLLAND	Schlepper / 8670-8970	8670	76				
800204N	NEW HOLLAND	Schlepper / 8670-8970	8770	76				
800204N	NEW HOLLAND	Schlepper / 8670-8970	8870	76				
800204N	NEW HOLLAND	Schlepper / 8670-8970	8970	76				
800204N	NEW HOLLAND	Schlepper / 8670A-8970A	8670A	76				
800204N	NEW HOLLAND	Schlepper / 8670A-8970A	8770A	76				
800204N	NEW HOLLAND	Schlepper / 8670A-8970A	8870A	76				
800204N	NEW HOLLAND	Schlepper / 8670A-8970A	8970A	76				
800052N	NEW HOLLAND	Schlepper / FW	20	65			14	
800052N	NEW HOLLAND	Schlepper / FW	30	65			14	
800052N	NEW HOLLAND	Schlepper / FW	40	65			14	
800052N	NEW HOLLAND	Schlepper / FW	60	65			14	
800204N	NEW HOLLAND	Schlepper / G	170	76				
800204N	NEW HOLLAND	Schlepper / G	190	76				
803972N	NEW HOLLAND	Schlepper / LB	115	76			16	
800679N	NEW HOLLAND	Schlepper / T4 Serie	4.65V					47530212
800679N	NEW HOLLAND	Schlepper / T4 Serie	4.75F					47530212
800677N	NEW HOLLAND	Schlepper / T4 Serie	4.75F	10				47465067 47465072
800679N	NEW HOLLAND	Schlepper / T4 Serie	4.75N					47530212
800677N	NEW HOLLAND	Schlepper / T4 Serie	4.75N	10				47465067 47465072
800679N	NEW HOLLAND	Schlepper / T4 Serie	4.75V					47530212
800677N	NEW HOLLAND	Schlepper / T4 Serie	4.75V	10				47465067 47465072
800677N	NEW HOLLAND	Schlepper / T4 Serie	4.85F	10				47465067 47465072

Dasis Nr.	Hersteller	Modell	Typ	Außendurchmesser [mm]	Länge [mm]	Innengewinde 1 [mm]	Außengewinde 1 [mm]	für OE-Nummer
800677N	NEW HOLLAND	Schlepper / T4 Serie	4.85N	10				47465067 47465072
800677N	NEW HOLLAND	Schlepper / T4 Serie	4.85V	10				47465067 47465072
800677N	NEW HOLLAND	Schlepper / T4 Serie	4.105F	10				47465067 47465072
800677N	NEW HOLLAND	Schlepper / T4 Serie	4.105N	10				47465067 47465072
800677N	NEW HOLLAND	Schlepper / T4 Serie	4.105V	10				47465067 47465072
800677N	NEW HOLLAND	Schlepper / T4 Serie	4.115	10				47465067 47465072
800677N	NEW HOLLAND	Schlepper / T5 Serie	T5.95	10				47465067 47465072
800677N	NEW HOLLAND	Schlepper / T5 Serie	T5.100	10				47465067 47465072
800677N	NEW HOLLAND	Schlepper / T5 Serie	T5.105	10				47465067 47465072
800677N	NEW HOLLAND	Schlepper / T5 Serie	T5.110	10				47465067 47465072
800677N	NEW HOLLAND	Schlepper / T5 Serie	T5.115	10				47465067 47465072
800677N	NEW HOLLAND	Schlepper / T5 Serie	T5.120	10				47465067 47465072
800055N	NEW HOLLAND	Schlepper / TC	52	76			15,6	
800055N	NEW HOLLAND	Schlepper / TC	54	76			15,6	
800055N	NEW HOLLAND	Schlepper / TC	56	76			15,6	
800679N	NEW HOLLAND	Schlepper / TD	5.85					47530212
800679N	NEW HOLLAND	Schlepper / TD	5.95					47530212
800679N	NEW HOLLAND	Schlepper / TD	5.105					47530212
800679N	NEW HOLLAND	Schlepper / TD	5.115					47530212
800154N	NEW HOLLAND	Schlepper / TDD	TD55D	62				
800154N	NEW HOLLAND	Schlepper / TDD	TD60D	62				
800154N	NEW HOLLAND	Schlepper / TDD	TD70D	62				
800154N	NEW HOLLAND	Schlepper / TDD	TD75D	62				
800154N	NEW HOLLAND	Schlepper / TDD	TD80D	62				
800154N	NEW HOLLAND	Schlepper / TDD	TD85D	62				
800154N	NEW HOLLAND	Schlepper / TDD	TD90D	62				
800154N	NEW HOLLAND	Schlepper / TDD	TD95D	62				
800055N	NEW HOLLAND	Schlepper / TF	42	76			15,6	
800055N	NEW HOLLAND	Schlepper / TF	44	76			15,6	
800018N	NEW HOLLAND	Schlepper / TG	210	102		14	16	
800015N	NEW HOLLAND	Schlepper / TG	215	102				

Dasis Nr.	Hersteller	Modell	Typ	Außendurchmesser [mm]	Länge [mm]	Innengewinde 1 [mm]	Außengewinde 1 [mm]	für OE-Nummer
800018N	NEW HOLLAND	Schlepper / TG	230	102		14	16	
800015N	NEW HOLLAND	Schlepper / TG	245	102				
800018N	NEW HOLLAND	Schlepper / TG	255	102		14	16	
800015N	NEW HOLLAND	Schlepper / TG	275	102				
800018N	NEW HOLLAND	Schlepper / TG	285	102		14	16	
800015N	NEW HOLLAND	Schlepper / TG	305	102				
800018N	NEW HOLLAND	Schlepper / TJ	275	102		14	16	
800018N	NEW HOLLAND	Schlepper / TJ	325	102		14	16	
800018N	NEW HOLLAND	Schlepper / TJ	330	102		14	16	
800018N	NEW HOLLAND	Schlepper / TJ	355	102		14	16	
800018N	NEW HOLLAND	Schlepper / TJ	380	102		14	16	
800018N	NEW HOLLAND	Schlepper / TJ	425	102		14	16	
800018N	NEW HOLLAND	Schlepper / TJ	430	102		14	16	
800015N	NEW HOLLAND	Schlepper / TJ	480	102				
800018N	NEW HOLLAND	Schlepper / TJ	480	102		14	16	
800015N	NEW HOLLAND	Schlepper / TJ	500	102				
800018N	NEW HOLLAND	Schlepper / TJ	500	102		14	16	
800015N	NEW HOLLAND	Schlepper / TJ	550	102				
800018N	NEW HOLLAND	Schlepper / TJ	550	102		14	16	
800154N	NEW HOLLAND	Schlepper / TL	70	62				
800537N	NEW HOLLAND	Schlepper / TL	70	76		12	11	
800154N	NEW HOLLAND	Schlepper / TL	80	62				
800537N	NEW HOLLAND	Schlepper / TL	80	76		12	11	
800154N	NEW HOLLAND	Schlepper / TL	90	62				
800537N	NEW HOLLAND	Schlepper / TL	90	76		12	11	
800154N	NEW HOLLAND	Schlepper / TL	100	62				
800537N	NEW HOLLAND	Schlepper / TL	100	76		12	11	
800154N	NEW HOLLAND	Schlepper / TLA	70A	62				
800154N	NEW HOLLAND	Schlepper / TLA	80A	62				
800154N	NEW HOLLAND	Schlepper / TLA	90A	62				
800154N	NEW HOLLAND	Schlepper / TLA	100A	62				



Dasis Nr.	Hersteller	Modell	Typ	Außendurchmesser [mm]	Länge [mm]	Innengewinde 1 [mm]	Außengewinde 1 [mm]	für OE-Nummer
800215N	NEW HOLLAND	Schlepper / TM	TM115	76		14	15	
800215N	NEW HOLLAND	Schlepper / TM	TM120	76		14	15	
800215N	NEW HOLLAND	Schlepper / TM	TM125	76		14	15	
800215N	NEW HOLLAND	Schlepper / TM	TM130	76		14	15	
800215N	NEW HOLLAND	Schlepper / TM	TM135	76		14	15	
800215N	NEW HOLLAND	Schlepper / TM	TM140	76		14	15	
800215N	NEW HOLLAND	Schlepper / TM	TM150	76		14	15	
800215N	NEW HOLLAND	Schlepper / TM	TM155	76		14	15	
800215N	NEW HOLLAND	Schlepper / TM	TM165	76		14	15	
800215N	NEW HOLLAND	Schlepper / TM	TM175	76		14	15	
800215N	NEW HOLLAND	Schlepper / TM	TM190	76		14	15	
800055N	NEW HOLLAND	Schlepper / TR	76	76			15,6	
800055N	NEW HOLLAND	Schlepper / TR	85	76			15,6	
800055N	NEW HOLLAND	Schlepper / TR	86	76			15,6	
800055N	NEW HOLLAND	Schlepper / TR	87	76			15,6	
800055N	NEW HOLLAND	Schlepper / TR	88	76			15,6	
800055N	NEW HOLLAND	Schlepper / TR	89	76			15,6	
800055N	NEW HOLLAND	Schlepper / TR	95	76			15,6	
800055N	NEW HOLLAND	Schlepper / TR	96	76			15,6	
800055N	NEW HOLLAND	Schlepper / TR	97	76			15,6	
800055N	NEW HOLLAND	Schlepper / TR	98	76			15,6	
800055N	NEW HOLLAND	Schlepper / TR	99	76			15,6	
800215N	NEW HOLLAND	Schlepper / TS	80	76		14	15	
800215N	NEW HOLLAND	Schlepper / TS	90	76		14	15	
800215N	NEW HOLLAND	Schlepper / TS	100	76		14	15	
800215N	NEW HOLLAND	Schlepper / TS	110	76		14	15	
800215N	NEW HOLLAND	Schlepper / TS	115	76		14	15	
800279N	NEW HOLLAND	Schlepper / TSA	100A	63,5		20	20	
800279N	NEW HOLLAND	Schlepper / TSA	110A	63,5		20	20	
800279N	NEW HOLLAND	Schlepper / TSA	115A	63,5		20	20	
800279N	NEW HOLLAND	Schlepper / TSA	125A	63,5		20	20	

Dasis Nr.	Hersteller	Modell	Typ	Außendurchmesser [mm]	Länge [mm]	Innengewinde 1 [mm]	Außengewinde 1 [mm]	für OE-Nummer
800279N	NEW HOLLAND	Schlepper / TSA	135A	63,5		20	20	
800055N	NEW HOLLAND	Schlepper / TV	140	76			15,6	
800055N	NEW HOLLAND	Schlepper / TV	145	76			15,6	
800043N	NEW HOLLAND	Schlepper / TW	10	10			16	D5NN19N644A D6NN19N644B
800542N	NEW HOLLAND	Schlepper / TW	10	102			16	
800542N	NEW HOLLAND	Schlepper / TW5	5	102			16	
800542N	NEW HOLLAND	Schlepper / TW5	15	102			16	
800542N	NEW HOLLAND	Schlepper / TW5	25	102			16	
800542N	NEW HOLLAND	Schlepper / TW5	35	102			16	
800055N	NEW HOLLAND	Schlepper / TX	30	76			15,6	
800055N	NEW HOLLAND	Schlepper / TX	32	76			15,6	
800055N	NEW HOLLAND	Schlepper / TX	34	76			15,6	
800055N	NEW HOLLAND	Schlepper / TX	36	76			15,6	
800372N	NEW HOLLAND	Schlepper Wein Obst / TN	55	76				
800372N	NEW HOLLAND	Schlepper Wein Obst / TN	65	76				
800372N	NEW HOLLAND	Schlepper Wein Obst / TN	70	76				
800372N	NEW HOLLAND	Schlepper Wein Obst / TN	75	76				
800010N	NEW HOLLAND	Schlepper Wein Obst / TND	55	76		14,7	15,8	
800010N	NEW HOLLAND	Schlepper Wein Obst / TND	65	76		14,7	15,8	
800010N	NEW HOLLAND	Schlepper Wein Obst / TND	70	76		14,7	15,8	
800010N	NEW HOLLAND	Schlepper Wein Obst / TND	75	76		14,7	15,8	
800372N	NEW HOLLAND	Schlepper Wein Obst / TNF	65	76				
800372N	NEW HOLLAND	Schlepper Wein Obst / TNF	70	76				
800372N	NEW HOLLAND	Schlepper Wein Obst / TNF	75	76				
800372N	NEW HOLLAND	Schlepper Wein Obst / TNF	80	76				
800372N	NEW HOLLAND	Schlepper Wein Obst / TNF	90	76				
800372N	NEW HOLLAND	Schlepper Wein Obst / TNF	95	76				
800372N	NEW HOLLAND	Schlepper Wein Obst / TNS	55	76				
800372N	NEW HOLLAND	Schlepper Wein Obst / TNS	65	76				
800372N	NEW HOLLAND	Schlepper Wein Obst / TNS	70	76				
800372N	NEW HOLLAND	Schlepper Wein Obst / TNS	75	76				

Dasis Nr.	Hersteller	Modell	Typ	Außendurchmesser [mm]	Länge [mm]	Innengewinde 1 [mm]	Außengewinde 1 [mm]	für OE-Nummer
800542N	NEW HOLLAND	Schlepper Wein Obst / TW	5	102			16	
800542N	NEW HOLLAND	Schlepper Wein Obst / TW	15	102			16	
800542N	NEW HOLLAND	Schlepper Wein Obst / TW	25	102			16	
800542N	NEW HOLLAND	Schlepper Wein Obst / TW	30	102			16	
800542N	NEW HOLLAND	Schlepper Wein Obst / TW	35	102			16	
800155N	Renault	Schlepper / Ares 500	531S	76			16	
800155N	Renault	Schlepper / Ares 500	540	76			16	
800155N	Renault	Schlepper / Ares 500	546	76			16	
800155N	Renault	Schlepper / Ares 500	550	76			16	
800155N	Renault	Schlepper / Ares 500	556	76			16	
800155N	Renault	Schlepper / Ares 500	560	76			16	
800155N	Renault	Schlepper / Ares 500	566	76			16	
800155N	Renault	Schlepper / Ares 600	610	76			16	
800155N	Renault	Schlepper / Ares 600	616	76			16	
800155N	Renault	Schlepper / Ares 600	620	76			16	
800155N	Renault	Schlepper / Ares 600	626	76			16	
800155N	Renault	Schlepper / Ares 600	630	76			16	
800155N	Renault	Schlepper / Ares 600	636	76			16	
800155N	Renault	Schlepper / Ares 600	640	76			16	
800155N	Renault	Schlepper / Ares 600	696	76			16	
800155N	Renault	Schlepper / Ares 700	710	76			16	
800155N	Renault	Schlepper / Ares 700	715	76			16	
800155N	Renault	Schlepper / Ares 700	720	76			16	
800155N	Renault	Schlepper / Ares 700	725	76			16	
800155N	Renault	Schlepper / Ares 700	735	76			16	
800155N	Renault	Schlepper / Ares 800	815	76			16	
800155N	Renault	Schlepper / Ares 800	816	76			16	
800155N	Renault	Schlepper / Ares 800	825	76			16	
800155N	Renault	Schlepper / Ares 800	826	76			16	
800155N	Renault	Schlepper / Ares 800	836	76			16	
800155N	Renault	Schlepper / Ceres	65	76			16	

Dasis Nr.	Hersteller	Modell	Typ	Außendurchmesser [mm]	Länge [mm]	Innengewinde 1 [mm]	Außengewinde 1 [mm]	für OE-Nummer
800155N	Renault	Schlepper / Ceres	65-4	76			16	
800155N	Renault	Schlepper / Ceres	70-70	76			16	
800155N	Renault	Schlepper / Ceres	70-70-4	76			16	
800155N	Renault	Schlepper / Ceres	75-75	76			16	
800155N	Renault	Schlepper / Ceres	75-75-4	76			16	
800155N	Renault	Schlepper / Ceres	85-85	76			16	
800155N	Renault	Schlepper / Ceres	85-85-4	76			16	
800155N	Renault	Schlepper / Ceres	95-95	76			16	
800155N	Renault	Schlepper / Ceres	95-95-4	76			16	
800155N	Renault	Schlepper / Ceres	310	76			16	
800155N	Renault	Schlepper / Ceres	320	76			16	
800155N	Renault	Schlepper / Ceres	325	76			16	
800155N	Renault	Schlepper / Ceres	330	76			16	
800155N	Renault	Schlepper / Ceres	335	76			16	
800155N	Renault	Schlepper / Ceres	340	76			16	
800155N	Renault	Schlepper / Ceres	345	76			16	
800155N	Renault	Schlepper / Ceres	355	76			16	
800155N	Renault	Schlepper / Cergos	330	76			16	
800155N	Renault	Schlepper / Cergos	335	76			16	
800155N	Renault	Schlepper / Cergos	340	76			16	
800155N	Renault	Schlepper / Cergos	345	76			16	
800155N	Renault	Schlepper / Cergos	350	76			16	
800155N	Renault	Schlepper / Cergos	355	76			16	
800155N	Renault	Schlepper / Ergos	85	76			16	
800155N	Renault	Schlepper / Ergos	85-4	76			16	
800155N	Renault	Schlepper / Ergos	90	76			16	
800155N	Renault	Schlepper / Ergos	90-4	76			16	
800155N	Renault	Schlepper / Ergos	95	76			16	
800155N	Renault	Schlepper / Ergos	95-4	76			16	
800155N	Renault	Schlepper / Ergos	95-4P	76			16	
800155N	Renault	Schlepper / Ergos	95P	76			16	

Dasis Nr.	Hersteller	Modell	Typ	Außendurchmesser [mm]	Länge [mm]	Innengewinde 1 [mm]	Außengewinde 1 [mm]	für OE-Nummer
800155N	Renault	Schlepper / Ergos	100	76			16	
800155N	Renault	Schlepper / Ergos	100-4	76			16	
800155N	Renault	Schlepper / Ergos	100-4P	76			16	
800155N	Renault	Schlepper / Ergos	100-4PJVHyro	76			16	
800155N	Renault	Schlepper / Ergos	100P	76			16	
800155N	Renault	Schlepper / Ergos	100PJVHyro	76			16	
800155N	Renault	Schlepper / Ergos	105	76			16	
800155N	Renault	Schlepper / Ergos	105-4	76			16	
800155N	Renault	Schlepper / Ergos	105-4P	76			16	
800155N	Renault	Schlepper / Ergos	105P	76			16	
800155N	Renault	Schlepper / Ergos	110	76			16	
800155N	Renault	Schlepper / Ergos	110-4	76			16	
800155N	Renault	Schlepper / Ergos	110-4P	76			16	
800155N	Renault	Schlepper / Ergos	110P	76			16	
800155N	Renault	Schlepper / Ergos	436	76			16	
800155N	Renault	Schlepper / Ergos	436-4	76			16	
800155N	Renault	Schlepper / Ergos	446	76			16	
800155N	Renault	Schlepper / Ergos	446-4	76			16	
800155N	Renault	Schlepper / Ergos	446-4P	76			16	
800155N	Renault	Schlepper / Ergos	446P	76			16	
800155N	Renault	Schlepper / Ergos	456	76			16	
800155N	Renault	Schlepper / Ergos	456-4	76			16	
800155N	Renault	Schlepper / Ergos	456-4P	76			16	
800155N	Renault	Schlepper / Ergos	456P	76			16	
800155N	Renault	Schlepper / Ergos	456PJV	76			16	
800155N	Renault	Schlepper / Ergos	466	76			16	
800155N	Renault	Schlepper / Ergos	466-4	76			16	
800155N	Renault	Schlepper / Ergos	466-4P	76			16	
800155N	Renault	Schlepper / Ergos	466P	76			16	
801100N	Renault	Schlepper / ME	58-32ME	51			10	
801100N	Renault	Schlepper / ME	58-34ME	51			10	

Dasis Nr.	Hersteller	Modell	Typ	Außendurchmesser [mm]	Länge [mm]	Innengewinde 1 [mm]	Außengewinde 1 [mm]	für OE-Nummer
801100N	Renault	Schlepper / ME	65-32ME	51			10	
801100N	Renault	Schlepper / ME	65-34ME	51			10	
801100N	Renault	Schlepper / ME	75-12ME	51			10	
801100N	Renault	Schlepper / ME	75-32ME	51			10	
801100N	Renault	Schlepper / ME	75-34ME	51			10	
801100N	Renault	Schlepper / ME	85-32ME	51			10	
801100N	Renault	Schlepper / ME	85-34ME	51			10	
801100N	Renault	Schlepper / ME	90-32ME	51			10	
801100N	Renault	Schlepper / ME	90-34ME	51			10	
801100N	Renault	Schlepper / ME	110-14ME	51			10	
801100N	Renault	Schlepper / ME	120-14ME	51			10	
801100N	Renault	Schlepper / ME	133-14ME	51			10	
801100N	Renault	Schlepper / ME	145-14ME	51			10	
800049N	Renault	Schlepper / MI	650	76			16	
800049N	Renault	Schlepper / MI	750	76			16	
800049N	Renault	Schlepper / MI	754	76			16	
800049N	Renault	Schlepper / MI	850	76			16	
800049N	Renault	Schlepper / MI	854	76			16	
800049N	Renault	Schlepper / MI	900	76			16	
800049N	Renault	Schlepper / MI	904	76			16	
800049N	Renault	Schlepper / MI	950	76			16	
800049N	Renault	Schlepper / MI	954	76			16	
801100N	Renault	Schlepper / RE	95-12RE	51			10	
801100N	Renault	Schlepper / RE	95-14RE	51			10	
801100N	Renault	Schlepper / RE	103-12RE	51			10	
801100N	Renault	Schlepper / RE	103-14RE	51			10	
801100N	Renault	Schlepper / RE	110-14RE	51			10	
801100N	Renault	Schlepper / RE	113-12RE	51			10	
801100N	Renault	Schlepper / RE	113-14RE	51			10	
801100N	Renault	Schlepper / RE	120-14RE	51			10	
801100N	Renault	Schlepper / RE	133-14RE	51			10	

Dasis Nr.	Hersteller	Modell	Typ	Außendurchmesser [mm]	Länge [mm]	Innengewinde 1 [mm]	Außengewinde 1 [mm]	für OE-Nummer
801100N	Renault	Schlepper / RE	145-14RE	51			10	
801100N	Renault	Schlepper / RS	61-12	51			10	
801100N	Renault	Schlepper / RS	61-14	51			10	
801100N	Renault	Schlepper / RS	68-12	51			10	
801100N	Renault	Schlepper / RS	68-14	51			10	
801100N	Renault	Schlepper / RS	75-12	51			10	
801100N	Renault	Schlepper / RS	75-14	51			10	
801100N	Renault	Schlepper / RS	95-12	51			10	
801100N	Renault	Schlepper / RS	95-14	51			10	
801100N	Renault	Schlepper / RS	103-12	51			10	
801100N	Renault	Schlepper / RS	103-14	51			10	
800155N	Renault	Schlepper / RX	531S	76			16	
800155N	Renault	Schlepper / RX	540	76			16	
800155N	Renault	Schlepper / RX	550	76			16	
800155N	Renault	Schlepper / RX	610	76			16	
800155N	Renault	Schlepper / RX	620	76			16	
800155N	Renault	Schlepper / RX	630	76			16	
800155N	Renault	Schlepper / RZ	610	76			16	
800155N	Renault	Schlepper / RZ	620	76			16	
800155N	Renault	Schlepper / RZ	630	76			16	
800155N	Renault	Schlepper / RZ	640	76			16	
800155N	Renault	Schlepper / RZ	710	76			16	
800155N	Renault	Schlepper / RZ	720	76			16	
800155N	Renault	Schlepper / RZ	725	76			16	
800155N	Renault	Schlepper / RZ	735	76			16	
800155N	Renault	Schlepper / RZ	815	76			16	
800155N	Renault	Schlepper / RZ	825	76			16	
801100N	Renault	Schlepper / SP	70-12SP	51			10	
801100N	Renault	Schlepper / SP	70-14SP	51			10	
801100N	Renault	Schlepper / SP	80-12SP	51			10	
801100N	Renault	Schlepper / SP	80-14SP	51			10	

Dasis Nr.	Hersteller	Modell	Typ	Außendurchmesser [mm]	Länge [mm]	Innengewinde 1 [mm]	Außengewinde 1 [mm]	für OE-Nummer
801100N	Renault	Schlepper / SP	106-14SP	51			10	
801100N	Renault	Schlepper / TA	103-52	51			10	
800155N	Renault	Schlepper / TA	103-52	76			16	
801100N	Renault	Schlepper / TA	103-54	51			10	
800155N	Renault	Schlepper / TA	103-54	76			16	
801100N	Renault	Schlepper / TA	110-14	51			10	
800155N	Renault	Schlepper / TA	110-14	76			16	
801100N	Renault	Schlepper / TA	110-54	51			10	
800155N	Renault	Schlepper / TA	110-54	76			16	
801100N	Renault	Schlepper / TA	120-14	51			10	
800155N	Renault	Schlepper / TA	120-14	76			16	
801100N	Renault	Schlepper / TA	120-54	51			10	
800155N	Renault	Schlepper / TA	120-54	76			16	
801100N	Renault	Schlepper / TA	133-14	51			10	
800155N	Renault	Schlepper / TA	133-14	76			16	
801100N	Renault	Schlepper / TA	133-54	51			10	
800155N	Renault	Schlepper / TA	133-54	76			16	
801100N	Renault	Schlepper / TA	145-14	51			10	
800155N	Renault	Schlepper / TA	145-14	76			16	
801100N	Renault	Schlepper / TA	145-54	51			10	
800155N	Renault	Schlepper / TA	145-54	76			16	
801100N	Renault	Schlepper / TA	155-54	51			10	
800155N	Renault	Schlepper / TA	155-54	76			16	
801100N	Renault	Schlepper / TE	103-52TE	51			10	
800155N	Renault	Schlepper / TE	103-52TE	76			16	
801100N	Renault	Schlepper / TE	103-54TE	51			10	
800155N	Renault	Schlepper / TE	103-54TE	76			16	
801100N	Renault	Schlepper / TE	110-14TE	51			10	
800155N	Renault	Schlepper / TE	110-14TE	76			16	
801100N	Renault	Schlepper / TE	110-54TE	51			10	
800155N	Renault	Schlepper / TE	110-54TE	76			16	



Dasis Nr.	Hersteller	Modell	Typ	Außendurchmesser [mm]	Länge [mm]	Innengewinde 1 [mm]	Außengewinde 1 [mm]	für OE-Nummer
801100N	Renault	Schlepper / TE	120-14TE	51			10	
801100N	Renault	Schlepper / TE	120-54TE	51			10	
801100N	Renault	Schlepper / TE	133-14TE	51			10	
801100N	Renault	Schlepper / TE	133-54TE	51			10	
801100N	Renault	Schlepper / TE	145-14TE	51			10	
800155N	Renault	Schlepper / TE	145-14TE	76			16	
801100N	Renault	Schlepper / TE	145-54TE	51			10	
800155N	Renault	Schlepper / TE	145-54TE	76			16	
801100N	Renault	Schlepper / TE	155-54TE	51			10	
800155N	Renault	Schlepper / TE	155-54TE	76			16	
801100N	Renault	Schlepper / TL	106-54	51			10	
800155N	Renault	Schlepper / TL	106-54	76			16	
801100N	Renault	Schlepper / TS	75-12	51			10	
800155N	Renault	Schlepper / TS	75-12	76			16	
801100N	Renault	Schlepper / TS	75-14	51			10	
800155N	Renault	Schlepper / TS	75-14	76			16	
801100N	Renault	Schlepper / TS	77-12	51			10	
800155N	Renault	Schlepper / TS	77-12	76			16	
801100N	Renault	Schlepper / TS	77-14	51			10	
800155N	Renault	Schlepper / TS	77-14	76			16	
801100N	Renault	Schlepper / TS	85-12	51			10	
800155N	Renault	Schlepper / TS	85-12	76			16	
801100N	Renault	Schlepper / TS	85-14	51			10	
800155N	Renault	Schlepper / TS	85-14	76			16	
801100N	Renault	Schlepper / TS	95-12	51			10	
800155N	Renault	Schlepper / TS	95-12	76			16	
801100N	Renault	Schlepper / TS	95-14	51			10	
800155N	Renault	Schlepper / TS	95-14	76			16	
801100N	Renault	Schlepper / TS	103-12	51			10	
800155N	Renault	Schlepper / TS	103-12	76			16	
801100N	Renault	Schlepper / TS	103-14	51			10	

Dasis Nr.	Hersteller	Modell	Typ	Außendurchmesser [mm]	Länge [mm]	Innengewinde 1 [mm]	Außengewinde 1 [mm]	für OE-Nummer
800155N	Renault	Schlepper / TS	103-14	76			16	
801100N	Renault	Schlepper / TS	103-52	51			10	
800155N	Renault	Schlepper / TS	103-52	76			16	
801100N	Renault	Schlepper / TS	103-54	51			10	
800155N	Renault	Schlepper / TS	103-54	76			16	
801100N	Renault	Schlepper / TS	106-54	51			10	
800155N	Renault	Schlepper / TS	106-54	76			16	
801100N	Renault	Schlepper / TS	110-14	51			10	
800155N	Renault	Schlepper / TS	110-14	76			16	
801100N	Renault	Schlepper / TS	110-54	51			10	
800155N	Renault	Schlepper / TS	110-54	76			16	
801100N	Renault	Schlepper / TS	113-12	51			10	
800155N	Renault	Schlepper / TS	113-12	76			16	
801100N	Renault	Schlepper / TS	113-14	51			10	
800155N	Renault	Schlepper / TS	113-14	76			16	
801100N	Renault	Schlepper / TS	120-14	51			10	
800155N	Renault	Schlepper / TS	120-14	76			16	
801100N	Renault	Schlepper / TS	120-54	51			10	
800155N	Renault	Schlepper / TS	120-54	76			16	
801100N	Renault	Schlepper / TS	133-12	51			10	
800155N	Renault	Schlepper / TS	133-12	76			16	
801100N	Renault	Schlepper / TS	133-14	51			10	
800155N	Renault	Schlepper / TS	133-14	76			16	
801100N	Renault	Schlepper / TS	133-54	51			10	
800155N	Renault	Schlepper / TS	133-54	76			16	
801100N	Renault	Schlepper / TX	75-32TX	51			10	
800155N	Renault	Schlepper / TX	75-32TX	76			16	
801100N	Renault	Schlepper / TX	75-34TX	51			10	
800155N	Renault	Schlepper / TX	75-34TX	76			16	
801100N	Renault	Schlepper / TX	80-12TX	51			10	
800155N	Renault	Schlepper / TX	80-12TX	76			16	

Dasis Nr.	Hersteller	Modell	Typ	Außendurchmesser [mm]	Länge [mm]	Innengewinde 1 [mm]	Außengewinde 1 [mm]	für OE-Nummer
801100N	Renault	Schlepper / TX	80-14TX	51			10	
800155N	Renault	Schlepper / TX	80-14TX	76			16	
801100N	Renault	Schlepper / TX	85-12TX	51			10	
800155N	Renault	Schlepper / TX	85-12TX	76			16	
801100N	Renault	Schlepper / TX	85-14TX	51			10	
800155N	Renault	Schlepper / TX	85-14TX	76			16	
801100N	Renault	Schlepper / TX	85-32TX	51			10	
800155N	Renault	Schlepper / TX	85-32TX	76			16	
801100N	Renault	Schlepper / TX	85-34TX	51			10	
800155N	Renault	Schlepper / TX	85-34TX	76			16	
801100N	Renault	Schlepper / TX	90-32TX	51			10	
800155N	Renault	Schlepper / TX	90-32TX	76			16	
801100N	Renault	Schlepper / TX	90-34TX	51			10	
800155N	Renault	Schlepper / TX	90-34TX	76			16	
801100N	Renault	Schlepper / TX	95-12TX	51			10	
800155N	Renault	Schlepper / TX	95-12TX	76			16	
801100N	Renault	Schlepper / TX	95-14TX	51			10	
800155N	Renault	Schlepper / TX	95-14TX	76			16	
801100N	Renault	Schlepper / TX	103-12TX	51			10	
800155N	Renault	Schlepper / TX	103-12TX	76			16	
801100N	Renault	Schlepper / TX	103-14TX	51			10	
800155N	Renault	Schlepper / TX	103-14TX	76			16	
801100N	Renault	Schlepper / TX	103-52TX	51			10	
800155N	Renault	Schlepper / TX	103-52TX	76			16	
801100N	Renault	Schlepper / TX	103-54TX	51			10	
800155N	Renault	Schlepper / TX	103-54TX	76			16	
801100N	Renault	Schlepper / TX	106-54TX	51			10	
800155N	Renault	Schlepper / TX	106-54TX	76			16	
801100N	Renault	Schlepper / TX	110-14TX	51			10	
800155N	Renault	Schlepper / TX	110-14TX	76			16	
801100N	Renault	Schlepper / TX	110-54TX	51			10	

Dasis Nr.	Hersteller	Modell	Typ	Außendurchmesser [mm]	Länge [mm]	Innengewinde 1 [mm]	Außengewinde 1 [mm]	für OE-Nummer
800155N	Renault	Schlepper / TX	110-54TX	76			16	
801100N	Renault	Schlepper / TX	113-12TX	51			10	
800155N	Renault	Schlepper / TX	113-12TX	76			16	
801100N	Renault	Schlepper / TX	113-14TX	51			10	
800155N	Renault	Schlepper / TX	113-14TX	76			16	
801100N	Renault	Schlepper / TX	120-14TX	51			10	
800155N	Renault	Schlepper / TX	120-14TX	76			16	
801100N	Renault	Schlepper / TX	120-54TX	51			10	
800155N	Renault	Schlepper / TX	120-54TX	76			16	
801100N	Renault	Schlepper / TX	133-12TX	51			10	
800155N	Renault	Schlepper / TX	133-12TX	76			16	
801100N	Renault	Schlepper / TX	133-14TX	51			10	
800155N	Renault	Schlepper / TX	133-14TX	76			16	
801100N	Renault	Schlepper / TX	133-54TX	51			10	
800155N	Renault	Schlepper / TX	133-54TX	76			16	
801100N	Renault	Schlepper / TX	145-14TX	51			10	
800155N	Renault	Schlepper / TX	145-14TX	76			16	
801100N	Renault	Schlepper / TX	145-54TX	51			10	
800155N	Renault	Schlepper / TX	145-54TX	76			16	
801100N	Renault	Schlepper / TX	155-54TX	51			10	
800155N	Renault	Schlepper / TX	155-54TX	76			16	
801100N	Renault	Schlepper / TZ	110-54TZ	51			10	
800155N	Renault	Schlepper / TZ	110-54TZ	76			16	
801100N	Renault	Schlepper / TZ	120-14TZ	51			10	
800155N	Renault	Schlepper / TZ	120-14TZ	76			16	
801100N	Renault	Schlepper / TZ	120-54TZ	51			10	
800155N	Renault	Schlepper / TZ	120-54TZ	76			16	
801100N	Renault	Schlepper / TZ	133-14TZ	51			10	
800155N	Renault	Schlepper / TZ	133-14TZ	76			16	
801100N	Renault	Schlepper / TZ	133-54TZ	51			10	
800155N	Renault	Schlepper / TZ	133-54TZ	76			16	

Dasis Nr.	Hersteller	Modell	Typ	Außendurchmesser [mm]	Länge [mm]	Innengewinde 1 [mm]	Außengewinde 1 [mm]	für OE-Nummer
801100N	Renault	Schlepper / TZ	145-14TZ	51			10	
800155N	Renault	Schlepper / TZ	145-14TZ	76			16	
801100N	Renault	Schlepper / TZ	145-54TZ	51			10	
800155N	Renault	Schlepper / TZ	145-54TZ	76			16	
801100N	Renault	Schlepper / TZ	155-54TZ	51			10	
800155N	Renault	Schlepper / TZ	155-54TZ	76			16	
801100N	Renault	Schlepper / TZ	160-94TZ	51			10	
800155N	Renault	Schlepper / TZ	160-94TZ	76			16	
801100N	Renault	Schlepper / TZ	175-74TZ	51			10	
800155N	Renault	Schlepper / TZ	175-74TZ	76			16	
801100N	Renault	Schlepper / TZ	180-94TZ	51			10	
800155N	Renault	Schlepper / TZ	180-94TZ	76			16	
800010N	Renault	Schlepper Obst Wein / Dionis	110	76		14,7	15,8	
800010N	Renault	Schlepper Obst Wein / Dionis	120	76		14,7	15,8	
800010N	Renault	Schlepper Obst Wein / Dionis	130	76		14,7	15,8	
800010N	Renault	Schlepper Obst Wein / Dionis	140	76		14,7	15,8	
800010N	Renault	Schlepper Obst Wein / Fructus	110	76		14,7	15,8	
800010N	Renault	Schlepper Obst Wein / Fructus	120	76		14,7	15,8	
800010N	Renault	Schlepper Obst Wein / Fructus	130	76		14,7	15,8	
800010N	Renault	Schlepper Obst Wein / Fructus	140	76		14,7	15,8	
801100N	Renault	Schlepper Obst Wein / TZ	160-94	51			10	
801100N	Renault	Schlepper Obst Wein / TZ	175-74	51			10	
801100N	Renault	Schlepper Obst Wein / TZ	180-94	51			10	
800154N	Same	Schlepper / Rubin	120	62				
800154N	Same	Schlepper / Rubin	135	62				
800154N	Same	Schlepper / Rubin	150	62				
800154N	Same	Schlepper / Rubin	160	62				
800154N	Same	Schlepper / Rubin	180	62				

Dasis Nr.	Hersteller	Modell	Typ	Außendurchmesser [mm]	Länge [mm]	Innengewinde 1 [mm]	Außengewinde 1 [mm]	für OE-Nummer
800154N	Same	Schlepper / Rubin	200	62				
800010N	Same	Schlepper / Silver	80	76		14,7	15,8	
800010N	Same	Schlepper / Silver	85	76		14,7	15,8	
800010N	Same	Schlepper / Silver	90	76		14,7	15,8	
800010N	Same	Schlepper / Silver	95	76		14,7	15,8	
800010N	Same	Schlepper / Silver	100.4	76		14,7	15,8	
800010N	Same	Schlepper / Silver	100.6	76		14,7	15,8	
800010N	Same	Schlepper / Silver	105	76		14,7	15,8	
800010N	Same	Schlepper / Silver	110	76		14,7	15,8	
800010N	Same	Schlepper / Silver	115	76		14,7	15,8	
800010N	Same	Schlepper / Silver	130	76		14,7	15,8	
800010N	Same	Schlepper / Silver	160	76		14,7	15,8	
800010N	Same	Schlepper / Silver	180	76		14,7	15,8	
800679N	Steyr	Schlepper / 4000	4055S					47530212
800679N	Steyr	Schlepper / 4000	4065S					47530212
800677N	Steyr	Schlepper / 4000	4075 Kompakt	10				47465067 47465072
800677N	Steyr	Schlepper / 4000	4085 Kompakt	10				47465067 47465072
800677N	Steyr	Schlepper / 4000	4095 Multi	10				47465067 47465072
800677N	Steyr	Schlepper / 4000	4100	10				47465067 47465072
800677N	Steyr	Schlepper / 4000	4105 Kompakt	10				47465067 47465072
800677N	Steyr	Schlepper / 4000	4105 Multi	10				47465067 47465072
800677N	Steyr	Schlepper / 4000	4110	10				47465067 47465072
800677N	Steyr	Schlepper / 4000	4115 Kompakt	10				47465067 47465072
800677N	Steyr	Schlepper / 4000	4115 Multi	10				47465067 47465072
800677N	Steyr	Schlepper / 4000	4120	10				47465067 47465072
800064N	Steyr	Schlepper / 9000	9105	76			16	
800064N	Steyr	Schlepper / 9000	9115	76			16	
800064N	Steyr	Schlepper / 9000	9125	76			16	
800064N	Steyr	Schlepper / 9000	9145	76			16	
800064N	Steyr	Schlepper / 9000	9155	76			16	
800064N	Steyr	Schlepper / CS	78	76			16	

Dasis Nr.	Hersteller	Modell	Typ	Außendurchmesser [mm]	Länge [mm]	Innengewinde 1 [mm]	Außengewinde 1 [mm]	für OE-Nummer
800064N	Steyr	Schlepper / CS	86	76			16	
800064N	Steyr	Schlepper / CS	94	76			16	
800064N	Steyr	Schlepper / CS	100	76			16	
800064N	Steyr	Schlepper / CS	110	76			16	
800064N	Steyr	Schlepper / CS	120	76			16	
800064N	Steyr	Schlepper / CS	130	76			16	
800064N	Steyr	Schlepper / CS	150	76			16	
800064N	Steyr	Schlepper / CVX	V120	76			16	
800064N	Steyr	Schlepper / CVX	V130	76			16	
800064N	Steyr	Schlepper / CVX	V150	76			16	
800064N	Steyr	Schlepper / CVX	V170	76			16	
800064N	Steyr	Schlepper / CVX	V1135	76			16	
800064N	Steyr	Schlepper / CVX	V1145	76			16	
800064N	Steyr	Schlepper / CVX	V1155	76			16	
800064N	Steyr	Schlepper / CVX	V1170	76			16	
800064N	Steyr	Schlepper / CVX	V1190	76			16	
800534N	Timberjack	Forstmaschiene / 810-1710	810	76			16	
800534N	Timberjack	Forstmaschiene / 810-1710	1110	76			16	
800534N	Timberjack	Forstmaschiene / 810-1710	1410	76			16	
800534N	Timberjack	Forstmaschiene / 810-1710	1710	76			16	
800534N	Timberjack	Schlepper / 770-1470	770	76			16	
800534N	Timberjack	Schlepper / 770-1470	1070	76			16	
800534N	Timberjack	Schlepper / 770-1470	1270	76			16	
800534N	Timberjack	Schlepper / 770-1470	1470	76			16	
800055N	Valtra Valmet	Schlepper / 6000	6000	76			15,6	
800201N	Valtra Valmet	Schlepper / 6000	6100	76			10	
800055N	Valtra Valmet	Schlepper / 6000	6200	76			15,6	
800201N	Valtra Valmet	Schlepper / 6000	6300	76			10	
800201N	Valtra Valmet	Schlepper / 6000	6400	76			10	
800201N	Valtra Valmet	Schlepper / 6000	6600	76			10	
800055N	Valtra Valmet	Schlepper / 6000	6800	76			15,6	

Dasis Nr.	Hersteller	Modell	Typ	Außendurchmesser [mm]	Länge [mm]	Innengewinde 1 [mm]	Außengewinde 1 [mm]	für OE-Nummer
800055N	Valtra Valmet	Schlepper / 6000	6900	76			15,6	
800201N	Valtra Valmet	Schlepper / 8000	8000	76			10	
800534N	Valtra Valmet	Schlepper / 8000	8050	76			16	
800201N	Valtra Valmet	Schlepper / 8000	8100	76			10	
800534N	Valtra Valmet	Schlepper / 8000	8150	76			16	
800055N	Valtra Valmet	Schlepper / 8000	8200	76			15,6	
800201N	Valtra Valmet	Schlepper / 8000	8300	76			10	
800055N	Valtra Valmet	Schlepper / 8000	8300T	76			15,6	
800055N	Valtra Valmet	Schlepper / 8000	8400	76			15,6	
800534N	Valtra Valmet	Schlepper / 8000	8450	76			16	
800534N	Valtra Valmet	Schlepper / 8000	8550	76			16	
800201N	Valtra Valmet	Schlepper / 8000	8600	76			10	
800534N	Valtra Valmet	Schlepper / 8000	8750	76			16	
800055N	Valtra Valmet	Schlepper / 8000	8800	76			15,6	
802110N	Valtra Valmet	Schlepper / A	85	63,5			11	
802110N	Valtra Valmet	Schlepper / A	120	63,5			11	
802110N	Valtra Valmet	Schlepper / A	120E	63,5			11	
800055N	Valtra Valmet	Schlepper / HI	6250	76			15,6	
800055N	Valtra Valmet	Schlepper / HI	6550	76			15,6	
800055N	Valtra Valmet	Schlepper / HI	6650	76			15,6	
800055N	Valtra Valmet	Schlepper / HI	6850	76			15,6	
802110N	Valtra Valmet	Schlepper / M	120	63,5			11	
800963N	Valtra Valmet	Schlepper / N	93	35	267			63228900 V63228900
800963N	Valtra Valmet	Schlepper / N	103	35	267			63228900 V63228900
800963N	Valtra Valmet	Schlepper / N	113	35	267			63228900 V63228900
802110N	Valtra Valmet	Schlepper / N	121	63,5			11	
800963N	Valtra Valmet	Schlepper / N	123	35	267			63228900 V63228900
800963N	Valtra Valmet	Schlepper / N	143	35	267			63228900 V63228900
800963N	Valtra Valmet	Schlepper / N	163	35	267			63228900 V63228900
800055N	Valtra Valmet	Schlepper / S	230	76			15,6	
800055N	Valtra Valmet	Schlepper / S	240	76			15,6	



Dasis Nr.	Hersteller	Modell	Typ	Außendurchmesser [mm]	Länge [mm]	Innengewinde 1 [mm]	Außengewinde 1 [mm]	für OE-Nummer
800055N	Valtra Valmet	Schlepper / S	260	76			15,6	
800055N	Valtra Valmet	Schlepper / S	280	76			15,6	
802110N	Valtra Valmet	Schlepper / T	130	63,5			11	
800963N	Valtra Valmet	Schlepper / T	133	35	267			63228900 V63228900
800963N	Valtra Valmet	Schlepper / T	153	35	267			63228900 V63228900
802110N	Valtra Valmet	Schlepper / T	160	63,5			11	
800963N	Valtra Valmet	Schlepper / T	163	35	267			63228900 V63228900
800963N	Valtra Valmet	Schlepper / T	173	35	267			63228900 V63228900
802110N	Valtra Valmet	Schlepper / T	180	63,5			11	
800963N	Valtra Valmet	Schlepper / T	183	35	267			63228900 V63228900
802110N	Valtra Valmet	Schlepper / T	190	63,5			11	
800963N	Valtra Valmet	Schlepper / T	193	35	267			63228900 V63228900
800963N	Valtra Valmet	Schlepper / T	203	35	267			63228900 V63228900
800963N	Valtra Valmet	Schlepper / T	213	35	267			63228900 V63228900
801580N	Volvo	Bagger 360 ° / 6000	6300	89		17,7		
802240N	Volvo	Bagger 360 ° / B	EC200	76		5	10	
801010N	Volvo	Bagger 360 ° / B	EC200	76		8	15	
802240N	Volvo	Bagger 360 ° / B	EC300	76		5	10	
801010N	Volvo	Bagger 360 ° / B	EC300	76		8	15	
801720N	Volvo	Baggerlader / 600	616B					
801720N	Volvo	Baggerlader / 600	646					
802300N	Volvo	Baggerlader / 4300-4000	4200	76				
802300N	Volvo	Baggerlader / 4300-4000	4300	76				
801010N	Volvo	Motorgrader / C	A25C	76		8	15	
801010N	Volvo	Motorgrader / C	A30C	76		8	15	
801010N	Volvo	Motorgrader / C	A40C	76		8	15	
801010N	Volvo	Muldenkipper / B	EC200	76		8	15	
801010N	Volvo	Muldenkipper / B	EC300	76		8	15	
802240N	Volvo	Muldenkipper / C	A250	76		5	10	
802240N	Volvo	Muldenkipper / C	A300	76		5	10	
802240N	Volvo	Muldenkipper / C	A400	76		5	10	

Dasis Nr.	Hersteller	Modell	Typ	Außendurchmesser [mm]	Länge [mm]	Innengewinde 1 [mm]	Außengewinde 1 [mm]	für OE-Nummer
800201N	Volvo	Schaufellader / 2600	2650	76			10	
800201N	Volvo	Schaufellader / 2600	2654	76			10	
800547N	Volvo	Schaufellader / L	50					
802300N	Volvo	Schaufellader / L	50	76				
801010N	Volvo	Schaufellader / L	50	76		8	15	
801580N	Volvo	Schaufellader / L	50	89		17,7		
801010N	Volvo	Schaufellader / L	70	76		8	15	
801580N	Volvo	Schaufellader / L	70	89		17,7		
801010N	Volvo	Schaufellader / L	90	76		8	15	
801580N	Volvo	Schaufellader / L	90	89		17,7		
801010N	Volvo	Schaufellader / L	120	76		8	15	
801580N	Volvo	Schaufellader / L	120	89		17,7		
802310N	Volvo	Schaufellader / L	160	75			15	1 089 855
801010N	Volvo	Schaufellader / L	170	76		8	15	
801580N	Volvo	Schaufellader / L	170	89		17,7		
800201N	Volvo	Schlepper / 2000-2654	2005	76			10	
800201N	Volvo	Schlepper / 2000-2654	2105	76			10	
802300N	Volvo	Schlepper / 2000-2654	2650	76				
802300N	Volvo	Schlepper / 2000-2654	2654	76				

Dasis Nr.	Hersteller	Modell	Typ	Bj von	Bj bis	PS	ccmTech	Netzlänge [mm]	Netzbreite [mm]	Netztiefe [mm]	Ausstattungsvariante	Einlass-Ø [mm]	Auslass-Ø [mm]	Einbaudicke [mm]	für OE-Nummer
820083N	Bateman	Selbstfahrende Farbspritze / RB	15			0	0								
820083N	Bateman	Selbstfahrende Farbspritze / RB	16			0	0								
820083N	Bateman	Selbstfahrende Farbspritze / RB	25			0	0								
820992N	Case International IHC	Baggerlader	580SR			0	0	325	229	73					
820992N	Case International IHC	Baggerlader	590SR			0	0	325	229	73					
820992N	Case International IHC	Baggerlader	695SM			0	0	325	229	73					
820992N	Case International IHC	Baggerlader	695SR			0	0	325	229	73					
821894N	Case International IHC	Mähdrescher / 23	2366			0	0	445	203	11					
821894N	Case International IHC	Mähdrescher / 23	2388			0	0	445	203	11					
821894N	Case International IHC	Mähdrescher / 25	2588			0	0	445	203	11					
821894N	Case International IHC	Mähdrescher / 50	5088			0	0	445	203	11					
821894N	Case International IHC	Mähdrescher / 60	6088			0	0	445	203	11					
821894N	Case International IHC	Mähdrescher / 70	7088			0	0	445	203	11					
820179N	Case International IHC	Mähdrescher / A	8000			0	0	635	152	64					87541273
820179N	Case International IHC	Mähdrescher / A	8800			0	0	635	152	64					87541273

Dasis Nr.	Hersteller	Modell	Typ	Bj von	Bj bis	PS	ccmTech	Netzlänge [mm]	Netzbreite [mm]	Netztiefe [mm]	Ausstattungsvariante	Einlass-Ø [mm]	Auslass-Ø [mm]	Einbaudicke [mm]	für OE-Nummer
820299N	Case International IHC	Schlepper / 186-996	595			0	0	394	179	79					
820299N	Case International IHC	Schlepper / 186-996	695			0	0	394	179	79					
820299N	Case International IHC	Schlepper / 186-996	795			0	0	394	179	79					
820299N	Case International IHC	Schlepper / 186-996	856			0	0	394	179	79					
820299N	Case International IHC	Schlepper / 186-996	895			0	0	394	179	79					
820299N	Case International IHC	Schlepper / 186-996	955			0	0	394	179	79					
820299N	Case International IHC	Schlepper / 186-996	956			0	0	394	179	79					
820299N	Case International IHC	Schlepper / 186-996	995			0	0	394	179	79					
820299N	Case International IHC	Schlepper / 1046-1896	1055			0	0	394	179	79					
820299N	Case International IHC	Schlepper / 1046-1896	1056			0	0	394	179	79					
820299N	Case International IHC	Schlepper / 1046-1896	1255			0	0	394	179	79					
820299N	Case International IHC	Schlepper / 1046-1896	1455			0	0	394	179	79					
820301N	Case International IHC	Schlepper / 4000-4894	4210			0	0	390	180	143					130451A1
820301N	Case International IHC	Schlepper / 4000-4894	4220			0	0	390	180	143					130451A1

Dasis Nr.	Hersteller	Modell	Typ	Bj von	Bj bis	PS	ccmTech	Netzlänge [mm]	Netzbreite [mm]	Netztiefe [mm]	Ausstattungsvariante	Einlass-Ø [mm]	Auslass-Ø [mm]	Einbaudicke [mm]	für OE-Nummer
820301N	Case International IHC	Schlepper / 4000-4894	4230			0	0	390	180	143					130451A1
820301N	Case International IHC	Schlepper / 4000-4894	4240			0	0	390	180	143					130451A1
820298N	Case International IHC	Schlepper / 5088-5488	5120			0	0	775	127	133	Block Type				
820298N	Case International IHC	Schlepper / 5088-5488	5130			0	0	775	127	133	Block Type				
820298N	Case International IHC	Schlepper / 5088-5488	5140			0	0	775	127	133	Block Type				
820298N	Case International IHC	Schlepper / 5088-5488	5150			0	0	775	127	133	Block Type				
820298N	Case International IHC	Schlepper / 7110-7488	7210			0	0	775	127	133	Block Type				
820298N	Case International IHC	Schlepper / 7110-7488	7220			0	0	775	127	133	Block Type				
820298N	Case International IHC	Schlepper / 7110-7488	7230			0	0	775	127	133	Block Type				
820298N	Case International IHC	Schlepper / 7110-7488	7240			0	0	775	127	133	Block Type				
820298N	Case International IHC	Schlepper / 7110-7488	7250			0	0	775	127	133	Block Type				
820425N	Case International IHC	Schlepper / 9110-9390	9210			0	0	445	203	95					606677T1
820425N	Case International IHC	Schlepper / 9110-9390	9230			0	0	445	203	95					606677T1
820425N	Case International IHC	Schlepper / 9110-9390	9240			0	0	445	203	95					606677T1

Dasis Nr.	Hersteller	Modell	Typ	Bj von	Bj bis	PS	ccmTech	Netzlänge [mm]	Netzbreite [mm]	Netztiefe [mm]	Ausstattungsvariante	Einlass-Ø [mm]	Auslass-Ø [mm]	Einbaudicke [mm]	für OE-Nummer
820425N	Case International IHC	Schlepper / 9110-9390	9250			0	0	445	203	95					606677T1
820425N	Case International IHC	Schlepper / 9110-9390	9260			0	0	445	203	95					606677T1
820425N	Case International IHC	Schlepper / 9110-9390	9270			0	0	445	203	95					606677T1
820425N	Case International IHC	Schlepper / 9110-9390	9280			0	0	445	203	95					606677T1
820425N	Case International IHC	Schlepper / 9110-9390	9310			0	0	445	203	95					606677T1
820425N	Case International IHC	Schlepper / 9110-9390	9330			0	0	445	203	95					606677T1
820425N	Case International IHC	Schlepper / 9110-9390	9350			0	0	445	203	95					606677T1
820425N	Case International IHC	Schlepper / 9110-9390	9370			0	0	445	203	95					606677T1
820425N	Case International IHC	Schlepper / 9110-9390	9380			0	0	445	203	95					606677T1
820425N	Case International IHC	Schlepper / 9110-9390	9390			0	0	445	203	95					606677T1
821887N	Case International IHC	Schlepper / CS	80			0	0	390	127	76					134784255
821887N	Case International IHC	Schlepper / CS	85			0	0	390	127	76					134784255
821887N	Case International IHC	Schlepper / CS	90			0	0	390	127	76					134784255
821887N	Case International IHC	Schlepper / CS	95			0	0	390	127	76					134784255

Dasis Nr.	Hersteller	Modell	Typ	Bj von	Bj bis	PS	ccmTech	Netzlänge [mm]	Netzbreite [mm]	Netztiefe [mm]	Ausstattungsvariante	Einlass-Ø [mm]	Auslass-Ø [mm]	Einbaudicke [mm]	für OE-Nummer
821887N	Case International IHC	Schlepper / CS	100			0	0	390	127	76					134784255
821887N	Case International IHC	Schlepper / CS	105			0	0	390	127	76					134784255
821887N	Case International IHC	Schlepper / CVX	140			0	0	390	127	76					134784255
821887N	Case International IHC	Schlepper / CVX	150			0	0	390	127	76					134784255
821887N	Case International IHC	Schlepper / CVX	160			0	0	390	127	76					134784255
821887N	Case International IHC	Schlepper / CVX	175			0	0	390	127	76					134784255
821887N	Case International IHC	Schlepper / CVX	195			0	0	390	127	76					134784255
820295N	Case International IHC	Schlepper / CX	50			0	0	514	152	70					372500A1
820295N	Case International IHC	Schlepper / CX	60			0	0	514	152	70					372500A1
820295N	Case International IHC	Schlepper / CX	70			0	0	514	152	70					372500A1
820295N	Case International IHC	Schlepper / CX	80			0	0	514	152	70					372500A1
820295N	Case International IHC	Schlepper / CX	90			0	0	514	152	70					372500A1
820295N	Case International IHC	Schlepper / CX	100			0	0	514	152	70					372500A1
821893N	Case International IHC	Schlepper / Farmall N Serie	75N			0	0	330	133	83					47134607

Dasis Nr.	Hersteller	Modell	Typ	Bj von	Bj bis	PS	ccmTech	Netzlänge [mm]	Netzbreite [mm]	Netztiefe [mm]	Ausstattungsvariante	Einlass-Ø [mm]	Auslass-Ø [mm]	Einbaudicke [mm]	für OE-Nummer
821893N	Case International IHC	Schlepper / Farmall N Serie	85N			0	0	330	133	83					47134607
821893N	Case International IHC	Schlepper / Farmall N Serie	95N			0	0	330	133	83					47134607
820284N	Case International IHC	Schlepper / JX	55			0	0	648	127	79	Block Type				
820284N	Case International IHC	Schlepper / JX	60			0	0	648	127	79	Block Type				
820284N	Case International IHC	Schlepper / JX	65			0	0	648	127	79	Block Type				
820284N	Case International IHC	Schlepper / JX	70			0	0	648	127	79	Block Type				
820284N	Case International IHC	Schlepper / JX	75			0	0	648	127	79	Block Type				
820284N	Case International IHC	Schlepper / JX	80			0	0	648	127	79	Block Type				
820284N	Case International IHC	Schlepper / JX	85			0	0	648	127	79	Block Type				
820284N	Case International IHC	Schlepper / JX	90			0	0	648	127	79	Block Type				
820284N	Case International IHC	Schlepper / JX	95			0	0	648	127	79	Block Type				
821888N	Case International IHC	Schlepper / JX	1060V			0	0	340	133	83					
821888N	Case International IHC	Schlepper / JX	1070N			0	0	340	133	83					
821888N	Case International IHC	Schlepper / JX	1075N			0	0	340	133	83					



Dasis Nr.	Hersteller	Modell	Typ	Bj von	Bj bis	PS	ccmTech	Netzlänge [mm]	Netzbreite [mm]	Netztiefe [mm]	Ausstattungsvariante	Einlass-Ø [mm]	Auslass-Ø [mm]	Einbaudicke [mm]	für OE-Nummer
821888N	Case International IHC	Schlepper / JX	1075V			0	0	340	133	83					
821888N	Case International IHC	Schlepper / JX	1095N			0	0	340	133	83					
821888N	Case International IHC	Schlepper / JX	1095V			0	0	340	133	83					
820286N	Case International IHC	Schlepper / JXU	70U			0	0								
820286N	Case International IHC	Schlepper / JXU	80U			0	0								
820286N	Case International IHC	Schlepper / JXU	90U			0	0								
820286N	Case International IHC	Schlepper / JXU	100U			0	0								
820286N	Case International IHC	Schlepper / JXU	1070U			0	0								
820286N	Case International IHC	Schlepper / JXU	1080U			0	0								
820286N	Case International IHC	Schlepper / JXU	1090U			0	0								
820286N	Case International IHC	Schlepper / JXU	1100U			0	0								
821887N	Case International IHC	Schlepper / MT	9080			0	0	390	127	76					134784255
821887N	Case International IHC	Schlepper / MT	9085			0	0	390	127	76					134784255
821887N	Case International IHC	Schlepper / MT	9090			0	0	390	127	76					134784255

Dasis Nr.	Hersteller	Modell	Typ	Bj von	Bj bis	PS	ccmTech	Netzlänge [mm]	Netzbreite [mm]	Netztiefe [mm]	Ausstattungsvariante	Einlass-Ø [mm]	Auslass-Ø [mm]	Einbaudicke [mm]	für OE-Nummer
821887N	Case International IHC	Schlepper / MT	9095			0	0	390	127	76					134784255
821887N	Case International IHC	Schlepper / MT	9105			0	0	390	127	76					134784255
820295N	Case International IHC	Schlepper / MX	100			0	0	514	152	70					372500A1
820295N	Case International IHC	Schlepper / MX	110			0	0	514	152	70					372500A1
820295N	Case International IHC	Schlepper / MX	120			0	0	514	152	70					372500A1
820295N	Case International IHC	Schlepper / MX	135			0	0	514	152	70					372500A1
820295N	Case International IHC	Schlepper / MX	150			0	0	514	152	70					372500A1
820295N	Case International IHC	Schlepper / MX	170			0	0	514	152	70					372500A1
820428N	Case International IHC	Schlepper / MX	180			0	0	470	265	110		12	12		29206111
820295N	Case International IHC	Schlepper / MX	180			0	0	514	152	70					372500A1
820428N	Case International IHC	Schlepper / MX	200			0	0	470	265	110		12	12		29206111
820295N	Case International IHC	Schlepper / MX	200			0	0	514	152	70					372500A1
821892N	Case International IHC	Schlepper / MX	210			0	0	413	267	110	mit Heizungskuehler				
820428N	Case International IHC	Schlepper / MX	220			0	0	470	265	110		12	12		29206111

Dasis Nr.	Hersteller	Modell	Typ	Bj von	Bj bis	PS	ccmTech	Netzlänge [mm]	Netzbreite [mm]	Netztiefe [mm]	Ausstattungsvariante	Einlass-Ø [mm]	Auslass-Ø [mm]	Einbaudicke [mm]	für OE-Nummer
820295N	Case International IHC	Schlepper / MX	220			0	0	514	152	70					372500A1
821892N	Case International IHC	Schlepper / MX	230			0	0	413	267	110	mit Heizungskuehler				
820428N	Case International IHC	Schlepper / MX	240			0	0	470	265	110		12	12		29206111
820295N	Case International IHC	Schlepper / MX	240			0	0	514	152	70					372500A1
821892N	Case International IHC	Schlepper / MX	255			0	0	413	267	110	mit Heizungskuehler				
820428N	Case International IHC	Schlepper / MX	270			0	0	470	265	110		12	12		29206111
820295N	Case International IHC	Schlepper / MX	270			0	0	514	152	70					372500A1
821892N	Case International IHC	Schlepper / MX	285			0	0	413	267	110	mit Heizungskuehler				
820059N	Case International IHC	Schlepper / MXC	80			0	0								
820059N	Case International IHC	Schlepper / MXC	90			0	0								
820059N	Case International IHC	Schlepper / MXC	100			0	0								
820285N	Case International IHC	Schlepper / MXM	120			0	0	648	127	79	Block Type				
820285N	Case International IHC	Schlepper / MXM	130			0	0	648	127	79	Block Type				
820286N	Case International IHC	Schlepper / MXM	135			0	0								

Dasis Nr.	Hersteller	Modell	Typ	Bj von	Bj bis	PS	ccmTech	Netzlänge [mm]	Netzbreite [mm]	Netztiefe [mm]	Ausstattungsvariante	Einlass-Ø [mm]	Auslass-Ø [mm]	Einbaudicke [mm]	für OE-Nummer
820285N	Case International IHC	Schlepper / MXM	140			0	0	648	127	79	Block Type				
820286N	Case International IHC	Schlepper / MXM	150			0	0								
820285N	Case International IHC	Schlepper / MXM	155			0	0	648	127	79	Block Type				
820286N	Case International IHC	Schlepper / MXM	165			0	0								
820285N	Case International IHC	Schlepper / MXM	175			0	0	648	127	79	Block Type				
820286N	Case International IHC	Schlepper / MXM	180			0	0								
820285N	Case International IHC	Schlepper / MXM	190			0	0	648	127	79	Block Type				
820094N	Case International IHC	Schlepper / MXU	100			0	0	470	127	95	Block Type	12	9,2		
820094N	Case International IHC	Schlepper / MXU	110			0	0	470	127	95	Block Type	12	9,2		
820094N	Case International IHC	Schlepper / MXU	115			0	0	470	127	95	Block Type	12	9,2		
820094N	Case International IHC	Schlepper / MXU	125			0	0	470	127	95	Block Type	12	9,2		
820094N	Case International IHC	Schlepper / MXU	130			0	0	470	127	95	Block Type	12	9,2		
820094N	Case International IHC	Schlepper / MXU	135			0	0	470	127	95	Block Type	12	9,2		
820425N	Case International IHC	Schlepper / Quadtrac	9370			0	0	445	203	95					606677T1

Dasis Nr.	Hersteller	Modell	Typ	Bj von	Bj bis	PS	ccmTech	Netzlänge [mm]	Netzbreite [mm]	Netztiefe [mm]	Ausstattungsvariante	Einlass-Ø [mm]	Auslass-Ø [mm]	Einbaudicke [mm]	für OE-Nummer
820425N	Case International IHC	Schlepper / Quadtrac	9380			0	0	445	203	95					606677T1
821893N	Case International IHC	Schlepper / Quantum	65V			0	0	330	133	83					47134607
821893N	Case International IHC	Schlepper / Quantum	75F			0	0	330	133	83					47134607
821893N	Case International IHC	Schlepper / Quantum	75N			0	0	330	133	83					47134607
821893N	Case International IHC	Schlepper / Quantum	80F			0	0	330	133	83					47134607
821893N	Case International IHC	Schlepper / Quantum	85F			0	0	330	133	83					47134607
821893N	Case International IHC	Schlepper / Quantum	85N			0	0	330	133	83					47134607
821893N	Case International IHC	Schlepper / Quantum	85V			0	0	330	133	83					47134607
821893N	Case International IHC	Schlepper / Quantum	90F			0	0	330	133	83					47134607
821893N	Case International IHC	Schlepper / Quantum	95F			0	0	330	133	83					47134607
821893N	Case International IHC	Schlepper / Quantum	95N			0	0	330	133	83					47134607
821893N	Case International IHC	Schlepper / Quantum	95V			0	0	330	133	83					47134607
821893N	Case International IHC	Schlepper / Quantum	100F			0	0	330	133	83					47134607
821893N	Case International IHC	Schlepper / Quantum	105F			0	0	330	133	83					47134607

Dasis Nr.	Hersteller	Modell	Typ	Bj von	Bj bis	PS	ccmTech	Netzlänge [mm]	Netzbreite [mm]	Netztiefe [mm]	Ausstattungsvariante	Einlass-Ø [mm]	Auslass-Ø [mm]	Einbaudicke [mm]	für OE-Nummer
821893N	Case International IHC	Schlepper / Quantum	105N			0	0	330	133	83					47134607
821893N	Case International IHC	Schlepper / Quantum	105V			0	0	330	133	83					47134607
821893N	Case International IHC	Schlepper / Quantum	110F			0	0	330	133	83					47134607
820428N	Case International IHC	SPX	4410			0	0	470	265	110		12	12		29206111
821881N	Caterpillar	Bagger 360 Grad / 300 Serie	312E			0	0	197	305	38					3639453
821881N	Caterpillar	Bagger 360 Grad / 300 Serie	312E L			0	0	197	305	38					3639453
821881N	Caterpillar	Bagger 360 Grad / 300 Serie	316E L			0	0	197	305	38					3639453
821881N	Caterpillar	Bagger 360 Grad / 300 Serie	318E L			0	0	197	305	38					3639453
821881N	Caterpillar	Bagger 360 Grad / 300 Serie	320E			0	0	197	305	38					3639453
821881N	Caterpillar	Bagger 360 Grad / 300 Serie	320E L			0	0	197	305	38					3639453
821881N	Caterpillar	Bagger 360 Grad / 300 Serie	320E LN			0	0	197	305	38					3639453
821881N	Caterpillar	Bagger 360 Grad / 300 Serie	320E LRR			0	0	197	305	38					3639453
821881N	Caterpillar	Bagger 360 Grad / 300 Serie	320E RR			0	0	197	305	38					3639453
821881N	Caterpillar	Bagger 360 Grad / 300 Serie	323E L			0	0	197	305	38					3639453
821881N	Caterpillar	Bagger 360 Grad / 300 Serie	323E LN			0	0	197	305	38					3639453
821881N	Caterpillar	Bagger 360 Grad / 300 Serie	323E SA			0	0	197	305	38					3639453
821881N	Caterpillar	Bagger 360 Grad / 300 Serie	324E L			0	0	197	305	38					3639453
821881N	Caterpillar	Bagger 360 Grad / 300 Serie	324E LN			0	0	197	305	38					3639453
821881N	Caterpillar	Bagger 360 Grad / 300 Serie	329E			0	0	197	305	38					3639453

Dasis Nr.	Hersteller	Modell	Typ	Bj von	Bj bis	PS	ccmTech	Netzlänge [mm]	Netzbreite [mm]	Netztiefe [mm]	Ausstattungsvariante	Einlass-Ø [mm]	Auslass-Ø [mm]	Einbaudicke [mm]	für OE-Nummer
821881N	Caterpillar	Bagger 360 Grad / 300 Serie	329E L			0	0	197	305	38					3639453
821881N	Caterpillar	Bagger 360 Grad / 300 Serie	329E LN			0	0	197	305	38					3639453
821881N	Caterpillar	Bagger 360 Grad / 300 Serie	336E			0	0	197	305	38					3639453
821881N	Caterpillar	Bagger 360 Grad / 300 Serie	336E H			0	0	197	305	38					3639453
821881N	Caterpillar	Bagger 360 Grad / 300 Serie	336E L			0	0	197	305	38					3639453
821881N	Caterpillar	Bagger 360 Grad / 300 Serie	336E LH			0	0	197	305	38					3639453
821881N	Caterpillar	Bagger 360 Grad / 300 Serie	336E LN			0	0	197	305	38					3639453
821881N	Caterpillar	Bagger 360 Grad / 300 Serie	336F L			0	0	197	305	38					3639453
821881N	Caterpillar	Bagger 360 Grad / 300 Serie	349E			0	0	197	305	38					3639453
821881N	Caterpillar	Bagger 360 Grad / 300 Serie	349E L			0	0	197	305	38					3639453
821881N	Caterpillar	Bagger 360 Grad / 300 Serie	349F			0	0	197	305	38					3639453
821881N	Caterpillar	Bagger 360 Grad / 300 Serie	349F L			0	0	197	305	38					3639453
821881N	Caterpillar	Bagger 360 Grad / 300 Serie	374F L			0	0	197	305	38					3639453
821881N	Caterpillar	Bagger 360 Grad / 300 Serie	390F L			0	0	197	305	38					3639453
821886N	Caterpillar	Baggerlader / 400D	420			0	0	413	232	95					
821886N	Caterpillar	Baggerlader / 400E	414E			0	0	413	232	95					
821886N	Caterpillar	Baggerlader / 400E	416E			0	0	413	232	95					
821886N	Caterpillar	Baggerlader / 400E	420E			0	0	413	232	95					
821886N	Caterpillar	Baggerlader / 400E	422E			0	0	413	232	95					
821886N	Caterpillar	Baggerlader / 400E	428E			0	0	413	232	95					
821886N	Caterpillar	Baggerlader / 400E	430E			0	0	413	232	95					

Dasis Nr.	Hersteller	Modell	Typ	Bj von	Bj bis	PS	ccmTech	Netzlänge [mm]	Netzbreite [mm]	Netztiefe [mm]	Ausstattungsvariante	Einlass-Ø [mm]	Auslass-Ø [mm]	Einbaudicke [mm]	für OE-Nummer
821886N	Caterpillar	Baggerlader / 400E	432E			0	0	413	232	95					
821886N	Caterpillar	Baggerlader / 400E	434E			0	0	413	232	95					
821886N	Caterpillar	Baggerlader / 400E	444E			0	0	413	232	95					
821886N	Caterpillar	Baggerlader / 400E	450E			0	0	413	232	95					
821886N	Caterpillar	Baggerlader / 400F	420F			0	0	413	232	95					
821886N	Caterpillar	Baggerlader / 400F	428F			0	0	413	232	95					
821886N	Caterpillar	Baggerlader / 400F	430F			0	0	413	232	95					
821886N	Caterpillar	Baggerlader / 400F	432F			0	0	413	232	95					
821886N	Caterpillar	Baggerlader / 400F	434F			0	0	413	232	95					
821886N	Caterpillar	Baggerlader / 400F	442F			0	0	413	232	95					
821886N	Caterpillar	Baggerlader / 400F	450F			0	0	413	232	95					
820427N	Caterpillar	Kniegelenke Truck / 700	725			0	0	1	1	1					3089435
820427N	Caterpillar	Kniegelenke Truck / 700	730			0	0	1	1	1					3089435
820427N	Caterpillar	Kniegelenke Truck / 700	735			0	0	1	1	1					3089435
820427N	Caterpillar	Kniegelenke Truck / 700	740			0	0	1	1	1					3089435
820427N	Caterpillar	Kniegelenke Truck / 700	770			0	0	1	1	1					3089435
820427N	Caterpillar	Kniegelenke Truck / 700	772			0	0	1	1	1					3089435
820426N	Caterpillar	Raupen Dozer / D	5M			0	0	381	203	48					1096406
820426N	Caterpillar	Raupen Dozer / D	5N			0	0	381	203	48					1096406
820426N	Caterpillar	Raupen Dozer / D	6G			0	0	381	203	48					1096406
820426N	Caterpillar	Raupen Dozer / D	6G2			0	0	381	203	48					1096406



Dasis Nr.	Hersteller	Modell	Typ	Bj von	Bj bis	PS	ccmTech	Netzlänge [mm]	Netzbreite [mm]	Netztiefe [mm]	Ausstattungsvariante	Einlass-Ø [mm]	Auslass-Ø [mm]	Einbaudicke [mm]	für OE-Nummer
820426N	Caterpillar	Raupen Dozer / D	6R			0	0	381	203	48					1096406
820426N	Caterpillar	Raupen Dozer / D	6T			0	0	381	203	48					1096406
821890N	Caterpillar	Schaufellader / 900	950G II			0	0	214	406	64					
821890N	Caterpillar	Schaufellader / 900	950H			0	0	214	406	64					
821890N	Caterpillar	Schaufellader / 900	962G II			0	0	214	406	64					
821890N	Caterpillar	Schaufellader / 900	962H			0	0	214	406	64					
821890N	Caterpillar	Schaufellader / 900	966G II			0	0	214	406	64					
821890N	Caterpillar	Schaufellader / 900	966H			0	0	214	406	64					
821890N	Caterpillar	Schaufellader / 900	972G II			0	0	214	406	64					
821890N	Caterpillar	Schaufellader / 900	972H			0	0	214	406	64					
821890N	Caterpillar	Schaufellader / 900	980G II			0	0	214	406	64					
821890N	Caterpillar	Schaufellader / 900	980H			0	0	214	406	64					
821890N	Caterpillar	Schaufellader / 900	986H			0	0	214	406	64					
820080N	Claas	Feldhäcksler / Jaguar	685			0	0	495	127	95		11,5	14,5	146	
820080N	Claas	Feldhäcksler / Jaguar	690			0	0	495	127	95		11,5	14,5	146	
820080N	Claas	Feldhäcksler / Jaguar	695			0	0	495	127	95		11,5	14,5	146	
820091N	Claas	Feldhäcksler / Jaguar	860			0	0	495	127	95	Block Type	11	14		
820091N	Claas	Feldhäcksler / Jaguar	880			0	0	495	127	95	Block Type	11	14		
820091N	Claas	Feldhäcksler / Mega	202			0	0	495	127	95	Block Type	11	14		
820091N	Claas	Feldhäcksler / Mega	203			0	0	495	127	95	Block Type	11	14		
820091N	Claas	Feldhäcksler / Mega	204			0	0	495	127	95	Block Type	11	14		

Dasis Nr.	Hersteller	Modell	Typ	Bj von	Bj bis	PS	ccmTech	Netzlänge [mm]	Netzbreite [mm]	Netztiefe [mm]	Ausstattungsvariante	Einlass-Ø [mm]	Auslass-Ø [mm]	Einbaudicke [mm]	für OE-Nummer
820091N	Claas	Feldhäcksler / Mega	208			0	0	495	127	95	Block Type	11	14		
820091N	Claas	Feldhäcksler / Mega	218			0	0	495	127	95	Block Type	11	14		
820070N	Claas	Mähdrescher / Dominator 6	56			0	0	1	1	1					
820070N	Claas	Mähdrescher / Dominator 6	66			0	0	1	1	1					
820070N	Claas	Mähdrescher / Dominator 6	76			0	0	1	1	1					
820070N	Claas	Mähdrescher / Dominator 6	86			0	0	1	1	1					
820070N	Claas	Mähdrescher / Dominator 6	96			0	0	1	1	1					
820070N	Claas	Mähdrescher / Dominator 6	106			0	0	1	1	1					
820070N	Claas	Mähdrescher / Dominator 6	116			0	0	1	1	1					
820080N	Claas	Mähdrescher / Dominator 8	98			0	0	495	127	95		11,5	14,5	146	
820080N	Claas	Mähdrescher / Dominator S	76S			0	0	495	127	95		11,5	14,5	146	
820080N	Claas	Mähdrescher / Dominator S	78S			0	0	495	127	95		11,5	14,5	146	
820080N	Claas	Mähdrescher / Dominator S	106S			0	0	495	127	95		11,5	14,5	146	
820080N	Claas	Mähdrescher / Dominator S	106SL			0	0	495	127	95		11,5	14,5	146	
820080N	Claas	Mähdrescher / Dominator S	108S			0	0	495	127	95		11,5	14,5	146	
820080N	Claas	Mähdrescher / Dominator S	108SL			0	0	495	127	95		11,5	14,5	146	
820080N	Claas	Mähdrescher / Dominator S	116			0	0	495	127	95		11,5	14,5	146	
820091N	Claas	Mähdrescher / Lexion	410			0	0	495	127	95	Block Type	11	14		
820091N	Claas	Mähdrescher / Lexion	420			0	0	495	127	95	Block Type	11	14		
820091N	Claas	Mähdrescher / Lexion	430			0	0	495	127	95	Block Type	11	14		
820091N	Claas	Mähdrescher / Lexion	450			0	0	495	127	95	Block Type	11	14		

Dasis Nr.	Hersteller	Modell	Typ	Bj von	Bj bis	PS	ccmTech	Netzlänge [mm]	Netzbreite [mm]	Netztiefe [mm]	Ausstattungsvariante	Einlass-Ø [mm]	Auslass-Ø [mm]	Einbaudicke [mm]	für OE-Nummer
820091N	Claas	Mähdrescher / Lexion	460			0	0	495	127	95	Block Type	11	14		
820091N	Claas	Mähdrescher / Lexion	480			0	0	495	127	95	Block Type	11	14		
820393N	Claas	Mähdrescher / Lexion	620			0	0	483	127	95					0005589150
820393N	Claas	Mähdrescher / Lexion	630			0	0	483	127	95					0005589150
820393N	Claas	Mähdrescher / Lexion	650			0	0	483	127	95					0005589150
820393N	Claas	Mähdrescher / Lexion	660			0	0	483	127	95					0005589150
820393N	Claas	Mähdrescher / Lexion	670			0	0	483	127	95					0005589150
820393N	Claas	Mähdrescher / Lexion	740			0	0	483	127	95					0005589150
820393N	Claas	Mähdrescher / Lexion	750			0	0	483	127	95					0005589150
820393N	Claas	Mähdrescher / Lexion	760			0	0	483	127	95					0005589150
820393N	Claas	Mähdrescher / Lexion	770			0	0	483	127	95					0005589150
820393N	Claas	Mähdrescher / Lexion	780			0	0	483	127	95					0005589150
820080N	Claas	Mähdrescher / Mega	202			0	0	495	127	95		11,5	14,5	146	
820080N	Claas	Mähdrescher / Mega	203			0	0	495	127	95		11,5	14,5	146	
820080N	Claas	Mähdrescher / Mega	204			0	0	495	127	95		11,5	14,5	146	
820080N	Claas	Mähdrescher / Mega	208			0	0	495	127	95		11,5	14,5	146	
820080N	Claas	Mähdrescher / Mega	218			0	0	495	127	95		11,5	14,5	146	
820393N	Claas	Mähdrescher / Tucano	320			0	0	483	127	95					0005589150
820393N	Claas	Mähdrescher / Tucano	420			0	0	483	127	95					0005589150
820393N	Claas	Mähdrescher / Tucano	430			0	0	483	127	95					0005589150
820393N	Claas	Mähdrescher / Tucano	450			0	0	483	127	95					0005589150

Dasis Nr.	Hersteller	Modell	Typ	Bj von	Bj bis	PS	ccmTech	Netzlänge [mm]	Netzbreite [mm]	Netztiefe [mm]	Ausstattungsvariante	Einlass-Ø [mm]	Auslass-Ø [mm]	Einbaudicke [mm]	für OE-Nummer
820997N	Claas	Teleskoplader / Scorpion	6030			0	0	395	150	60		14	11		
820997N	Claas	Teleskoplader / Scorpion	6040			0	0	395	150	60		14	11		
820997N	Claas	Teleskoplader / Scorpion	7030			0	0	395	150	60		14	11		
820997N	Claas	Teleskoplader / Scorpion	7040			0	0	395	150	60		14	11		
820997N	Claas	Teleskoplader / Scorpion	7045			0	0	395	150	60		14	11		
820997N	Claas	Teleskoplader / Scorpion	9040			0	0	395	150	60		14	11		
820428N	Daewoo / Doosan / Moxy	Bagger / Solar	130LC-V			0	0	470	265	110		12	12		29206111
820428N	Daewoo / Doosan / Moxy	Bagger / Solar	130W-V			0	0	470	265	110		12	12		29206111
820428N	Daewoo / Doosan / Moxy	Bagger / Solar	140LC-V			0	0	470	265	110		12	12		29206111
820428N	Daewoo / Doosan / Moxy	Bagger / Solar	140W-V			0	0	470	265	110		12	12		29206111
820428N	Daewoo / Doosan / Moxy	Bagger / Solar	150LC-V			0	0	470	265	110		12	12		29206111
820428N	Daewoo / Doosan / Moxy	Bagger / Solar	155LC-V			0	0	470	265	110		12	12		29206111
820428N	Daewoo / Doosan / Moxy	Bagger / Solar	160W-V			0	0	470	265	110		12	12		29206111
820428N	Daewoo / Doosan / Moxy	Bagger / Solar	170LC-V			0	0	470	265	110		12	12		29206111
820428N	Daewoo / Doosan / Moxy	Bagger / Solar	170W-V			0	0	470	265	110		12	12		29206111
820428N	Daewoo / Doosan / Moxy	Bagger / Solar	175LC-V			0	0	470	265	110		12	12		29206111
820428N	Daewoo / Doosan / Moxy	Bagger / Solar	180W-V			0	0	470	265	110		12	12		29206111
820428N	Daewoo / Doosan / Moxy	Bagger / Solar	200W-V			0	0	470	265	110		12	12		29206111
820428N	Daewoo / Doosan / Moxy	Bagger / Solar	210W-V			0	0	470	265	110		12	12		29206111
820428N	Daewoo / Doosan / Moxy	Bagger / Solar	220LC-V			0	0	470	265	110		12	12		29206111
820428N	Daewoo / Doosan / Moxy	Bagger / Solar	220LL			0	0	470	265	110		12	12		29206111

Dasis Nr.	Hersteller	Modell	Typ	Bj von	Bj bis	PS	ccmTech	Netzlänge [mm]	Netzbreite [mm]	Netztiefe [mm]	Ausstattungsvariante	Einlass-Ø [mm]	Auslass-Ø [mm]	Einbaudicke [mm]	für OE-Nummer
820428N	Daewoo / Doosan / Moxy	Bagger / Solar	220N-V			0	0	470	265	110		12	12		29206111
820428N	Daewoo / Doosan / Moxy	Bagger / Solar	225LC-V			0	0	470	265	110		12	12		29206111
820428N	Daewoo / Doosan / Moxy	Bagger / Solar	225LL			0	0	470	265	110		12	12		29206111
820428N	Daewoo / Doosan / Moxy	Bagger / Solar	225NLC-V			0	0	470	265	110		12	12		29206111
820428N	Daewoo / Doosan / Moxy	Bagger / Solar	230LC-V			0	0	470	265	110		12	12		29206111
820428N	Daewoo / Doosan / Moxy	Bagger / Solar	250LC-V			0	0	470	265	110		12	12		29206111
820428N	Daewoo / Doosan / Moxy	Bagger / Solar	255LC-V			0	0	470	265	110		12	12		29206111
820428N	Daewoo / Doosan / Moxy	Bagger / Solar	290LC-V			0	0	470	265	110		12	12		29206111
820428N	Daewoo / Doosan / Moxy	Bagger / Solar	290LL			0	0	470	265	110		12	12		29206111
820428N	Daewoo / Doosan / Moxy	Bagger / Solar	300LC-V			0	0	470	265	110		12	12		29206111
820428N	Daewoo / Doosan / Moxy	Bagger / Solar	300LL			0	0	470	265	110		12	12		29206111
820428N	Daewoo / Doosan / Moxy	Bagger / Solar	330LC-V			0	0	470	265	110		12	12		29206111
820428N	Daewoo / Doosan / Moxy	Bagger / Solar	340LC-V			0	0	470	265	110		12	12		29206111
820428N	Daewoo / Doosan / Moxy	Bagger / Solar	400LC-V			0	0	470	265	110		12	12		29206111
820428N	Daewoo / Doosan / Moxy	Bagger / Solar	420LC-V			0	0	470	265	110		12	12		29206111
820428N	Daewoo / Doosan / Moxy	Bagger / Solar	450LC-V			0	0	470	265	110		12	12		29206111
820428N	Daewoo / Doosan / Moxy	Bagger / Solar	470LV-V			0	0	470	265	110		12	12		29206111
820428N	Daewoo / Doosan / Moxy	Bagger / Solar	500LC-V			0	0	470	265	110		12	12		29206111
820428N	Daewoo / Doosan / Moxy	BAGGERLADER / MEGA	160			0	0	470	265	110		12	12		29206111
820428N	Daewoo / Doosan / Moxy	BAGGERLADER / MEGA	160TC			0	0	470	265	110		12	12		29206111
820428N	Daewoo / Doosan / Moxy	BAGGERLADER / MEGA	200-V			0	0	470	265	110		12	12		29206111

Dasis Nr.	Hersteller	Modell	Typ	Bj von	Bj bis	PS	ccmTech	Netzlänge [mm]	Netzbreite [mm]	Netztiefe [mm]	Ausstattungsvariante	Einlass-Ø [mm]	Auslass-Ø [mm]	Einbaudicke [mm]	für OE-Nummer
820428N	Daewoo / Doosan / Moxy	BAGGERLADER / MEGA	200TC-V			0	0	470	265	110		12	12		29206111
820428N	Daewoo / Doosan / Moxy	BAGGERLADER / MEGA	250-V			0	0	470	265	110		12	12		29206111
820428N	Daewoo / Doosan / Moxy	BAGGERLADER / MEGA	300-V			0	0	470	265	110		12	12		29206111
820428N	Daewoo / Doosan / Moxy	BAGGERLADER / MEGA	400-V			0	0	470	265	110		12	12		29206111
820428N	Daewoo / Doosan / Moxy	BAGGERLADER / MEGA	500-V			0	0	470	265	110		12	12		29206111
820428N	Daewoo / Doosan / Moxy	BAGGERLADER / MEGA	500-VTIER-II			0	0	470	265	110		12	12		29206111
821891N	Deutz	Mähdrescher / Actor	5510			0	0	330	178	80					
821891N	Deutz	Mähdrescher / Actor	5520			0	0	330	178	80					
821891N	Deutz	Mähdrescher / Ectron	5530			0	0	330	178	80					
821891N	Deutz	Mähdrescher / Farmliner	3370			0	0	330	178	80					
821891N	Deutz	Schlepper / AgroStar	4.61			0	0	330	178	80					
821891N	Deutz	Schlepper / AgroStar	4.68			0	0	330	178	80					
821891N	Deutz	Schlepper / AgroStar	4.71			0	0	330	178	80					
821891N	Deutz	Schlepper / AgroStar	4.78			0	0	330	178	80					
821891N	Deutz	Schlepper / AgroStar	6.08			0	0	330	178	80					
821891N	Deutz	Schlepper / AgroStar	6.11			0	0	330	178	80					
821891N	Deutz	Schlepper / AgroStar	6.21			0	0	330	178	80					
821891N	Deutz	Schlepper / AgroStar	6.28			0	0	330	178	80					
821891N	Deutz	Schlepper / AgroStar	6.31			0	0	330	178	80					
821891N	Deutz	Schlepper / AgroStar	6.38			0	0	330	178	80					
821891N	Deutz	Schlepper / AgroStar	6.61			0	0	330	178	80					

Dasis Nr.	Hersteller	Modell	Typ	Bj von	Bj bis	PS	ccmTech	Netzlänge [mm]	Netzbreite [mm]	Netztiefe [mm]	Ausstattungsvariante	Einlass-Ø [mm]	Auslass-Ø [mm]	Einbaudicke [mm]	für OE-Nummer
821891N	Deutz	Schlepper / AgroStar	6.71			0	0	330	178	80					
821891N	Deutz	Schlepper / AgroStar	6.81			0	0	330	178	80					
820289N	Deutz	Schlepper / Agrottron mk1	4.70			0	0	305	190	82					001020450
820289N	Deutz	Schlepper / Agrottron mk1	4.80			0	0	305	190	82					001020450
820289N	Deutz	Schlepper / Agrottron mk1	4.85			0	0	305	190	82					001020450
820289N	Deutz	Schlepper / Agrottron mk1	4.90			0	0	305	190	82					001020450
820289N	Deutz	Schlepper / Agrottron mk1	4.95			0	0	305	190	82					001020450
820289N	Deutz	Schlepper / Agrottron mk1	6.00			0	0	305	190	82					001020450
820289N	Deutz	Schlepper / Agrottron mk1	6.01			0	0	305	190	82					001020450
820289N	Deutz	Schlepper / Agrottron mk1	6.05			0	0	305	190	82					001020450
820289N	Deutz	Schlepper / Agrottron mk1	6.15			0	0	305	190	82					001020450
820289N	Deutz	Schlepper / Agrottron mk1	6.20			0	0	305	190	82					001020450
820289N	Deutz	Schlepper / Agrottron mk1	6.30			0	0	305	190	82					001020450
820289N	Deutz	Schlepper / Agrottron mk1	6.45			0	0	305	190	82					001020450
820289N	Deutz	Schlepper / Agrottron mk2	80			0	0	305	190	82					001020450
820289N	Deutz	Schlepper / Agrottron mk2	85			0	0	305	190	82					001020450
820289N	Deutz	Schlepper / Agrottron mk2	90			0	0	305	190	82					001020450
820289N	Deutz	Schlepper / Agrottron mk2	100			0	0	305	190	82					001020450
820289N	Deutz	Schlepper / Agrottron mk2	105			0	0	305	190	82					001020450
820289N	Deutz	Schlepper / Agrottron mk2	106			0	0	305	190	82					001020450
820289N	Deutz	Schlepper / Agrottron mk2	110			0	0	305	190	82					001020450

Dasis Nr.	Hersteller	Modell	Typ	Bj von	Bj bis	PS	ccmTech	Netzlänge [mm]	Netzbreite [mm]	Netztiefe [mm]	Ausstattungsvariante	Einlass-Ø [mm]	Auslass-Ø [mm]	Einbaudicke [mm]	für OE-Nummer
820289N	Deutz	Schlepper / Agrottron mk2	115			0	0	305	190	82					001020450
820289N	Deutz	Schlepper / Agrottron mk2	120			0	0	305	190	82					001020450
820289N	Deutz	Schlepper / Agrottron mk2	135			0	0	305	190	82					001020450
820289N	Deutz	Schlepper / Agrottron mk2	150			0	0	305	190	82					001020450
820289N	Deutz	Schlepper / Agrottron mk2	160			0	0	305	190	82					001020450
820289N	Deutz	Schlepper / Agrottron mk2	175			0	0	305	190	82					001020450
820289N	Deutz	Schlepper / Agrottron mk2	200			0	0	305	190	82					001020450
820289N	Deutz	Schlepper / Agrottron mk2	230			0	0	305	190	82					001020450
820289N	Deutz	Schlepper / Agrottron mk2	260			0	0	305	190	82					001020450
820289N	Deutz	Schlepper / Agrottron mk3	80			0	0	305	190	82					001020450
820289N	Deutz	Schlepper / Agrottron mk3	85			0	0	305	190	82					001020450
820289N	Deutz	Schlepper / Agrottron mk3	90			0	0	305	190	82					001020450
820289N	Deutz	Schlepper / Agrottron mk3	100			0	0	305	190	82					001020450
820395N	Deutz	Schlepper / Agrottron mk3	100			0	0	355	175	75		11,9	11,9		
820395N	Deutz	Schlepper / Agrottron mk3	100P			0	0	355	175	75		11,9	11,9		
820289N	Deutz	Schlepper / Agrottron mk3	105			0	0	305	190	82					001020450
820395N	Deutz	Schlepper / Agrottron mk3	105			0	0	355	175	75		11,9	11,9		
820289N	Deutz	Schlepper / Agrottron mk3	106			0	0	305	190	82					001020450
820395N	Deutz	Schlepper / Agrottron mk3	106			0	0	355	175	75		11,9	11,9		
820289N	Deutz	Schlepper / Agrottron mk3	110			0	0	305	190	82					001020450
820395N	Deutz	Schlepper / Agrottron mk3	110			0	0	355	175	75		11,9	11,9		



Dasis Nr.	Hersteller	Modell	Typ	Bj von	Bj bis	PS	ccmTech	Netzlänge [mm]	Netzbreite [mm]	Netztiefe [mm]	Ausstattungsvariante	Einlass-Ø [mm]	Auslass-Ø [mm]	Einbaudicke [mm]	für OE-Nummer
820395N	Deutz	Schlepper / Agrottron mk3	110P			0	0	355	175	75		11,9	11,9		
820289N	Deutz	Schlepper / Agrottron mk3	115			0	0	305	190	82					001020450
820395N	Deutz	Schlepper / Agrottron mk3	115			0	0	355	175	75		11,9	11,9		
820289N	Deutz	Schlepper / Agrottron mk3	120			0	0	305	190	82					001020450
820395N	Deutz	Schlepper / Agrottron mk3	120			0	0	355	175	75		11,9	11,9		
820395N	Deutz	Schlepper / Agrottron mk3	120P			0	0	355	175	75		11,9	11,9		
820289N	Deutz	Schlepper / Agrottron mk3	135			0	0	305	190	82					001020450
820395N	Deutz	Schlepper / Agrottron mk3	135			0	0	355	175	75		11,9	11,9		
820289N	Deutz	Schlepper / Agrottron mk3	150			0	0	305	190	82					001020450
820395N	Deutz	Schlepper / Agrottron mk3	150			0	0	355	175	75		11,9	11,9		
820289N	Deutz	Schlepper / Agrottron mk3	160			0	0	305	190	82					001020450
820395N	Deutz	Schlepper / Agrottron mk3	160			0	0	355	175	75		11,9	11,9		
820395N	Deutz	Schlepper / Agrottron mk3	165			0	0	355	175	75		11,9	11,9		
820289N	Deutz	Schlepper / Agrottron mk3	175			0	0	305	190	82					001020450
820395N	Deutz	Schlepper / Agrottron mk3	175			0	0	355	175	75		11,9	11,9		
820289N	Deutz	Schlepper / Agrottron mk3	200			0	0	305	190	82					001020450
820395N	Deutz	Schlepper / Agrottron mk3	200			0	0	355	175	75		11,9	11,9		
820289N	Deutz	Schlepper / Agrottron mk3	230			0	0	305	190	82					001020450
820395N	Deutz	Schlepper / Agrottron mk3	230			0	0	355	175	75		11,9	11,9		
820289N	Deutz	Schlepper / Agrottron mk3	260			0	0	305	190	82					001020450
820395N	Deutz	Schlepper / Agrottron mk3	260			0	0	355	175	75		11,9	11,9		
821891N	Deutz	Schlepper / DX	230			0	0	330	178	80					

Dasis Nr.	Hersteller	Modell	Typ	Bj von	Bj bis	PS	ccmTech	Netzlänge [mm]	Netzbreite [mm]	Netztiefe [mm]	Ausstattungsvariante	Einlass-Ø [mm]	Auslass-Ø [mm]	Einbaudicke [mm]	für OE-Nummer
821891N	Deutz	Schlepper / DX	250			0	0	330	178	80					
820302N	Deutz	Schlepper / DX4	4.10			0	0								
820302N	Deutz	Schlepper / DX4	4.30			0	0								
820302N	Deutz	Schlepper / DX4	4.50			0	0								
820302N	Deutz	Schlepper / DX4	4.70			0	0								
820302N	Deutz	Schlepper / DX6	6.05			0	0								
820302N	Deutz	Schlepper / DX6	6.10			0	0								
820302N	Deutz	Schlepper / DX6	6.30			0	0								
820302N	Deutz	Schlepper / DX6	6.50			0	0								
821884N	Fendt	Schlepper / Farmer 200	250S			0	0	1	1	1					F205550050440
821884N	Fendt	Schlepper / Farmer 200	250V			0	0	1	1	1					F205550050440
821884N	Fendt	Schlepper / Farmer 200	260S			0	0	1	1	1					F205550050440
821884N	Fendt	Schlepper / Farmer 200	260V			0	0	1	1	1					F205550050440
821884N	Fendt	Schlepper / Farmer 200	270P			0	0	1	1	1					F205550050440
821884N	Fendt	Schlepper / Farmer 200	270V			0	0	1	1	1					F205550050440
821884N	Fendt	Schlepper / Farmer 200	275S			0	0	1	1	1					F205550050440
821884N	Fendt	Schlepper / Farmer 200	275V			0	0	1	1	1					F205550050440
821884N	Fendt	Schlepper / Farmer 200	280P			0	0	1	1	1					F205550050440
821884N	Fendt	Schlepper / Farmer 200	280S			0	0	1	1	1					F205550050440
821884N	Fendt	Schlepper / Farmer 200	280V			0	0	1	1	1					F205550050440
820429N	Fendt	Schlepper / Vario	207			0	0	1	1	1					F334550010190
820429N	Fendt	Schlepper / Vario	208			0	0	1	1	1					F334550010190
820429N	Fendt	Schlepper / Vario	209			0	0	1	1	1					F334550010190
820429N	Fendt	Schlepper / Vario	210			0	0	1	1	1					F334550010190
820429N	Fendt	Schlepper / Vario	211			0	0	1	1	1					F334550010190
820205N	Fendt	Schlepper / Vario	309			0	0	1	1	1					F339552050020

Dasis Nr.	Hersteller	Modell	Typ	Bj von	Bj bis	PS	ccmTech	Netzlänge [mm]	Netzbreite [mm]	Netztiefe [mm]	Ausstattungsvariante	Einlass-Ø [mm]	Auslass-Ø [mm]	Einbaudicke [mm]	für OE-Nummer
820205N	Fendt	Schlepper / Vario	310			0	0	1	1	1					F339552050020
820205N	Fendt	Schlepper / Vario	312			0	0	1	1	1					F339552050020
820205N	Fendt	Schlepper / Vario	313			0	0	1	1	1					F339552050020
820205N	Fendt	Schlepper / Vario	411			0	0	1	1	1					F339552050020
820205N	Fendt	Schlepper / Vario	412			0	0	1	1	1					F339552050020
820205N	Fendt	Schlepper / Vario	413			0	0	1	1	1					F339552050020
820205N	Fendt	Schlepper / Vario	414			0	0	1	1	1					F339552050020
820205N	Fendt	Schlepper / Vario	415			0	0	1	1	1					F339552050020
821889N	Fendt	Schlepper / Vario	512			0	0	420	210	85		14	12		
821889N	Fendt	Schlepper / Vario	513			0	0	420	210	85		14	12		
821889N	Fendt	Schlepper / Vario	514			0	0	420	210	85		14	12		
821889N	Fendt	Schlepper / Vario	516			0	0	420	210	85		14	12		
820205N	Fendt	Schlepper / Vario	712			0	0	1	1	1					F339552050020
820205N	Fendt	Schlepper / Vario	714			0	0	1	1	1					F339552050020
820205N	Fendt	Schlepper / Vario	716			0	0	1	1	1					F339552050020
820205N	Fendt	Schlepper / Vario	718			0	0	1	1	1					F339552050020
821889N	Fendt	Schlepper / Vario	720			0	0	420	210	85		14	12		
821889N	Fendt	Schlepper / Vario	722			0	0	420	210	85		14	12		
821889N	Fendt	Schlepper / Vario	724			0	0	420	210	85		14	12		
820205N	Fendt	Schlepper / Vario	818			0	0	1	1	1					F339552050020
820205N	Fendt	Schlepper / Vario	820			0	0	1	1	1					F339552050020
820429N	Fendt	Schlepper / Vario / TMS	207			0	0	1	1	1					F334550010190
820429N	Fendt	Schlepper / Vario / TMS	208			0	0	1	1	1					F334550010190
820429N	Fendt	Schlepper / Vario / TMS	209			0	0	1	1	1					F334550010190
820429N	Fendt	Schlepper / Vario / TMS	210			0	0	1	1	1					F334550010190
820429N	Fendt	Schlepper / Vario / TMS	211			0	0	1	1	1					F334550010190
825005N	Fendt	Schlepper / Vario / TMS	922			0	0	385	210	75		14	14		
825005N	Fendt	Schlepper / Vario / TMS	924			0	0	385	210	75		14	14		

Dasis Nr.	Hersteller	Modell	Typ	Bj von	Bj bis	PS	ccmTech	Netzlänge [mm]	Netzbreite [mm]	Netztiefe [mm]	Ausstattungsvariante	Einlass-Ø [mm]	Auslass-Ø [mm]	Einbaudicke [mm]	für OE-Nummer
825005N	Fendt	Schlepper / Vario / TMS	927			0	0	385	210	75		14	14		
825005N	Fendt	Schlepper / Vario / TMS	930			0	0	385	210	75		14	14		
825005N	Fendt	Schlepper / Vario / TMS	933			0	0	385	210	75		14	14		
825005N	Fendt	Schlepper / Vario / TMS	936			0	0	385	210	75		14	14		
820285N	Fiat / Hitachi	Schlepper / M	100			0	0	648	127	79	Block Type				
820285N	Fiat / Hitachi	Schlepper / M	115			0	0	648	127	79	Block Type				
820285N	Fiat / Hitachi	Schlepper / M	135			0	0	648	127	79	Block Type				
820285N	Fiat / Hitachi	Schlepper / M	160			0	0	648	127	79	Block Type				
820285N	Fiat / Hitachi	Schlepper / M	180			0	0	648	127	79	Block Type				
820415N	JCB	Bagger 360° / 8000	8080			0	0	356	178	76					30925915
820415N	JCB	Bagger 360° / 8000	8085			0	0	356	178	76					30925915
820996N	JCB	Bagger 360° / JS	130VV			0	0	435	178	64					30/926001
820996N	JCB	Bagger 360° / JS	130VV-P			0	0	435	178	64					30/926001
820996N	JCB	Bagger 360° / JS	145			0	0	435	178	64					30/926001
820996N	JCB	Bagger 360° / JS	145VV			0	0	435	178	64					30/926001
820996N	JCB	Bagger 360° / JS	150VV			0	0	435	178	64					30/926001
820996N	JCB	Bagger 360° / JS	160			0	0	435	178	64					30/926001
820996N	JCB	Bagger 360° / JS	160VV			0	0	435	178	64					30/926001
820996N	JCB	Bagger 360° / JS	160VV-P			0	0	435	178	64					30/926001
820996N	JCB	Bagger 360° / JS	175VV			0	0	435	178	64					30/926001
820996N	JCB	Bagger 360° / JS	180			0	0	435	178	64					30/926001
820996N	JCB	Bagger 360° / JS	200			0	0	435	178	64					30/926001
820996N	JCB	Bagger 360° / JS	200W			0	0	435	178	64					30/926001
820996N	JCB	Bagger 360° / JS	200W-P			0	0	435	178	64					30/926001
820996N	JCB	Bagger 360° / JS	210			0	0	435	178	64					30/926001
820996N	JCB	Bagger 360° / JS	220			0	0	435	178	64					30/926001
820996N	JCB	Bagger 360° / JS	240			0	0	435	178	64					30/926001
820996N	JCB	Bagger 360° / JS	260			0	0	435	178	64					30/926001
820996N	JCB	Bagger 360° / JS	330			0	0	435	178	64					30/926001

Dasis Nr.	Hersteller	Modell	Typ	Bj von	Bj bis	PS	ccmTech	Netzlänge [mm]	Netzbreite [mm]	Netztiefe [mm]	Ausstattungsvariante	Einlass-Ø [mm]	Auslass-Ø [mm]	Einbaudicke [mm]	für OE-Nummer
820996N	JCB	Bagger 360 ° / JS	330XD			0	0	435	178	64					30/926001
820293N	JCB	Baggerlader	RTFL			0	0								
821885N	JCB	Baggerlader / 400	426			0	0	378	254	83					30926446 332F9269
821885N	JCB	Baggerlader / 400	434			0	0	378	254	83					30926446 332F9269
821885N	JCB	Baggerlader / 400	436			0	0	378	254	83					30926446 332F9269
821885N	JCB	Baggerlader / 400	446			0	0	378	254	83					30926446 332F9269
821885N	JCB	Baggerlader / 400	456			0	0	378	254	83					30926446 332F9269
821885N	JCB	Kipper	726			0	0	378	254	83					30926446 332F9269
820998N	JCB	Schlepper / Fastrac 3000	3155			0	0	1	1	1					30925431
820998N	JCB	Schlepper / Fastrac 3000	3170			0	0	1	1	1					30925431
820998N	JCB	Schlepper / Fastrac 3000	3185			0	0	1	1	1					30925431
820998N	JCB	Schlepper / Fastrac 3000	3190			0	0	1	1	1					30925431
820998N	JCB	Schlepper / Fastrac 3000	3200			0	0	1	1	1					30925431
820998N	JCB	Schlepper / Fastrac 3000	3220			0	0	1	1	1					30925431
820998N	JCB	Schlepper / Fastrac 3000	3230			0	0	1	1	1					30925431
820998N	JCB	Schlepper / Fastrac 3000	3250			0	0	1	1	1					30925431
820995N	JCB	Schlepper / Fastrac 7000	7170			0	0	449	203	111		8	10		332F2306
820995N	JCB	Schlepper / Fastrac 7000	7200			0	0	449	203	111		8	10		332F2306
820995N	JCB	Schlepper / Fastrac 7000	7230			0	0	449	203	111		8	10		332F2306
820995N	JCB	Schlepper / Fastrac 7000	7270			0	0	449	203	111		8	10		332F2306
820995N	JCB	Schlepper / Fastrac 8000	8250			0	0	449	203	111		8	10		332F2306
820288N	JCB	Teleskoplader / 500 Serie	520M			0	0								

Dasis Nr.	Hersteller	Modell	Typ	Bj von	Bj bis	PS	ccmTech	Netzlänge [mm]	Netzbreite [mm]	Netztiefe [mm]	Ausstattungsvariante	Einlass-Ø [mm]	Auslass-Ø [mm]	Einbaudicke [mm]	für OE-Nummer
820288N	JCB	Teleskoplader / 500 Serie	520S			0	0								
820288N	JCB	Teleskoplader / 500 Serie	525			0	0								
820288N	JCB	Teleskoplader / 500 Serie	525B			0	0								
820084N	JCB	Teleskoplader / 500 Serie	526S			0	0	298	127	83					30918001
820998N	JCB	Teleskoplader / Fastrac 3000	3155			0	0	1	1	1					30925431
820998N	JCB	Teleskoplader / Fastrac 3000	3185			0	0	1	1	1					30925431
820998N	JCB	Teleskoplader / Fastrac 3000	3190			0	0	1	1	1					30925431
820998N	JCB	Teleskoplader / Fastrac 3000	3220			0	0	1	1	1					30925431
820101N	JCB	Teleskoplader / SXL	530			0	0								
820101N	JCB	Teleskoplader / SXL	540			0	0								
821883N	John Deere	Baggerlader / 110-726B	310G			0	0	343	254	79		8	6		AT392552 RE162768 RE177968
821883N	John Deere	Baggerlader / 110-726B	310J			0	0	343	254	79		8	6		AT392552 RE162768 RE177968
821883N	John Deere	Baggerlader / 110-726B	310SG			0	0	343	254	79		8	6		AT392552 RE162768 RE177968
821883N	John Deere	Baggerlader / 110-726B	310SJ			0	0	343	254	79		8	6		AT392552 RE162768 RE177968
821883N	John Deere	Baggerlader / 110-726B	315SG			0	0	343	254	79		8	6		AT392552 RE162768 RE177968
821883N	John Deere	Baggerlader / 110-726B	410G			0	0	343	254	79		8	6		AT392552 RE162768 RE177968
821883N	John Deere	Baggerlader / 110-726B	410J			0	0	343	254	79		8	6		AT392552 RE162768 RE177968

Dasis Nr.	Hersteller	Modell	Typ	Bj von	Bj bis	PS	ccmTech	Netzlänge [mm]	Netzbreite [mm]	Netztiefe [mm]	Ausstattungsvariante	Einlass-Ø [mm]	Auslass-Ø [mm]	Einbaudicke [mm]	für OE-Nummer
821883N	John Deere	Baggerlader / 110-726B	644K			0	0	343	254	79		8	6		AT392552 RE162768 RE177968
821883N	John Deere	Baggerlader / 110-726B	710G			0	0	343	254	79		8	6		AT392552 RE162768 RE177968
821883N	John Deere	Baggerlader / 110-726B	724K			0	0	343	254	79		8	6		AT392552 RE162768 RE177968
820061N	John Deere	Mähdrescher / 900-1188	1052			0	0	737	127	79					
820061N	John Deere	Mähdrescher / 900-1188	1055			0	0	737	127	79					
820061N	John Deere	Mähdrescher / 900-1188	1065			0	0	737	127	79					
820061N	John Deere	Mähdrescher / 900-1188	1068H			0	0	737	127	79					
820061N	John Deere	Mähdrescher / 900-1188	1072			0	0	737	127	79					
820061N	John Deere	Mähdrescher / 900-1188	1075			0	0	737	127	79					
820061N	John Deere	Mähdrescher / 900-1188	1075H4			0	0	737	127	79					
820061N	John Deere	Mähdrescher / 900-1188	1085			0	0	737	127	79					
820061N	John Deere	Mähdrescher / 900-1188	1085H4			0	0	737	127	79					
820287N	John Deere	Schlepper / 300-955	830			0	0	737	127	79		14	22		
820287N	John Deere	Schlepper / 300-955	840			0	0	737	127	79		14	22		
820287N	John Deere	Schlepper / 300-955	930			0	0	737	127	79		14	22		
820287N	John Deere	Schlepper / 300-955	940			0	0	737	127	79		14	22		
820287N	John Deere	Schlepper / 1000-1950	1030			0	0	737	127	79		14	22		
820287N	John Deere	Schlepper / 1000-1950	1040			0	0	737	127	79		14	22		
820287N	John Deere	Schlepper / 1000-1950	1130			0	0	737	127	79		14	22		
820287N	John Deere	Schlepper / 1000-1950	1140			0	0	737	127	79		14	22		

Dasis Nr.	Hersteller	Modell	Typ	Bj von	Bj bis	PS	ccmTech	Netzlänge [mm]	Netzbreite [mm]	Netztiefe [mm]	Ausstattungsvariante	Einlass-Ø [mm]	Auslass-Ø [mm]	Einbaudicke [mm]	für OE-Nummer
820287N	John Deere	Schlepper / 1000-1950	1350			0	0	737	127	79		14	22		
820287N	John Deere	Schlepper / 1000-1950	1530			0	0	737	127	79		14	22		
820287N	John Deere	Schlepper / 1000-1950	1550			0	0	737	127	79		14	22		
820287N	John Deere	Schlepper / 1000-1950	1630			0	0	737	127	79		14	22		
820287N	John Deere	Schlepper / 1000-1950	1640			0	0	737	127	79		14	22		
820287N	John Deere	Schlepper / 1000-1950	1750			0	0	737	127	79		14	22		
820287N	John Deere	Schlepper / 1000-1950	1830			0	0	737	127	79		14	22		
820287N	John Deere	Schlepper / 1000-1950	1840			0	0	737	127	79		14	22		
820287N	John Deere	Schlepper / 1000-1950	1850			0	0	737	127	79		14	22		
820287N	John Deere	Schlepper / 1000-1950	1950			0	0	737	127	79		14	22		
820287N	John Deere	Schlepper / 2000-2955	2030			0	0	737	127	79		14	22		
820287N	John Deere	Schlepper / 2000-2955	2040			0	0	737	127	79		14	22		
820287N	John Deere	Schlepper / 2000-2955	2040S			0	0	737	127	79		14	22		
820287N	John Deere	Schlepper / 2000-2955	2130			0	0	737	127	79		14	22		
820287N	John Deere	Schlepper / 2000-2955	2140			0	0	737	127	79		14	22		
820287N	John Deere	Schlepper / 2000-2955	2250			0	0	737	127	79		14	22		
820287N	John Deere	Schlepper / 2000-2955	2450			0	0	737	127	79		14	22		
820287N	John Deere	Schlepper / 2000-2955	2550			0	0	737	127	79		14	22		
820287N	John Deere	Schlepper / 2000-2955	2650			0	0	737	127	79		14	22		
820287N	John Deere	Schlepper / 2000-2955	2850			0	0	737	127	79		14	22		
820287N	John Deere	Schlepper / 3000-3650	3030			0	0	737	127	79		14	22		



Dasis Nr.	Hersteller	Modell	Typ	Bj von	Bj bis	PS	ccmTech	Netzlänge [mm]	Netzbreite [mm]	Netztiefe [mm]	Ausstattungsvariante	Einlass-Ø [mm]	Auslass-Ø [mm]	Einbaudicke [mm]	für OE-Nummer
820287N	John Deere	Schlepper / 3000-3650	3040			0	0	737	127	79		14	22		
820287N	John Deere	Schlepper / 3000-3650	3050			0	0	737	127	79		14	22		
820287N	John Deere	Schlepper / 3000-3650	3130			0	0	737	127	79		14	22		
820287N	John Deere	Schlepper / 3000-3650	3140			0	0	737	127	79		14	22		
820287N	John Deere	Schlepper / 3000-3650	3150			0	0	737	127	79		14	22		
820287N	John Deere	Schlepper / 3000-3650	3340			0	0	737	127	79		14	22		
820287N	John Deere	Schlepper / 3000-3650	3350			0	0	737	127	79		14	22		
820287N	John Deere	Schlepper / 3000-3650	3640			0	0	737	127	79		14	22		
820287N	John Deere	Schlepper / 3000-3650	3650			0	0	737	127	79		14	22		
820287N	John Deere	Schlepper / 4000-4955	4040			0	0	737	127	79		14	22		
820287N	John Deere	Schlepper / 4000-4955	4040S			0	0	737	127	79		14	22		
820287N	John Deere	Schlepper / 4000-4955	4050			0	0	737	127	79		14	22		
820287N	John Deere	Schlepper / 4000-4955	4230			0	0	737	127	79		14	22		
820287N	John Deere	Schlepper / 4000-4955	4240			0	0	737	127	79		14	22		
820287N	John Deere	Schlepper / 4000-4955	4240S			0	0	737	127	79		14	22		
820287N	John Deere	Schlepper / 4000-4955	4250			0	0	737	127	79		14	22		
820287N	John Deere	Schlepper / 4000-4955	4350			0	0	737	127	79		14	22		
820287N	John Deere	Schlepper / 4000-4955	4430			0	0	737	127	79		14	22		
820287N	John Deere	Schlepper / 4000-4955	4440			0	0	737	127	79		14	22		
820287N	John Deere	Schlepper / 4000-4955	4450			0	0	737	127	79		14	22		
820287N	John Deere	Schlepper / 4000-4955	4630			0	0	737	127	79		14	22		

Dasis Nr.	Hersteller	Modell	Typ	Bj von	Bj bis	PS	ccmTech	Netzlänge [mm]	Netzbreite [mm]	Netztiefe [mm]	Ausstattungsvariante	Einlass-Ø [mm]	Auslass-Ø [mm]	Einbaudicke [mm]	für OE-Nummer
820287N	John Deere	Schlepper / 4000-4955	4640			0	0	737	127	79		14	22		
820287N	John Deere	Schlepper / 4000-4955	4650			0	0	737	127	79		14	22		
820287N	John Deere	Schlepper / 4000-4955	4840			0	0	737	127	79		14	22		
820287N	John Deere	Schlepper / 4000-4955	4850			0	0	737	127	79		14	22		
820019N	John Deere	Schlepper / 5000-5820	5210			0	0	737	152	64		13	11		AL160350 AL163863
820019N	John Deere	Schlepper / 5000-5820	5220			0	0	737	152	64		13	11		AL160350 AL163863
820019N	John Deere	Schlepper / 5000-5820	5225			0	0	737	152	64		13	11		AL160350 AL163863
820019N	John Deere	Schlepper / 5000-5820	5310			0	0	737	152	64		13	11		AL160350 AL163863
820019N	John Deere	Schlepper / 5000-5820	5325			0	0	737	152	64		13	11		AL160350 AL163863
820019N	John Deere	Schlepper / 5000-5820	5410			0	0	737	152	64		13	11		AL160350 AL163863
820019N	John Deere	Schlepper / 5000-5820	5425			0	0	737	152	64		13	11		AL160350 AL163863
820019N	John Deere	Schlepper / 5000-5820	5510			0	0	737	152	64		13	11		AL160350 AL163863
820019N	John Deere	Schlepper / 5000-5820	5520			0	0	737	152	64		13	11		AL160350 AL163863
820019N	John Deere	Schlepper / 5000-5820	5525			0	0	737	152	64		13	11		AL160350 AL163863
820019N	John Deere	Schlepper / 5000-5820	5625			0	0	737	152	64		13	11		AL160350 AL163863
820017N	John Deere	Schlepper / 6000-6930	6120			0	0	730	152	98		14	11		AL112100 AL119098 AL160349 AL163862
820019N	John Deere	Schlepper / 6000-6930	6120			0	0	737	152	64		13	11		AL160350 AL163863
820017N	John Deere	Schlepper / 6000-6930	6120M			0	0	730	152	98		14	11		AL112100 AL119098 AL160349 AL163862

Dasis Nr.	Hersteller	Modell	Typ	Bj von	Bj bis	PS	ccmTech	Netzlänge [mm]	Netzbreite [mm]	Netztiefe [mm]	Ausstattungsvariante	Einlass-Ø [mm]	Auslass-Ø [mm]	Einbaudicke [mm]	für OE-Nummer
820017N	John Deere	Schlepper / 6000-6930	6120R			0	0	730	152	98		14	11		AL112100 AL119098 AL160349 AL163862
820017N	John Deere	Schlepper / 6000-6930	6120SE			0	0	730	152	98		14	11		AL112100 AL119098 AL160349 AL163862
820017N	John Deere	Schlepper / 6000-6930	6200			0	0	730	152	98		14	11		AL112100 AL119098 AL160349 AL163862
820017N	John Deere	Schlepper / 6000-6930	6200SE			0	0	730	152	98		14	11		AL112100 AL119098 AL160349 AL163862
820017N	John Deere	Schlepper / 6000-6930	6220			0	0	730	152	98		14	11		AL112100 AL119098 AL160349 AL163862
820019N	John Deere	Schlepper / 6000-6930	6220			0	0	737	152	64		13	11		AL160350 AL163863
820017N	John Deere	Schlepper / 6000-6930	6220SE			0	0	730	152	98		14	11		AL112100 AL119098 AL160349 AL163862
820019N	John Deere	Schlepper / 6000-6930	6230			0	0	737	152	64		13	11		AL160350 AL163863
820017N	John Deere	Schlepper / 6000-6930	6300			0	0	730	152	98		14	11		AL112100 AL119098 AL160349 AL163862
820017N	John Deere	Schlepper / 6000-6930	6300SE			0	0	730	152	98		14	11		AL112100 AL119098 AL160349 AL163862
820017N	John Deere	Schlepper / 6000-6930	6320			0	0	730	152	98		14	11		AL112100 AL119098 AL160349 AL163862
820019N	John Deere	Schlepper / 6000-6930	6320			0	0	737	152	64		13	11		AL160350 AL163863

Dasis Nr.	Hersteller	Modell	Typ	Bj von	Bj bis	PS	ccmTech	Netzlänge [mm]	Netzbreite [mm]	Netztiefe [mm]	Ausstattungsvariante	Einlass-Ø [mm]	Auslass-Ø [mm]	Einbaudicke [mm]	für OE-Nummer
820017N	John Deere	Schlepper / 6000-6930	6320SE			0	0	730	152	98		14	11		AL112100 AL119098 AL160349 AL163862
820019N	John Deere	Schlepper / 6000-6930	6330			0	0	737	152	64		13	11		AL160350 AL163863
820019N	John Deere	Schlepper / 6000-6930	6420			0	0	737	152	64		13	11		AL160350 AL163863
820019N	John Deere	Schlepper / 6000-6930	6430			0	0	737	152	64		13	11		AL160350 AL163863
820019N	John Deere	Schlepper / 6000-6930	6620			0	0	737	152	64		13	11		AL160350 AL163863
820019N	John Deere	Schlepper / 6000-6930	6630			0	0	737	152	64		13	11		AL160350 AL163863
820019N	John Deere	Schlepper / 6000-6930	6820			0	0	737	152	64		13	11		AL160350 AL163863
820019N	John Deere	Schlepper / 6000-6930	6830			0	0	737	152	64		13	11		AL160350 AL163863
820019N	John Deere	Schlepper / 6000-6930	6930			0	0	737	152	64		13	11		AL160350 AL163863
820019N	John Deere	Schlepper / 7000-7920	7130			0	0	737	152	64		13	11		AL160350 AL163863
820388N	John Deere	Schlepper / 7000-7920	7185			0	0	343	254	95					RE187311
820071N	John Deere	Schlepper / 7000-7920	7200			0	0	737	156	95		10	12		RE152404 RE180243 RE241384
820071N	John Deere	Schlepper / 7000-7920	7200R			0	0	737	156	95		10	12		RE152404 RE180243 RE241384
820388N	John Deere	Schlepper / 7000-7920	7205			0	0	343	254	95					RE187311
820071N	John Deere	Schlepper / 7000-7920	7205			0	0	737	156	95		10	12		RE152404 RE180243 RE241384
820071N	John Deere	Schlepper / 7000-7920	7210			0	0	737	156	95		10	12		RE152404 RE180243 RE241384
820071N	John Deere	Schlepper / 7000-7920	7210R			0	0	737	156	95		10	12		RE152404 RE180243 RE241384

Dasis Nr.	Hersteller	Modell	Typ	Bj von	Bj bis	PS	ccmTech	Netzlänge [mm]	Netzbreite [mm]	Netztiefe [mm]	Ausstattungsvariante	Einlass-Ø [mm]	Auslass-Ø [mm]	Einbaudicke [mm]	für OE-Nummer
820071N	John Deere	Schlepper / 7000-7920	7215R			0	0	737	156	95		10	12		RE152404 RE180243 RE241384
820019N	John Deere	Schlepper / 7000-7920	7220			0	0	737	152	64		13	11		AL160350 AL163863
820071N	John Deere	Schlepper / 7000-7920	7220			0	0	737	156	95		10	12		RE152404 RE180243 RE241384
820388N	John Deere	Schlepper / 7000-7920	7225			0	0	343	254	95					RE187311
820071N	John Deere	Schlepper / 7000-7920	7225			0	0	737	156	95		10	12		RE152404 RE180243 RE241384
820019N	John Deere	Schlepper / 7000-7920	7230			0	0	737	152	64		13	11		AL160350 AL163863
820071N	John Deere	Schlepper / 7000-7920	7230R			0	0	737	156	95		10	12		RE152404 RE180243 RE241384
820071N	John Deere	Schlepper / 7000-7920	7260R			0	0	737	156	95		10	12		RE152404 RE180243 RE241384
820071N	John Deere	Schlepper / 7000-7920	7280R			0	0	737	156	95		10	12		RE152404 RE180243 RE241384
820019N	John Deere	Schlepper / 7000-7920	7320			0	0	737	152	64		13	11		AL160350 AL163863
820071N	John Deere	Schlepper / 7000-7920	7320			0	0	737	156	95		10	12		RE152404 RE180243 RE241384
820019N	John Deere	Schlepper / 7000-7920	7330			0	0	737	152	64		13	11		AL160350 AL163863
820071N	John Deere	Schlepper / 7000-7920	7330			0	0	737	156	95		10	12		RE152404 RE180243 RE241384
820071N	John Deere	Schlepper / 7000-7920	7400			0	0	737	156	95		10	12		RE152404 RE180243 RE241384
820071N	John Deere	Schlepper / 7000-7920	7410			0	0	737	156	95		10	12		RE152404 RE180243 RE241384
820019N	John Deere	Schlepper / 7000-7920	7420			0	0	737	152	64		13	11		AL160350 AL163863

Dasis Nr.	Hersteller	Modell	Typ	Bj von	Bj bis	PS	ccmTech	Netzlänge [mm]	Netzbreite [mm]	Netztiefe [mm]	Ausstattungsvariante	Einlass-Ø [mm]	Auslass-Ø [mm]	Einbaudicke [mm]	für OE-Nummer
820071N	John Deere	Schlepper / 7000-7920	7420			0	0	737	156	95		10	12		RE152404 RE180243 RE241384
820019N	John Deere	Schlepper / 7000-7920	7430			0	0	737	152	64		13	11		AL160350 AL163863
820071N	John Deere	Schlepper / 7000-7920	7430			0	0	737	156	95		10	12		RE152404 RE180243 RE241384
820019N	John Deere	Schlepper / 7000-7920	7430PR			0	0	737	152	64		13	11		AL160350 AL163863
820071N	John Deere	Schlepper / 7000-7920	7430PR			0	0	737	156	95		10	12		RE152404 RE180243 RE241384
820071N	John Deere	Schlepper / 7000-7920	7510			0	0	737	156	95		10	12		RE152404 RE180243 RE241384
820071N	John Deere	Schlepper / 7000-7920	7520			0	0	737	156	95		10	12		RE152404 RE180243 RE241384
820071N	John Deere	Schlepper / 7000-7920	7530			0	0	737	156	95		10	12		RE152404 RE180243 RE241384
820071N	John Deere	Schlepper / 7000-7920	7600			0	0	737	156	95		10	12		RE152404 RE180243 RE241384
820071N	John Deere	Schlepper / 7000-7920	7610			0	0	737	156	95		10	12		RE152404 RE180243 RE241384
820071N	John Deere	Schlepper / 7000-7920	7700			0	0	737	156	95		10	12		RE152404 RE180243 RE241384
820071N	John Deere	Schlepper / 7000-7920	7710			0	0	737	156	95		10	12		RE152404 RE180243 RE241384
821883N	John Deere	Schlepper / 7000-7920	7715			0	0	343	254	79		8	6		AT392552 RE162768 RE177968
820071N	John Deere	Schlepper / 7000-7920	7715			0	0	737	156	95		10	12		RE152404 RE180243 RE241384
820388N	John Deere	Schlepper / 7000-7920	7720			0	0	343	254	95					RE187311

Dasis Nr.	Hersteller	Modell	Typ	Bj von	Bj bis	PS	ccmTech	Netzlänge [mm]	Netzbreite [mm]	Netztiefe [mm]	Ausstattungsvariante	Einlass-Ø [mm]	Auslass-Ø [mm]	Einbaudicke [mm]	für OE-Nummer
820071N	John Deere	Schlepper / 7000-7920	7720			0	0	737	156	95		10	12		RE152404 RE180243 RE241384
820071N	John Deere	Schlepper / 7000-7920	7800			0	0	737	156	95		10	12		RE152404 RE180243 RE241384
820071N	John Deere	Schlepper / 7000-7920	7810			0	0	737	156	95		10	12		RE152404 RE180243 RE241384
821883N	John Deere	Schlepper / 7000-7920	7815			0	0	343	254	79		8	6		AT392552 RE162768 RE177968
821883N	John Deere	Schlepper / 8000-8640	8110			0	0	343	254	79		8	6		AT392552 RE162768 RE177968
820388N	John Deere	Schlepper / 8000-8640	8110			0	0	343	254	95					RE187311
821883N	John Deere	Schlepper / 8000-8640	8110T			0	0	343	254	79		8	6		AT392552 RE162768 RE177968
820388N	John Deere	Schlepper / 8000-8640	8120			0	0	343	254	95					RE187311
821883N	John Deere	Schlepper / 8000-8640	8130			0	0	343	254	79		8	6		AT392552 RE162768 RE177968
821883N	John Deere	Schlepper / 8000-8640	8130T			0	0	343	254	79		8	6		AT392552 RE162768 RE177968
821883N	John Deere	Schlepper / 8000-8640	8210			0	0	343	254	79		8	6		AT392552 RE162768 RE177968
820388N	John Deere	Schlepper / 8000-8640	8210			0	0	343	254	95					RE187311
821883N	John Deere	Schlepper / 8000-8640	8210T			0	0	343	254	79		8	6		AT392552 RE162768 RE177968
820388N	John Deere	Schlepper / 8000-8640	8220			0	0	343	254	95					RE187311
821883N	John Deere	Schlepper / 8000-8640	8230			0	0	343	254	79		8	6		AT392552 RE162768 RE177968

Dasis Nr.	Hersteller	Modell	Typ	Bj von	Bj bis	PS	ccmTech	Netzlänge [mm]	Netzbreite [mm]	Netztiefe [mm]	Ausstattungsvariante	Einlass-Ø [mm]	Auslass-Ø [mm]	Einbaudicke [mm]	für OE-Nummer
821883N	John Deere	Schlepper / 8000-8640	8310			0	0	343	254	79		8	6		AT392552 RE162768 RE177968
821883N	John Deere	Schlepper / 8000-8640	8310T			0	0	343	254	79		8	6		AT392552 RE162768 RE177968
821883N	John Deere	Schlepper / 8000-8640	8410			0	0	343	254	79		8	6		AT392552 RE162768 RE177968
821883N	John Deere	Schlepper / 8000-8640	8410T			0	0	343	254	79		8	6		AT392552 RE162768 RE177968
820287N	John Deere	Schlepper / 8000-8640	8430			0	0	737	127	79		14	22		
821883N	John Deere	Schlepper / 8000-8640	8430 MFWD			0	0	343	254	79		8	6		AT392552 RE162768 RE177968
820287N	John Deere	Schlepper / 8000-8640	8440			0	0	737	127	79		14	22		
821883N	John Deere	Schlepper / 8000-8640	8530T			0	0	343	254	79		8	6		AT392552 RE162768 RE177968
820287N	John Deere	Schlepper / 8000-8640	8640			0	0	737	127	79		14	22		
821883N	John Deere	Schlepper / 9000-9620	9100			0	0	343	254	79		8	6		AT392552 RE162768 RE177968
820388N	John Deere	Schlepper / 9000-9620	9100			0	0	343	254	95					RE187311
821883N	John Deere	Schlepper / 9000-9620	9200			0	0	343	254	79		8	6		AT392552 RE162768 RE177968
820388N	John Deere	Schlepper / 9000-9620	9200			0	0	343	254	95					RE187311
821883N	John Deere	Schlepper / 9000-9620	9300			0	0	343	254	79		8	6		AT392552 RE162768 RE177968
820388N	John Deere	Schlepper / 9000-9620	9300			0	0	343	254	95					RE187311
821883N	John Deere	Schlepper / 9000-9620	9300T			0	0	343	254	79		8	6		AT392552 RE162768 RE177968



Dasis Nr.	Hersteller	Modell	Typ	Bj von	Bj bis	PS	ccmTech	Netzlänge [mm]	Netzbreite [mm]	Netztiefe [mm]	Ausstattungsvariante	Einlass-Ø [mm]	Auslass-Ø [mm]	Einbaudicke [mm]	für OE-Nummer
821883N	John Deere	Schlepper / 9000-9620	9400			0	0	343	254	79		8	6		AT392552 RE162768 RE177968
820388N	John Deere	Schlepper / 9000-9620	9400			0	0	343	254	95					RE187311
821883N	John Deere	Schlepper / 9000-9620	9400T			0	0	343	254	79		8	6		AT392552 RE162768 RE177968
821883N	John Deere	Selbstfahrende Feldspritze	4700			0	0	343	254	79		8	6		AT392552 RE162768 RE177968
821883N	John Deere	Selbstfahrende Feldspritze	4710			0	0	343	254	79		8	6		AT392552 RE162768 RE177968
820416N	Kobelco	Blade Runner	ED150			0	0	1	1	1					YN20M001075020
820416N	Kobelco	Blade Runner	ED160			0	0	1	1	1					YN20M001075020
820416N	Kobelco	Blade Runner	ED195-8			0	0	1	1	1					YN20M001075020
820416N	Kobelco	Kettenbagger	80CS			0	0	1	1	1					YN20M001075020
820416N	Kobelco	Kettenbagger	140SR			0	0	1	1	1					YN20M001075020
820416N	Kobelco	Kettenbagger / Sk	80CS-2			0	0	1	1	1					YN20M001075020
820416N	Kobelco	Kettenbagger / Sk	140SRLC			0	0	1	1	1					YN20M001075020
820416N	Kobelco	Kettenbagger / Sk	210LC-8			0	0	1	1	1					YN20M001075020
820416N	Kobelco	Kettenbagger / Sk	215SRLC			0	0	1	1	1					YN20M001075020
820416N	Kobelco	Kettenbagger / Sk	235SRLC-2			0	0	1	1	1					YN20M001075020
820416N	Kobelco	Kettenbagger / Sk	295-8			0	0	1	1	1					YN20M001075020
820416N	Kobelco	Kettenbagger / Sk	350-8			0	0	1	1	1					YN20M001075020
820416N	Kobelco	Kettenbagger / Sk	850			0	0	1	1	1					YN20M001075020
820389N	Komatsu	Muldenkipper / HD	325-6			0	0	222	248	89					
820389N	Komatsu	Muldenkipper / HD	405-6			0	0	222	248	89					
820389N	Komatsu	Muldenkipper / HD	465-5			0	0	222	248	89					

Dasis Nr.	Hersteller	Modell	Typ	Bj von	Bj bis	PS	ccmTech	Netzlänge [mm]	Netzbreite [mm]	Netztiefe [mm]	Ausstattungsvariante	Einlass-Ø [mm]	Auslass-Ø [mm]	Einbaudicke [mm]	für OE-Nummer
820389N	Komatsu	Schaufellader / WA	200-5 Lader			0	0	222	248	89					
820389N	Komatsu	Schaufellader / WA	250 Lader			0	0	222	248	89					
820389N	Komatsu	Schaufellader / WA	320 Lader			0	0	222	248	89					
820386N	Kubota	Tractor M Serie	M105			0	0	546	105	83					3F76096190
820386N	Kubota	Tractor M Serie	M108			0	0	546	105	83					3F76096190
820386N	Kubota	Tractor M Serie	M110			0	0	546	105	83					3F76096190
820386N	Kubota	Tractor M Serie	M120			0	0	546	105	83					3F76096190
820386N	Kubota	Tractor M Serie	M125			0	0	546	105	83					3F76096190
820386N	Kubota	Tractor M Serie	M126			0	0	546	105	83					3F76096190
820386N	Kubota	Tractor M Serie	M135			0	0	546	105	83					3F76096190
820391N	Landini	Schlepper	65			0	0	292	171	76					3680158M91
820391N	Landini	Schlepper	75			0	0	292	171	76					3680158M91
820391N	Landini	Schlepper	85			0	0	292	171	76					3680158M91
820391N	Landini	Schlepper	7800			0	0	292	171	76					3680158M91
820071N	Landini	Schlepper / Mythos	115			0	0	737	156	95		10	12		RE152404 RE180243 RE241384
820092N	Massey Ferguson	Mähdrescher / 3400-9790	7250			0	0	622	114	83	Block Type	14	14		
820092N	Massey Ferguson	Mähdrescher / 3400-9790	7252			0	0	622	114	83	Block Type	14	14		
820092N	Massey Ferguson	Mähdrescher / 3400-9790	7254			0	0	622	114	83	Block Type	14	14		
820092N	Massey Ferguson	Mähdrescher / 3400-9790	7256			0	0	622	114	83	Block Type	14	14		
820092N	Massey Ferguson	Mähdrescher / 3400-9790	7272			0	0	622	114	83	Block Type	14	14		
820092N	Massey Ferguson	Mähdrescher / 3400-9790	7274			0	0	622	114	83	Block Type	14	14		
820092N	Massey Ferguson	Mähdrescher / 3400-9790	7276			0	0	622	114	83	Block Type	14	14		
820387N	Massey Ferguson	MF 5400	5425			0	0	619	102	76					3909742M91
820387N	Massey Ferguson	MF 5400	5435			0	0	619	102	76					3909742M91

Dasis Nr.	Hersteller	Modell	Typ	Bj von	Bj bis	PS	ccmTech	Netzlänge [mm]	Netzbreite [mm]	Netztiefe [mm]	Ausstattungsvariante	Einlass-Ø [mm]	Auslass-Ø [mm]	Einbaudicke [mm]	für OE-Nummer
820387N	Massey Ferguson	MF 5400	5445			0	0	619	102	76					3909742M91
820387N	Massey Ferguson	MF 5400	5455			0	0	619	102	76					3909742M91
820387N	Massey Ferguson	MF 5600	5608			85	0	619	102	76					3909742M91
820387N	Massey Ferguson	MF 5600	5609			95	0	619	102	76					3909742M91
820387N	Massey Ferguson	MF 5600	5610			105	0	619	102	76					3909742M91
820387N	Massey Ferguson	MF 5600	5611			110	0	619	102	76					3909742M91
820387N	Massey Ferguson	MF 5600	5612			120	0	619	102	76					3909742M91
820387N	Massey Ferguson	MF 5600	5613			130	0	619	102	76					3909742M91
820387N	Massey Ferguson	MF 6600	6612			120	0	619	102	76					3909742M91
820387N	Massey Ferguson	MF 6600	6613			130	0	619	102	76					3909742M91
820387N	Massey Ferguson	MF 6600	6614			140	0	619	102	76					3909742M91
820387N	Massey Ferguson	MF 6600	6615			150	0	619	102	76					3909742M91
820387N	Massey Ferguson	MF 6600	6616			160	0	619	102	76					3909742M91
820387N	Massey Ferguson	MF 7600	7614			140	0	619	102	76					3909742M91
820387N	Massey Ferguson	MF 7600	7615			150	0	619	102	76					3909742M91
820387N	Massey Ferguson	MF 7600	7616			160	0	619	102	76					3909742M91
820387N	Massey Ferguson	MF 7600	7618			175	0	619	102	76					3909742M91
820387N	Massey Ferguson	MF 7600	7619			185	0	619	102	76					3909742M91
820387N	Massey Ferguson	MF 7600	7620			200	0	619	102	76					3909742M91
820387N	Massey Ferguson	MF 7600	7622			215	0	619	102	76					3909742M91
820387N	Massey Ferguson	MF 7600	7624			235	0	619	102	76					3909742M91

Dasis Nr.	Hersteller	Modell	Typ	Bj von	Bj bis	PS	ccmTech	Netzlänge [mm]	Netzbreite [mm]	Netztiefe [mm]	Ausstattungsvariante	Einlass-Ø [mm]	Auslass-Ø [mm]	Einbaudicke [mm]	für OE-Nummer
820387N	Massey Ferguson	MF 7600	7626			255	0	619	102	76					3909742M91
820390N	Massey Ferguson	MF 8600	8650			0	0	711	102	76					4284950M1
820390N	Massey Ferguson	MF 8600	8660			0	0	711	102	76					4284950M1
820390N	Massey Ferguson	MF 8600	8670			0	0	711	102	76					4284950M1
820390N	Massey Ferguson	MF 8600	8680			0	0	711	102	76					4284950M1
820390N	Massey Ferguson	MF 8600	8690			0	0	711	102	76					4284950M1
820392N	Massey Ferguson	MF 8700	8727			240	0	1	1	1					4292687M91
820392N	Massey Ferguson	MF 8700	8730			265	0	1	1	1					4292687M91
820392N	Massey Ferguson	MF 8700	8732			290	0	1	1	1					4292687M91
820392N	Massey Ferguson	MF 8700	8735			320	0	1	1	1					4292687M91
820392N	Massey Ferguson	MF 8700	8737			340	0	1	1	1					4292687M91
820079N	Massey Ferguson	Schlepper / 300	340			0	0	343	127	44					
820079N	Massey Ferguson	Schlepper / 300	342			0	0	343	127	44					
820079N	Massey Ferguson	Schlepper / 300	350			0	0	343	127	44					
820079N	Massey Ferguson	Schlepper / 300	352			0	0	343	127	44					
820079N	Massey Ferguson	Schlepper / 300	353			0	0	343	127	44					
820079N	Massey Ferguson	Schlepper / 300	354			0	0	343	127	44					
820079N	Massey Ferguson	Schlepper / 300	355			0	0	343	127	44					
820079N	Massey Ferguson	Schlepper / 300	360			0	0	343	127	44					
820079N	Massey Ferguson	Schlepper / 300	362			0	0	343	127	44					
820079N	Massey Ferguson	Schlepper / 300	362N			0	0	343	127	44					

Dasis Nr.	Hersteller	Modell	Typ	Bj von	Bj bis	PS	ccmTech	Netzlänge [mm]	Netzbreite [mm]	Netztiefe [mm]	Ausstattungsvariante	Einlass-Ø [mm]	Auslass-Ø [mm]	Einbaudicke [mm]	für OE-Nummer
820079N	Massey Ferguson	Schlepper / 300	363			0	0	343	127	44					
820079N	Massey Ferguson	Schlepper / 300	365			0	0	343	127	44					
820079N	Massey Ferguson	Schlepper / 300	372			0	0	343	127	44					
820079N	Massey Ferguson	Schlepper / 300	375			0	0	343	127	44					
820079N	Massey Ferguson	Schlepper / 300	377			0	0	343	127	44					
820079N	Massey Ferguson	Schlepper / 300	382			0	0	343	127	44					
820079N	Massey Ferguson	Schlepper / 300	384S			0	0	343	127	44					
820079N	Massey Ferguson	Schlepper / 300	387			0	0	343	127	44					
820079N	Massey Ferguson	Schlepper / 300	390			0	0	343	127	44					
820079N	Massey Ferguson	Schlepper / 300	390T			0	0	343	127	44					
820079N	Massey Ferguson	Schlepper / 300	397			0	0	343	127	44					
820079N	Massey Ferguson	Schlepper / 300	398			0	0	343	127	44					
820079N	Massey Ferguson	Schlepper / 300	399			0	0	343	127	44					
820391N	Massey Ferguson	Schlepper / 2000	2430			0	0	292	171	76					3680158M91
820391N	Massey Ferguson	Schlepper / 2000	2435			0	0	292	171	76					3680158M91
820391N	Massey Ferguson	Schlepper / 2000	2440			0	0	292	171	76					3680158M91
820150N	Massey Ferguson	Schlepper / 3000	3050			0	0	622	102	76	Block Type				
820092N	Massey Ferguson	Schlepper / 3000	3050			0	0	622	114	83	Block Type	14	14		
820150N	Massey Ferguson	Schlepper / 3000	3060			0	0	622	102	76	Block Type				
820092N	Massey Ferguson	Schlepper / 3000	3060			0	0	622	114	83	Block Type	14	14		
820150N	Massey Ferguson	Schlepper / 3000	3065			0	0	622	102	76	Block Type				

Dasis Nr.	Hersteller	Modell	Typ	Bj von	Bj bis	PS	ccmTech	Netzlänge [mm]	Netzbreite [mm]	Netztiefe [mm]	Ausstattungsvariante	Einlass-Ø [mm]	Auslass-Ø [mm]	Einbaudicke [mm]	für OE-Nummer
820092N	Massey Ferguson	Schlepper / 3000	3065			0	0	622	114	83	Block Type	14	14		
820150N	Massey Ferguson	Schlepper / 3000	3070			0	0	622	102	76	Block Type				
820092N	Massey Ferguson	Schlepper / 3000	3070			0	0	622	114	83	Block Type	14	14		
820150N	Massey Ferguson	Schlepper / 3000	3075			0	0	622	102	76	Block Type				
820092N	Massey Ferguson	Schlepper / 3000	3075			0	0	622	114	83	Block Type	14	14		
820150N	Massey Ferguson	Schlepper / 3000	3080			0	0	622	102	76	Block Type				
820092N	Massey Ferguson	Schlepper / 3000	3080			0	0	622	114	83	Block Type	14	14		
820150N	Massey Ferguson	Schlepper / 3000	3085			0	0	622	102	76	Block Type				
820092N	Massey Ferguson	Schlepper / 3000	3085			0	0	622	114	83	Block Type	14	14		
820150N	Massey Ferguson	Schlepper / 3000	3090			0	0	622	102	76	Block Type				
820092N	Massey Ferguson	Schlepper / 3000	3090			0	0	622	114	83	Block Type	14	14		
820150N	Massey Ferguson	Schlepper / 3000	3095			0	0	622	102	76	Block Type				
820092N	Massey Ferguson	Schlepper / 3000	3095			0	0	622	114	83	Block Type	14	14		
820150N	Massey Ferguson	Schlepper / 3000	3115			0	0	622	102	76	Block Type				
820092N	Massey Ferguson	Schlepper / 3000	3115			0	0	622	114	83	Block Type	14	14		
820150N	Massey Ferguson	Schlepper / 3000	3120			0	0	622	102	76	Block Type				
820092N	Massey Ferguson	Schlepper / 3000	3120			0	0	622	114	83	Block Type	14	14		
820150N	Massey Ferguson	Schlepper / 3000	3120T			0	0	622	102	76	Block Type				
820092N	Massey Ferguson	Schlepper / 3000	3120T			0	0	622	114	83	Block Type	14	14		
820150N	Massey Ferguson	Schlepper / 3000	3125			0	0	622	102	76	Block Type				
820092N	Massey Ferguson	Schlepper / 3000	3125			0	0	622	114	83	Block Type	14	14		

Dasis Nr.	Hersteller	Modell	Typ	Bj von	Bj bis	PS	ccmTech	Netzlänge [mm]	Netzbreite [mm]	Netztiefe [mm]	Ausstattungsvariante	Einlass-Ø [mm]	Auslass-Ø [mm]	Einbaudicke [mm]	für OE-Nummer
820150N	Massey Ferguson	Schlepper / 3000	3140			0	0	622	102	76	Block Type				
820092N	Massey Ferguson	Schlepper / 3000	3140			0	0	622	114	83	Block Type	14	14		
820394N	Massey Ferguson	Schlepper / 3000	3610			0	0	570	170	60					ACP0246850
820150N	Massey Ferguson	Schlepper / 3000	3610			0	0	622	102	76	Block Type				
820092N	Massey Ferguson	Schlepper / 3000	3610			0	0	622	114	83	Block Type	14	14		
820394N	Massey Ferguson	Schlepper / 3000	3615			0	0	570	170	60					ACP0246850
820394N	Massey Ferguson	Schlepper / 3000	3625			0	0	570	170	60					ACP0246850
820394N	Massey Ferguson	Schlepper / 3000	3630			0	0	570	170	60					ACP0246850
820150N	Massey Ferguson	Schlepper / 3000	3630			0	0	622	102	76	Block Type				
820092N	Massey Ferguson	Schlepper / 3000	3630			0	0	622	114	83	Block Type	14	14		
820394N	Massey Ferguson	Schlepper / 3000	3635			0	0	570	170	60					ACP0246850
820150N	Massey Ferguson	Schlepper / 3000	3635			0	0	622	102	76	Block Type				
820092N	Massey Ferguson	Schlepper / 3000	3635			0	0	622	114	83	Block Type	14	14		
820394N	Massey Ferguson	Schlepper / 3000	3640			0	0	570	170	60					ACP0246850
820394N	Massey Ferguson	Schlepper / 3000	3645			0	0	570	170	60					ACP0246850
820150N	Massey Ferguson	Schlepper / 3000	3645			0	0	622	102	76	Block Type				
820092N	Massey Ferguson	Schlepper / 3000	3645			0	0	622	114	83	Block Type	14	14		
820394N	Massey Ferguson	Schlepper / 3000	3650			0	0	570	170	60					ACP0246850
820150N	Massey Ferguson	Schlepper / 3000	3650			0	0	622	102	76	Block Type				
820092N	Massey Ferguson	Schlepper / 3000	3650			0	0	622	114	83	Block Type	14	14		
820394N	Massey Ferguson	Schlepper / 3000	3655			0	0	570	170	60					ACP0246850

Dasis Nr.	Hersteller	Modell	Typ	Bj von	Bj bis	PS	ccmTech	Netzlänge [mm]	Netzbreite [mm]	Netztiefe [mm]	Ausstattungsvariante	Einlass-Ø [mm]	Auslass-Ø [mm]	Einbaudicke [mm]	für OE-Nummer
820150N	Massey Ferguson	Schlepper / 3000	3655			0	0	622	102	76	Block Type				
820092N	Massey Ferguson	Schlepper / 3000	3655			0	0	622	114	83	Block Type	14	14		
820394N	Massey Ferguson	Schlepper / 3000	3660			0	0	570	170	60					ACP0246850
820150N	Massey Ferguson	Schlepper / 3000	3660			0	0	622	102	76	Block Type				
820092N	Massey Ferguson	Schlepper / 3000	3660			0	0	622	114	83	Block Type	14	14		
820394N	Massey Ferguson	Schlepper / 3000	3670			0	0	570	170	60					ACP0246850
820150N	Massey Ferguson	Schlepper / 3000	3670			0	0	622	102	76	Block Type				
820092N	Massey Ferguson	Schlepper / 3000	3670			0	0	622	114	83	Block Type	14	14		
820394N	Massey Ferguson	Schlepper / 3000	3680			0	0	570	170	60					ACP0246850
820150N	Massey Ferguson	Schlepper / 3000	3680			0	0	622	102	76	Block Type				
820092N	Massey Ferguson	Schlepper / 3000	3680			0	0	622	114	83	Block Type	14	14		
820394N	Massey Ferguson	Schlepper / 3000	3690			0	0	570	170	60					ACP0246850
820150N	Massey Ferguson	Schlepper / 3000	3690			0	0	622	102	76	Block Type				
820092N	Massey Ferguson	Schlepper / 3000	3690			0	0	622	114	83	Block Type	14	14		
820067N	Massey Ferguson	Schlepper / 4000	4215			0	0	673	114	111	Block Type				
820067N	Massey Ferguson	Schlepper / 4000	4220			0	0	673	114	111	Block Type				
820067N	Massey Ferguson	Schlepper / 4000	4225			0	0	673	114	111	Block Type				
820067N	Massey Ferguson	Schlepper / 4000	4235			0	0	673	114	111	Block Type				
820067N	Massey Ferguson	Schlepper / 4000	4240			0	0	673	114	111	Block Type				
820067N	Massey Ferguson	Schlepper / 4000	4243			0	0	673	114	111	Block Type				
820067N	Massey Ferguson	Schlepper / 4000	4245			0	0	673	114	111	Block Type				



Dasis Nr.	Hersteller	Modell	Typ	Bj von	Bj bis	PS	ccmTech	Netzlänge [mm]	Netzbreite [mm]	Netztiefe [mm]	Ausstattungsvariante	Einlass-Ø [mm]	Auslass-Ø [mm]	Einbaudicke [mm]	für OE-Nummer
820067N	Massey Ferguson	Schlepper / 4000	4253			0	0	673	114	111	Block Type				
820067N	Massey Ferguson	Schlepper / 4000	4255			0	0	673	114	111	Block Type				
820067N	Massey Ferguson	Schlepper / 4000	4260			0	0	673	114	111	Block Type				
820067N	Massey Ferguson	Schlepper / 4000	4263			0	0	673	114	111	Block Type				
820067N	Massey Ferguson	Schlepper / 4000	4265			0	0	673	114	111	Block Type				
820067N	Massey Ferguson	Schlepper / 4000	4270			0	0	673	114	111	Block Type				
820387N	Massey Ferguson	Schlepper / 5000	5410			0	0	619	102	76					3909742M91
820387N	Massey Ferguson	Schlepper / 5000	5420			0	0	619	102	76					3909742M91
820387N	Massey Ferguson	Schlepper / 5000	5425			0	0	619	102	76					3909742M91
820387N	Massey Ferguson	Schlepper / 5000	5430			0	0	619	102	76					3909742M91
820387N	Massey Ferguson	Schlepper / 5000	5435			0	0	619	102	76					3909742M91
820387N	Massey Ferguson	Schlepper / 5000	5440			0	0	619	102	76					3909742M91
820387N	Massey Ferguson	Schlepper / 5000	5445			0	0	619	102	76					3909742M91
820387N	Massey Ferguson	Schlepper / 5000	5450			0	0	619	102	76					3909742M91
820387N	Massey Ferguson	Schlepper / 5000	5455			0	0	619	102	76					3909742M91
820387N	Massey Ferguson	Schlepper / 5000	5460			0	0	619	102	76					3909742M91
820387N	Massey Ferguson	Schlepper / 5000	5465			0	0	619	102	76					3909742M91
820387N	Massey Ferguson	Schlepper / 5000	5465 HI-Visibility			0	0	619	102	76					3909742M91
820387N	Massey Ferguson	Schlepper / 5000	5470			0	0	619	102	76					3909742M91
820387N	Massey Ferguson	Schlepper / 5000	5475			0	0	619	102	76					3909742M91
820387N	Massey Ferguson	Schlepper / 5000	5480			0	0	619	102	76					3909742M91

Dasis Nr.	Hersteller	Modell	Typ	Bj von	Bj bis	PS	ccmTech	Netzlänge [mm]	Netzbreite [mm]	Netztiefe [mm]	Ausstattungsvariante	Einlass-Ø [mm]	Auslass-Ø [mm]	Einbaudicke [mm]	für OE-Nummer
820092N	Massey Ferguson	Schlepper / 6000	6110			0	0	622	114	83	Block Type	14	14		
820092N	Massey Ferguson	Schlepper / 6000	6120			0	0	622	114	83	Block Type	14	14		
820092N	Massey Ferguson	Schlepper / 6000	6130			0	0	622	114	83	Block Type	14	14		
820092N	Massey Ferguson	Schlepper / 6000	6140			0	0	622	114	83	Block Type	14	14		
820092N	Massey Ferguson	Schlepper / 6000	6150			0	0	622	114	83	Block Type	14	14		
820092N	Massey Ferguson	Schlepper / 6000	6160			0	0	622	114	83	Block Type	14	14		
820092N	Massey Ferguson	Schlepper / 6000	6170			0	0	622	114	83	Block Type	14	14		
820092N	Massey Ferguson	Schlepper / 6000	6180			0	0	622	114	83	Block Type	14	14		
820092N	Massey Ferguson	Schlepper / 6000	6190			0	0	622	114	83	Block Type	14	14		
820092N	Massey Ferguson	Schlepper / 6000	6235			0	0	622	114	83	Block Type	14	14		
820092N	Massey Ferguson	Schlepper / 6000	6245			0	0	622	114	83	Block Type	14	14		
820092N	Massey Ferguson	Schlepper / 6000	6255			0	0	622	114	83	Block Type	14	14		
820092N	Massey Ferguson	Schlepper / 6000	6260			0	0	622	114	83	Block Type	14	14		
820092N	Massey Ferguson	Schlepper / 6000	6265			0	0	622	114	83	Block Type	14	14		
820092N	Massey Ferguson	Schlepper / 6000	6270			0	0	622	114	83	Block Type	14	14		
820092N	Massey Ferguson	Schlepper / 6000	6280			0	0	622	114	83	Block Type	14	14		
820092N	Massey Ferguson	Schlepper / 6000	6290			0	0	622	114	83	Block Type	14	14		
820092N	Massey Ferguson	Schlepper / 8000	8110			0	0	622	114	83	Block Type	14	14		
820092N	Massey Ferguson	Schlepper / 8000	8120			0	0	622	114	83	Block Type	14	14		
820092N	Massey Ferguson	Schlepper / 8000	8130			0	0	622	114	83	Block Type	14	14		
820092N	Massey Ferguson	Schlepper / 8000	8140			0	0	622	114	83	Block Type	14	14		

Dasis Nr.	Hersteller	Modell	Typ	Bj von	Bj bis	PS	ccmTech	Netzlänge [mm]	Netzbreite [mm]	Netztiefe [mm]	Ausstattungsvariante	Einlass-Ø [mm]	Auslass-Ø [mm]	Einbaudicke [mm]	für OE-Nummer
820092N	Massey Ferguson	Schlepper / 8000	8150			0	0	622	114	83	Block Type	14	14		
820092N	Massey Ferguson	Schlepper / 8000	8160			0	0	622	114	83	Block Type	14	14		
820092N	Massey Ferguson	Schlepper / 8000	8170			0	0	622	114	83	Block Type	14	14		
820092N	Massey Ferguson	Schlepper / 8000	8180			0	0	622	114	83	Block Type	14	14		
820092N	Massey Ferguson	Schlepper / 8000	8210			0	0	622	114	83	Block Type	14	14		
820092N	Massey Ferguson	Schlepper / 8000	8220			0	0	622	114	83	Block Type	14	14		
820092N	Massey Ferguson	Schlepper / 8000	8240			0	0	622	114	83	Block Type	14	14		
820092N	Massey Ferguson	Schlepper / 8000	8250			0	0	622	114	83	Block Type	14	14		
820092N	Massey Ferguson	Schlepper / 8000	8260			0	0	622	114	83	Block Type	14	14		
820092N	Massey Ferguson	Schlepper / 8000	8270			0	0	622	114	83	Block Type	14	14		
820092N	Massey Ferguson	Schlepper / 8000	8280			0	0	622	114	83	Block Type	14	14		
820295N	MC Cormick	Schlepper / CX	50			0	0	514	152	70					372500A1
820295N	MC Cormick	Schlepper / CX	60			0	0	514	152	70					372500A1
820295N	MC Cormick	Schlepper / CX	70			0	0	514	152	70					372500A1
820295N	MC Cormick	Schlepper / CX	75			0	0	514	152	70					372500A1
820295N	MC Cormick	Schlepper / CX	80			0	0	514	152	70					372500A1
820295N	MC Cormick	Schlepper / CX	85			0	0	514	152	70					372500A1
820295N	MC Cormick	Schlepper / CX	90			0	0	514	152	70					372500A1
820295N	MC Cormick	Schlepper / CX	95			0	0	514	152	70					372500A1
820295N	MC Cormick	Schlepper / CX	100			0	0	514	152	70					372500A1
820295N	MC Cormick	Schlepper / CX	105			0	0	514	152	70					372500A1
820295N	MC Cormick	Schlepper / CX	110			0	0	514	152	70					372500A1
820295N	MC Cormick	Schlepper / MC	80			0	0	514	152	70					372500A1
820295N	MC Cormick	Schlepper / MC	90			0	0	514	152	70					372500A1
820295N	MC Cormick	Schlepper / MC	95			0	0	514	152	70					372500A1
820295N	MC Cormick	Schlepper / MC	100			0	0	514	152	70					372500A1

Dasis Nr.	Hersteller	Modell	Typ	Bj von	Bj bis	PS	ccmTech	Netzlänge [mm]	Netzbreite [mm]	Netztiefe [mm]	Ausstattungsvariante	Einlass-Ø [mm]	Auslass-Ø [mm]	Einbaudicke [mm]	für OE-Nummer
820295N	MC Cormick	Schlepper / MC	105			0	0	514	152	70					372500A1
820295N	MC Cormick	Schlepper / MC	110			0	0	514	152	70					372500A1
820295N	MC Cormick	Schlepper / MC	115			0	0	514	152	70					372500A1
820295N	MC Cormick	Schlepper / MC	120			0	0	514	152	70					372500A1
820295N	MC Cormick	Schlepper / MC	130			0	0	514	152	70					372500A1
820295N	MC Cormick	Schlepper / MC	135			0	0	514	152	70					372500A1
820992N	NEW HOLLAND	Baggerlader / 550-575E	555E			0	0	325	229	73					
820992N	NEW HOLLAND	Baggerlader / 550-575E	575E			0	0	325	229	73					
820992N	NEW HOLLAND	Baggerlader / 655-755A	655E			0	0	325	229	73					
820992N	NEW HOLLAND	Baggerlader / 655-755A	675E			0	0	325	229	73					
821882N	NEW HOLLAND	Baggerlader / C Serie	C175			0	0	360	160	110					87350424
821882N	NEW HOLLAND	Baggerlader / C Serie	C185			0	0	360	160	110					87350424
820416N	NEW HOLLAND	Baggerlader / E Serie	70BSR			0	0	1	1	1					YN20M001075020
820416N	NEW HOLLAND	Baggerlader / E Serie	75CSR			0	0	1	1	1					YN20M001075020
820416N	NEW HOLLAND	Baggerlader / E Serie	80BMSR			0	0	1	1	1					YN20M001075020
820416N	NEW HOLLAND	Baggerlader / E Serie	85CMSR			0	0	1	1	1					YN20M001075020
820416N	NEW HOLLAND	Baggerlader / E Serie	135B			0	0	1	1	1					YN20M001075020
820416N	NEW HOLLAND	Baggerlader / E Serie	135BSR			0	0	1	1	1					YN20M001075020
820416N	NEW HOLLAND	Baggerlader / E Serie	140CSR			0	0	1	1	1					YN20M001075020
820416N	NEW HOLLAND	Baggerlader / E Serie	150BSR			0	0	1	1	1					YN20M001075020
820416N	NEW HOLLAND	Baggerlader / E Serie	160CBR			0	0	1	1	1					YN20M001075020
820416N	NEW HOLLAND	Baggerlader / E Serie	175B-C			0	0	1	1	1					YN20M001075020
820416N	NEW HOLLAND	Baggerlader / E Serie	195B			0	0	1	1	1					YN20M001075020

Dasis Nr.	Hersteller	Modell	Typ	Bj von	Bj bis	PS	ccmTech	Netzlänge [mm]	Netzbreite [mm]	Netztiefe [mm]	Ausstattungsvariante	Einlass-Ø [mm]	Auslass-Ø [mm]	Einbaudicke [mm]	für OE-Nummer
820416N	NEW HOLLAND	Baggerlader / E Serie	215B			0	0	1	1	1					YN20M001075020
820416N	NEW HOLLAND	Baggerlader / E Serie	215B-C			0	0	1	1	1					YN20M001075020
820416N	NEW HOLLAND	Baggerlader / E Serie	215BJ			0	0	1	1	1					YN20M001075020
820416N	NEW HOLLAND	Baggerlader / E Serie	225BSR			0	0	1	1	1					YN20M001075020
820416N	NEW HOLLAND	Baggerlader / E Serie	225BSRLC			0	0	1	1	1					YN20M001075020
820416N	NEW HOLLAND	Baggerlader / E Serie	230CSR			0	0	1	1	1					YN20M001075020
820416N	NEW HOLLAND	Baggerlader / E Serie	230CSRLC			0	0	1	1	1					YN20M001075020
820992N	NEW HOLLAND	Baggerlader / LB	75			0	0	325	229	73					
820992N	NEW HOLLAND	Baggerlader / LB	85			0	0	325	229	73					
820992N	NEW HOLLAND	Baggerlader / LB	90			0	0	325	229	73					
820992N	NEW HOLLAND	Baggerlader / LB	95			0	0	325	229	73					
820992N	NEW HOLLAND	Baggerlader / LB	110			0	0	325	229	73					
820992N	NEW HOLLAND	Baggerlader / LB	115			0	0	325	229	73					
820992N	NEW HOLLAND	Baggerlader / NH	75			0	0	325	229	73					
820992N	NEW HOLLAND	Baggerlader / NH	85			0	0	325	229	73					
820992N	NEW HOLLAND	Baggerlader / NH	95			0	0	325	229	73					
821882N	NEW HOLLAND	Baggerlader LT Serie	185B			0	0	360	160	110					87350424
821882N	NEW HOLLAND	Baggerlader LT Serie	190B			0	0	360	160	110					87350424
820070N	NEW HOLLAND	Mähdrescher / 8000	8030			0	0	1	1	1					
820070N	NEW HOLLAND	Mähdrescher / 8000	8040			0	0	1	1	1					
820070N	NEW HOLLAND	Mähdrescher / 8000	8050			0	0	1	1	1					
820070N	NEW HOLLAND	Mähdrescher / 8000	8055			0	0	1	1	1					
820070N	NEW HOLLAND	Mähdrescher / 8000	8060			0	0	1	1	1					
820070N	NEW HOLLAND	Mähdrescher / 8000	8070			0	0	1	1	1					

Dasis Nr.	Hersteller	Modell	Typ	Bj von	Bj bis	PS	ccmTech	Netzlänge [mm]	Netzbreite [mm]	Netztiefe [mm]	Ausstattungsvariante	Einlass-Ø [mm]	Auslass-Ø [mm]	Einbaudicke [mm]	für OE-Nummer
820070N	NEW HOLLAND	Mähdrescher / 8000	8080			0	0	1	1	1					
820179N	NEW HOLLAND	Mähdrescher / CSX	7040			0	0	635	152	64					87541273
820179N	NEW HOLLAND	Mähdrescher / CSX	7050			0	0	635	152	64					87541273
820179N	NEW HOLLAND	Mähdrescher / CSX	7050H			0	0	635	152	64					87541273
820179N	NEW HOLLAND	Mähdrescher / CSX	7060			0	0	635	152	64					87541273
820179N	NEW HOLLAND	Mähdrescher / CSX	7070			0	0	635	152	64					87541273
820179N	NEW HOLLAND	Mähdrescher / FR / Forage	450			0	0	635	152	64					87541273
820179N	NEW HOLLAND	Mähdrescher / FR / Forage	500			0	0	635	152	64					87541273
820179N	NEW HOLLAND	Mähdrescher / FR / Forage	600			0	0	635	152	64					87541273
820179N	NEW HOLLAND	Mähdrescher / FR / Forage	700			0	0	635	152	64					87541273
820179N	NEW HOLLAND	Mähdrescher / FR / Forage	850			0	0	635	152	64					87541273
820179N	NEW HOLLAND	Mähdrescher / FR / Forage	9040			0	0	635	152	64					87541273
820179N	NEW HOLLAND	Mähdrescher / FR / Forage	9050			0	0	635	152	64					87541273
820179N	NEW HOLLAND	Mähdrescher / FR / Forage	9060			0	0	635	152	64					87541273
820179N	NEW HOLLAND	Mähdrescher / FR / Forage	9080			0	0	635	152	64					87541273
820179N	NEW HOLLAND	Mähdrescher / FR / Forage	9090			0	0	635	152	64					87541273
820179N	NEW HOLLAND	Mähdrescher / Grape	7030M			0	0	635	152	64					87541273
820179N	NEW HOLLAND	Mähdrescher / Grape	8030L			0	0	635	152	64					87541273
820179N	NEW HOLLAND	Mähdrescher / Grape	9040L			0	0	635	152	64					87541273
820179N	NEW HOLLAND	Mähdrescher / Grape	9040M			0	0	635	152	64					87541273
820179N	NEW HOLLAND	Mähdrescher / Grape	9050L			0	0	635	152	64					87541273

Dasis Nr.	Hersteller	Modell	Typ	Bj von	Bj bis	PS	ccmTech	Netzlänge [mm]	Netzbreite [mm]	Netztiefe [mm]	Ausstattungsvariante	Einlass-Ø [mm]	Auslass-Ø [mm]	Einbaudicke [mm]	für OE-Nummer
820179N	NEW HOLLAND	Mähdrescher / Grape	9060L			0	0	635	152	64					87541273
820179N	NEW HOLLAND	Mähdrescher / Grape	9070L			0	0	635	152	64					87541273
820179N	NEW HOLLAND	Mähdrescher / Grape	9070M			0	0	635	152	64					87541273
820179N	NEW HOLLAND	Mähdrescher / Grape	9080N			0	0	635	152	64					87541273
820179N	NEW HOLLAND	Mähdrescher / Grape	9090L			0	0	635	152	64					87541273
820179N	NEW HOLLAND	Mähdrescher / Grape	9090X			0	0	635	152	64					87541273
820179N	NEW HOLLAND	Mähdrescher / Grape	VL530			0	0	635	152	64					87541273
820179N	NEW HOLLAND	Mähdrescher / Grape	VL540			0	0	635	152	64					87541273
820179N	NEW HOLLAND	Mähdrescher / Grape	VL550			0	0	635	152	64					87541273
820179N	NEW HOLLAND	Mähdrescher / Grape	VL600			0	0	635	152	64					87541273
820179N	NEW HOLLAND	Mähdrescher / Grape	VL610			0	0	635	152	64					87541273
820179N	NEW HOLLAND	Mähdrescher / Grape	VL620			0	0	635	152	64					87541273
820179N	NEW HOLLAND	Mähdrescher / Grape	VL630			0	0	635	152	64					87541273
820179N	NEW HOLLAND	Mähdrescher / Grape	VL640			0	0	635	152	64					87541273
820179N	NEW HOLLAND	Mähdrescher / Grape	VL660			0	0	635	152	64					87541273
820179N	NEW HOLLAND	Mähdrescher / Grape	VL5060			0	0	635	152	64					87541273
820179N	NEW HOLLAND	Mähdrescher / Grape	VL5080			0	0	635	152	64					87541273
820179N	NEW HOLLAND	Mähdrescher / Grape	VL5090			0	0	635	152	64					87541273
820291N	NEW HOLLAND	Schlepper / 2110-8210	2310			0	0	483	152	111					
820291N	NEW HOLLAND	Schlepper / 2110-8210	2610			0	0	483	152	111					
820291N	NEW HOLLAND	Schlepper / 2110-8210	2810			0	0	483	152	111					

Dasis Nr.	Hersteller	Modell	Typ	Bj von	Bj bis	PS	ccmTech	Netzlänge [mm]	Netzbreite [mm]	Netztiefe [mm]	Ausstattungsvariante	Einlass-Ø [mm]	Auslass-Ø [mm]	Einbaudicke [mm]	für OE-Nummer
820291N	NEW HOLLAND	Schlepper / 2110-8210	2910			0	0	483	152	111					
820291N	NEW HOLLAND	Schlepper / 2110-8210	3310			0	0	483	152	111					
820291N	NEW HOLLAND	Schlepper / 2110-8210	3610			0	0	483	152	111					
820291N	NEW HOLLAND	Schlepper / 2110-8210	3910			0	0	483	152	111					
820291N	NEW HOLLAND	Schlepper / 2110-8210	4110			0	0	483	152	111					
820291N	NEW HOLLAND	Schlepper / 2110-8210	4610			0	0	483	152	111					
820291N	NEW HOLLAND	Schlepper / 2110-8210	5110			0	0	483	152	111					
820291N	NEW HOLLAND	Schlepper / 2110-8210	5610			0	0	483	152	111					
820291N	NEW HOLLAND	Schlepper / 2110-8210	5710			0	0	483	152	111					
820291N	NEW HOLLAND	Schlepper / 2110-8210	5900			0	0	483	152	111					
820291N	NEW HOLLAND	Schlepper / 2110-8210	6410			0	0	483	152	111					
820291N	NEW HOLLAND	Schlepper / 2110-8210	6610			0	0	483	152	111					
820291N	NEW HOLLAND	Schlepper / 2110-8210	6710			0	0	483	152	111					
820291N	NEW HOLLAND	Schlepper / 2110-8210	6810			0	0	483	152	111					
820291N	NEW HOLLAND	Schlepper / 2110-8210	7410			0	0	483	152	111					
820291N	NEW HOLLAND	Schlepper / 2110-8210	7610			0	0	483	152	111					
820291N	NEW HOLLAND	Schlepper / 2110-8210	7710			0	0	483	152	111					
820291N	NEW HOLLAND	Schlepper / 2110-8210	7810			0	0	483	152	111					
820291N	NEW HOLLAND	Schlepper / 2110-8210	7910			0	0	483	152	111					
820291N	NEW HOLLAND	Schlepper / 2110-8210	8210			0	0	483	152	111					
820097N	NEW HOLLAND	Schlepper / 3435-7635	3435			0	0	622	95	83	Block Type				



Dasis Nr.	Hersteller	Modell	Typ	Bj von	Bj bis	PS	ccmTech	Netzlänge [mm]	Netzbreite [mm]	Netztiefe [mm]	Ausstattungsvariante	Einlass-Ø [mm]	Auslass-Ø [mm]	Einbaudicke [mm]	für OE-Nummer
820097N	NEW HOLLAND	Schlepper / 3435-7635	3935			0	0	622	95	83	Block Type				
820097N	NEW HOLLAND	Schlepper / 3435-7635	4135			0	0	622	95	83	Block Type				
820097N	NEW HOLLAND	Schlepper / 3435-7635	4635			0	0	622	95	83	Block Type				
820097N	NEW HOLLAND	Schlepper / 3435-7635	4835			0	0	622	95	83	Block Type				
820097N	NEW HOLLAND	Schlepper / 3435-7635	5635			0	0	622	95	83	Block Type				
820097N	NEW HOLLAND	Schlepper / 3435-7635	6635			0	0	622	95	83	Block Type				
820097N	NEW HOLLAND	Schlepper / 3435-7635	7635			0	0	622	95	83	Block Type				
820291N	NEW HOLLAND	Schlepper /4110-8210	5110			0	0	483	152	111					
820291N	NEW HOLLAND	Schlepper /4110-8210	5610			0	0	483	152	111					
820291N	NEW HOLLAND	Schlepper /4110-8210	6410			0	0	483	152	111					
820291N	NEW HOLLAND	Schlepper /4110-8210	6610			0	0	483	152	111					
820291N	NEW HOLLAND	Schlepper /4110-8210	6810			0	0	483	152	111					
820291N	NEW HOLLAND	Schlepper /4110-8210	7410			0	0	483	152	111					
820291N	NEW HOLLAND	Schlepper /4110-8210	7610			0	0	483	152	111					
820291N	NEW HOLLAND	Schlepper /4110-8210	7710			0	0	483	152	111					
820291N	NEW HOLLAND	Schlepper /4110-8210	7810			0	0	483	152	111					
820291N	NEW HOLLAND	Schlepper /4110-8210	7910			0	0	483	152	111					
820291N	NEW HOLLAND	Schlepper /4110-8210	8210			0	0	483	152	111					
820284N	NEW HOLLAND	Schlepper / 4140-8340	5640			0	0	648	127	79	Block Type				
820284N	NEW HOLLAND	Schlepper / 4140-8340	6640			0	0	648	127	79	Block Type				
820284N	NEW HOLLAND	Schlepper / 4140-8340	7740			0	0	648	127	79	Block Type				

Dasis Nr.	Hersteller	Modell	Typ	Bj von	Bj bis	PS	ccmTech	Netzlänge [mm]	Netzbreite [mm]	Netztiefe [mm]	Ausstattungsvariante	Einlass-Ø [mm]	Auslass-Ø [mm]	Einbaudicke [mm]	für OE-Nummer
820284N	NEW HOLLAND	Schlepper / 4140-8340	7840			0	0	648	127	79	Block Type				
820284N	NEW HOLLAND	Schlepper / 4140-8340	8240			0	0	648	127	79	Block Type				
820284N	NEW HOLLAND	Schlepper / 4140-8340	8340			0	0	648	127	79	Block Type				
820284N	NEW HOLLAND	Schlepper / 8160-8560	8160			0	0	648	127	79	Block Type				
820284N	NEW HOLLAND	Schlepper / 8160-8560	8260			0	0	648	127	79	Block Type				
820284N	NEW HOLLAND	Schlepper / 8160-8560	8360			0	0	648	127	79	Block Type				
820284N	NEW HOLLAND	Schlepper / 8160-8560	8560			0	0	648	127	79	Block Type				
821887N	NEW HOLLAND	Schlepper / T	7510			0	0	390	127	76					134784255
821887N	NEW HOLLAND	Schlepper / T	7520			0	0	390	127	76					134784255
821887N	NEW HOLLAND	Schlepper / T	7530			0	0	390	127	76					134784255
821887N	NEW HOLLAND	Schlepper / T	7540			0	0	390	127	76					134784255
821887N	NEW HOLLAND	Schlepper / T	7550			0	0	390	127	76					134784255
821893N	NEW HOLLAND	Schlepper / T4 Serie	4.65V			0	0	330	133	83					47134607
821893N	NEW HOLLAND	Schlepper / T4 Serie	4.75F			0	0	330	133	83					47134607
821893N	NEW HOLLAND	Schlepper / T4 Serie	4.75N			0	0	330	133	83					47134607
821893N	NEW HOLLAND	Schlepper / T4 Serie	4.75V			0	0	330	133	83					47134607
821893N	NEW HOLLAND	Schlepper / T4 Serie	4.85F			0	0	330	133	83					47134607
821893N	NEW HOLLAND	Schlepper / T4 Serie	4.85N			0	0	330	133	83					47134607
821893N	NEW HOLLAND	Schlepper / T4 Serie	4.85V			0	0	330	133	83					47134607
821893N	NEW HOLLAND	Schlepper / T4 Serie	4.95F			0	0	330	133	83					47134607
821893N	NEW HOLLAND	Schlepper / T4 Serie	4.95N			0	0	330	133	83					47134607
821893N	NEW HOLLAND	Schlepper / T4 Serie	4.95V			0	0	330	133	83					47134607
821893N	NEW HOLLAND	Schlepper / T4 Serie	4.105F			0	0	330	133	83					47134607

Dasis Nr.	Hersteller	Modell	Typ	Bj von	Bj bis	PS	ccmTech	Netzlänge [mm]	Netzbreite [mm]	Netztiefe [mm]	Ausstattungsvariante	Einlass-Ø [mm]	Auslass-Ø [mm]	Einbaudicke [mm]	für OE-Nummer
821893N	NEW HOLLAND	Schlepper / T4 Serie	4.105N			0	0	330	133	83					47134607
821893N	NEW HOLLAND	Schlepper / T4 Serie	4.105V			0	0	330	133	83					47134607
821893N	NEW HOLLAND	Schlepper / T4000 Serie	4020			0	0	330	133	83					47134607
821893N	NEW HOLLAND	Schlepper / T4000 Serie	4020V			0	0	330	133	83					47134607
821893N	NEW HOLLAND	Schlepper / T4000 Serie	4030			0	0	330	133	83					47134607
821893N	NEW HOLLAND	Schlepper / T4000 Serie	4030F			0	0	330	133	83					47134607
821893N	NEW HOLLAND	Schlepper / T4000 Serie	4030N			0	0	330	133	83					47134607
821893N	NEW HOLLAND	Schlepper / T4000 Serie	4030V			0	0	330	133	83					47134607
821893N	NEW HOLLAND	Schlepper / T4000 Serie	4040			0	0	330	133	83					47134607
821893N	NEW HOLLAND	Schlepper / T4000 Serie	4040F			0	0	330	133	83					47134607
821893N	NEW HOLLAND	Schlepper / T4000 Serie	4040N			0	0	330	133	83					47134607
821893N	NEW HOLLAND	Schlepper / T4000 Serie	4040V			0	0	330	133	83					47134607
821893N	NEW HOLLAND	Schlepper / T4000 Serie	4050			0	0	330	133	83					47134607
821893N	NEW HOLLAND	Schlepper / T4000 Serie	4050F			0	0	330	133	83					47134607
821893N	NEW HOLLAND	Schlepper / T4000 Serie	4060			0	0	330	133	83					47134607
821893N	NEW HOLLAND	Schlepper / T4000 Serie	4060F			0	0	330	133	83					47134607
821893N	NEW HOLLAND	Schlepper / T4000 Serie	4060N			0	0	330	133	83					47134607
821893N	NEW HOLLAND	Schlepper / T4000 Serie	4060V			0	0	330	133	83					47134607
821892N	NEW HOLLAND	Schlepper / TG	210			0	0	413	267	110	mit Heizungskuehler				
821892N	NEW HOLLAND	Schlepper / TG	230			0	0	413	267	110	mit Heizungskuehler				
821892N	NEW HOLLAND	Schlepper / TG	255			0	0	413	267	110	mit Heizungskuehler				
821892N	NEW HOLLAND	Schlepper / TG	285			0	0	413	267	110	mit Heizungskuehler				
821893N	NEW HOLLAND	Schlepper / TK	4040			0	0	330	133	83					47134607

Dasis Nr.	Hersteller	Modell	Typ	Bj von	Bj bis	PS	ccmTech	Netzlänge [mm]	Netzbreite [mm]	Netztiefe [mm]	Ausstattungsvariante	Einlass-Ø [mm]	Auslass-Ø [mm]	Einbaudicke [mm]	für OE-Nummer
821893N	NEW HOLLAND	Schlepper / TK	4040M			0	0	330	133	83					47134607
821893N	NEW HOLLAND	Schlepper / TK	4050			0	0	330	133	83					47134607
821893N	NEW HOLLAND	Schlepper / TK	4050M			0	0	330	133	83					47134607
821893N	NEW HOLLAND	Schlepper / TK	4060			0	0	330	133	83					47134607
820284N	NEW HOLLAND	Schlepper / TM	TM115			0	0	648	127	79	Block Type				
820285N	NEW HOLLAND	Schlepper / TM	TM115			0	0	648	127	79	Block Type				
820284N	NEW HOLLAND	Schlepper / TM	TM120			0	0	648	127	79	Block Type				
820285N	NEW HOLLAND	Schlepper / TM	TM120			0	0	648	127	79	Block Type				
820284N	NEW HOLLAND	Schlepper / TM	TM125			0	0	648	127	79	Block Type				
820285N	NEW HOLLAND	Schlepper / TM	TM125			0	0	648	127	79	Block Type				
820285N	NEW HOLLAND	Schlepper / TM	TM130			0	0	648	127	79	Block Type				
820284N	NEW HOLLAND	Schlepper / TM	TM130			0	0	648	127	79	Block Type				
820284N	NEW HOLLAND	Schlepper / TM	TM135			0	0	648	127	79	Block Type				
820285N	NEW HOLLAND	Schlepper / TM	TM135			0	0	648	127	79	Block Type				
820284N	NEW HOLLAND	Schlepper / TM	TM140			0	0	648	127	79	Block Type				
820285N	NEW HOLLAND	Schlepper / TM	TM140			0	0	648	127	79	Block Type				
820284N	NEW HOLLAND	Schlepper / TM	TM150			0	0	648	127	79	Block Type				
820285N	NEW HOLLAND	Schlepper / TM	TM150			0	0	648	127	79	Block Type				
820284N	NEW HOLLAND	Schlepper / TM	TM155			0	0	648	127	79	Block Type				
820285N	NEW HOLLAND	Schlepper / TM	TM155			0	0	648	127	79	Block Type				
820285N	NEW HOLLAND	Schlepper / TM	TM165			0	0	648	127	79	Block Type				
820284N	NEW HOLLAND	Schlepper / TM	TM165			0	0	648	127	79	Block Type				
820284N	NEW HOLLAND	Schlepper / TM	TM175			0	0	648	127	79	Block Type				
820285N	NEW HOLLAND	Schlepper / TM	TM175			0	0	648	127	79	Block Type				
820284N	NEW HOLLAND	Schlepper / TM	TM190			0	0	648	127	79	Block Type				
820285N	NEW HOLLAND	Schlepper / TM	TM190			0	0	648	127	79	Block Type				
821888N	NEW HOLLAND	Schlepper / TN	55V			0	0	340	133	83					
821893N	NEW HOLLAND	Schlepper / TN	60VA			0	0	330	133	83					47134607
821888N	NEW HOLLAND	Schlepper / TN	65N			0	0	340	133	83					
821888N	NEW HOLLAND	Schlepper / TN	65V			0	0	340	133	83					
821893N	NEW HOLLAND	Schlepper / TN	70NA			0	0	330	133	83					47134607

Dasis Nr.	Hersteller	Modell	Typ	Bj von	Bj bis	PS	ccmTech	Netzlänge [mm]	Netzbreite [mm]	Netztiefe [mm]	Ausstattungsvariante	Einlass-Ø [mm]	Auslass-Ø [mm]	Einbaudicke [mm]	für OE-Nummer
821893N	NEW HOLLAND	Schlepper / TN	70VA			0	0	330	133	83					47134607
821893N	NEW HOLLAND	Schlepper / TN	75FA			0	0	330	133	83					47134607
821888N	NEW HOLLAND	Schlepper / TN	75N			0	0	340	133	83					
821893N	NEW HOLLAND	Schlepper / TN	75NA			0	0	330	133	83					47134607
821888N	NEW HOLLAND	Schlepper / TN	75NA			0	0	340	133	83					
821888N	NEW HOLLAND	Schlepper / TN	75V			0	0	340	133	83					
821893N	NEW HOLLAND	Schlepper / TN	85FA			0	0	330	133	83					47134607
821893N	NEW HOLLAND	Schlepper / TN	95FA			0	0	330	133	83					47134607
821893N	NEW HOLLAND	Schlepper / TN	95NA			0	0	330	133	83					47134607
821888N	NEW HOLLAND	Schlepper / TN	95NA			0	0	340	133	83					
821893N	NEW HOLLAND	Schlepper / TN	95VA			0	0	330	133	83					47134607
821893N	NEW HOLLAND	Schlepper / TN	Compact			0	0	330	133	83					47134607
820094N	NEW HOLLAND	Schlepper / TS	100			0	0	470	127	95	Block Type	12	9,2		
820094N	NEW HOLLAND	Schlepper / TS	110			0	0	470	127	95	Block Type	12	9,2		
820094N	NEW HOLLAND	Schlepper / TS	115			0	0	470	127	95	Block Type	12	9,2		
820094N	NEW HOLLAND	Schlepper / TSA	100A			0	0	470	127	95	Block Type	12	9,2		
820094N	NEW HOLLAND	Schlepper / TSA	110A			0	0	470	127	95	Block Type	12	9,2		
820094N	NEW HOLLAND	Schlepper / TSA	115A			0	0	470	127	95	Block Type	12	9,2		
820094N	NEW HOLLAND	Schlepper / TSA	125A			0	0	470	127	95	Block Type	12	9,2		
820094N	NEW HOLLAND	Schlepper / TSA	135A			0	0	470	127	95	Block Type	12	9,2		
820292N	NEW HOLLAND	Schlepper / TW5	5			0	0	483	152	114					
820292N	NEW HOLLAND	Schlepper / TW5	15			0	0	483	152	114					
820292N	NEW HOLLAND	Schlepper / TW5	25			0	0	483	152	114					
820292N	NEW HOLLAND	Schlepper / TW5	35			0	0	483	152	114					
820292N	NEW HOLLAND	Schlepper Wein Obst / TW	5			0	0	483	152	114					
820292N	NEW HOLLAND	Schlepper Wein Obst / TW	25			0	0	483	152	114					
820292N	NEW HOLLAND	Schlepper Wein Obst / TW	30			0	0	483	152	114					
820292N	NEW HOLLAND	Schlepper Wein Obst / TW	35			0	0	483	152	114					
821881N	PORSCHE	356 Coupe	B 1600 Super 90	1947 09	1968 03	90	1582	197	305	38					3639453

Dasis Nr.	Hersteller	Modell	Typ	Bj von	Bj bis	PS	ccmTech	Netzlänge [mm]	Netzbreite [mm]	Netztiefe [mm]	Ausstattungsvariante	Einlass-Ø [mm]	Auslass-Ø [mm]	Einbaudicke [mm]	für OE-Nummer
820296N	Renault	Schlepper / Ares 500	531S			0	0								
820296N	Renault	Schlepper / Ares 500	540			0	0								
820296N	Renault	Schlepper / Ares 500	546			0	0								
820296N	Renault	Schlepper / Ares 500	550			0	0								
820296N	Renault	Schlepper / Ares 500	556			0	0								
820296N	Renault	Schlepper / Ares 500	560			0	0								
820296N	Renault	Schlepper / Ares 500	566			0	0								
820296N	Renault	Schlepper / Ares 600	610			0	0								
820296N	Renault	Schlepper / Ares 600	616			0	0								
820296N	Renault	Schlepper / Ares 600	620			0	0								
820296N	Renault	Schlepper / Ares 600	626			0	0								
820296N	Renault	Schlepper / Ares 600	630			0	0								
820296N	Renault	Schlepper / Ares 600	636			0	0								
820296N	Renault	Schlepper / Ares 600	640			0	0								
820296N	Renault	Schlepper / Ares 600	696			0	0								
820296N	Renault	Schlepper / Ares 700	710			0	0								
820296N	Renault	Schlepper / Ares 700	715			0	0								
820296N	Renault	Schlepper / Ares 700	720			0	0								
820296N	Renault	Schlepper / Ares 700	725			0	0								
820296N	Renault	Schlepper / Ares 700	735			0	0								
820296N	Renault	Schlepper / Ares 800	815			0	0								

Dasis Nr.	Hersteller	Modell	Typ	Bj von	Bj bis	PS	ccmTech	Netzlänge [mm]	Netzbreite [mm]	Netztiefe [mm]	Ausstattungsvariante	Einlass-Ø [mm]	Auslass-Ø [mm]	Einbaudicke [mm]	für OE-Nummer
820296N	Renault	Schlepper / Ares 800	816			0	0								
820296N	Renault	Schlepper / Ares 800	825			0	0								
820296N	Renault	Schlepper / Ares 800	826			0	0								
820296N	Renault	Schlepper / Ares 800	836			0	0								
820093N	Renault	Schlepper / ME	58-32ME			0	0								
820093N	Renault	Schlepper / ME	58-34ME			0	0								
820093N	Renault	Schlepper / ME	65-32ME			0	0								
820093N	Renault	Schlepper / ME	65-34ME			0	0								
820093N	Renault	Schlepper / ME	75-12ME			0	0								
820093N	Renault	Schlepper / ME	75-32ME			0	0								
820093N	Renault	Schlepper / ME	75-34ME			0	0								
820093N	Renault	Schlepper / ME	85-32ME			0	0								
820093N	Renault	Schlepper / ME	85-34ME			0	0								
820093N	Renault	Schlepper / ME	90-32ME			0	0								
820093N	Renault	Schlepper / ME	90-34ME			0	0								
820093N	Renault	Schlepper / ME	110-14ME			0	0								
820093N	Renault	Schlepper / ME	120-14ME			0	0								
820093N	Renault	Schlepper / ME	133-14ME			0	0								
820093N	Renault	Schlepper / ME	145-14ME			0	0								
820093N	Renault	Schlepper / RE	95-12RE			0	0								
820093N	Renault	Schlepper / RE	95-14RE			0	0								
820093N	Renault	Schlepper / RE	103-12RE			0	0								
820093N	Renault	Schlepper / RE	103-14RE			0	0								
820093N	Renault	Schlepper / RE	110-14RE			0	0								
820093N	Renault	Schlepper / RE	113-12RE			0	0								
820093N	Renault	Schlepper / RE	113-14RE			0	0								
820093N	Renault	Schlepper / RE	120-14RE			0	0								
820093N	Renault	Schlepper / RE	133-14RE			0	0								
820092N	Renault	Schlepper / RE	133-14RE			0	0	622	114	83	Block Type	14	14		
820093N	Renault	Schlepper / RE	145-14RE			0	0								

Dasis Nr.	Hersteller	Modell	Typ	Bj von	Bj bis	PS	ccmTech	Netzlänge [mm]	Netzbreite [mm]	Netztiefe [mm]	Ausstattungsvariante	Einlass-Ø [mm]	Auslass-Ø [mm]	Einbaudicke [mm]	für OE-Nummer
820093N	Renault	Schlepper / TA	103-52			0	0								
820093N	Renault	Schlepper / TA	103-54			0	0								
820093N	Renault	Schlepper / TA	110-14			0	0								
820093N	Renault	Schlepper / TA	110-54			0	0								
820093N	Renault	Schlepper / TA	120-14			0	0								
820093N	Renault	Schlepper / TA	120-54			0	0								
820093N	Renault	Schlepper / TA	133-14			0	0								
820093N	Renault	Schlepper / TA	133-54			0	0								
820093N	Renault	Schlepper / TA	145-14			0	0								
820093N	Renault	Schlepper / TA	145-54			0	0								
820093N	Renault	Schlepper / TA	155-54			0	0								
820093N	Renault	Schlepper / TE	103-52TE			0	0								
820093N	Renault	Schlepper / TE	103-54TE			0	0								
820093N	Renault	Schlepper / TE	110-14TE			0	0								
820093N	Renault	Schlepper / TE	110-54TE			0	0								
820093N	Renault	Schlepper / TE	120-14TE			0	0								
820093N	Renault	Schlepper / TE	120-54TE			0	0								
820093N	Renault	Schlepper / TE	133-14TE			0	0								
820093N	Renault	Schlepper / TE	133-54TE			0	0								
820093N	Renault	Schlepper / TE	145-14TE			0	0								
820093N	Renault	Schlepper / TE	145-54TE			0	0								
820093N	Renault	Schlepper / TE	155-54TE			0	0								
820093N	Renault	Schlepper / TS	75-12			0	0								
820093N	Renault	Schlepper / TS	75-14			0	0								
820093N	Renault	Schlepper / TS	77-12			0	0								
820093N	Renault	Schlepper / TS	77-14			0	0								
820093N	Renault	Schlepper / TS	85-12			0	0								
820093N	Renault	Schlepper / TS	85-14			0	0								
820093N	Renault	Schlepper / TS	95-12			0	0								
820093N	Renault	Schlepper / TS	95-14			0	0								
820093N	Renault	Schlepper / TS	110-54			0	0								



Dasis Nr.	Hersteller	Modell	Typ	Bj von	Bj bis	PS	ccmTech	Netzlänge [mm]	Netzbreite [mm]	Netztiefe [mm]	Ausstattungsvariante	Einlass-Ø [mm]	Auslass-Ø [mm]	Einbaudicke [mm]	für OE-Nummer
820093N	Renault	Schlepper / TS	120-54			0	0								
820093N	Renault	Schlepper / TS	133-12			0	0								
820093N	Renault	Schlepper / TS	133-14			0	0								
820093N	Renault	Schlepper / TS	133-54			0	0								
820093N	Renault	Schlepper / TX	75-32TX			0	0								
820130N	Renault	Schlepper / TX	75-32TX			0	0	220	266	100					80210SE0A01
820093N	Renault	Schlepper / TX	75-34TX			0	0								
820130N	Renault	Schlepper / TX	75-34TX			0	0	220	266	100					80210SE0A01
820093N	Renault	Schlepper / TX	80-12TX			0	0								
820130N	Renault	Schlepper / TX	80-12TX			0	0	220	266	100					80210SE0A01
820093N	Renault	Schlepper / TX	80-14TX			0	0								
820130N	Renault	Schlepper / TX	80-14TX			0	0	220	266	100					80210SE0A01
820093N	Renault	Schlepper / TX	85-12TX			0	0								
820130N	Renault	Schlepper / TX	85-12TX			0	0	220	266	100					80210SE0A01
820093N	Renault	Schlepper / TX	85-14TX			0	0								
820093N	Renault	Schlepper / TX	85-32TX			0	0								
820093N	Renault	Schlepper / TX	85-34TX			0	0								
820093N	Renault	Schlepper / TX	90-32TX			0	0								
820093N	Renault	Schlepper / TX	90-34TX			0	0								
820093N	Renault	Schlepper / TX	95-12TX			0	0								
820093N	Renault	Schlepper / TX	95-14TX			0	0								
820093N	Renault	Schlepper / TX	103-12TX			0	0								
820093N	Renault	Schlepper / TX	103-14TX			0	0								
820093N	Renault	Schlepper / TX	103-52TX			0	0								
820093N	Renault	Schlepper / TX	103-54TX			0	0								
820093N	Renault	Schlepper / TX	106-54TX			0	0								
820093N	Renault	Schlepper / TX	110-14TX			0	0								
820093N	Renault	Schlepper / TX	110-54TX			0	0								
820093N	Renault	Schlepper / TX	113-12TX			0	0								
820093N	Renault	Schlepper / TX	113-14TX			0	0								
820093N	Renault	Schlepper / TX	120-14TX			0	0								

Dasis Nr.	Hersteller	Modell	Typ	Bj von	Bj bis	PS	ccmTech	Netzlänge [mm]	Netzbreite [mm]	Netztiefe [mm]	Ausstattungsvariante	Einlass-Ø [mm]	Auslass-Ø [mm]	Einbaudicke [mm]	für OE-Nummer
820093N	Renault	Schlepper / TX	120-54TX			0	0								
820093N	Renault	Schlepper / TX	133-12TX			0	0								
820093N	Renault	Schlepper / TX	133-14TX			0	0								
820093N	Renault	Schlepper / TX	133-54TX			0	0								
820093N	Renault	Schlepper / TX	145-14TX			0	0								
820093N	Renault	Schlepper / TX	145-54TX			0	0								
820093N	Renault	Schlepper / TZ	110-54TZ			0	0								
820093N	Renault	Schlepper / TZ	133-54TZ			0	0								
820093N	Renault	Schlepper / TZ	145-14TZ			0	0								
820093N	Renault	Schlepper / TZ	145-54TZ			0	0								
820093N	Renault	Schlepper / TZ	155-54TZ			0	0								
820093N	Renault	Schlepper / TZ	160-94TZ			0	0								
820093N	Renault	Schlepper / TZ	175-74TZ			0	0								
820093N	Renault	Schlepper / TZ	180-94TZ			0	0								
820093N	Renault	Schlepper Obst Wein / TZ	160-94			0	0								
820093N	Renault	Schlepper Obst Wein / TZ	175-74			0	0								
820093N	Renault	Schlepper Obst Wein / TZ	180-94			0	0								
821887N	Steyr	Schlepper / CVT	6140			0	0	390	127	76					134784255
821887N	Steyr	Schlepper / CVT	6150			0	0	390	127	76					134784255
821887N	Steyr	Schlepper / CVT	6160			0	0	390	127	76					134784255
821887N	Steyr	Schlepper / CVT	6175			0	0	390	127	76					134784255
820994N	Valtra Valmet	Schlepper / 600	602			0	0	590	155	66					V32745600 V32746010
820994N	Valtra Valmet	Schlepper / 600	602T			0	0	590	155	66					V32745600 V32746010
820994N	Valtra Valmet	Schlepper / 600	604			0	0	590	155	66					V32745600 V32746010
820994N	Valtra Valmet	Schlepper / 600	604T			0	0	590	155	66					V32745600 V32746010
820994N	Valtra Valmet	Schlepper / 600	605			0	0	590	155	66					V32745600 V32746010
820994N	Valtra Valmet	Schlepper / 600	612			0	0	590	155	66					V32745600 V32746010

Dasis Nr.	Hersteller	Modell	Typ	Bj von	Bj bis	PS	ccmTech	Netzlänge [mm]	Netzbreite [mm]	Netztiefe [mm]	Ausstattungsvariante	Einlass-Ø [mm]	Auslass-Ø [mm]	Einbaudicke [mm]	für OE-Nummer
820994N	Valtra Valmet	Schlepper / 600	615			0	0	590	155	66					V32745600 V32746010
820994N	Valtra Valmet	Schlepper / 600	655			0	0	590	155	66					V32745600 V32746010
820994N	Valtra Valmet	Schlepper / 700	700			0	0	590	155	66					V32745600 V32746010
820994N	Valtra Valmet	Schlepper / 700	702			0	0	590	155	66					V32745600 V32746010
820994N	Valtra Valmet	Schlepper / 700	702S			0	0	590	155	66					V32745600 V32746010
820994N	Valtra Valmet	Schlepper / 700	703			0	0	590	155	66					V32745600 V32746010
820994N	Valtra Valmet	Schlepper / 700	705			0	0	590	155	66					V32745600 V32746010
820994N	Valtra Valmet	Schlepper / 700	715			0	0	590	155	66					V32745600 V32746010
820994N	Valtra Valmet	Schlepper / 700	755			0	0	590	155	66					V32745600 V32746010
820994N	Valtra Valmet	Schlepper / 800	800			0	0	590	155	66					V32745600 V32746010
820994N	Valtra Valmet	Schlepper / 800	802			0	0	590	155	66					V32745600 V32746010
820994N	Valtra Valmet	Schlepper / 800	803			0	0	590	155	66					V32745600 V32746010
820994N	Valtra Valmet	Schlepper / 800	805			0	0	590	155	66					V32745600 V32746010
820994N	Valtra Valmet	Schlepper / 800	815			0	0	590	155	66					V32745600 V32746010
820994N	Valtra Valmet	Schlepper / 800	855			0	0	590	155	66					V32745600 V32746010
820994N	Valtra Valmet	Schlepper / 900	900			0	0	590	155	66					V32745600 V32746010
820994N	Valtra Valmet	Schlepper / 900	903			0	0	590	155	66					V32745600 V32746010
820297N	Valtra Valmet	Schlepper / 6000	6000			0	0								
820994N	Valtra Valmet	Schlepper / 6000	6000			0	0	590	155	66					V32745600 V32746010
820297N	Valtra Valmet	Schlepper / 6000	6100			0	0								
820994N	Valtra Valmet	Schlepper / 6000	6100			0	0	590	155	66					V32745600 V32746010
820297N	Valtra Valmet	Schlepper / 6000	6200			0	0								

Dasis Nr.	Hersteller	Modell	Typ	Bj von	Bj bis	PS	ccmTech	Netzlänge [mm]	Netzbreite [mm]	Netztiefe [mm]	Ausstattungsvariante	Einlass-Ø [mm]	Auslass-Ø [mm]	Einbaudicke [mm]	für OE-Nummer
820994N	Valtra Valmet	Schlepper / 6000	6200			0	0	590	155	66					V32745600 V32746010
820297N	Valtra Valmet	Schlepper / 6000	6300			0	0								
820994N	Valtra Valmet	Schlepper / 6000	6300			0	0	590	155	66					V32745600 V32746010
820297N	Valtra Valmet	Schlepper / 6000	6400			0	0								
820994N	Valtra Valmet	Schlepper / 6000	6400			0	0	590	155	66					V32745600 V32746010
820297N	Valtra Valmet	Schlepper / 6000	6600			0	0								
820994N	Valtra Valmet	Schlepper / 6000	6600			0	0	590	155	66					V32745600 V32746010
820297N	Valtra Valmet	Schlepper / 6000	6800			0	0								
820994N	Valtra Valmet	Schlepper / 6000	6800			0	0	590	155	66					V32745600 V32746010
820297N	Valtra Valmet	Schlepper / 6000	6900			0	0								
820994N	Valtra Valmet	Schlepper / 6000	6900			0	0	590	155	66					V32745600 V32746010
820297N	Valtra Valmet	Schlepper / 8000	8000			0	0								
820994N	Valtra Valmet	Schlepper / 8000	8000			0	0	590	155	66					V32745600 V32746010
820994N	Valtra Valmet	Schlepper / 8000	8050			0	0	590	155	66					V32745600 V32746010
820297N	Valtra Valmet	Schlepper / 8000	8100			0	0								
820994N	Valtra Valmet	Schlepper / 8000	8100			0	0	590	155	66					V32745600 V32746010
820994N	Valtra Valmet	Schlepper / 8000	8150			0	0	590	155	66					V32745600 V32746010
820297N	Valtra Valmet	Schlepper / 8000	8200			0	0								
820994N	Valtra Valmet	Schlepper / 8000	8200			0	0	590	155	66					V32745600 V32746010
820297N	Valtra Valmet	Schlepper / 8000	8300			0	0								
820994N	Valtra Valmet	Schlepper / 8000	8300			0	0	590	155	66					V32745600 V32746010
820297N	Valtra Valmet	Schlepper / 8000	8300T			0	0								
820994N	Valtra Valmet	Schlepper / 8000	8300T			0	0	590	155	66					V32745600 V32746010
820297N	Valtra Valmet	Schlepper / 8000	8400			0	0								
820994N	Valtra Valmet	Schlepper / 8000	8400			0	0	590	155	66					V32745600 V32746010

Dasis Nr.	Hersteller	Modell	Typ	Bj von	Bj bis	PS	ccmTech	Netzlänge [mm]	Netzbreite [mm]	Netztiefe [mm]	Ausstattungsvariante	Einlass-Ø [mm]	Auslass-Ø [mm]	Einbaudicke [mm]	für OE-Nummer
820994N	Valtra Valmet	Schlepper / 8000	8450			0	0	590	155	66					V32745600 V32746010
820994N	Valtra Valmet	Schlepper / 8000	8550			0	0	590	155	66					V32745600 V32746010
820297N	Valtra Valmet	Schlepper / 8000	8600			0	0								
820994N	Valtra Valmet	Schlepper / 8000	8600			0	0	590	155	66					V32745600 V32746010
820994N	Valtra Valmet	Schlepper / 8000	8750			0	0	590	155	66					V32745600 V32746010
820297N	Valtra Valmet	Schlepper / 8000	8800			0	0								
820994N	Valtra Valmet	Schlepper / 8000	8800			0	0	590	155	66					V32745600 V32746010
820994N	Valtra Valmet	Schlepper / A	82			0	0	590	155	66					V32745600 V32746010
820994N	Valtra Valmet	Schlepper / A	83			0	0	590	155	66					V32745600 V32746010
820297N	Valtra Valmet	Schlepper / A	85			0	0								
820994N	Valtra Valmet	Schlepper / A	85			0	0	590	155	66					V32745600 V32746010
820994N	Valtra Valmet	Schlepper / A	92			0	0	590	155	66					V32745600 V32746010
820994N	Valtra Valmet	Schlepper / A	93			0	0	590	155	66					V32745600 V32746010
820994N	Valtra Valmet	Schlepper / A	95			0	0	590	155	66					V32745600 V32746010
820205N	Valtra Valmet	Schlepper / T1	191			0	0	1	1	1					F339552050020
820223N	Volvo	Motorgrader / C	A25C			0	0								
820223N	Volvo	Motorgrader / C	A30C			0	0								
820223N	Volvo	Motorgrader / C	A40C			0	0								
820993N	Volvo	Radlader	L20F			0	0	235	341	48	mit Rohre	16	18		15075798
820993N	Volvo	Radlader	L25F			0	0	235	341	48	mit Rohre	16	18		15075798
820993N	Volvo	Radlader	L28F			0	0	235	341	48	mit Rohre	16	18		15075798
820993N	Volvo	Radlader	L50F			0	0	235	341	48	mit Rohre	16	18		15075798
820993N	Volvo	Radlader	L60F			0	0	235	341	48	mit Rohre	16	18		15075798
820993N	Volvo	Radlader	L70F			0	0	235	341	48	mit Rohre	16	18		15075798
820993N	Volvo	Radlader	L80F			0	0	235	341	48	mit Rohre	16	18		15075798
820993N	Volvo	Radlader	L90F			0	0	235	341	48	mit Rohre	16	18		15075798

Dasis Nr.	Hersteller	Modell	Typ	Bj von	Bj bis	PS	ccmTech	Netzlänge [mm]	Netzbreite [mm]	Netztiefe [mm]	Ausstattungsvariante	Einlass-Ø [mm]	Auslass-Ø [mm]	Einbaudicke [mm]	für OE-Nummer
820993N	Volvo	Radlader	L110F			0	0	235	341	48	mit Rohre	16	18		15075798
820993N	Volvo	Radlader	L200F			0	0	235	341	48	mit Rohre	16	18		15075798
820993N	Volvo	Radlader	L350F			0	0	235	341	48	mit Rohre	16	18		15075798
820223N	Volvo	Schaufellader / D	L50D			0	0								
820223N	Volvo	Schaufellader / D	L70D			0	0								
820223N	Volvo	Schaufellader / D	L90D			0	0								
820223N	Volvo	Schaufellader / D	L120D			0	0								
820223N	Volvo	Schaufellader / D	L150D			0	0								
820223N	Volvo	Schaufellader / E	L60E			0	0								
820223N	Volvo	Schaufellader / E	L70E			0	0								
820223N	Volvo	Schaufellader / E	L90E			0	0								
820223N	Volvo	Schaufellader / E	L110E			0	0								
820223N	Volvo	Schaufellader / E	L120E			0	0								
820223N	Volvo	Schaufellader / E	L150E			0	0								
820223N	Volvo	Schaufellader / E	L180E			0	0								
820223N	Volvo	Schaufellader / E	L220E			0	0								
820223N	Volvo	Schaufellader / E	L330E			0	0								
820223N	Volvo	Schaufellader / L	50			0	0								
820223N	Volvo	Schaufellader / L	70			0	0								
820223N	Volvo	Schaufellader / L	90			0	0								
820223N	Volvo	Schaufellader / L	120			0	0								
820223N	Volvo	Schaufellader / L	170			0	0								



**750001N**

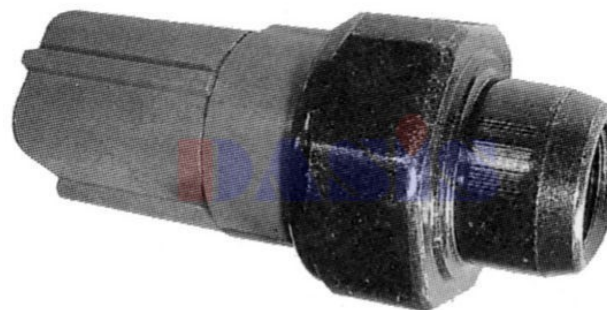

*Bilder dienen nur zu Vergleichszwecken und können geringfügig abweichen.*

**860050N**



**860092N**  
Anschlussgewinde: F,

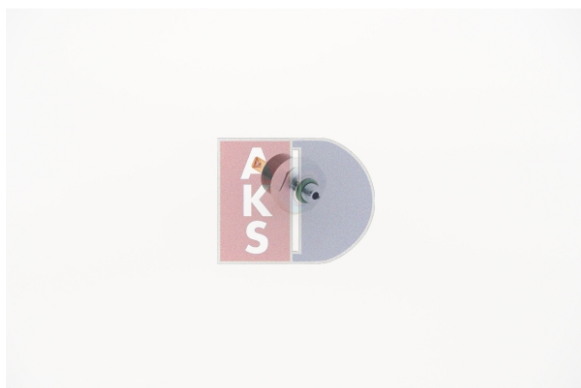

**860125N**  
Anschlussgewinde: M, Spezifikation: Trinary,



*Bilder dienen nur zu Vergleichszwecken und können geringfügig abweichen.*

**860126N**  
Anschlussgewinde: M,



**860127N**



860128N



860129N



860131N

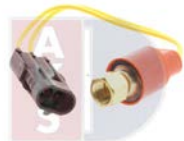

860132N



860133N  
Anschlussgewinde: F,



860136N  
Anschlussgewinde: F, Ausgangsdruck von [bar]: 12,  
Eingangsdruck von [bar]: 15, Spezifikation: Binary,





860137N



Bilder dienen nur zu Vergleichszwecken und können geringfügig abweichen.

860138N

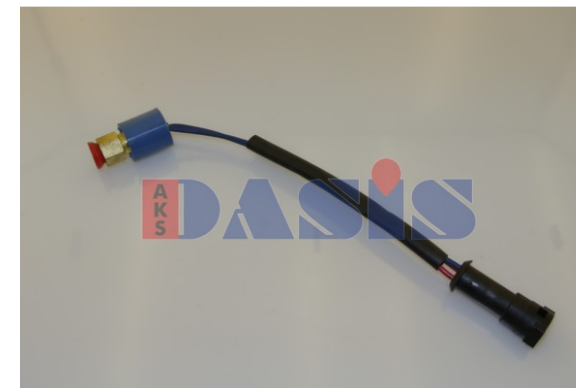

860141N



860142N



860143N

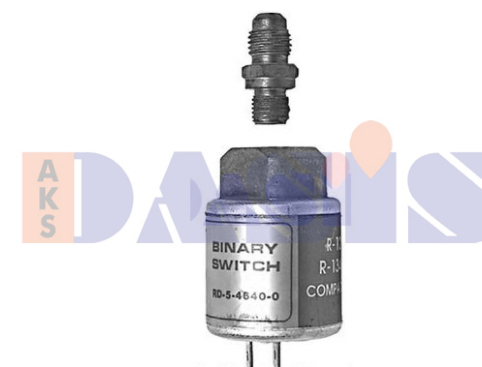

Bilder dienen nur zu Vergleichszwecken und können geringfügig abweichen.

860145N  
Anschlussgewinde: F,



860146N

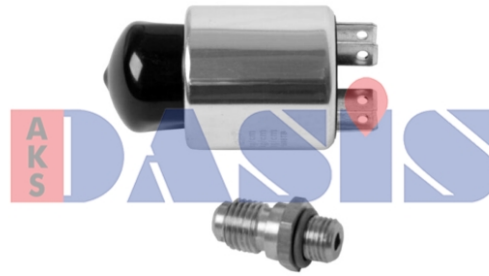

Bilder dienen nur zur Vergleichszwecken und können geringfügig abweichen.

860147N



860148N



Bilder dienen nur zu Vergleichszwecken und können geringfügig abweichen.

860149N

Ausstattungsvariante: 3 Schaltstufen,



860153N

Anschlussgewinde: M, Ausgangsdruck von [bar]: 31,  
Eingangsdruck von [bar]: 2, Spezifikation: Binary,



Bilder dienen nur zu Vergleichszwecken und können geringfügig abweichen.

860189N



Bilder dienen nur zu Vergleichszwecken und können geringfügig abweichen.

860191N

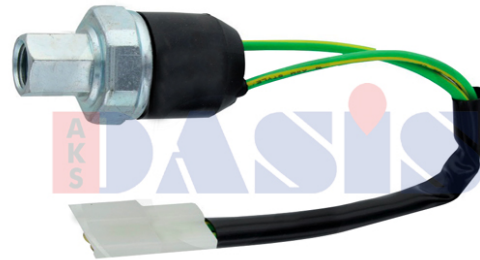

Bilder dienen nur zu Vergleichszwecken und können geringfügig abweichen.

860192N



860204N



860578N



Bilder dienen nur zu Vergleichszwecken und können geringfügig abweichen.

860617N

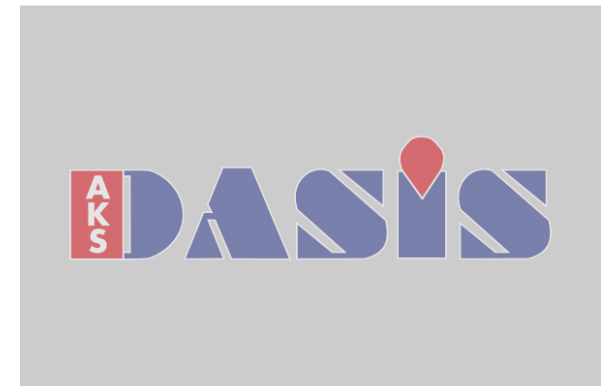

860619N  
Anschlussgewinde: F,



448177N



448178N

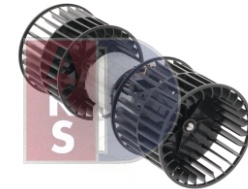

448180N



740022N



*Bilder dienen nur zu Vergleichszwecken und können geringfügig abweichen.*

740036N



*Bilder dienen nur zu Vergleichszwecken und können geringfügig abweichen.*

740043N

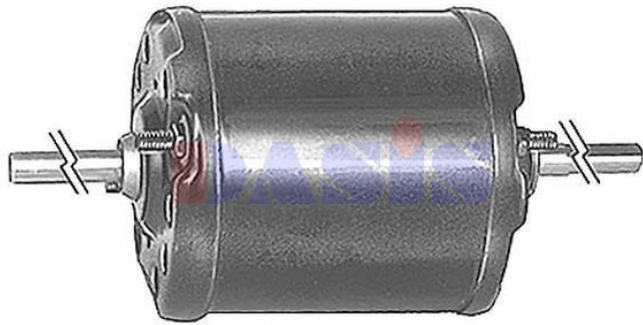

Bilder dienen nur zu Vergleichszwecken und können geringfügig abweichen.

**740045N**



Bilder dienen nur zu Vergleichszwecken und können geringfügig abweichen.

**740085N**



Bilder dienen nur zu Vergleichszwecken und können geringfügig abweichen.

**740127N**



**740170N**



Bilder dienen nur zu Vergleichszwecken und können geringfügig abweichen.

**740201N**



Bilder dienen nur zu Vergleichszwecken und können geringfügig abweichen.

**740813N**



Bilder dienen nur zu Vergleichszwecken und können geringfügig abweichen.

**740816N**

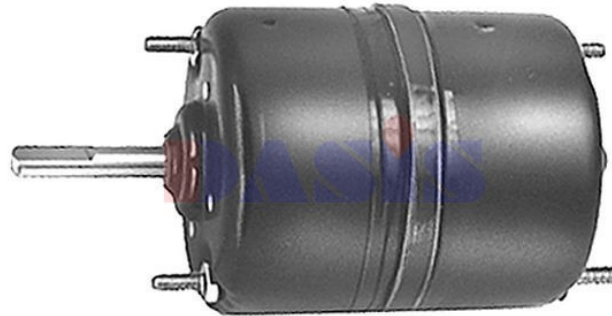

Bilder dienen nur zu Vergleichszwecken und können geringfügig abweichen.

**740831N**



Bilder dienen nur zu Vergleichszwecken und können geringfügig abweichen.

**740832N**

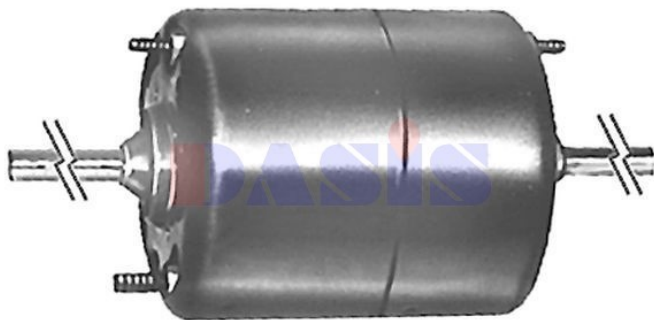

Bilder dienen nur zu Vergleichszwecken und können geringfügig abweichen.

**740834N**



Bilder dienen nur zur Vergleichszwecken und können geringfügig abweichen.

**741951N**



Bilder dienen nur zur Vergleichszwecken und können geringfügig abweichen.

**741960N**



**840006N**

**Außengewindemaß Druckseite: 15 mm, Außengewindemaß Saugseite: 19 mm, Kapillarrohrlänge [mm]: 230, Spezifikation: O-Ring,**



**840019N**



**840037N**

**Innengewindemaß Druckseite: 3/8 / 5/8, Innengewindemaß Saugseite: 5/8 / 5/8, Spezifikation: O-Ring,**



**840039N**

**Spezifikation: Flansch,**



**840048N**

**Spezifikation: Flansch,**



**840050N**

**Außengewindemaß Druckseite: 13, Außengewindemaß Saugseite: 16, Kapillarrohrlänge [mm]: 480, Spezifikation: Konus,**



**840084N**

**Außengewindemaß Druckseite: 16, Außengewindemaß Saugseite: 18, Kapillarrohrlänge [mm]: 305,**



**840086N**

**Spezifikation: Innengewinde,**



**840091N**

**Außengewindemaß Druckseite: 16, Außengewindemaß Saugseite: 18, Kapillarrohrlänge [mm]: 300, Spezifikation: O-Ring,**



**840100N**

**Außengewindemaß Druckseite: 3/8, Außengewindemaß Saugseite: 1/2, Kapillarrohrlänge [mm]: 419, Spezifikation: O-Ring,**



**840120N**

**Spezifikation: O-Ring,**



**840123N**

*Bilder dienen nur zu Vergleichszwecken und können geringfügig abweichen.*





Bilder dienen nur zu Vergleichszwecken und können geringfügig abweichen.

**840129N**



**840130N**  
Spezifikation: O-Ring,



**840154N**



**840156N**



**840157N**  
Spezifikation: O-Ring,



Bilder dienen nur zu Vergleichszwecken und können geringfügig abweichen.

**840160N**  
Kapillarrohrlänge [mm]: 710,



**840161N**  
Kapillarrohrlänge [mm]: 305,



**840162N**



**840163N**  
Innengewindemaß Druckseite: 3/8 / 1/2, Innengewindemaß  
Saugseite: 5/8 / 3/4, Spezifikation: O-Ring,



**840166N**  
Spezifikation: O-Ring,



**840280N**



**840290N**  
Spezifikation: Innengewinde,



Bilder dienen nur zur Vergleichszwecken und können geringfügig abweichen.

840303N



840310N

Innengewindemaß Druckseite: 3/8 / 1/2, Innengewindemaß Saugseite: 5/8 / 3/4, Spezifikation: O-Ring,



840340N

Außengewindemaß Druckseite: 15, Außengewindemaß Saugseite: 18, Kapillarrohrlänge [mm]: 305, Spezifikation: Konus,



Bilder dienen nur zur Vergleichszwecken und können geringfügig abweichen.

840353N



Bilder dienen nur zur Vergleichszwecken und können geringfügig abweichen.

840360N

Kapillarrohrlänge [mm]: 840, Spezifikation: Flansch,



840370N

Außengewindemaß Druckseite: 16, Außengewindemaß Saugseite: 18,



**840380N**



**840490N**

**Außengewindemaß Druckseite: 16, Außengewindemaß Saugseite: 18, Kapillarrohrlänge [mm]: 355, Spezifikation: O-Ring,**



**840520N**

**Innengewindemaß Druckseite: 3/8 / 1/2, Innengewindemaß Saugseite: 5/8 / 3/4, Spezifikation: O-Ring,**



**840660N**

**Spezifikation: O-Ring,**



**840670N**

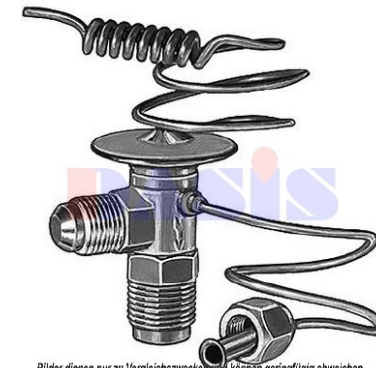

Bilder dienen nur zu Vergleichszwecken und können geringfügig abweichen.

**841041N**

**Kapillarrohrlänge [mm]: 305, Spezifikation: Flansch,**



**841042N**

**Außengewindemaß Druckseite: 15, Außengewindemaß  
Saugseite: 19, Kapillarrohrlänge [mm]: 838, Spezifikation: O-  
Ring\_BULB,**

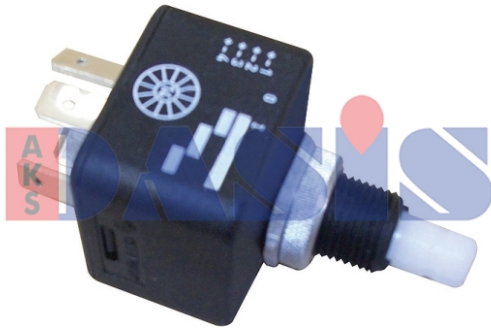

Bilder dienen nur zur Vergleichszwecken und können geringfügig abweichen.

746342N

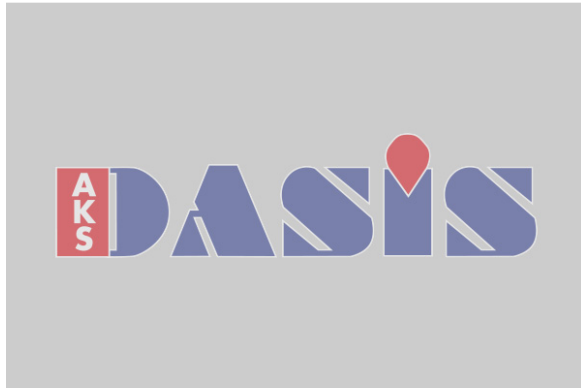

448168N



448172N



*Bilder dienen nur zu Vergleichszwecken und können geringfügig abweichen.*

448173N



*Bilder dienen nur zu Vergleichszwecken und können geringfügig abweichen.*

448174N

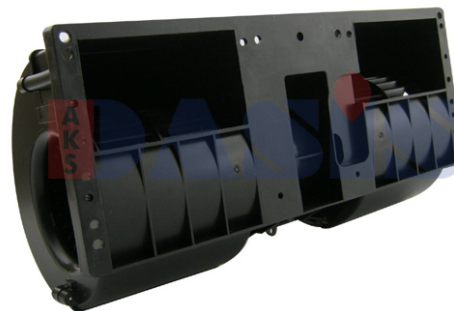

*Bilder dienen nur zu Vergleichszwecken und können geringfügig abweichen.*

448175N



*Bilder dienen nur zu Vergleichszwecken und können geringfügig abweichen.*

448176N



Bilder dienen nur zur Vergleichszwecken und können geringfügig abweichen.

**448194N**

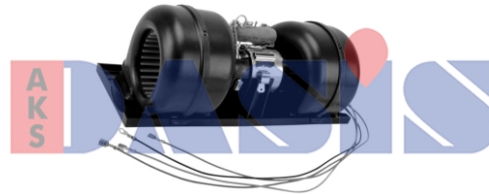

Bilder dienen nur zur Vergleichszwecken und können geringfügig abweichen.

**448195N**



**448205N**  
Spannung [V]: 12,



**740817N**

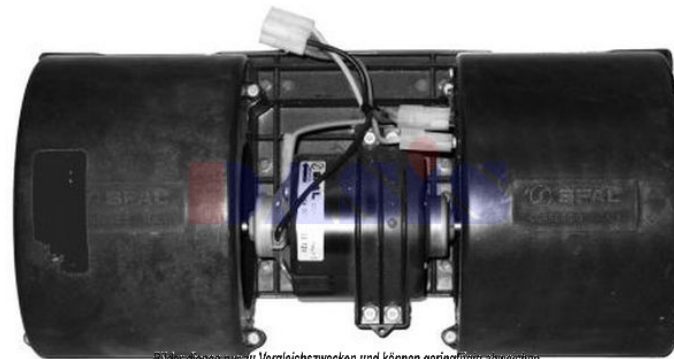

Bilder dienen nur zur Vergleichszwecken und können geringfügig abweichen.

**740818N**  
Spannung [V]: 12,



**740819N**  
Spannung [V]: 12,





*Bilder dienen nur zu Vergleichszwecken und können geringfügig abweichen.*

**740821N**



**740822N**  
Spannung [V]: 24,



*Bilder dienen nur zu Vergleichszwecken und können geringfügig abweichen.*

**740823N**

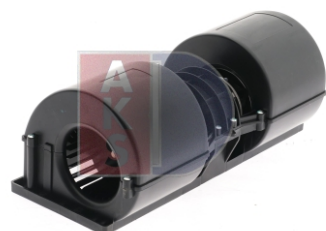

**740824N**  
Spannung [V]: 12,



**740825N**  
Spannung [V]: 12,



**740826N**



**740827N**  
Spannung [V]: 12,



**740829N**



Bilder dienen nur zur Vergleichszwecken und können geringfügig abweichen.

**741952N**  
Spannung [V]: 24,

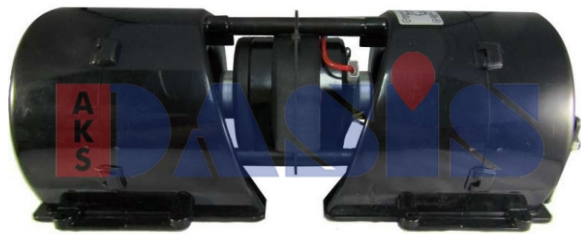

Bilder dienen nur zur Vergleichszwecken und können geringfügig abweichen.

**741953N**

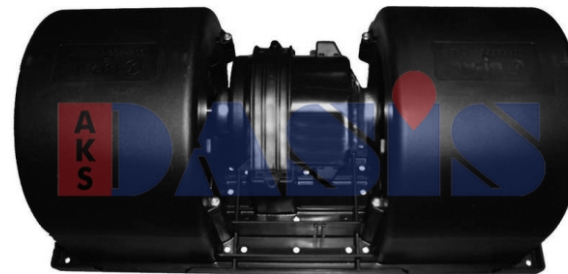

Bilder dienen nur zur Vergleichszwecken und können geringfügig abweichen.

**741954N**  
Spannung [V]: 24,

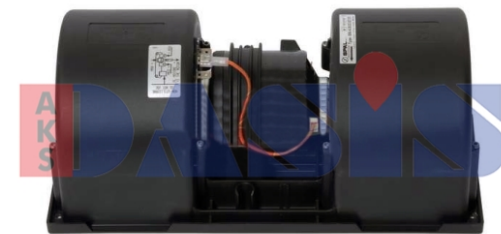

Bilder dienen nur zur Vergleichszwecken und können geringfügig abweichen.

**741955N**

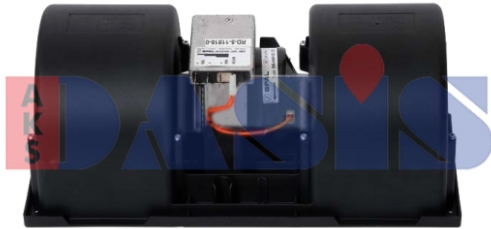

Bilder dienen nur zur Vergleichszwecken und können geringfügig abweichen.

**741956N**



Bilder dienen nur zur Vergleichszwecken und können geringfügig abweichen.

**741957N**  
Spannung [V]: 12,



Bilder dienen nur zur Vergleichszwecken und können geringfügig abweichen.

**741958N**  
Spannung [V]: 12,



Bilder dienen nur zur Vergleichszwecken und können geringfügig abweichen.

**741959N**



Bilder dienen nur zur Vergleichszwecken und können geringfügig abweichen.

**741961N**



**850327N**

Riemenscheiben-Ø [mm]: 115, Rippenanzahl: 2, Spannung [V]: 12,



**850340N**

Riemenscheiben-Ø [mm]: 125, Rippenanzahl: 8, Spannung [V]: 12,



**850352N**



**850408N**



*Bilder dienen nur zu Vergleichszwecken und können geringfügig abweichen.*

**850409N**

Riemenscheiben-Ø [mm]: 139, Rippenanzahl: 1, Spannung [V]: 12,



**850414N**

Riemenscheiben-Ø [mm]: 132, Rippenanzahl: 2, Spannung [V]: 12, Zylinderkopf-ID (Kompressor): M,



**850421N**  
Spannung [V]: 12,



**850422N**  
Riemenscheiben- $\emptyset$  [mm]: ohne Riemenscheibe,  
Rippenanzahl: ohne Riemenscheibe,



**850423N**



**850426N**  
Riemenscheiben- $\emptyset$  [mm]: 136, Rippenanzahl: 1, Spannung  
[V]: 12,



**850456N**  
Riemenscheiben- $\emptyset$  [mm]: 132, Rippenanzahl: 2, Spannung  
[V]: 12,



**850457N**  
Riemenscheiben- $\emptyset$  [mm]: 152, Rippenanzahl: 2, Spannung  
[V]: 12, Zylinderkopf-ID (Kompressor): Q,



**850497N**

Riemenscheiben-Ø [mm]: 135, Rippenanzahl: 2, Spannung [V]: 12,



**850516N**

Riemenscheiben-Ø [mm]: 146, Rippenanzahl: 1, Spannung [V]: 12,



**850552N**

Riemenscheiben-Ø [mm]: 132, Rippenanzahl: 8, Spannung [V]: 24,



*Bilder dienen nur zu Vergleichszwecken und können geringfügig abweichen.*

**850574N**

Riemenscheiben-Ø [mm]: 135, Rippenanzahl: 6, Spannung [V]: 12,



**850625N**

Riemenscheiben-Ø [mm]: 132, Rippenanzahl: 2, Spannung [V]: 12, Zylinderkopf-ID (Kompressor): QC,



**850626N**

Riemenscheiben-Ø [mm]: 120, Rippenanzahl: 10, Spannung [V]: 24, Zylinderkopf-ID (Kompressor): VE,



**850670N**

Riemenscheiben-Ø [mm]: 132, Rippenanzahl: 8, Spannung [V]: 24, Zylinderkopf-ID (Kompressor): WV,



**850685N**

*Bilder dienen nur zu Vergleichszwecken und können geringfügig abweichen.*



**850698N**

Riemenscheiben-Ø [mm]: 120, Rippenanzahl: 6, Spannung [V]: 12,



**850700N**

Riemenscheiben-Ø [mm]: 140, Rippenanzahl: 1, Spannung [V]: 12,



**850713N**

Riemenscheiben-Ø [mm]: 130, Rippenanzahl: 2,



**850851N**

Riemenscheiben-Ø [mm]: 125, Rippenanzahl: 2, Spannung [V]: 24,



**850856N**



**850863N**

Riemenscheiben-Ø [mm]: 135, Rippenzahl: 2, Spannung [V]: 12,



**850870N**

Riemenscheiben-Ø [mm]: 132, Rippenzahl: 2, Spannung [V]: 12, Zylinderkopf-ID (Kompressor): FG,



**850873N**

Riemenscheiben-Ø [mm]: 132, Rippenzahl: 2, Spannung [V]: 12, Zylinderkopf-ID (Kompressor): M,



**850874N**

Riemenscheiben-Ø [mm]: 152, Rippenzahl: 2, Spannung [V]: 12, Zylinderkopf-ID (Kompressor): MD,



**850875N**

Riemenscheiben-Ø [mm]: 132, Rippenzahl: 2, Spannung [V]: 12, Zylinderkopf-ID (Kompressor): KG,





**850876N**

Riemenscheiben-Ø [mm]: 152, Rippenanzahl: 2, Spannung [V]: 12,



**850878N**

Riemenscheiben-Ø [mm]: 138, Rippenanzahl: 1, Spannung [V]: 12, Zylinderkopf-ID (Kompressor): KC,



**850879N**

Riemenscheiben-Ø [mm]: 132, Rippenanzahl: 2, Spannung [V]: 12, Zylinderkopf-ID (Kompressor): K,



**850882N**

Riemenscheiben-Ø [mm]: 132, Rippenanzahl: 2, Spannung [V]: 12,



**850883N**

Riemenscheiben-Ø [mm]: 140, Rippenanzahl: 2, Spannung [V]: 12, Zylinderkopf-ID (Kompressor): QC,



**850884N**

Riemenscheiben-Ø [mm]: 132, Rippenanzahl: 2, Spannung [V]: 12, Zylinderkopf-ID (Kompressor): N,



**850885N**

Riemenscheiben-Ø [mm]: 132, Rippenanzahl: 2, Spannung [V]: 12, Zylinderkopf-ID (Kompressor): FL,



**850886N**

Riemenscheiben-Ø [mm]: 125, Rippenanzahl: 6, Spannung [V]: 12, Zylinderkopf-ID (Kompressor): UB,



**850887N**

Riemenscheiben-Ø [mm]: 119, Rippenanzahl: 6, Spannung [V]: 12, Zylinderkopf-ID (Kompressor): GV,



**850888N**

*Bilder dienen nur zu Vergleichszwecken und können geringfügig abweichen.*



**850889N**

Riemenscheiben-Ø [mm]: 133, Rippenanzahl: 8, Spannung [V]: 12, Zylinderkopf-ID (Kompressor): KC,



**850891N**

Riemenscheiben-Ø [mm]: 158, Rippenanzahl: 2, Spannung [V]: 12,



**850892N**

Riemenscheiben-Ø [mm]: 132, Rippenanzahl: 2, Spannung [V]: 12, Zylinderkopf-ID (Kompressor): MJ,



**850893N**

Riemenscheiben-Ø [mm]: 152, Rippenanzahl: 2, Spannung [V]: 12, Zylinderkopf-ID (Kompressor): B,



**850895N**

Riemenscheiben-Ø [mm]: 125, Rippenanzahl: 6, Spannung [V]: 12,



**850896N**

Riemenscheiben-Ø [mm]: 125, Rippenanzahl: 2, Spannung [V]: 12,



**850897N**

Riemenscheiben-Ø [mm]: 138, Rippenanzahl: 1, Spannung [V]: 12, Zylinderkopf-ID (Kompressor): GK,



**850945N**

Riemenscheiben-Ø [mm]: 132, Rippenanzahl: 6,



**850956N**

Riemenscheiben-Ø [mm]: 125, Rippenanzahl: 8, Spannung [V]: 12,



*Bilder dienen nur zu Vergleichszwecken und können geringfügig abweichen.*

**851097N**

Riemenscheiben-Ø [mm]: 172, Rippenanzahl: 1, Spannung [V]: 12,



*Bilder dienen nur zu Vergleichszwecken und können geringfügig abweichen.*

**851098N**

Riemenscheiben-Ø [mm]: 132, Rippenanzahl: 1, Spannung [V]: 12,



**851099N**

Riemenscheiben-Ø [mm]: 146, Rippenanzahl: 8, Spannung [V]: 12,



*Bilder dienen nur zu Vergleichszwecken und können geringfügig abweichen.*

**851104N**

Riemenscheiben-Ø [mm]: 133, Rippenanzahl: 1, Spannung [V]: 12,



**851105N**

Riemenscheiben-Ø [mm]: 132, Rippenanzahl: 2, Spannung [V]: 12, Zylinderkopf-ID (Kompressor): B,



**851107N**

Riemenscheiben- $\emptyset$  [mm]: 132, Rippenanzahl: 2, Spannung [V]: 12,



**851109N**

Riemenscheiben- $\emptyset$  [mm]: 132, Rippenanzahl: 2, Spannung [V]: 12, Zylinderkopf-ID (Kompressor): N,



**851111N**

Riemenscheiben- $\emptyset$  [mm]: 132, Rippenanzahl: 2, Spannung [V]: 12,



**851406N**

Riemenscheiben- $\emptyset$  [mm]: 132, Rippenanzahl: 2, Spannung [V]: 12,



**851408N**

Riemenscheiben- $\emptyset$  [mm]: 132, Rippenanzahl: 2, Spannung [V]: 12,

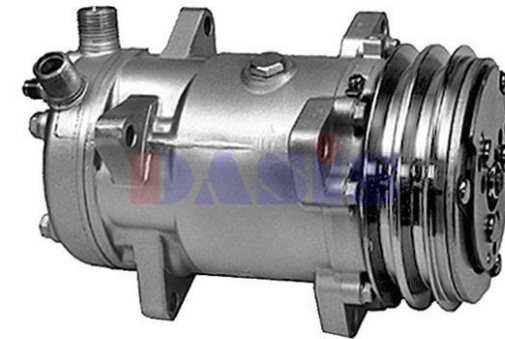

**851608N**

Rippenanzahl: 2, Spannung [V]: 24,

*Bilder dienen nur zu Vergleichszwecken und können geringfügig abweichen.*

*Bilder dienen nur zu Vergleichszwecken und können geringfügig abweichen.*



*Bilder dienen nur zu Vergleichszwecken und können geringfügig abweichen.*

**851698N**

Riemenscheiben-Ø [mm]: 132, Rippenanzahl: 2, Spannung [V]: 12,



**851699N**

Riemenscheiben-Ø [mm]: 132, Rippenanzahl: 2, Spannung [V]: 12, Zylinderkopf-ID (Kompressor): CB,



**851702N**

Riemenscheiben-Ø [mm]: 132, Rippenanzahl: 2, Spannung [V]: 12,



**851703N**

Riemenscheiben-Ø [mm]: 135, Rippenanzahl: 2, Spannung [V]: 12,



**851704N**

Riemenscheiben-Ø [mm]: 132, Rippenanzahl: 2, Spannung [V]: 12,



*Bilder dienen nur zu Vergleichszwecken und können geringfügig abweichen.*

**851705N**

Riemenscheiben-Ø [mm]: 125, Rippenanzahl: 2, Spannung [V]: 12,



**851707N**

Riemenscheiben-Ø [mm]: 119, Rippenanzahl: 8, Spannung [V]: 12, Zylinderkopf-ID (Kompressor): GH,



**851708N**

Riemenscheiben-Ø [mm]: 135, Rippenanzahl: 2, Spannung [V]: 24,



**851709N**

Riemenscheiben-Ø [mm]: 119, Rippenanzahl: 8, Spannung [V]: 12,



**851711N**

Riemenscheiben-Ø [mm]: 119, Rippenanzahl: 8, Spannung [V]: 12, Zylinderkopf-ID (Kompressor): JE,



**851712N**

Riemenscheiben-Ø [mm]: 132, Rippenanzahl: 2, Spannung [V]: 12,



**851713N**

Riemenscheiben-Ø [mm]: 120, Rippenanzahl: 6, Spannung [V]: 12,



**851714N**

Riemenscheiben-Ø [mm]: 121, Rippenanzahl: 2, Spannung [V]: 12,



**851716N**

Riemenscheiben-Ø [mm]: 119, Rippenanzahl: 8, Spannung [V]: 12,



**851717N**

Riemenscheiben-Ø [mm]: 135, Rippenanzahl: 2, Spannung [V]: 12, Zylinderkopf-ID (Kompressor): GV,



**851718N**

Riemenscheiben-Ø [mm]: 132, Rippenanzahl: 2, Spannung [V]: 24, Zylinderkopf-ID (Kompressor): JD,



**851719N**

Riemenscheiben-Ø [mm]: 150, Rippenanzahl: 2, Spannung [V]: 12, Zylinderkopf-ID (Kompressor): KG,



**851721N**

Riemenscheiben-Ø [mm]: 133, Rippenanzahl: 8, Spannung [V]: 24,





**851722N**

Riemenscheiben-Ø [mm]: 152, Rippenanzahl: 8, Spannung [V]: 12, Zylinderkopf-ID (Kompressor): MD,



**851723N**

Riemenscheiben-Ø [mm]: 135, Rippenanzahl: 2, Spannung [V]: 24, Zylinderkopf-ID (Kompressor): GV,



*Bilder dienen nur zu Vergleichszwecken und können geringfügig abweichen.*

**851724N**



*Bilder dienen nur zu Vergleichszwecken und können geringfügig abweichen.*

**851725N**

Riemenscheiben-Ø [mm]: 133, Rippenanzahl: 8, Spannung [V]: 24,

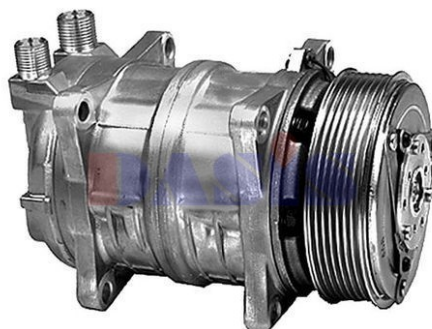

*Bilder dienen nur zu Vergleichszwecken und können geringfügig abweichen.*

**851726N**

Riemenscheiben-Ø [mm]: 120, Rippenanzahl: 8, Spannung [V]: 12,



**851727N**

Riemenscheiben-Ø [mm]: 132, Rippenanzahl: 2, Spannung [V]: 24, Zylinderkopf-ID (Kompressor): B,

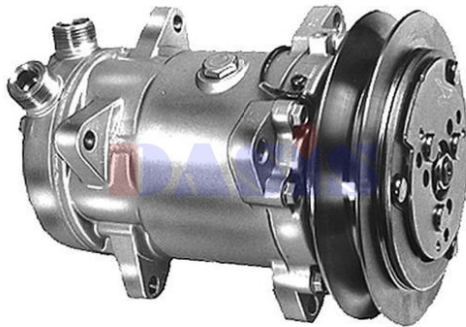

*Bilder dienen nur zu Vergleichszwecken und können geringfügig abweichen.*

**851728N**

**Riemenscheiben-Ø [mm]: 159, Rippenanzahl: 1, Spannung [V]: 12,**



**851729N**

**Riemenscheiben-Ø [mm]: 132, Rippenanzahl: 8, Spannung [V]: 12, Zylinderkopf-ID (Kompressor): KCA,**



**851731N**

**Riemenscheiben-Ø [mm]: 152, Rippenanzahl: 8, Spannung [V]: 24,**



*Bilder dienen nur zu Vergleichszwecken und können geringfügig abweichen.*

**851732N**

**Riemenscheiben-Ø [mm]: 125, Rippenanzahl: 2, Spannung [V]: 12,**



**851733N**

**Riemenscheiben-Ø [mm]: 140, Rippenanzahl: 2, Spannung [V]: 12, Zylinderkopf-ID (Kompressor): GV,**

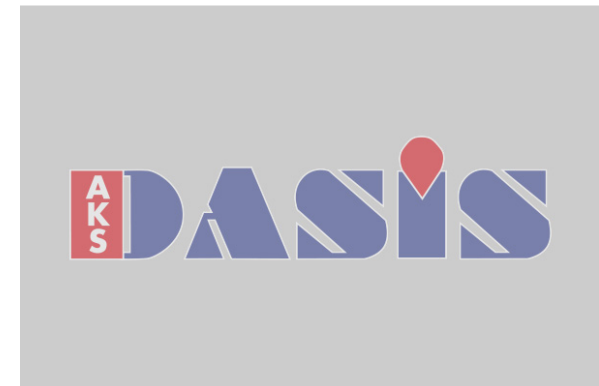

**851736N**

**Riemenscheiben-Ø [mm]: 138, Rippenanzahl: 1, Spannung [V]: 24, Zylinderkopf-ID (Kompressor): GK,**



**851738N**

Riemenscheiben- $\emptyset$  [mm]: 132, Rippenanzahl: 2, Spannung [V]: 12, Zylinderkopf-ID (Kompressor): JD,



*Bilder dienen nur zu Vergleichszwecken und können geringfügig abweichen.*

**851739N**

Riemenscheiben- $\emptyset$  [mm]: 125, Rippenanzahl: 8, Spannung [V]: 12,



**851741N**

Riemenscheiben- $\emptyset$  [mm]: 135, Rippenanzahl: 1, Spannung [V]: 12,



**851742N**

Riemenscheiben- $\emptyset$  [mm]: 132, Rippenanzahl: 2, Spannung [V]: 12,



*Bilder dienen nur zu Vergleichszwecken und können geringfügig abweichen.*

**851743N**

Riemenscheiben- $\emptyset$  [mm]: 165, Rippenanzahl: 1, Spannung [V]: 24,

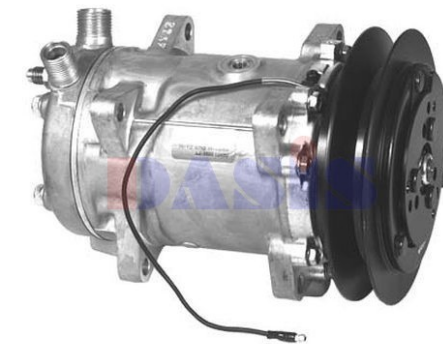

*Bilder dienen nur zu Vergleichszwecken und können geringfügig abweichen.*

**851744N**



**851745N**

Riemenscheiben-Ø [mm]: 133, Rippenanzahl: 1, Spannung [V]: 12,



**851746N**

Riemenscheiben-Ø [mm]: 152, Rippenanzahl: 2, Spannung [V]: 12, Zylinderkopf-ID (Kompressor): M,



*Bilder dienen nur zu Vergleichszwecken und können geringfügig abweichen.*

**851747N**

Riemenscheiben-Ø [mm]: 135, Rippenanzahl: 2, Spannung [V]: 24,



**851748N**

Riemenscheiben-Ø [mm]: 125, Rippenanzahl: 2, Spannung [V]: 12, Zylinderkopf-ID (Kompressor): SJA,



**851749N**

Riemenscheiben-Ø [mm]: 152, Rippenanzahl: 8, Spannung [V]: 24, Zylinderkopf-ID (Kompressor): MD,



*Bilder dienen nur zu Vergleichszwecken und können geringfügig abweichen.*

**851752N**

Riemenscheiben-Ø [mm]: 160, Rippenanzahl: 1, Spannung [V]: 24,



**851753N**

Riemenscheiben-Ø [mm]: 139, Rippenanzahl: 1, Spannung [V]: 12,



**851754N**

Riemenscheiben-Ø [mm]: 146, Rippenanzahl: 8, Spannung [V]: 24,



**851755N**

Riemenscheiben-Ø [mm]: 146, Rippenanzahl: 1, Spannung [V]: 12,



**851756N**

Riemenscheiben-Ø [mm]: 133, Rippenanzahl: 8, Spannung [V]: 12, Zylinderkopf-ID (Kompressor): JD,



*Bilder dienen nur zu Vergleichszwecken und können geringfügig abweichen.*

**851759N**

Riemenscheiben-Ø [mm]: 146, Rippenanzahl: 1, Spannung [V]: 24,



**851760N**

Riemenscheiben-Ø [mm]: 135, Rippenanzahl: 1, Spannung [V]: 24,



*Bilder dienen nur zu Vergleichszwecken und können geringfügig abweichen.*

**851761N**

**Riemenscheiben-Ø [mm]: 146, Rippenanzahl: 1, Spannung [V]: 12,**



**851762N**

**Riemenscheiben-Ø [mm]: 132, Rippenanzahl: 1, Spannung [V]: 12,**



**851763N**

**Riemenscheiben-Ø [mm]: 112, Rippenanzahl: 4, Spannung [V]: 12,**



*Bilder dienen nur zu Vergleichszwecken und können geringfügig abweichen.*

**851764N**

**Riemenscheiben-Ø [mm]: 119, Rippenanzahl: 8, Spannung [V]: 24,**



**851765N**

**Riemenscheiben-Ø [mm]: 145, Rippenanzahl: 4, Spannung [V]: 12,**



**851766N**

**Riemenscheiben-Ø [mm]: 152, Rippenanzahl: 1, Spannung [V]: 24,**



*Bilder dienen nur zu Vergleichszwecken und können geringfügig abweichen.*

**851768N**

**Riemenscheiben-Ø [mm]: 119, Rippenanzahl: 8, Spannung [V]: 12,**

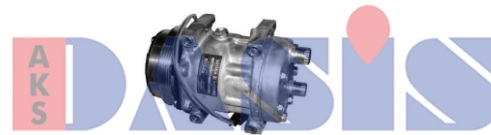

*Bilder dienen nur zur Vergleichszwecken und können geringfügig abweichen.*

**851769N**

**Riemenscheiben-Ø [mm]: 119, Rippenanzahl: 4, Spannung [V]: 12,**



**851772N**

**Riemenscheiben-Ø [mm]: 120, Rippenanzahl: 4, Spannung [V]: 12,**

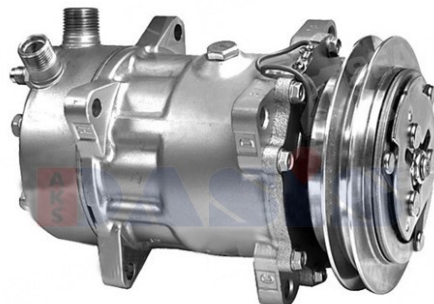

*Bilder dienen nur zu Vergleichszwecken und können geringfügig abweichen.*

**851773N**

**Riemenscheiben-Ø [mm]: 132, Rippenanzahl: 2, Spannung [V]: 24,**



**851774N**

**Riemenscheiben-Ø [mm]: 133, Rippenanzahl: 8, Spannung [V]: 12,**



*Bilder dienen nur zu Vergleichszwecken und können geringfügig abweichen.*

**851775N**

**Riemenscheiben-Ø [mm]: 115, Rippenanzahl: 1, Spannung [V]: 24,**



**851776N**  
Riemenscheiben-Ø [mm]: 152, Rippenanzahl: 1, Spannung [V]: 24,



**851777N**  
Riemenscheiben-Ø [mm]: 146, Rippenanzahl: 1, Spannung [V]: 24,



*Bilder dienen nur zu Vergleichszwecken und können geringfügig abweichen.*  
**851778N**  
Riemenscheiben-Ø [mm]: 131, Rippenanzahl: 1, Spannung [V]: 24,

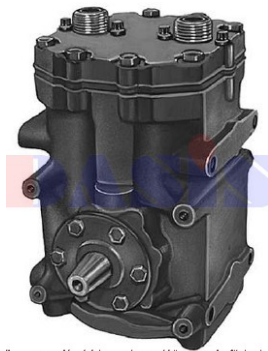

*Bilder dienen nur zu Vergleichszwecken und können geringfügig abw*  
**851779N**



*Bilder dienen nur zu Vergleichszwecken und können geringfügig abweichen.*  
**851781N**  
Riemenscheiben-Ø [mm]: 138, Rippenanzahl: 1, Spannung [V]: 24,



**851782N**  
Riemenscheiben-Ø [mm]: 139, Rippenanzahl: 1, Spannung [V]: 24,





*Bilder dienen nur zu Vergleichszwecken und können geringfügig abweichen.*

**851783N**

Riemenscheiben-Ø [mm]: 139, Rippenzahl: 1, Spannung [V]: 24,



**851784N**

Riemenscheiben-Ø [mm]: 120, Rippenzahl: 8, Spannung [V]: 12,



**851785N**

Riemenscheiben-Ø [mm]: 120, Rippenzahl: 8, Spannung [V]: 12, Zylinderkopf-ID (Kompressor): JD,



**851786N**

Riemenscheiben-Ø [mm]: 112, Rippenzahl: 4, Spannung [V]: 12, Zylinderkopf-ID (Kompressor): WV,

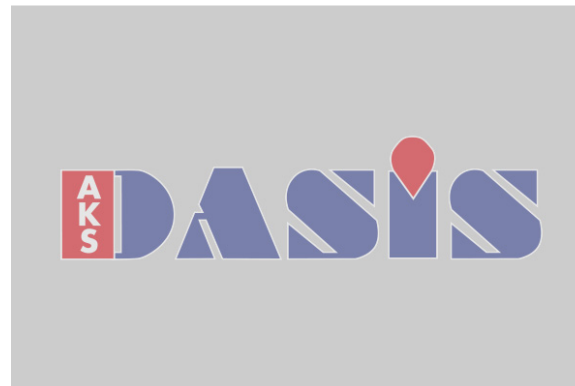

**851787N**



*Bilder dienen nur zu Vergleichszwecken und können geringfügig abweichen.*

**851790N**

Riemenscheiben-Ø [mm]: 170, Rippenzahl: 1, Spannung [V]: 24,



**852070N**

Riemenscheiben-Ø [mm]: 129, Rippenanzahl: 9, Spannung [V]: 24,



**852088N**

Riemenscheiben-Ø [mm]: 145, Rippenanzahl: 8, Spannung [V]: 24, Zylinderkopf-ID (Kompressor): JD,



**852159N**

Riemenscheiben-Ø [mm]: 125, Rippenanzahl: 2, Spannung [V]: 12, Zylinderkopf-ID (Kompressor): OB,



**852647N**

Riemenscheiben-Ø [mm]: 115, Rippenanzahl: 4, Spannung [V]: 12,



**852648N**

Riemenscheiben-Ø [mm]: 124, Rippenanzahl: 6, Spannung [V]: 12,



**852649N**

Riemenscheiben-Ø [mm]: 130, Rippenanzahl: 9, Spannung [V]: 12,

*Bilder dienen nur zu Vergleichszwecken und können geringfügig abweichen.*



**852742N**

Riemenscheiben-Ø [mm]: 140, Rippenanzahl: 1,



**852841N**

Riemenscheiben-Ø [mm]: 133, Rippenanzahl: 8, Spannung [V]: 24,

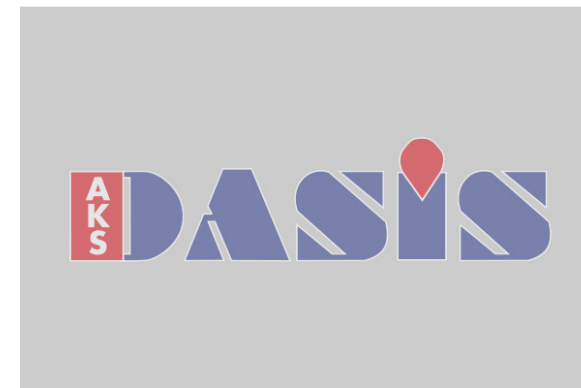

**852842N**

Riemenscheiben-Ø [mm]: 132, Spannung [V]: 24,

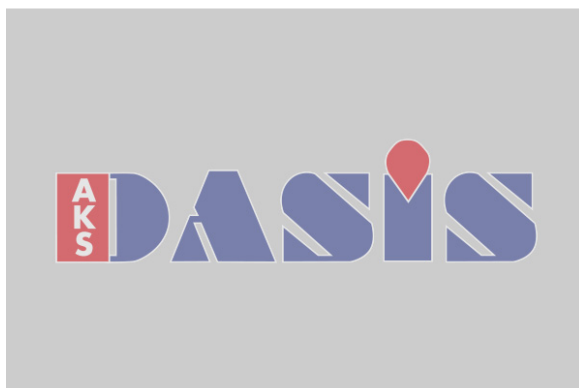

**852843N**

Riemenscheiben-Ø [mm]: 125, Rippenanzahl: 1, Spannung [V]: 12,



**852874N**

Riemenscheiben-Ø [mm]: 135, Rippenanzahl: 2, Spannung [V]: 12,

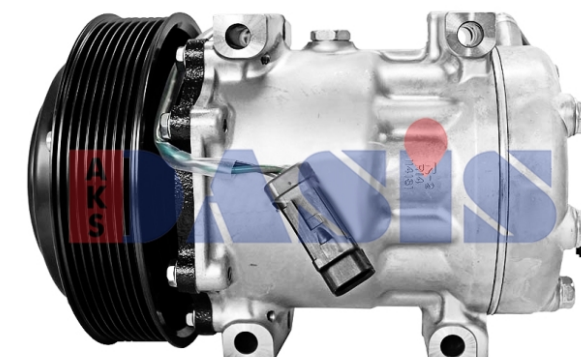

Bilder dienen nur zur Vergleichszwecken und können geringfügig abweichen.

**852890N**

Riemenscheiben-Ø [mm]: 152, Rippenanzahl: 8, Spannung [V]: 24, Zylinderkopf-ID (Kompressor): WR,



**852915N**  
 Riemenscheiben-Ø [mm]: 126, Rippenanzahl: 12, Spannung [V]: 24, Zylinderkopf-ID (Kompressor): WR,



**852916N**  
 Riemenscheiben-Ø [mm]: 133, Rippenanzahl: 1, Spannung [V]: 12,



**852917N**  
 Riemenscheiben-Ø [mm]: 119, Rippenanzahl: 8, Spannung [V]: 12,

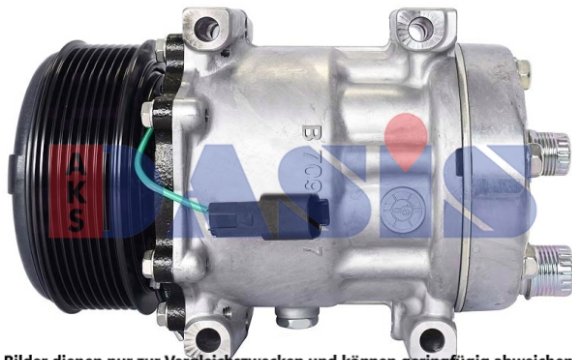

Bilder dienen nur zur Vergleichszwecken und können geringfügig abweichen.

**852921N**  
 Riemenscheiben-Ø [mm]: 119, Rippenanzahl: 8, Spannung [V]: 24, Zylinderkopf-ID (Kompressor): KG,

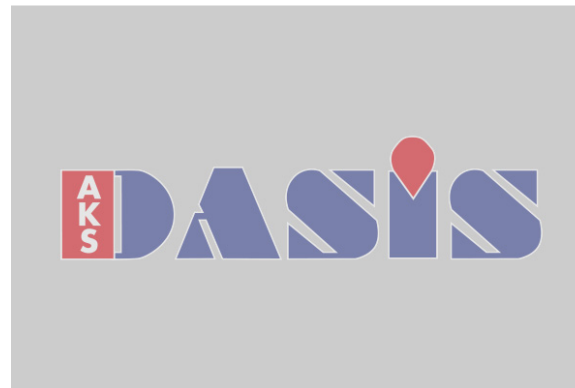

**852922N**  
 Riemenscheiben-Ø [mm]: 152, Rippenanzahl: 6, Spannung [V]: 12, Zylinderkopf-ID (Kompressor): FL,



**852923N**  
 Riemenscheiben-Ø [mm]: 133, Rippenanzahl: 6, Spannung [V]: 12,

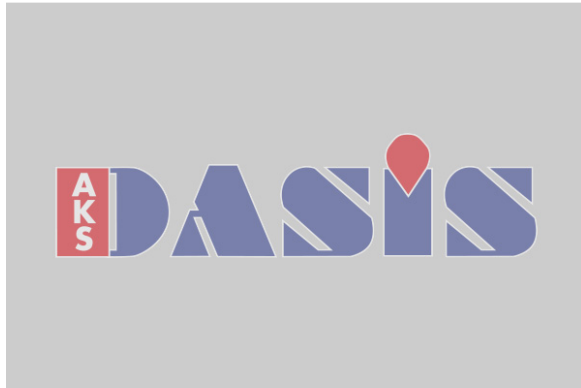

**852924N**

Riemenscheiben-Ø [mm]: 152, Rippenanzahl: 8, Spannung [V]: 12,



**852925N**

Riemenscheiben-Ø [mm]: 156, Rippenanzahl: 6, Spannung [V]: 12,



Bilder dienen nur zur Vergleichszwecken und können geringfügig abweichen.

**852991N**

Riemenscheiben-Ø [mm]: 125, Rippenanzahl: 8, Spannung [V]: 24,



**852992N**

Riemenscheiben-Ø [mm]: 112, Rippenanzahl: 6, Spannung [V]: 12,



**852993N**

Riemenscheiben-Ø [mm]: 119, Rippenanzahl: 8, Spannung [V]: 12,



**852994N**

Riemenscheiben-Ø [mm]: 118, Rippenanzahl: 1, Spannung [V]: 12,



**852995N**  
Riemenscheiben-Ø [mm]: 125, Rippenanzahl: 8, Spannung [V]: 12,



**852996N**  
Riemenscheiben-Ø [mm]: 119, Rippenanzahl: 10, Spannung [V]: 12,



**853087N**  
Riemenscheiben-Ø [mm]: 133, Rippenanzahl: 1, Spannung [V]: 24,



**853131N**  
Riemenscheiben-Ø [mm]: 130, Rippenanzahl: 1, Spannung [V]: 24,



**853132N**  
Riemenscheiben-Ø [mm]: 120, Rippenanzahl: 4, Spannung [V]: 12,



**853133N**  
Riemenscheiben-Ø [mm]: 120, Rippenanzahl: 4, Spannung [V]: 12,

Bilder dienen nur zur Vergleichszwecken und können geringfügig abweichen.



**853134N**

Riemenscheiben-Ø [mm]: 144, Rippenanzahl: 8, Spannung [V]: 12,



**853135N**

Riemenscheiben-Ø [mm]: 152, Rippenanzahl: 8, Spannung [V]: 12,

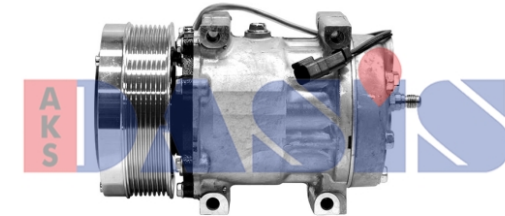

Bilder dienen nur zur Vergleichszwecken und können geringfügig abweichen.

**853136N**

Riemenscheiben-Ø [mm]: 137, Rippenanzahl: 8, Spannung [V]: 12,



**858020N**

Riemenscheiben-Ø [mm]: 132, Rippenanzahl: 2, Spannung [V]: 12, Zylinderkopf-ID (Kompressor): JD,

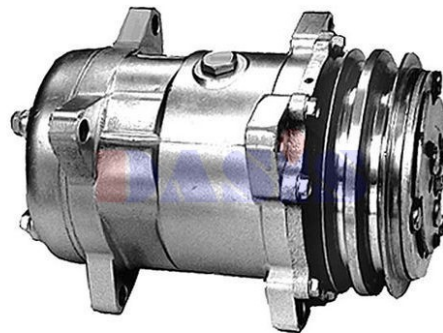

Bilder dienen nur zu Vergleichszwecken und können geringfügig abweichen.

**858453N**

Riemenscheiben-Ø [mm]: 132, Rippenanzahl: 2, Spannung [V]: 12,



**858454N**

Riemenscheiben-Ø [mm]: 132, Rippenanzahl: 2, Spannung [V]: 12, Zylinderkopf-ID (Kompressor): M,



**858456N**

Riemenscheiben-Ø [mm]: 135, Rippenzahl: 2, Spannung [V]: 12,

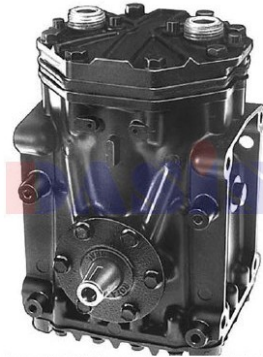

*Bilder dienen nur zu Vergleichszwecken und können geringfügig abweichen.*

**858477T**

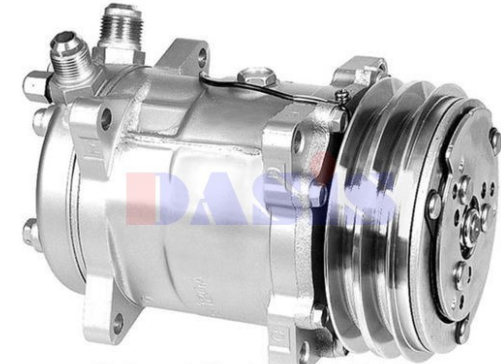

*Bilder dienen nur zu Vergleichszwecken und können geringfügig abweichen.*

**858485N**

Riemenscheiben-Ø [mm]: 132, Rippenzahl: 2, Spannung [V]: 12, Zylinderkopf-ID (Kompressor): B,



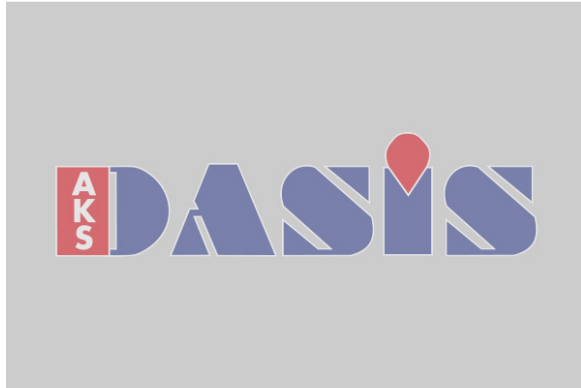

420004N



420007N

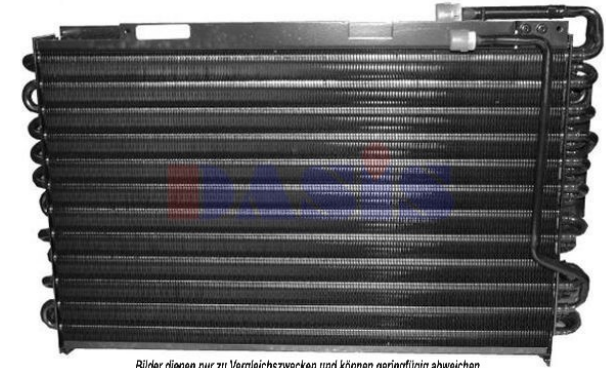

*Bilder dienen nur zu Vergleichszwecken und können geringfügig abweichen.*

420008N



*Bilder dienen nur zu Vergleichszwecken und können geringfügig abweichen.*

420009N

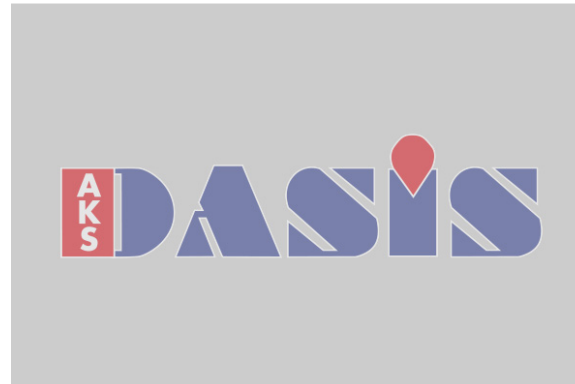

420011N



*Bilder dienen nur zur Vergleichszwecken und können geringfügig abweichen.*

420013N



420014N



420015N

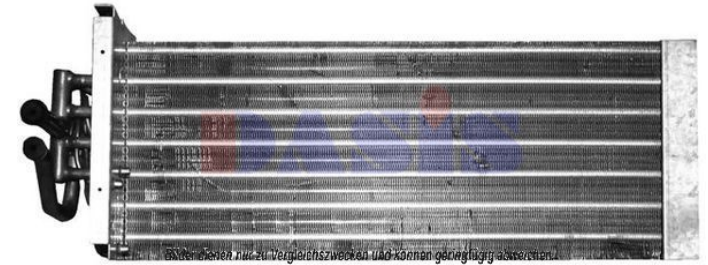

420016N

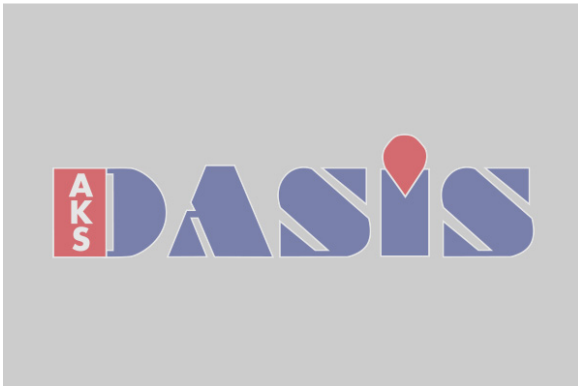

420017N



420018N



420019N



*Bilder dienen nur zu Vergleichszwecken und können geringfügig abweichen.*

**420021N**



*Bilder dienen nur zu Vergleichszwecken und können geringfügig abweichen.*

**420022N**

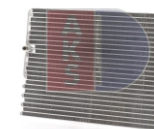

**420023N**



**420024N**



**420025N**



**420026N**



420027N

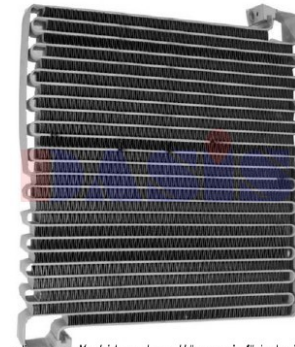

*Bilder dienen nur zu Vergleichszwecken und können geringfügig abweichen.*

420028N

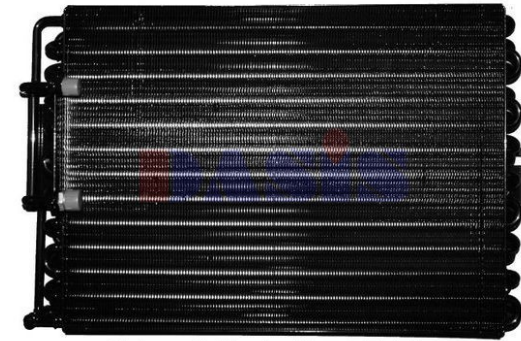

*Bilder dienen nur zu Vergleichszwecken und können geringfügig abweichen.*

420029N

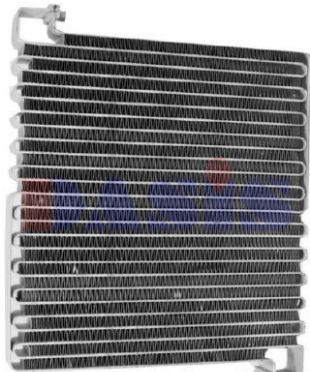

*Bilder dienen nur zu Vergleichszwecken und können geringfügig abweichen.*

420031N



*Bilder dienen nur zu Vergleichszwecken und können geringfügig abweichen.*

420032N



420033N



*Bilder dienen nur zu Vergleichszwecken und können geringfügig abweichen.*

**420034N**

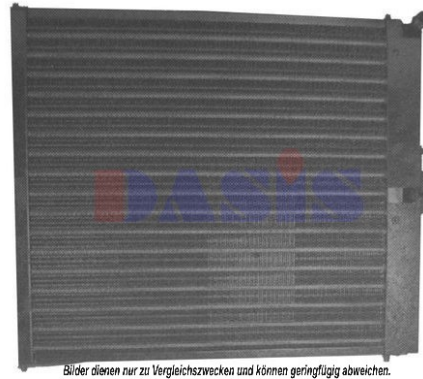

*Bilder dienen nur zu Vergleichszwecken und können geringfügig abweichen.*

**420035N**

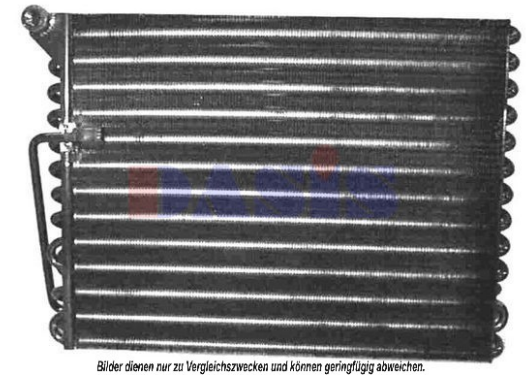

*Bilder dienen nur zu Vergleichszwecken und können geringfügig abweichen.*

**420036N**



*Bilder dienen nur zu Vergleichszwecken und können geringfügig abweichen.*

**420037N**



*Bilder dienen nur zu Vergleichszwecken und können geringfügig abweichen.*

**420038N**



*Bilder dienen nur zu Vergleichszwecken und können geringfügig abweichen.*

**420039N**



420040N

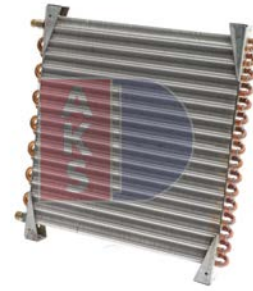

420041N



420042N

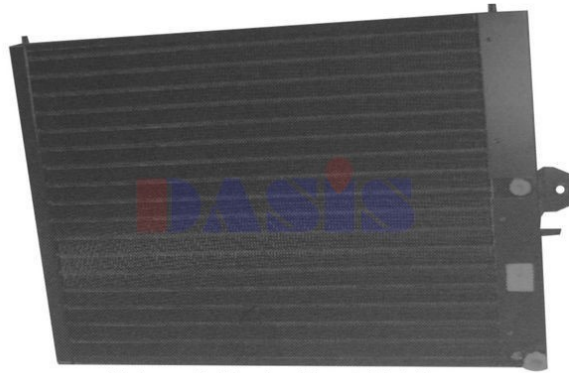

*Bilder dienen nur zu Vergleichszwecken und können geringfügig abweichen.*

420043N

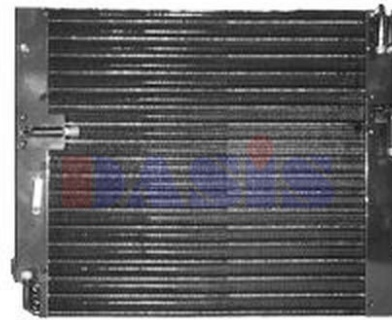

*Bilder dienen nur zu Vergleichszwecken und können geringfügig abweichen.*

420044N



420045N

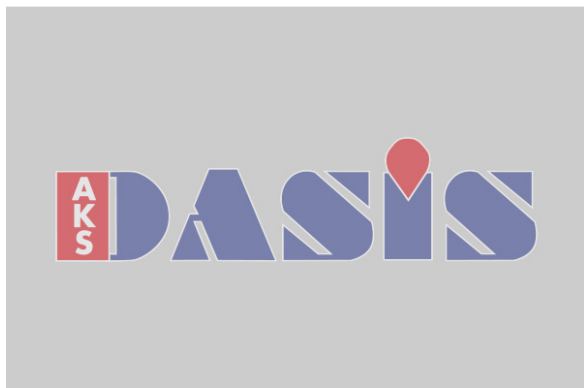

420046N

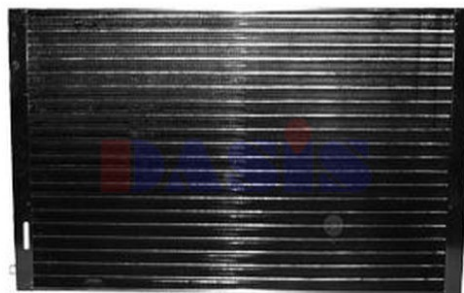

*Bilder dienen nur zu Vergleichszwecken und können geringfügig abweichen.*

420047N



*Bilder dienen nur zu Vergleichszwecken und können geringfügig abweichen.*

420048N



420049N



*Bilder dienen nur zu Vergleichszwecken und können geringfügig abweichen.*

420050N

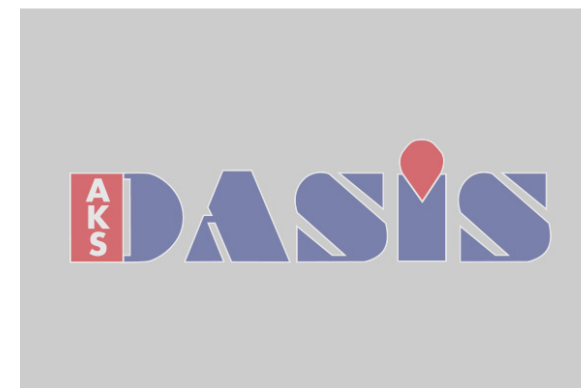

420051N



420052N



420053N



420054N



420055N



*Bilder dienen nur zu Vergleichszwecken und können geringfügig abweichen.*

420056N



422001N





422002N



422003N

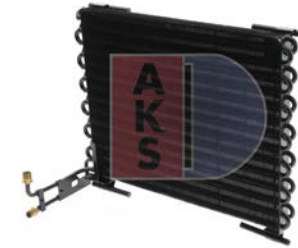

422004N



422005N



422006N



422007N

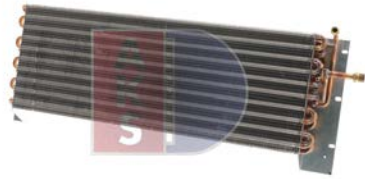

422008N



422009N

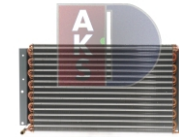

422010N



*Bilder dienen nur zu Vergleichszwecken und können geringfügig abweichen.*

422011N



422012N



422013N



422014N

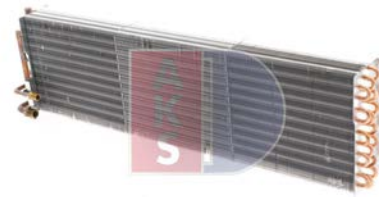

422015N



422016N



422017N



*Bilder dienen nur zu Vergleichszwecken und können geringfügig abweichen.*

422018N



*Bilder dienen nur zu Vergleichszwecken und können geringfügig abweichen.*

422019N



Bilder dienen nur zu Vergleichszwecken und können geringfügig abweichen.

422020N



422021N

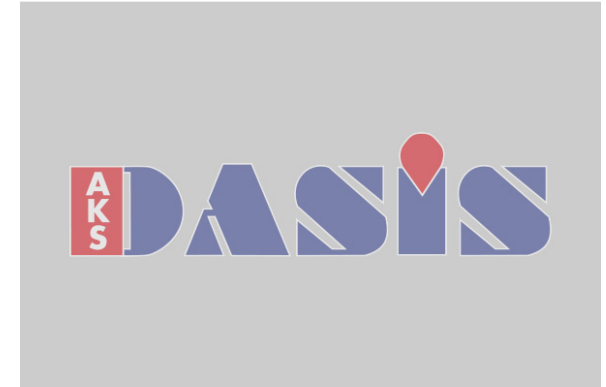

422023N

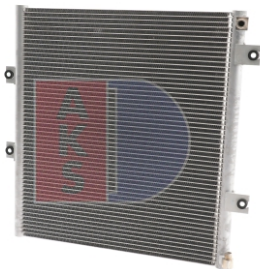

422024N

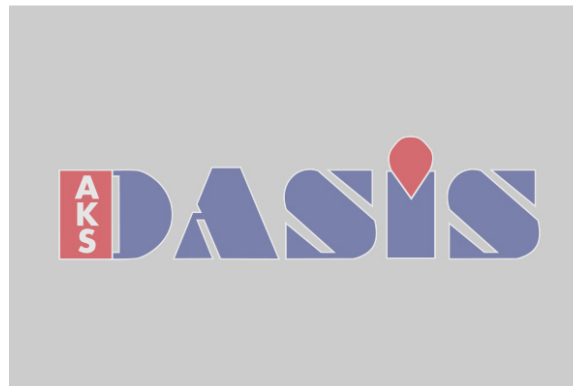

422025N



422027N



Bilder dienen nur zur Vergleichszwecken und können geringfügig abweichen.

422030N



422031N



422032N



422038N

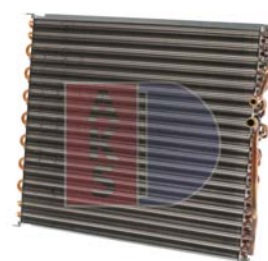

422040N



422043N



Bilder dienen nur zur Vergleichszwecken und können geringfügig abweichen.

422045N

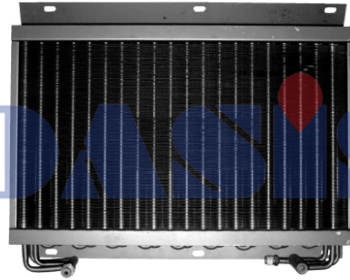

Bilder dienen nur zur Vergleichszwecken und können geringfügig abweichen.

422055N



422056N



422070N



422071N



422072N



422073N



422075N



422083N



422088N  
Netzmaße: 440x440x50,



Bilder dienen nur zur Vergleichszwecken und können geringfügig abweichen.

422089N



Bilder dienen nur zur Vergleichszwecken und können geringfügig abweichen.

422090N



Bilder dienen nur zur Vergleichszwecken und können geringfügig abweichen.

422091N



Bilder dienen nur zur Vergleichszwecken und können geringfügig abweichen.

422092N

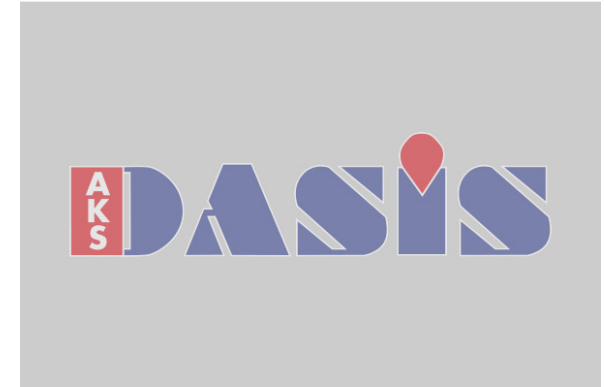

422093N



422097N

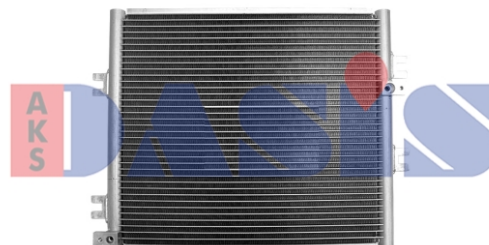

Bilder dienen nur zur Vergleichszwecken und können geringfügig abweichen.

422098N

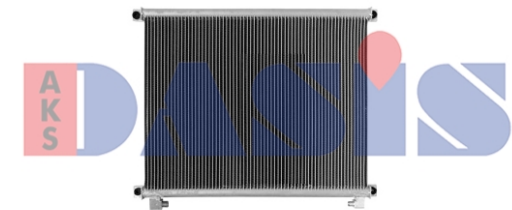

Bilder dienen nur zur Vergleichszwecken und können geringfügig abweichen.

422099N





422100N

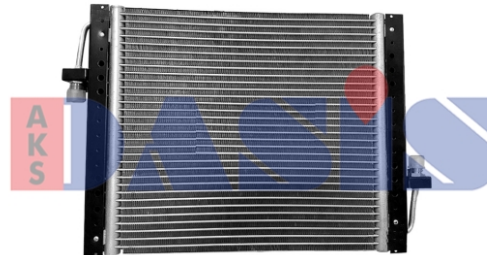

Bilder dienen nur zur Vergleichszwecken und können geringfügig abweichen.

422101N

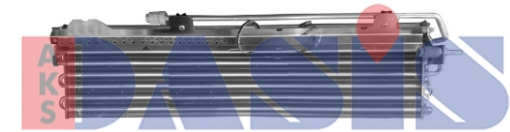

Bilder dienen nur zur Vergleichszwecken und können geringfügig abweichen.

422102N

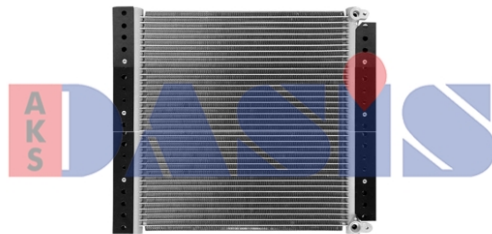

Bilder dienen nur zur Vergleichszwecken und können geringfügig abweichen.

422103N

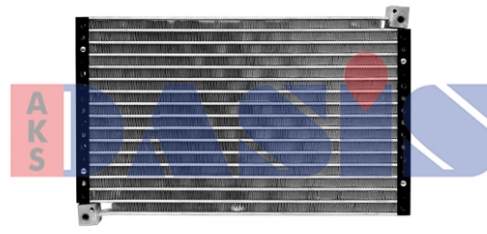

Bilder dienen nur zur Vergleichszwecken und können geringfügig abweichen.

422104N

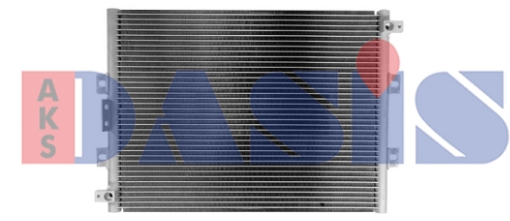

Bilder dienen nur zur Vergleichszwecken und können geringfügig abweichen.

422105N



Bilder dienen nur zur Vergleichszwecken und können geringfügig abweichen.

422106N



422107N

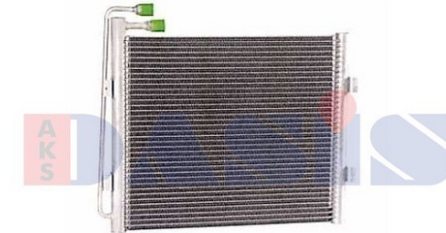

Bilder dienen nur zur Vergleichszwecken und können geringfügig abweichen.

442004N

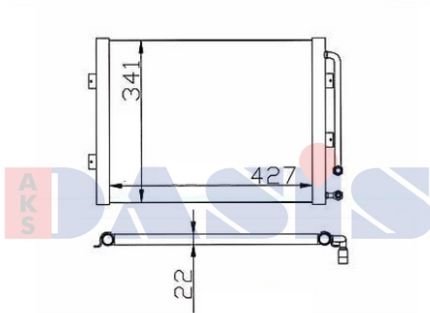

Bilder dienen nur zur Vergleichszwecken und können geringfügig abweichen.

442005N

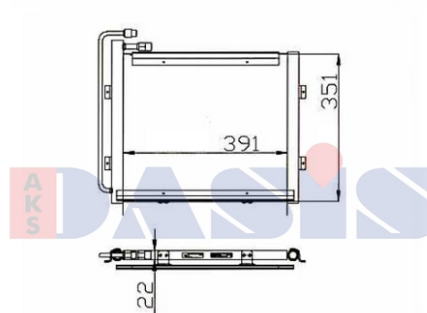

Bilder dienen nur zur Vergleichszwecken und können geringfügig abweichen.

442007N



442008N



Bilder dienen nur zu Vergleichszwecken und können geringfügig abweichen.

442009N



Bilder dienen nur zu Vergleichszwecken und können geringfügig abweichen.

442010N

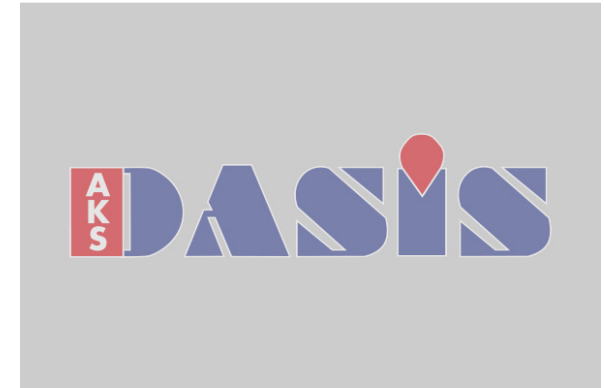

442014N



Bilder dienen nur zur Vergleichszwecken und können geringfügig abweichen.

452001N

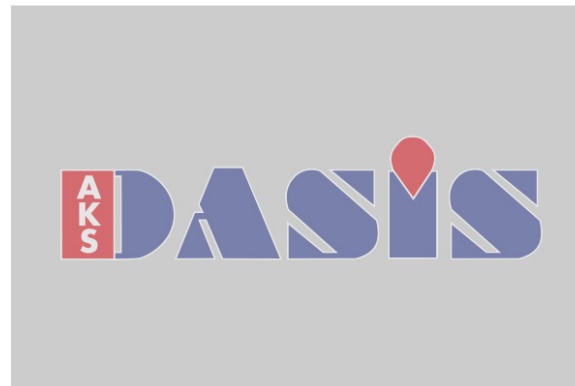

452002N

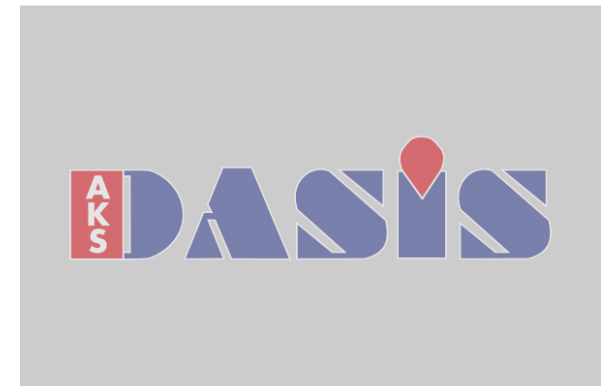

452003N

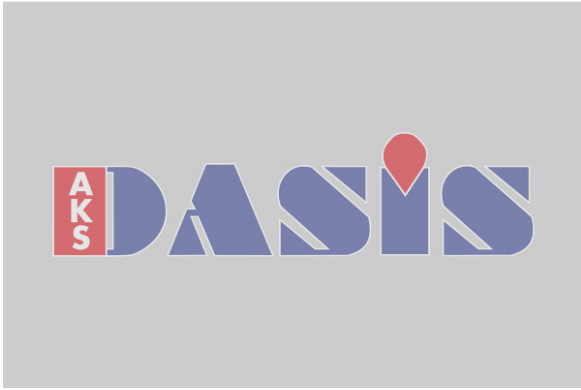

452004N

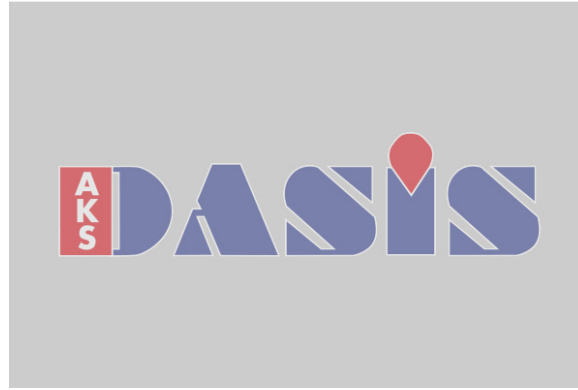

452005N

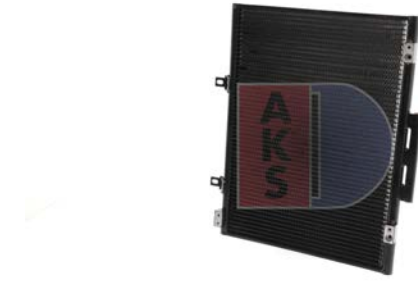

452006N

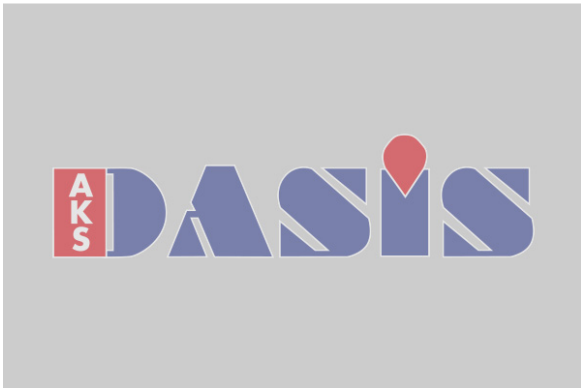

452007N

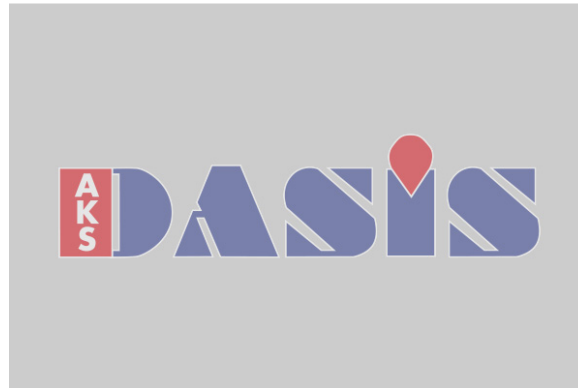

452008N



452009N



452010N

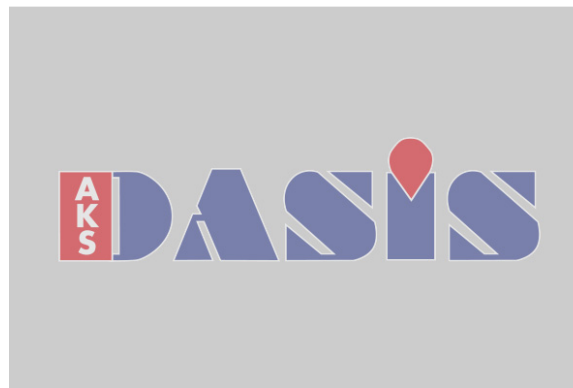

452012N



Bilder dienen nur zur Vergleichszwecken und können geringfügig abweichen.

452013N



452014N



Bilder dienen nur zur Vergleichszwecken und können geringfügig abweichen.

452015N

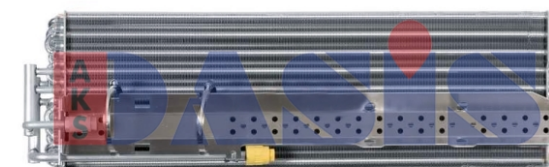

Bilder dienen nur zur Vergleichszwecken und können geringfügig abweichen.

452016N

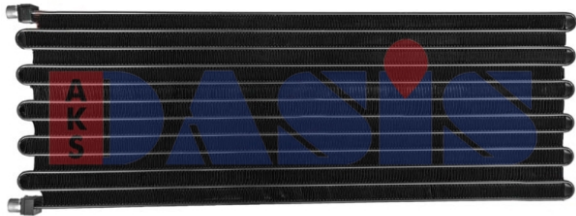

Bilder dienen nur zur Vergleichszwecken und können geringfügig abweichen.

452017N



Bilder dienen nur zur Vergleichszwecken und können geringfügig abweichen.

452020N

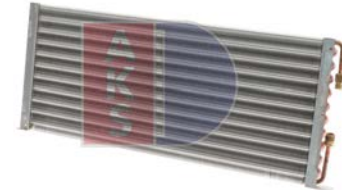

452021N

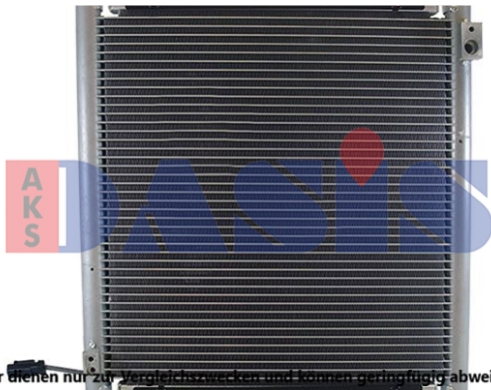

Bilder dienen nur zur Vergleichszwecken und können geringfügig abweichen.

452022N

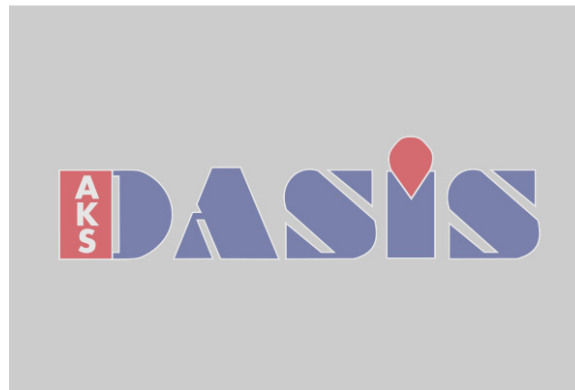

452023N

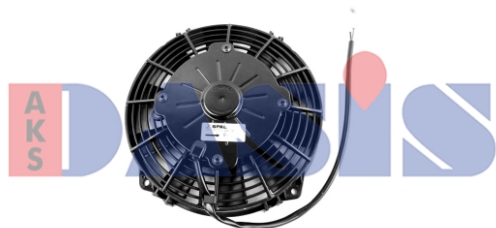

Bilder dienen nur zur Vergleichszwecken und können geringfügig abweichen.

**870238N**

Außendurchmesser [mm]: 210, Innendurchmesser [mm]:  
190,



**750004N**

**Ausschaltpunkt [°C]: -3, Einschaltpunkt [°C]: 0,  
Kapillarrohrlänge [mm]: 914, Spannung [V]: 12, Spezifikation: Regler AC,**



*Bilder dienen nur zu Vergleichszwecken und können geringfügig abweichen.*

**750005N**

**Ausschaltpunkt [°C]: -3, Einschaltpunkt [°C]: 0,  
Kapillarrohrlänge [mm]: 1210, Spezifikation: Regler AC,**



**750013N**

**Ausschaltpunkt [°C]: -2, Einschaltpunkt [°C]: 1,  
Kapillarrohrlänge [mm]: 1828, Spezifikation: Regler AC,**



**901812N**

**Kapillarrohrlänge [mm]: 609, Spezifikation: Regler AC,**

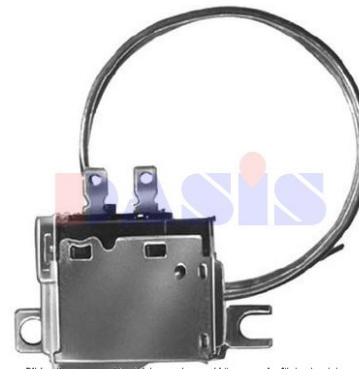

*Bilder dienen nur zu Vergleichszwecken und können geringfügig abweichen.*

**901813N**

**Ausschaltpunkt [°C]: -4, Einschaltpunkt [°C]: 2,  
Kapillarrohrlänge [mm]: 457, Spezifikation: Regler AC,**



**901825N**

**Ausschaltpunkt [°C]: -0, Einschaltpunkt [°C]: 3,  
Kapillarrohrlänge [mm]: 609, Spannung [V]: 12, Spezifikation: Regler AC,**



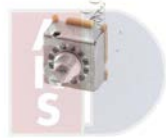

**900076N**

**Ausstattungsvariante: 3 Schaltstufen,**



**900194N**

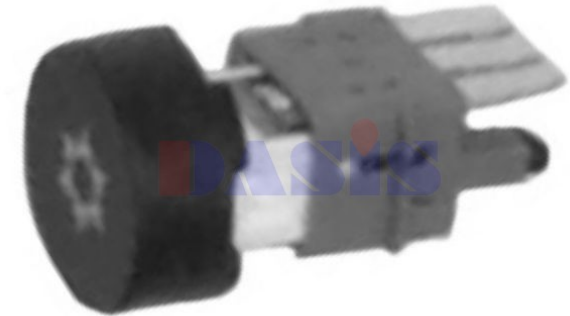

*Bilder dienen nur zu Vergleichszwecken und können geringfügig abweichen.*

**900744N**

**Ausstattungsvariante: 3 Schaltstufen,**



*Bilder dienen nur zu Vergleichszwecken und können geringfügig abweichen.*

**901060N**

**Ausstattungsvariante: 3 Schaltstufen,**



*Bilder dienen nur zu Vergleichszwecken und können geringfügig abweichen.*

**901219N**

**Ausstattungsvariante: 3 Schaltstufen,**



**901263N**

**Ausstattungsvariante: 3 Schaltstufen,**



*Bilder dienen nur zu Vergleichszwecken und können geringfügig abweichen.*

**901653N**

**Ausstattungsvariante: 3 Schaltstufen,**



*Bilder dienen nur zu Vergleichszwecken und können geringfügig abweichen.*

**901710N**

**Ausstattungsvariante: 4 Schaltstufen,**



**901761N**



**901814N**



**901819N**



Bilder dienen nur zur Vergleichszwecken und können geringfügig abweichen.

746343N



Bilder dienen nur zur Vergleichszwecken und können geringfügig abweichen.

750997N



Bilder dienen nur zur Vergleichszwecken und können geringfügig abweichen.

752079N



Bilder dienen nur zur Vergleichszwecken und können geringfügig abweichen.

752080N

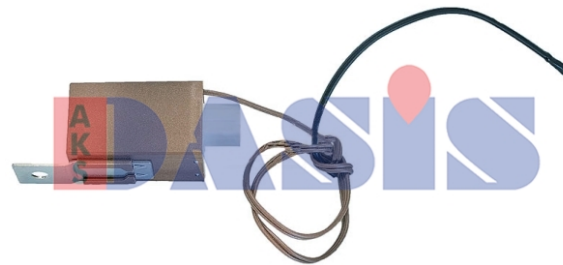

Bilder dienen nur zur Vergleichszwecken und können geringfügig abweichen.

900195N



Bilder dienen nur zur Vergleichszwecken und können geringfügig abweichen.

900196N



Bilder dienen nur zur Vergleichszwecken und können geringfügig abweichen.

900197N



Bilder dienen nur zur Vergleichszwecken und können geringfügig abweichen.

900200N



**800010N**  
Außendurchmesser [mm]: 76,



**800015N**  
Außendurchmesser [mm]: 102,



**800017N**  
Außendurchmesser [mm]: 102,



**800018N**  
Außendurchmesser [mm]: 102,



*Bilder dienen nur zu Vergleichszwecken und können geringfügig abweichen.*

**800032N**  
Außendurchmesser [mm]: 76,



**800043N**  
Außendurchmesser [mm]: 10,



**800045N**  
 Außendurchmesser [mm]: 60,



**800046N**  
 Außendurchmesser [mm]: 102,



**800049N**  
 Außendurchmesser [mm]: 76,



**800051N**

*Bilder dienen nur zu Vergleichszwecken und können geringfügig abweichen.*



**800052N**  
 Außendurchmesser [mm]: 65,



**800054N**  
 Außendurchmesser [mm]: 102,



**800055N**  
Außendurchmesser [mm]: 76,



**800056N**  
Außendurchmesser [mm]: 102,



**800064N**  
Außendurchmesser [mm]: 76,



**800065N**  
Außendurchmesser [mm]: 76,



**800066N**  
Außendurchmesser [mm]: 102,



**800067N**  
Außendurchmesser [mm]: 102,

*Bilder dienen nur zu Vergleichszwecken und können geringfügig abweichen.*



**800118N**  
 Außendurchmesser [mm]: 45, Länge [mm]: 298,



**800152N**  
 Außendurchmesser [mm]: 80,



**800153N**  
 Außendurchmesser [mm]: 70,



**800154N**  
 Außendurchmesser [mm]: 62,



**800155N**  
 Außendurchmesser [mm]: 76,



**800163N**  
 Außendurchmesser [mm]: 102,





**800173N**  
Außendurchmesser [mm]: 102,



**800176N**  
Außendurchmesser [mm]: 76,



**800178N**  
Außendurchmesser [mm]: 102,



**800198N**  
Außendurchmesser [mm]: 76,



**800201N**  
Außendurchmesser [mm]: 76,



**800204N**  
Außendurchmesser [mm]: 76,



**800215N**  
 Außendurchmesser [mm]: 76,



*Bilder dienen nur zu Vergleichszwecken und können geringfügig abweichen.*

**800224N**  
 Außendurchmesser [mm]: 63,



*Bilder dienen nur zu Vergleichszwecken und können geringfügig abweichen.*

**800244N**  
 Außendurchmesser [mm]: 63,



*Bilder dienen nur zu Vergleichszwecken und können geringfügig abweichen.*

**800248N**  
 Außendurchmesser [mm]: 63,



**800279N**  
 Außendurchmesser [mm]: 63,



*Bilder dienen nur zu Vergleichszwecken und können geringfügig abweichen.*

**800296N**  
 Außendurchmesser [mm]: 76,



**800340N**  
Außendurchmesser [mm]: 89,



*Bilder dienen nur zu Vergleichszwecken und können geringfügig abweichen.*

**800365N**  
Außendurchmesser [mm]: 76,



**800367N**  
Außendurchmesser [mm]: 75,



**800369N**  
Außendurchmesser [mm]: 76,



**800371N**  
Außendurchmesser [mm]: 65,



*Bilder dienen nur zu Vergleichszwecken und können geringfügig abweichen.*

**800372N**  
Außendurchmesser [mm]: 76,



**800373N**  
 Außendurchmesser [mm]: 76,



**800375N**  
 Außendurchmesser [mm]: 76,



**800377N**  
 Außendurchmesser [mm]: 76,



*Bilder dienen nur zu Vergleichszwecken und können geringfügig abweichen.*

**800383N**  
 Außendurchmesser [mm]: 76,



*Bilder dienen nur zu Vergleichszwecken und können geringfügig abweichen.*

**800386N**  
 Außendurchmesser [mm]: 76,



*Bilder dienen nur zu Vergleichszwecken und können geringfügig abweichen.*

**800392N**  
 Außendurchmesser [mm]: 76,



**800393N**  
Außendurchmesser [mm]: 61,



**800396N**  
Außendurchmesser [mm]: 80,



*Bilder dienen nur zu Vergleichszwecken und können geringfügig abweichen.*

**800397N**  
Außendurchmesser [mm]: 70,

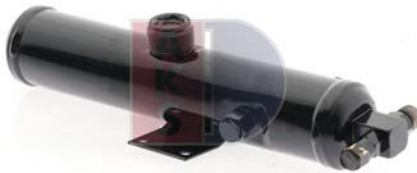

**800432N**  
Außendurchmesser [mm]: 50,



*Bilder dienen nur zu Vergleichszwecken und können geringfügig abweichen.*

**800433N**  
Außendurchmesser [mm]: 70,



**800529N**  
Außendurchmesser [mm]: 102,



**800531N**  
Außendurchmesser [mm]: 76,



*Bilder dienen nur zu Vergleichszwecken und können geringfügig abweichen.*

**800532N**  
Außendurchmesser [mm]: 76,



**800533N**  
Außendurchmesser [mm]: 102,



**800534N**  
Außendurchmesser [mm]: 76,



**800535N**  
Außendurchmesser [mm]: 70,



**800536N**  
Außendurchmesser [mm]: 89,



**800537N**  
Außendurchmesser [mm]: 76,



*Bilder dienen nur zu Vergleichszwecken und können geringfügig abweichen.*

**800538N**  
Außendurchmesser [mm]: 102,



*Bilder dienen nur zu Vergleichszwecken und können geringfügig abweichen.*

**800539N**  
Außendurchmesser [mm]: 102,



*Bilder dienen nur zu Vergleichszwecken und können geringfügig abweichen.*

**800540N**  
Außendurchmesser [mm]: 102,



**800541N**  
Außendurchmesser [mm]: 76,



**800542N**  
Außendurchmesser [mm]: 102,



**800543N**  
Außendurchmesser [mm]: 70,



**800544N**  
Außendurchmesser [mm]: 65,



*Bilder dienen nur zu Vergleichszwecken und können geringfügig abweichen.*

**800545N**  
Außendurchmesser [mm]: 76,



**800546N**  
Außendurchmesser [mm]: 76,



**800548N**  
Außendurchmesser [mm]: 76,



**800549N**  
Außendurchmesser [mm]: 76,





**800552N**  
Außendurchmesser [mm]: 76,



**800553N**  
Außendurchmesser [mm]: 70,



**800555N**  
Außendurchmesser [mm]: 89,



*Bilder dienen nur zu Vergleichszwecken und können geringfügig abweichen.*

**800557N**  
Außendurchmesser [mm]: 89,



*Bilder dienen nur zu Vergleichszwecken und können geringfügig abweichen.*

**800558N**  
Außendurchmesser [mm]: 50,



**800559N**  
Außendurchmesser [mm]: 76,



**800561N**  
 Außendurchmesser [mm]: 45,



**800562N**  
 Außendurchmesser [mm]: 76,

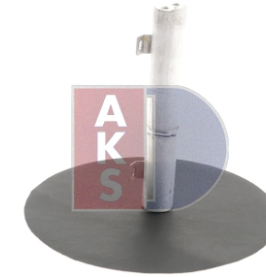

**800630N**  
 Außendurchmesser [mm]: 63,



**800677N**  
 Außendurchmesser [mm]: 10,



Bilder dienen nur zur Vergleichszwecken und können geringfügig abweichen.

**800678N**



Bilder dienen nur zur Vergleichszwecken und können geringfügig abweichen.

**800679N**

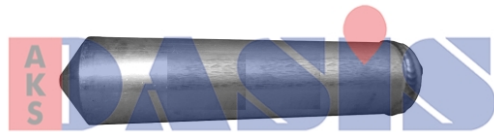

Bilder dienen nur zur Vergleichszwecken und können geringfügig abweichen.

**800707N**

Außendurchmesser [mm]: 60, Länge [mm]: 260,

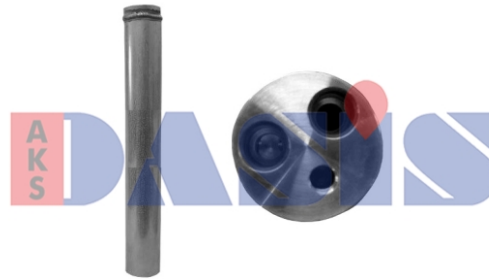

Bilder dienen nur zur Vergleichszwecken und können geringfügig abweichen.

**800708N**

Außendurchmesser [mm]: 40, Länge [mm]: 297,



Bilder dienen nur zur Vergleichszwecken und können geringfügig abweichen.

**800709N**

Außendurchmesser [mm]: 76, Länge [mm]: 229,

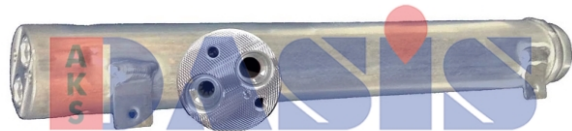

Bilder dienen nur zur Vergleichszwecken und können geringfügig abweichen.

**800961N**



Bilder dienen nur zur Vergleichszwecken und können geringfügig abweichen.

**800962N**

Außendurchmesser [mm]: 63,



Bilder dienen nur zur Vergleichszwecken und können geringfügig abweichen.

**800963N**

Außendurchmesser [mm]: 35, Länge [mm]: 267,



Bilder dienen nur zur Vergleichszwecken und können geringfügig abweichen.

**800964N**

Außendurchmesser [mm]: 64, Länge [mm]: 195,



**800965N**

Außendurchmesser [mm]: 76,



**800966N**

Außendurchmesser [mm]: 60,

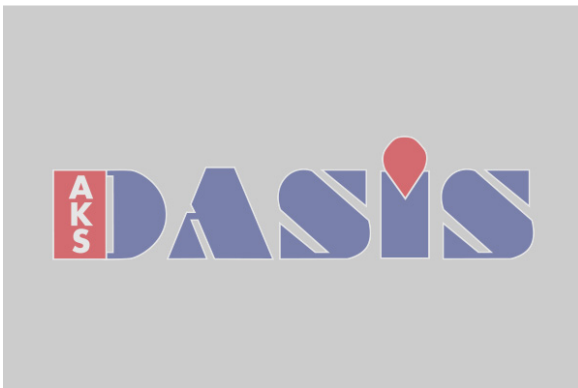

**800967N**



**801010N**

Außendurchmesser [mm]: 76,



**801100N**

Außendurchmesser [mm]: 51,



**801240N**  
Außendurchmesser [mm]: 67,



**801580N**  
Außendurchmesser [mm]: 89,



*Bilder dienen nur zu Vergleichszwecken und können geringfügig abweichen.*

**801720N**



**802110N**  
Außendurchmesser [mm]: 63,



**802240N**  
Außendurchmesser [mm]: 76,



**802300N**  
Außendurchmesser [mm]: 76,



**802310N**  
 Außendurchmesser [mm]: 75,



**802590N**  
 Außendurchmesser [mm]: 76,



**802780N**  
 Außendurchmesser [mm]: 63,



**803510N**  
 Außendurchmesser [mm]: 45,



**803972N**  
 Außendurchmesser [mm]: 76,



**805002N**  
 Außendurchmesser [mm]: 64, Länge [mm]: 156,



820017N



820019N

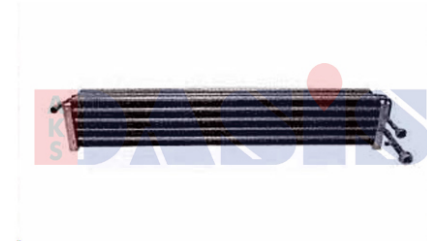

*Bilder dienen nur zu Vergleichszwecken und können geringfügig abweichen.*

820061N

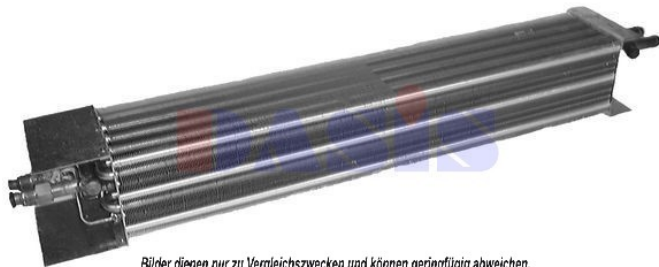

*Bilder dienen nur zu Vergleichszwecken und können geringfügig abweichen.*

820067N



*Bilder dienen nur zu Vergleichszwecken und können geringfügig abweichen.*

820070N



820071N



Bilder dienen nur zu Vergleichszwecken und können geringfügig abweichen.

**820079N**



**820080N**  
Einbaudicke [mm]: 146,



Bilder dienen nur zu Vergleichszwecken und können geringfügig abweichen.

**820084N**

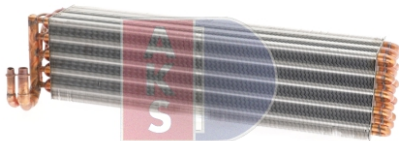

**820091N**



**820092N**



**820094N**



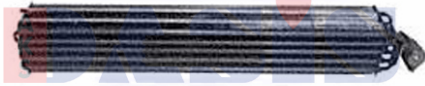

Bilder dienen nur zu Vergleichszwecken und können geringfügig abweichen.

820097N



Bilder dienen nur zu Vergleichszwecken und können geringfügig abweichen.

820130N



Bilder dienen nur zu Vergleichszwecken und können geringfügig abweichen.

820150N

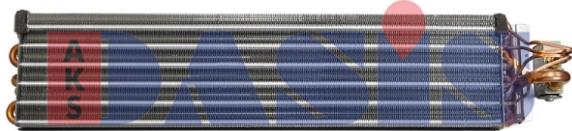

Bilder dienen nur zu Vergleichszwecken und können geringfügig abweichen.

820179N

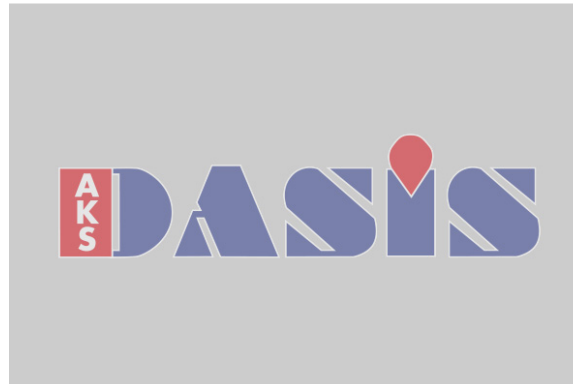

820205N



Bilder dienen nur zu Vergleichszwecken und können geringfügig abweichen.

820284N



820285N



820287N

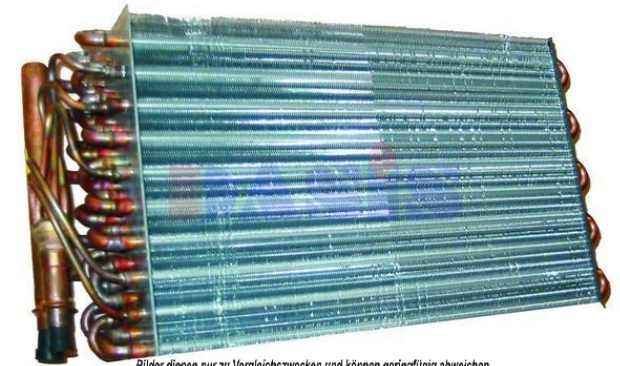

*Bilder dienen nur zu Vergleichszwecken und können geringfügig abweichen.*

820289N

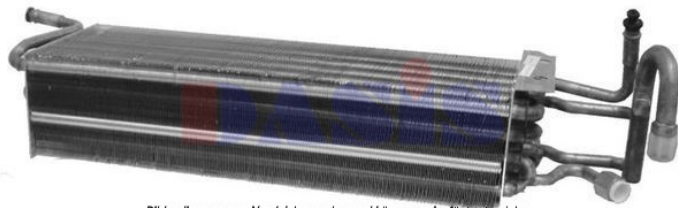

*Bilder dienen nur zu Vergleichszwecken und können geringfügig abweichen.*

820291N

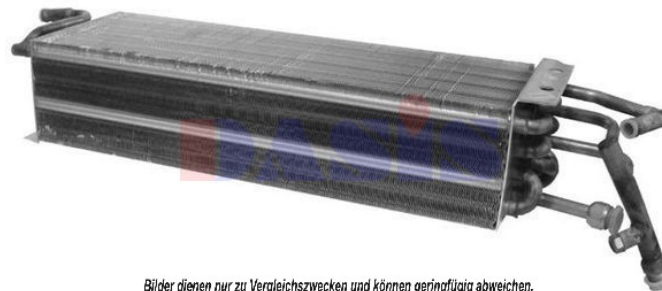

*Bilder dienen nur zu Vergleichszwecken und können geringfügig abweichen.*

820292N



*Bilder dienen nur zu Vergleichszwecken und können geringfügig abweichen.*

820295N



820298N



*Bilder dienen nur zu Vergleichszwecken und können geringfügig abweichen.*

820299N

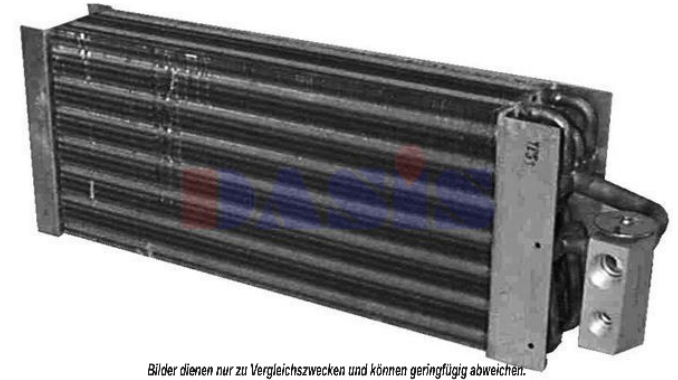

*Bilder dienen nur zu Vergleichszwecken und können geringfügig abweichen.*

820301N

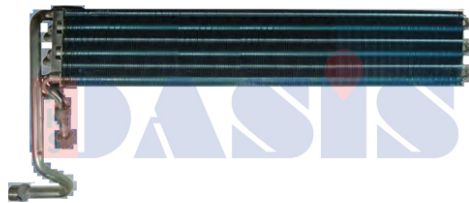

*Bilder dienen nur zu Vergleichszwecken und können geringfügig abweichen.*

820386N

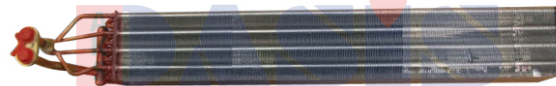

*Bilder dienen nur zu Vergleichszwecken und können geringfügig abweichen.*

820387N

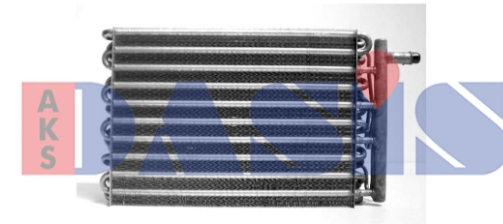

*Bilder dienen nur zur Vergleichszwecken und können geringfügig abweichen.*

820388N

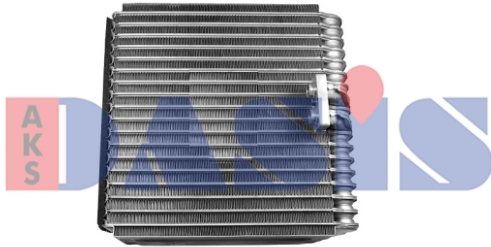

Bilder dienen nur zur Vergleichszwecken und können geringfügig abweichen.

820389N



Bilder dienen nur zur Vergleichszwecken und können geringfügig abweichen.

820390N



820391N



Bilder dienen nur zur Vergleichszwecken und können geringfügig abweichen.

820392N



Bilder dienen nur zur Vergleichszwecken und können geringfügig abweichen.

820393N

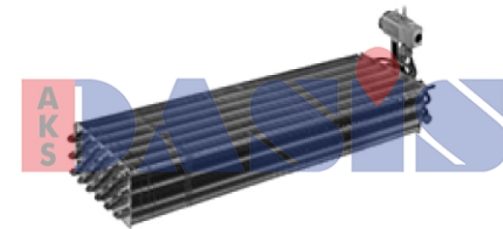

Bilder dienen nur zur Vergleichszwecken und können geringfügig abweichen.

820394N



820395N

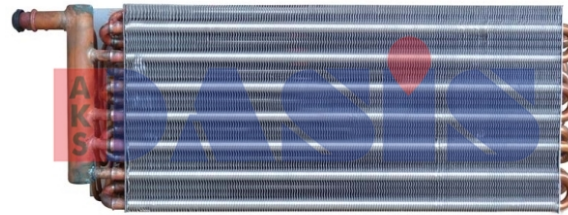

Bilder dienen nur zur Vergleichszwecken und können geringfügig abweichen.

820415N

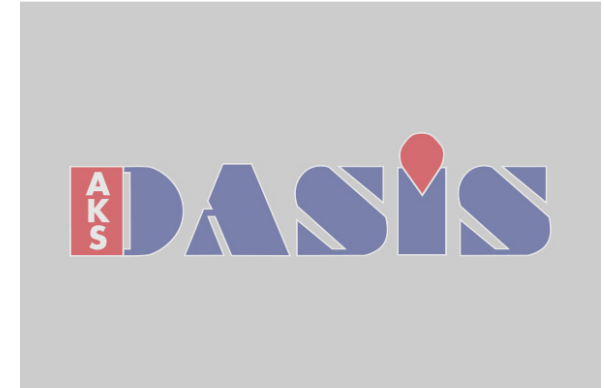

820416N



Bilder dienen nur zur Vergleichszwecken und können geringfügig abweichen.

820425N



Bilder dienen nur zur Vergleichszwecken und können geringfügig abweichen.

820426N

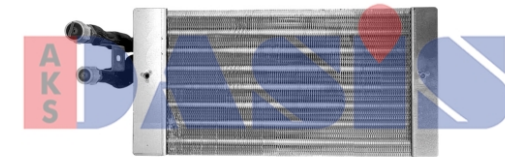

Bilder dienen nur zur Vergleichszwecken und können geringfügig abweichen.

820427N



820428N

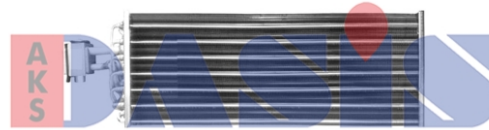

820429N

Bilder dienen nur zur Vergleichszwecken und können geringfügig abweichen.

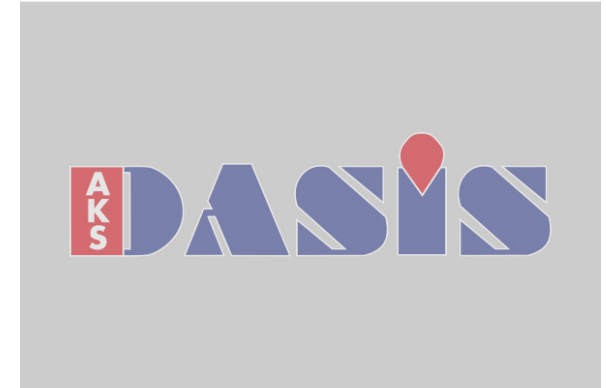

820992N



820993N



820994N

Bilder dienen nur zur Vergleichszwecken und können geringfügig abweichen.

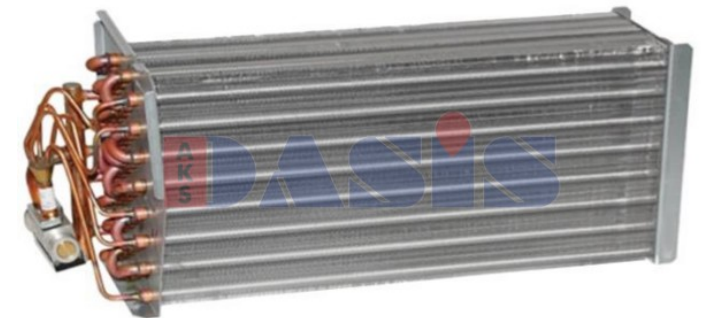

820995N

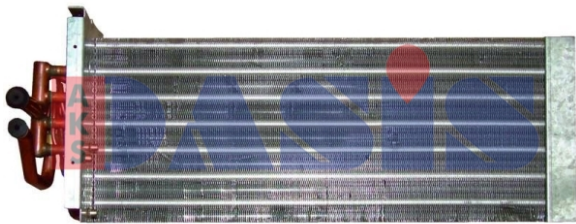

Bilder dienen nur zur Vergleichszwecken und können geringfügig abweichen.

820996N



820997N

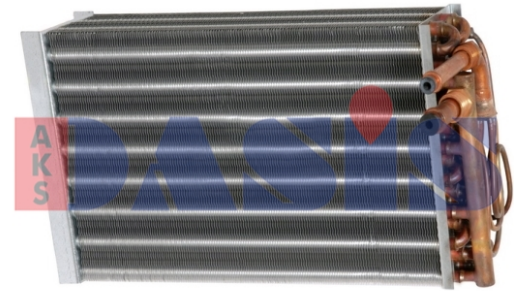

Bilder dienen nur zur Vergleichszwecken und können geringfügig abweichen.

820998N

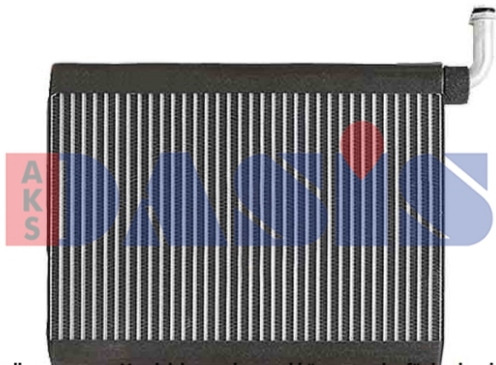

Bilder dienen nur zur Vergleichszwecken und können geringfügig abweichen.

821881N

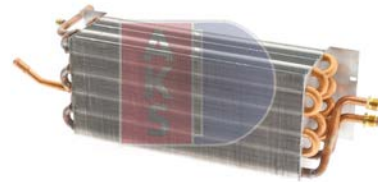

821882N



821883N



Bilder dienen nur zur Vergleichszwecken und können geringfügig abweichen.

821884N



Bilder dienen nur zur Vergleichszwecken und können geringfügig abweichen.

821885N

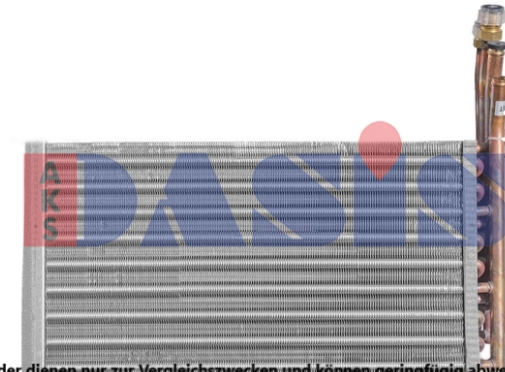

Bilder dienen nur zur Vergleichszwecken und können geringfügig abweichen.

821886N



Bilder dienen nur zur Vergleichszwecken und können geringfügig abweichen.

821887N



Bilder dienen nur zur Vergleichszwecken und können geringfügig abweichen.

821888N



821889N



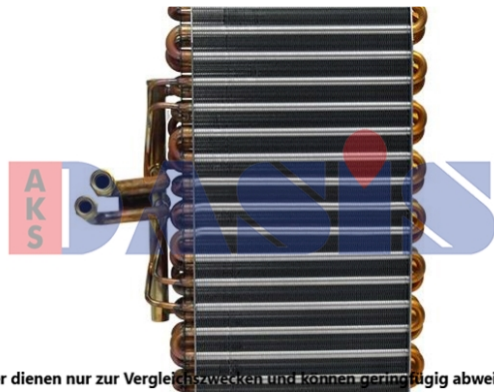

Bilder dienen nur zur Vergleichszwecken und können geringfügig abweichen.

821890N



821891N

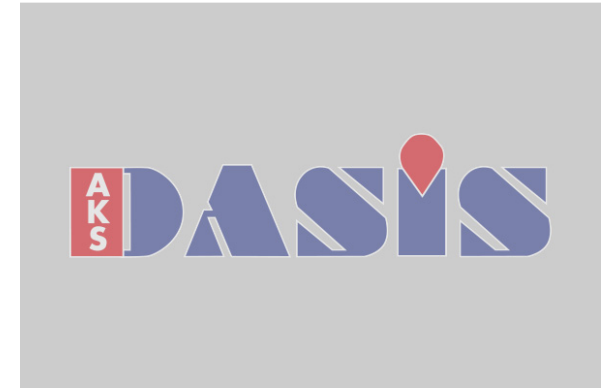

821892N

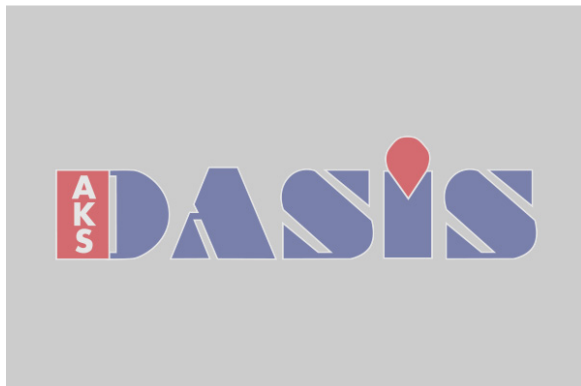

821893N

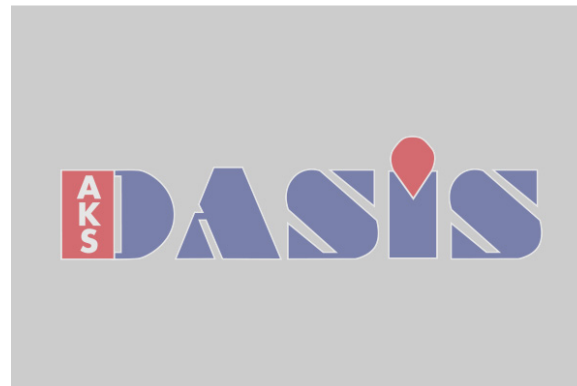

821894N



825005N



### AKS Dasis Online

Weitere Informationen rund um die Firma AKS Dasis und die von uns angebotenen Leistungen und Produkte finden Sie im Internet unter [www.dasis.de](http://www.dasis.de).

Neben ausführlichen Informationen rund um unser Unternehmen, bietet Ihnen unser mehrsprachiger Online-Shop Kühlungs- und Klimatisierungsartikel für Ihren PKW, NKW oder Ihre Landmaschine.

### Logistik

Guter Service braucht gute Verbindungen

Durch bundesweite modernste Logistik garantiert DASIS eine hohe Lieferfähigkeit in ganz Europa. Die Lieferung erfolgt aus zwei Auslieferungslagern in Deutschland.





**Ihr Spezialist für die Motorkühlung & Fahrzeugklimatisierung**

**AKS Dasis Dommermuth GmbH & Co. KG**

Auf dem Hahnenberg 14 | 56218 Mülheim-Kärlich  
Telefon: 02630 9401-0